

11 Line Bored Lock



Table of Contents

11 Line Bored Lock

Overview	3
Certifications	4
Technical Details	5
STC 55 Acoustic Door Systems	6
Lever and Rose Designs	7
Functions	8-9
Function Conversion Chart	10
Cylinders	11
Latches	12
Strikes	13
Tools & Misc.	14
Retrofit Option	15
Cylinder Options	16-17
Mechanical Options	18
Finishes, Packaging	19
How to Order	20
Architectural Specifications	21

MicroShield®

ASSA ABLOY Group companies offer MicroShield®, an anti-microbial coating for door hardware. MicroShield uses proven silver ion-based technology from Agion®, a leading provider of antimicrobial solutions, to stem the spread of bacteria and other microbes.

MicroShield® is a trademark of ASSA ABLOY Access and Egress Hardware Group, Inc.

MicroShield® Coating

- Revolutionary finish coating available on all SARGENT product lines, utilizes a silver-based antimicrobial compound from Agion Technologies
- As an integral part of the finish coating, MicroShield lasts for the life of the hardware
- MicroShield coating permanently suppresses the growth of bacteria, algae, fungus, mold and mildew. It is effective against a broad spectrum of bacteria.
- Non-toxic and completely safe. The Agion antimicrobial compound is EPA and NSF approved and FDA listed for use in medical and food preparation equipment.
- Applications: Anywhere there is need for a clean environment (hospitals, laboratories, schools, medical centers, daycare, food processing etc.)



The Agion antimicrobial is not intended as a substitute for good hygiene. Coated products must still be cleaned to ensure the surfaces will be free of destructive microbes. ASSA ABLOY makes no representations or warranties, express or implied, as to the efficacy of the Agion antimicrobial. A copy of the Agion warranty is available upon request. Agion is a registered trademark of Agion Technologies, Inc., Wakefield, MA, USA.

On the Cover

11G05 x OL x 26D Entrance Lock

Overview

11 Line Bored Lock

The SARGENT 11 Line has a unique, T-Zone construction providing strength and durability for the most demanding applications such as schools and hospitals. This is accomplished by true interlocking between the lockbody and the latchbolt.

Patent pending and/or patent www.assaabloydss.com/patents

T-Zone Construction

Direct linkage with fixed alignment between the hub and the latchbolt is the best construction for quietly and effectively operating the latchbolt. For this reason, SARGENT developed the interlocking aligning and latch tubes, which form a rugged torque resistant "T" in the critical twist area. This "T-Zone" construction, combined with long lasting components, makes 11 Line bored lock outstanding!

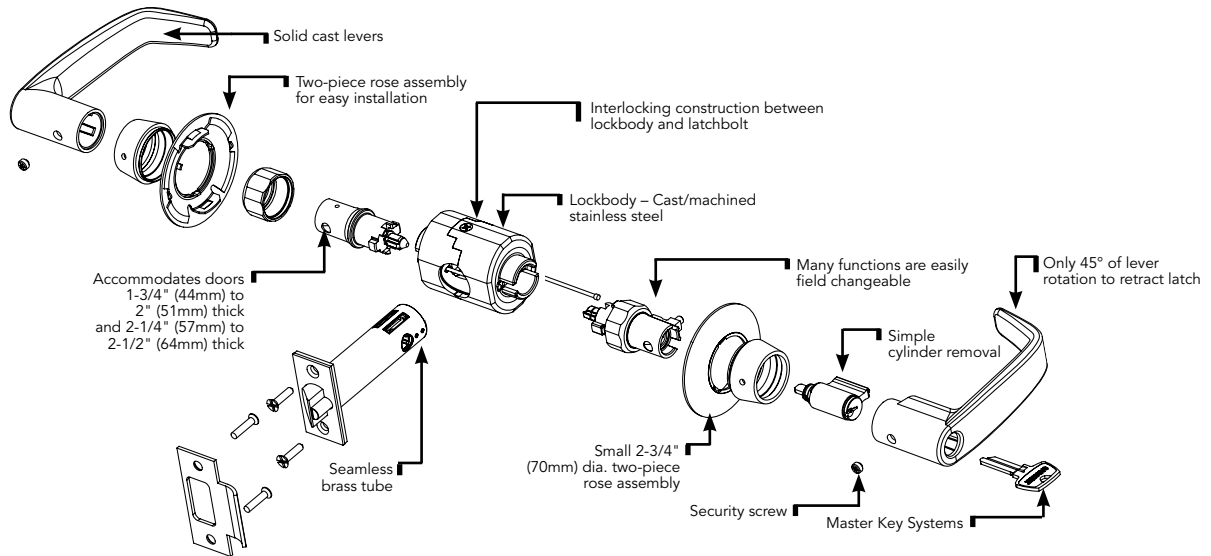

Applications

- High traffic areas – offices, public buildings, hospitals
- High abuse areas – institutions, schools, retail
- Anywhere that requires the contemporary look of a small rose and durability that exceeds Grade 1 standards

Innovation

- Patented construction with true interlocking between the lockbody and the latchbolt provides strength and durability for the most demanding applications

Copyright © 2007-2021, SARGENT Manufacturing Company. All rights reserved. Reproduction in whole or in part without the express written permission of SARGENT Manufacturing Company is prohibited. Patent pending and/or patent: www.assaabloydss.com/patents.

Certification/Compliance

ANSI/BHMA	Certified ANSI/BHMA A156.2 (2017) Series 4000 — Grade 1 Certified ANSI/BHMA A156.41
UL/cUL	UL/cUL listed to US and Canadian safety standards for 3 hour doors up to 4' x 10' (double doors require 41- option)
NFPA 80	Conforms for life safety and property protection, Standard for Fire Doors and Other Opening Protectives
Positive Pressure	Meets ANSI/UL 10C, Positive Pressure Fire Test of Door Assemblies
ADA	All levers conform to ADA clear opening width requirements of ANSI A117.1
California State Reference Code (Formerly Title 19, California State Fire Marshal Standard)	All levers with returns comply; levers return to within 1/2" (13mm) of door face
Windstorm/Hurricane	All individual components of a total door opening are required to comply with each code.

Any retrofit or other field modification to a fire rated opening can potentially impact the fire rating of the opening, and Sargent Manufacturing Company makes no representations or warranties concerning what such impact may be in any specific situation. When retrofitting any portion of an existing fire rated opening, or specifying and installing a new fire-rated opening, please consult with a code specialist or local code official (Authority Having Jurisdiction) to ensure compliance with all applicable codes and ratings.

Windstorm Certifications: Florida Building Codes & UL Listings

SARGENT Manufacturing's products meet building codes that require hurricane and windstorm certifications, including some of the most stringent building codes as specified in the Florida Building Code, Miami Dade Code and the International Building Code. Listed below are certifications and standards met by the 11 Line lock.

Florida Building Code: FL2998

UL Certification Directory: ZHEM.R21744 – Latching Hardware

ANSI/SDI A250.13 (2014)	"Testing and Rating of Severe Windstorm Resistant Components for Swinging Door Assemblies"
ASTM E330 (2002)	"Standard Test Method for Structural Performance of Exterior Windows, Doors, Skylights and Curtain Walls by Uniform Static Air Pressure Difference"*
ASTM E1886 (2005)	"Standard Test Method for Performance of Exterior Windows, Curtain Walls, Doors, and Impact Protective Systems Impacted by Missile(s) and Exposed to Cyclic Pressure Differentials"*
ASTM E1996 (2009)	"Standard Specification for Performance of Exterior Windows, Curtain Walls, Doors and Impact Protective Systems Impacted by Windborne Debris in Hurricanes"*
(TAS) 201 (1994)	"Impact Test Procedures"*
(TAS) 202 (1994)	"Standard Test Method for Structural Performance of Exterior Windows, Doors, Skylights and Curtain Walls by Uniform Static Air Pressure Difference"*
(TAS) 203 (1994)	"Criteria for Testing Products Subject to Cyclic Wind Pressure Loading"*

* Published in the 7th Edition (2020), "Florida Building Code" (FBC), State Product Approval Number FL2998

UL Certification Directory: ZHLL.R21744 – Products for Use in Windstorm-rated Assemblies

Certifications to meet assembly requirements are done in conjunction with doors from ASSA ABLOY Group companies CECO DOOR and CURRIES.

ASTM E330 (2002)	"Standard Test Method for Structural Performance of Exterior Windows, Doors, Skylights and Curtain Walls by Uniform Static Air Pressure Difference"
ASTM E1886 (2005)	"Standard Test Method for Performance of Exterior Windows, Curtain Walls, Doors, and Impact Protective Systems Impacted by Missile(s) and Exposed to Cyclic Pressure Differentials"
ASTM E1996 (2009)	"Standard Specification for Performance of Exterior Windows, Curtain Walls, Doors and Impact Protective Systems Impacted by Windborne Debris in Hurricanes"

11 Line Bored Lock

Door Prep	ANSI/BHMA A156.115 (161)
Door Thickness	1-3/4" to 2" (44mm to 51mm) thick doors standard Specify 31- option for doors 2-1/4" to 2-1/2" (57mm x 64mm) centered in door prep, no paneling. Consult factory for other door thicknesses available by special application. Not available for 1-3/8" (35mm) thick doors
Backsets	2-3/4" (70mm) standard 3-3/4" (95mm) backset (specify 23- Option) 5" (127mm) backset (specify 25- Option)
Bearing Assembly	Cast and machined stainless steel
Front	Wrought brass, bronze or stainless steel 2-1/4" x 1-1/8" (57mm x 29mm) Self-adjusting for flat to 1/8" (3mm) in 2" (51mm) bevel
Strike	Wrought brass, bronze or stainless steel 800 curved lip strike standard 808 ANSI curved lip strike (specify 28- Option) Wrought box strike (specify WBS- Option)
Hand	Non-handed
Levers	Secured with 6 lobe security set screw standard 6 Lobe tool packed with each lock
Roses	Heavy wrought brass, bronze or stainless steel
Latchbolt	Stainless steel bolt 7/8" (22mm) dia. x 1/2" (13mm) throw Optional: Brass 3/4" (19mm) throw deadlocking fire latch for pair of doors (specify 41- Option)
Cylinder	Brass, 6-pin LA keyway, 1-bitted standard, specify KD for keyed different/random
Keys	Two nickel silver change keys per lock standard
Masterkeying	Can be masterkeyed or grand masterkeyed Construction key systems available
Finishes	03, 04, 09, 10, 10B, 10BE, 10BL, 14, 15, 20D, 26, 26D, BSP, WSP
Minimum Stile	4-1/4" (108mm) with B and O roses 4-1/2" (114mm) with E and L roses
Warranty	Ten-year limited

Strength & Durability

- True interlocking between the cast/ machined stainless steel lockbody and latchbolt provides strength and durability
- Independent Testing proves:
 - Exceeds ANSI/ BHMA A156.2 Grade 1 standard for cycle testing. Verified by UL for Operational Cycling ([V584148](#)) at 7 Million Cycles.
 - Exceeds ANSI/ BHMA A156.2 Grade 1 torque force on a locked lever. Over 3000 in/lbs!
 - Virtually no lever sag ever

Convenience

- Two-piece rose assembly goes quickly into place
- "Out of the box and onto the door" packaging organizes the parts, has simple instructions and even a small tool kit
- Fits any 161 prep; Does not fit 160 door prep
- Two piece rose & collar for easier installation
- Only 45° of lever rotation required to retract latchbolt
- 18 functions. Many functions are easily field changeable
- 4 ADA lever designs and 4 roses available to cover a wide variety of door preps and design requirements
- Simple cylinder removal. Easy change outs
- 14 Architectural grade finishes
- SARGENT uses engineered solutions and flexible manufacturing processes to accommodate special applications

Security

- The only bored lock on the market available with security lever catch feature for high vandalism application
- Resists vandalism
- Torx® and spanner screws
- Classroom security function available
- Security key systems available (Degree®, Signature, Keso F1, XC)

STC55 Acoustic Door System

11 Line Bored Lock

SARGENT
ASSA ABLOY

STC55 Acoustical Door Systems from Security Metal Products

SARGENT 11 Line bored locks are part of the STC Acoustical Door Systems from ASSA ABLOY Group brand Security Metal Products (SMP). The STC55 Acoustical Door Systems are the perfect choice for any room where sound transmission needs to be kept to a minimum. This solution encompasses door, frame, sound seals and threshold and lock. All door systems use standard locks. The STC55 requires a special version of the 11 Line lock.

To order the 11 Line bored lock for use with the STC55 door system, include the STC55 option in the 11 Line order string and specify the B or O rose only. With this option, it will be configured for a 1-3/4" door with a 3/4" panel for 2-1/2" total thickness. Door handing is required to dictate panel location.

To learn more about SMP and the STC Acoustical Door Systems, please visit www.secmet.com and search "sound / acoustical" products.

Applications

- Theatres and auditoriums
- Sound stages and production areas
- Recording studios
- Music classrooms
- Conference rooms
- Convention halls
- Offices and more

Lever & Rose Designs

11 Line Bored Lock

Lever & Rose Designs

Any rose and lever on this page can be combined to suit individual taste

OL Design

- Rose: O - Wrought
- Lever: L - Cast

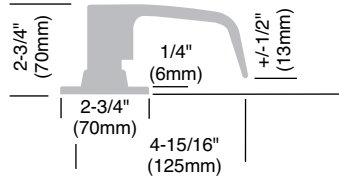

LJ Design

- Rose: L - Wrought
- Lever: J - Cast

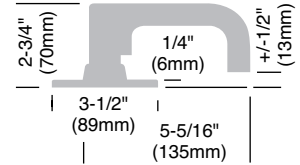

EB Design

- Rose: E - Wrought
- Lever: B - Cast

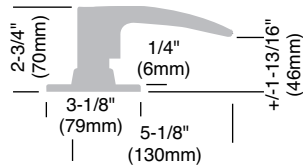

BP Design

- Rose: B - Wrought
- Lever: P - Cast

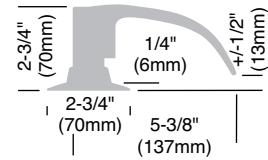

Note: Lever projections shown are for 1-3/4" (44mm) doors and will vary by door thickness

Single Cylinder Functions

04 Storeroom or Closet

11G04

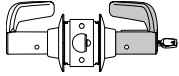

- Deadlocking latch
- Latchbolt by lever inside or key outside
- Outside lever rigid at all times
- **ANSI F86**

05 Entrance or Office

11G05

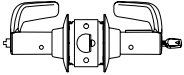

- Deadlocking latch
- Latchbolt by either lever unless outside lever is locked by turn button in inside lever
- Turn button must be released manually
- Key only retracts latchbolt when outside lever is locked
- **ANSI F81**

24 Entrance or Office

11G24

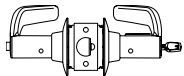

- Deadlocking latch
- Latchbolt by either lever unless outside lever is locked by push button in inside lever
- Push button released by key or turning inside lever
- Closing door does not unlock outside lever or release button
- **ANSI F82**

37 Classroom

11G37

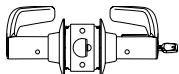

- Deadlocking latch
- Latchbolt by either lever unless outside lever is locked by key
- Key in outside lever locks or unlocks outside lever
- Inside lever always operative
- **ANSI F84**

44 Service Station

11G44

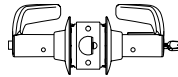

- Deadlocking latch
- Latchbolt by either lever unless outside lever is locked by push button of inside lever
- Key retracts latchbolt when outside lever is locked
- Push button will not depress unless door is in closed position
- Push button released by turning inside lever or by key in outside lever unless push button is fixed in locked position by turning coin slot in inside lever
- **ANSI F92**

50 Hotel, Dormitory or Apartment

11G50

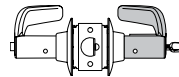

- Deadlocking latch
- Latchbolt by key outside and lever inside
- Outside lever always rigid
- Depressing push button when door is closed shuts out all keys except emergency key and projects visual occupancy indicator in cylinder face
- Push button will not depress unless door is closed in position
- Push button released by turning inside lever automatically reactivating all keys and retracting visual occupancy indicator
- Lock out key fixes push button in locked position, shutting out all keys except emergency (10-0042).
- Lock out key must be ordered separately
- See option page for restrictions to 50 function
- **ANSI F93**

54 Corridor

11G54

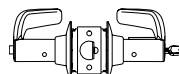

- Deadlocking latch
- Latchbolt by either lever unless outside lever is locked by push button inside or key outside
- Rotating inside lever releases button
- Push button will not depress unless door is in closed position
- Key outside locks or unlocks outside lever and releases inside button
- **ANSI F90**



Shaded lever indicates it is rigid at all times.

Double Cylinder Functions

16 Classroom, Security, Apartment, Exit, Privacy

11G16

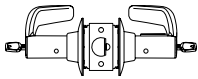

- Deadlocking latch
- Latchbolt by either lever unless outside lever is locked by key in inside lever
- Key in outside lever only retracts latchbolt when outside lever is locked
- **ANSI F88**

17 Utility, Asylum or Institutional

11G17

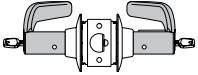

- Deadlocking latch
- Both levers rigid at all times
- Latchbolt by key either side
- Use only on rooms with more than one exit
- **ANSI F87**

30 Communicating

11G30

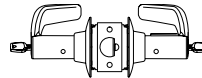

- Deadlocking latch
- Latchbolt by either lever
- Key in either lever locks or unlocks its own lever only
- Use only on rooms with more than one exit
- **ANSI F80**

38 Classroom Security Intruder

11G38

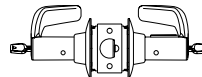

- Deadlocking latch
- Latchbolt by either lever unless outside lever is locked by key
- Key in either lever locks or unlocks outside lever
- When inside key locks the outside lever only the inside key can unlock the outside lever. The outside key only retracts the latchbolt until outside lever is unlocked by inside key
- Inside lever always operable
- Locking direction indicated on inside rose standard with this function. Available on rose designs E, L and O

Non-Cylinder Functions

13 Exit

11G13

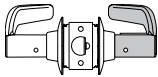

- Deadlocking latch
- Latchbolt by inside lever
- Outside lever rigid at all times
- **ANSI F89**

15 Passage

11U15

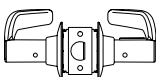

- Latchbolt by either lever
- **ANSI F75**

15-3 Exit or Communicating

11G15-3

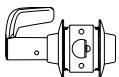

- Deadlocking latch
- Blank rose outside
- Latchbolt by lever inside
- Minimum clearance of 1-1/4" (32mm) required between doors

65 Privacy/Bathroom

11U65

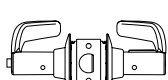

- Latchbolt by either lever unless outside lever is locked by push button in inside lever
- Turning inside lever or closing door releases button
- Emergency button in outside lever unlocks, with use of a blade screw driver in outside lever and releases inside button
- **ANSI F76A**

68 Hospital Privacy

11U68

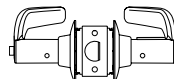

- Latch by either lever unless outside lever is locked by push button in inside lever
- Turning inside lever or closing door releases button
- Rotating thumbturn in outside lever unlocks the outside lever and releases the inside button
- Not available in the "J" lever design

93 Single Lever Pull

11U93

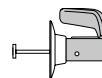

- For wood or custom hollow metal doors
- Lever and rose attached by through-bolt and four surface applied screws (hidden)
- Requires 5/16" (8mm) diameter hole

94 Double Lever Pull

11U94

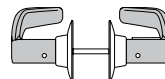

- For wood or custom hollow metal doors
- Lever and rose both sides joined by one through-bolt and four surface applied screws each side (hidden)
- Requires special door preparation – see template

94-2 Double Lever Pull

11U94-2

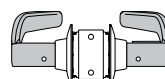

- For 161 and ANSI A115.2 prepared doors
- Lever and rose both sides joined by aligning tube and latchbolt tube
- Dummy latch plate



Shaded lever indicates it is rigid at all times.

Function Conversion Chart

11 Line Bored Lock



11 Line Function Conversion Chart

Function	Inside Lever	Inside Collar	Inside Sleeve	Latch	Bearing	Outside Sleeve	Outside Collar	Outside Lever
04: Storeroom/Closet	Passage lever	11-0031	11-2151	11-2106(B)	11-2899	11-2009	(On sleeve)	Cylinder lever
05: Entrance/Office	Pushbutton lever	11-0031	11-2152	11-2106(B)	11-2899	11-2009	(On sleeve)	Cylinder lever
13: Exit	Passage lever	11-0031	11-2151	11-2106(B)	11-2899	11-2010	(On sleeve)	Passage lever
15: Passage	Passage lever	11-0031	11-2153	11-2107(A)	11-2899	11-2153	11-0031	Passage lever
15-3: Exit or Communicating	Passage lever	11-0031	11-2153	11-2106(B)	11-2899	None - See Parts Book	None - See Parts Book	None - See Parts Book
16: Classroom Security/ Apartment	Cylinder lever	(On sleeve)	11-2011	11-2106(B)	11-2899	11-2009	(On sleeve)	Cylinder lever
17: Utility/Asylum	Cylinder lever	(On sleeve)	11-2013	11-2106(B)	11-2899	11-2012	(On sleeve)	Cylinder lever
24: Entry	Pushbutton lever	11-0031	11-2157	11-2108(K)	11-2899	11-2909	(On sleeve)	Cylinder lever
30: Communicating	Cylinder lever	(On sleeve)	11-2014	11-2106(B)	11-2899	11-2015	(On sleeve)	Cylinder lever
37: Classroom	Passage lever	11-0031	11-2153	11-2106(B)	11-2899	11-2014	(On sleeve)	Cylinder lever
38: Classroom Security	Cylinder lever	(On sleeve)	11-2011	11-2106(B)	11-2899	11-2017	(On sleeve)	Cylinder lever
44: Service Station	Pushbutton lever	11-0031	11-2154	11-2110(D)	11-2899	11-2009	(On sleeve)	Cylinder lever
50: Hotel/Motel	Pushbutton lever	11-0031	11-2155	11-2110(D)	11-2899	11-2016	(On sleeve)	Cylinder lever
54: Dormitory	Pushbutton lever	11-0031	11-2156	11-2110(D)	11-2899	11-2017	(On sleeve)	Cylinder lever
65: Privacy/Bathroom	Pushbutton lever	11-0031	11-2156	11-2111(C)	11-2899	11-2055	(On sleeve)	Cylinder lever

Note: Functions 93, 94 and 94-2 are of different construction. See Parts Manual for parts and construction

Copyright © 2007-2021, SARGENT Manufacturing Company. All rights reserved. Reproduction in whole or in part without the express written permission of SARGENT Manufacturing Company is prohibited. Patent pending and/or patent www.assaabloydss.com/patents.

Cylinders

11 Line Bored Lock

Cylinders

- Finishes: 04, 15, BSP

Type	Pins	Standard Cylinder	Hotel Cylinder	Interchangeable Core [^]	
				Large Format	Small Format
Conventional	6	C11-1	C11-2	6300	7300B
	7	N/A	N/A	N/A	7P-7300B
Signature	6	10-C11-1	N/A	10-6300	N/A
XC	6	11-C11-1	N/A	11-6300	N/A
	7	N/A	N/A	N/A	11-7P-7300B
Degree [®] DG1	6	DG1-C11-1	DG1-C11-2	DG1-6300	N/A
Degree [®] DG2	6	DG2-C11-1	N/A	DG2-6300	N/A
Degree [®] DG3	6	DG3-C11-1	N/A	DG3-6300	N/A

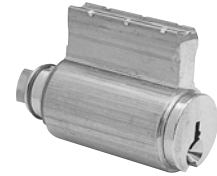

C11-1



6300



7P-7300B

All cylinders are supplied with 2 nickel silver change keys.

When cylinders are ordered keyed to 5 pin systems, the (6th) last chamber will be empty.

Cylinders are supplied 1 bitted unless specified keyed random or master keyed. For master keyed orders provide keying details as requested on SARGENT Keyed Order Lead Sheets, located in the price book or contact customer service.

To order cylinders separately, specify part number x keyway x finish (i.e. C11-1 x LA x 15)

[^] Locks will be provided with the applicable tailpiece per the type interchangeable and/or removable core being used.

Standard cores and Degree[®] cores require different tailpieces. When ordering complete locks, the appropriate option code must be specified in accordance to the permanent core being used. See pages 16-17 for cylinder options.

Cylinders with Competitive Keyways

Competitive Keyway	Part Number
Schlage [®] C	SC-C11-1
Schlage [®] E	SE-C11-1

All cylinders are 6-pin, 0-bit and supplied with two brass key blanks. Cylinders include tail piece.

Refer to Cylinders and Components catalog for more information.

Interchangeable Core Tailpieces (replacement parts)

Used with:	Type	P/N
6300 10-6300	LFIC Conventional LFIC Signature	11-0172
11-6300 DGX-6300	LFIC XC LFIC Degree [®]	11-5003
7300B	SFIC	11-0171
7P-7300B	SFIC 7 Pin	11-0172
11-7P-7300B	SFIC XC	11-0276

Note: Tailpieces included with lock.

Levers That Accept Cylinders/Cores from Other Manufacturers*

Cylinder Type	Option Code Ordered with Lock	Available Levers	Tailpiece P/N (provided with lock)	Competitor Cylinder Compatibility
Fixed Core				
Schlage [®] 6-pin	30-	All	11-2578	Schlage [®] Conventional or Primus [®]
Yale [®] 6-pin	YC-	L, P	11-5004 (spacer)	Yale [®] 1803-54L, 5803-54L and K403-54L cylinders only
Yale [®] 7-pin	YC-7P-	L, P		Yale [®] 1803A-54L, 5803A-54L and K403A-54L cylinders only
Interchangeable Core				
SFIC 6- or 7-pin	70-, 72-, 73-	All	11-0171 (6-pin)	All 6- or 7-pin small format interchangeable cores
			11-0172 (7-pin)	
Schlage [®] LFIC 6-pin	SF-	L	11-0403	All Schlage [®] 6-pin large format interchangeable cores
Yale [®] LFIC 6-pin	YRC-	L, P	11-5005 (tailpieces for both 6- and 7-pin included when ordered separately)	All Yale [®] 6-pin large format interchangeable cores
Yale [®] LFIC 7-pin	YRC-7P-	L, P		All Yale [®] 7-pin large format interchangeable cores

*Cylinder/core not included.

Experience a safer
and more open world

Latch Assemblies

- Finishes: 03, 04, 09, 10, 10B, 10BE, 10BL, 20D, 32D, BSP, WSP

Part	Code	Functions
Standard 2-3/4" (70 mm) Backset		
11-2106	B	04, 05, 13, 15-3, 16, 17, 30, 37, 38
11-2107	A	15
11-2108	K	24
11-2110	D	44, 50, 54
11-2111	C	65, 68
11-2112	—	94-2
23- option 3-3/4" (95mm) Backset		
11-2113	B	04, 05, 13, 15-3, 16, 17, 30, 37, 38
11-2114	A	15
11-2115	K	24
11-2117	D	44, 50, 54
11-2118	C	65, 68
11-2119	—	94-2

Part	Code	Functions
25- option 5" (127mm) Backset		
11-2120	B	04, 05, 13, 15-3, 16, 17, 30, 37, 38
11-2121	A	15
11-2122	K	24
11-2124	D	44, 50, 54
11-2125	C	65, 68
11-2126	—	94-2
41-option 3/4" (19mm) Throw		
08-2517	—	04, 05, 15, 15-3, 16, 37, 38

Note: Code letter stamped on inside corner of latch front identifies function(s) compatible with the latch assembly

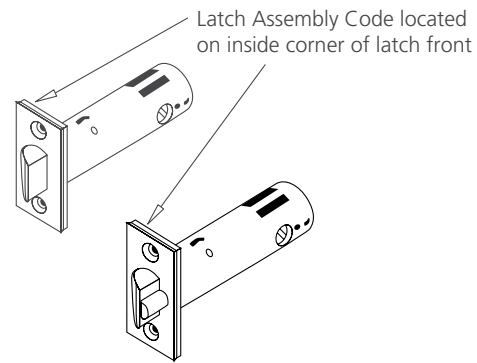

23- or 25- Option: Extended Backsets

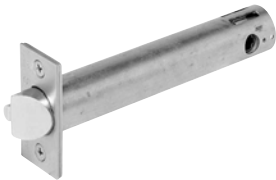

- 11 Line latches are available with extended backsets:
23- option 3-3/4" (95mm)
25- option 5" (127mm)
- To order with lock, specify 23- or 25- option and backset
Example: 23-11G05 x OL x 10B x 3-3/4" (95mm) backset
- To order latch separately, specify:
Part number x finish (see table above)

41- Option: 3/4" (19mm) Throw for Pairs of Doors



- For use on pairs of doors
- Guarded latchbolts listed by Underwriters Laboratories for use on 3-hour A Label pairs of doors
- Available functions: 11G04, 11G05, 11G15, 11G15-3, 11G16, 11G37 and 11G38
- To order with lock, specify 41- option
Example: 41-11G05 x OB x 10B
- 2-3/4" (70mm) Backset only
- Requires 78° of lever rotation to retract latchbolt
- Please note: special door prep required for 41- option — refer to template

Strikes

11 Line Bored Lock

- Finishes: 03, 04, 09, 10, 10B, 10BE, 10BL, 20D, 32, 32D, BSP, WSP

2-3/4" Curved Lip 800 T-Strike (Standard)

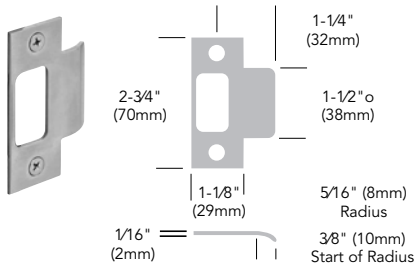

- Brass, bronze or stainless steel
- Furnished standard with 1-1/4" (32mm) curved lip, measured from center of strike screw holes to end of lip
- Lip lengths: 1-1/8" (29mm) to 2-7/8" (73mm) in 1/4" (6mm) increments only
- To order 800 strike with lock, specify lock and lip length
Example: 11G05 x LL x 10B x 1-3/4" (44mm) lip
- To order strike separately, specify 800 strike x finish x lip length
- Wrought box strike, 08-0055, provided standard

28- Option: 4-7/8" Curved Lip 808 ANSI Strike

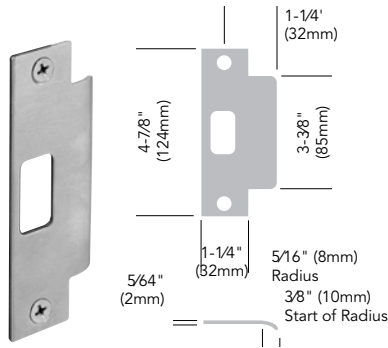

- Brass, bronze or stainless steel
- Conforms to ANSI standard 115.2
- Furnished standard with 1-1/4" (32mm) curved lip, measured from center of strike screw holes to end of lip
- Lip lengths: 1-1/8" (29mm), 1-1/4" (32mm) and 1-3/8" (35mm) to 2-7/8" (73mm) in 1/4" (6mm) increments only
- To order 808 strike with lock, specify 28- option with lock and lip length
Example: 28-11G05 x LL x 10B x 1-3/4" (44mm) lip
- To order strike separately, specify 808 strike x finish x lip length
- Wrought box strike not provided, order separately as 77-1141

ANSI Wrought Strike Box

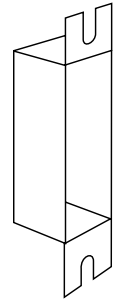

- Used with ANSI 4-7/8" (124mm) strike (#808)
- To order with lock, specify option WBS
- To order separately, specify 77-1141

11 Line Bored Lock

11-0138 Installation Wrench



14-0299 Lockout Key



- For hotel function only
- Order separately

01-4530 6 Lobe Security Tool (T-20)



- Two, 6 Lobe security lever set screws packed standard with each lock
- One T-20 tool packed per lock

6 Lobe and Spanner Bit Packs

82-3855	6 lobe bit pack 6 bits (Sizes – T8, T9, T10, T15, T20, T25, T27) Requires 9/32" driver
82-3856	Spanner bit pack 5 bits (Sizes – 6, 8, 10, 12, 14) Requires 1/4" driver

Type 161 Cutout

If weather-stripping, acoustical materials or silencers are used on the door or frame, care must be taken in the installation so that it will not interfere with the ease in which the latchbolt enters the strike

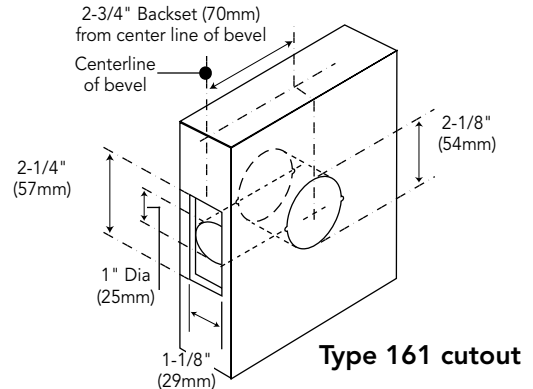

Copyright © 2007-2021, SARGENT Manufacturing Company. All rights reserved. Reproduction in whole or in part without the express written permission of SARGENT Manufacturing Company is prohibited. Patent pending and/or patent www.assaabloyds.com/patents.

Retrofit Option

11 Line Bored Lock

SARGENT 6010 Replacement Kit — for 7600 Integra Lock



Sub Front



800 Strike



808 Strike

- For installation of standard backset 11 Line lock replacing old 7600 Integra locks in wood doors
- Finishes: 03, 04, 10, 10B, 10BE, 10BL, 15, 20D, 26, 26D, BSP and WSP
- Replacement Kit consist of:

Quantity	Item	Item Number	Size
1	Sub Front	08-0562 x finish	4-1/4" x 1-1/4" (108mm x 32mm)
1	Strike (must specify 800 or 808)	800 x finish (with screws) 808 x finish (with screws)	2-3/4" x 1-1/4" x 1-1/4" (70mm x 32mm x 32mm) 4-7/8" x 1-1/8" x 1-1/4" (121mm x 29mm x 32mm)
1	Strike Box	08-0055 77-1141	For 800 Strike For 808 Strike (ANSI)
2	Sub Front Screws	01-5001	#10-24 x 3/4" (19mm)

Note: Strikes will not retrofit for strikes 4-1/4" x 1-1/8" x 1-1/4" (108mm x 29mm x 32mm). Lock will not retrofit for lock front plate size 5-1/4" x 1-1/4" (133mm x 32mm) – 36-7600 locks

Large Rose and Cover Plate



"L" Rose
3-1/2" (89mm) diameter
Order: 11-2446 x finish

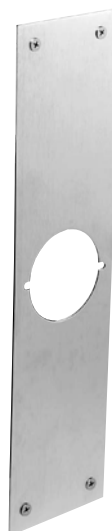

Cover Plate
3" x 12" (76mm x 305mm)
Order: 06-0037 x finish
(2 qty. required)

Screws
Order: 01-2037 x finish
(8 qty. required)

- To cover existing holes on face of door
- "L" roses can be ordered with the 11 Line lock
Example: 11G05 x LB x 26D
- Cover plate, if required, must be ordered separately

Experience a safer
and more open world

Cylinder Options

11 Line Bored Lock



Cylinder Options:

Conventional Cylinder	-	SARGENT conventional cylinders supplied standard (nomenclature not required)
Degree Key System	DG1-	SARGENT Degree key system level 1 (bump resistant with patented keys)
	DG1-21-*	Degree level 1 construction master keying
	DG1-60-	Degree level 1 removable disposable construction core
	DG1-63-	Degree level 1 removable core
	DG1-64-	Degree level 1 removable construction keyed LFIC
	DG1-65-*	Degree level 1 unassembled/uncombined fixed core component cylinder (packed loose for field keying)
	DG1-63-65-	Degree level 1 unassembled/uncombined removable core LFIC (packed loose for field keying)
	DG2-*	SARGENT degree key system level 2 (geographically exclusive; bump and pick resistant)
	DG2-21-*	Degree level 2 construction master keying
	DG2-60-*	Degree level 2 removable disposable construction core
	DG2-63-*	Degree level 2 removable core
	DG2-64-*	Degree level 2 removable construction keyed LFIC
	DG2-65-*	Degree level 2 unassembled/uncombined fixed core component cylinder (packed loose for field keying)
	DG2-63-65-*	Degree level 2 unassembled/uncombined removable core LFIC (packed loose for field keying)
	DG3-*	SARGENT Degree key system level 3 (geographically exclusive; UL437 certified; bump and pick resistant)
	DG3-21-*	Degree level 3 construction master keying
DG3-60-*	Degree level 3 removable disposable construction core	
DG3-63-*	Degree level 3 removable core	
DG3-64-*	Degree level 3 removable construction keyed LFIC	
Signature Key System	10-*	SARGENT Signature key system
	10-21-*	SARGENT Signature construction key system (lost ball)
Signature Removable Core	10-63-*	SARGENT Signature removable core cylinder
XC- Key System	11-*	XC key system (not available with other key systems, unless specified)
	11-21-*	XC - construction key system (lost ball)
XC- Large Format Interchangeable Core (Removable Core)	11-60-*	Lock to accept XC-LFIC (removable core) and provided with disposable plastic core; XC-LFIC permanent core ordered separately
	11-63-*	Lock provided with XC-LFIC (removable core); Includes master keying, grand master keying
	11-64-*	Lock to accept XC-LFIC (removable core) and provided with keyed construction core; XC-LFIC permanent core ordered separately.
XC- Small Format Interchangeable Cores	11-70-7P-*	Lock to accept XC-SFIC (7-pin, removable core) and provided with disposable plastic core; XC-SFIC permanent core ordered separately
	11-72-7P-*	Lock to accept XC-SFIC (7-pin, removable core) and provided with keyed construction core; XC-SFIC permanent core ordered separately
	11-73-7P-*	Lock provided with XC-SFIC (7-pin, removable core); Includes master keying, grand master keying
	11-65-73-7P-*	Lock provided with uncombined SFIC (7-pin, removable core); Packed loose
Construction Key Systems	21-*	SARGENT lost ball construction keying for conventional, XC and Signature Series (n/a with 63- or 73-)
	22-*	SARGENT construction split key system for conventional cylinders (existing systems only) (n/a with 10-, 11-, 63- or 73-)
Large Format Interchangeable Core (Removable Core)	60-*	Lock to accept LFIC (removable core) and provided with disposable plastic core; LFIC permanent core ordered separately
	63-*	Lock provided with LFIC (removable core); Includes master keying, grand master keying
	64-*	Lock to accept LFIC (removable core) and provided with keyed construction core; LFIC permanent core ordered separately

Note: Cylinder Options continued on the following page

* Options not available with 11G50

Copyright © 2007-2021, SARGENT Manufacturing Company. All rights reserved. Reproduction in whole or in part without the express written permission of SARGENT Manufacturing Company is prohibited. Patent pending and/or patent www.assaabloydss.com/patents.

90640 12/21

Cylinder Options

11 Line Bored Lock

Cylinder Options:

Small Format Interchangeable Cores	70-*	Lock to accept SFIC (6 or 7-pin, removable core) and provided with disposable plastic core; SFIC permanent core ordered separately
	72-*	Lock to accept SFIC (6 or 7-pin, removable core) and provided with keyed construction core; SFIC permanent core ordered separately
	73-*	Lock provided with SFIC (6-pin, removable core); Includes master keying, grand master keying
	73-7P-*	Lock provided with SFIC (7-pin, removable core); Includes master keying, grand master keying
	65-73-*	Lock provided with uncombined SFIC (6-pin, removable core); Packed loose
	65-73-7P-*	Lock provided with uncombined SFIC (7-pin, removable core); Packed loose
Keso & Keso F1	80-*	Lock to accept Keso and Keso F1 cylinders - no cylinders provided
	82-*	Lock provided with SARGENT Keso security cylinder
	F1-82-*	Lock provided with SARGENT Keso F1 security cylinder (patented)
Bump Resistant	BR-	Bump resistant cylinder (available with conventional & conventional XC cylinders only)
Keyed Different	KD-	Cylinders provided keyed differently/random
Less Cylinder	LC-	Lock supplied less cylinder
Schlage® Keyways	SC-*	Schlage® C keyway cylinder, 0 bitted
	SE-*	Schlage® E keyway cylinder, 0 bitted
Accepts Schlage® Cylinders	30-*	Lever to accept Schlage® fixed core cylinder - cylinder is not provided
	SF-*	L lever to accept Schlage® large format interchangeable core (supplied less core, tailpiece included)
ASSA V-10** (See note below)	VC-	Lock provided to accept ASSA v-10 interchangeable core cylinders. V-10 cylinders are available from ASSA, Inc @ 800-235-7482
Accepts Yale® Cylinders/Cores	YC-	L or P Lever to accept Yale® 6-pin fixed core cylinder - cylinder is not provided
	YC-7P-	L or P Lever to accept Yale® 7-pin fixed core cylinder - cylinder is not provided
	YRC-	L or P Lever to accept Yale® 6-pin large format interchangeable core (supplied less core, but with tailpiece needed)
	YRC-7P-	L or P Lever to accept Yale® 7-pin large format interchangeable core (supplied less core, but with tailpiece needed)

* Options not available with 11G50

** To use ASSA V-10 (VA & VS) cylinders with the 11 Line Lock, specify (LC-) less cylinder option and the lock will accept VA or VS cylinders. V-10 cylinders are available from ASSA, Inc. @ 800-235-7482

Note: 11 Line locks will be provided with the applicable tailpiece per the type interchangeable and/or removable core being used. For example standard cores and Degree® cores require different tailpieces. Appropriate option codes must be specified in accordance to the permanent core being used.

Mechanical Options

11 Line Bored Lock

Mechanical Options:

Backset Options	23-	3-3/4" backset x 2-1/4" x 1-1/8" front
	25-	5" backset x 2-1/4" x 1-1/8" front
Strike	28-	#808 strike; standard lip length 1-1/4". Other lip lengths must be specified; available lengths are 1-1/8", 1-3/8", 1-5/8", 1-7/8", 2-1/8", 2-3/8", 2-5/8" & 2-7/8"
Thick Doors	31-	For 2-1/4" to 2-1/2" thick doors, centered in door prep, no paneling. Consult factory for other door thicknesses available by special application.
Security Fasteners	36-	Six lobe security head screws
	37-	Spanner head screws
3/4" Throw	41-	3/4" (19mm) latch throw (04, 05, 15, 15-3, 16, 37 and 38 functions only) 78° lever rotation required
Lead Lined	74-	Lead provided between lockbody and spring cartridge
Tactile Warning Options	75-	Tactile warning – handicap warning milled on backside of inside lever
	76-	Tactile warning – handicap warning milled on backside of outside lever
	77-	Tactile warning – handicap warning milled on backside of both levers
	85-	Tactile warning – abrasive coating on inside lever
	86-	Tactile warning – abrasive coating on outside lever
	87-	Tactile warning – abrasive coating on both levers
Finish Protection	SG-	MicroShield® antimicrobial clear powder coat (Only available with 15 and 26D finishes)
	CPC-	Clear Powder Coat over 26D – 11G05 x OL x 26D x CPC
Additional Security	SL-	High security lever attachment (patent pending) available for keyed functions
Acoustical Door Systems	STC	STC 55 acoustical door system (see page 6)
Box Strike	WBS-	Wrought Box Strike

Copyright © 2007-2021, SARGENT Manufacturing Company. All rights reserved. Reproduction in whole or in part without the express written permission of SARGENT Manufacturing Company is prohibited. Patent pending and/or patent: www.assaabloydss.com/patents.

Finishes, Packaging

11 Line Bored Lock

Finishes

SARGENT #	Description	ANSI/BHMA
03	Polished brass, clear coated	605
04	Satin brass, clear coated	606
09	Polished bronze, clear coated	611
10	Satin bronze, clear coated	612
10B	Oxidized bronze, oil rubbed	613
10BE	Dark oxidized satin bronze - Equivalent	613E
10BL	Oxidized satin, bronze, clear coated	613L
14	Polished nickel, clear coated	618
15	Satin nickel, clear coated	619
20D	Statuary dark bronze, clear coated	624
26	Polished chrome	625
26D	Satin chrome	626
BSP	Black Suede Powder Coat	—
WSP	White Suede Powder Coat	—
SG- Option	MicroShield [®] available on 15 & 26D finishes only	
Zinc levers are plated to match ANSI/BHMA finish. Custom colors available, consult factory. Split finishes: - Specify outside finish first i.e. 11G05 x BB x 26D x 03 x RH - Handing must be specified - Strike and latch front will match the following: RH & LH = inside finish RHR & LHR = outside finish		

Lock Finish	Cylinder/Core*
03, 04, 09, 10, 10B, 10BE, 10BL, 20D	04
14, 15, 26, 26D, WSP	15
BSP	BSP

*Finish when cylinder provided with lock

Packaging

28-11G05 x OL
4 lbs. 8 oz./box (2.1 kg)
10 boxes/case

How to Order

11 Line Bored Lock

How to Order

5	11-28-	11G05	B	B	15	Door 3
Quantity	Options*	Lock & Function	Rose	Lever	Finish	Additional Information
	Available Options Pg 16-18 (Note: 28- for 808 ANSI Strike)	Available Functions Pg 8-9	Available Roses O, E, L & B Pg 7	Available Levers B, J, L & P Pg 7	Available Finishes Pg 19	Such as Item, Heading Number, Door Number, Keyset
<p>* Multiple Options may be selected Note: Lock must be centered within door; For locks not centered contact factory Note: 800 & 808 strikes have a standard 1-1/4 Lip length; all other lengths must be specified; available lengths are 1-1/8", 1-3/8", 1-5/8", 1-7/8", 2-1/8", 2-3/8", 2-5/8" & 2-7/8"</p>						

How to Specify Handing

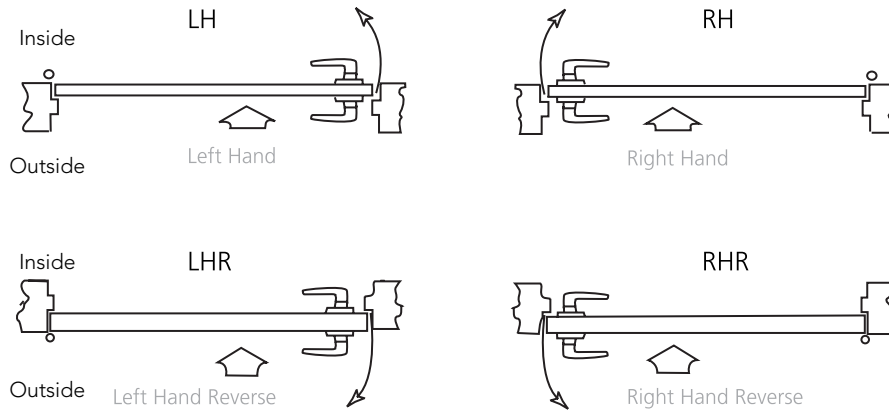

Copyright © 2007-2021, SARGENT Manufacturing Company. All rights reserved. Reproduction in whole or in part without the express written permission of SARGENT Manufacturing Company is prohibited. Patent pending and/or patent www.assaabloyds.com/patents.

Suggested Architectural Specifications

2.0 Bored Locksets – 11 Line

- A. All bored lever locks shall be manufactured by SARGENT Manufacturing Co., New Haven, CT.
- B. Locks shall be ANSI/BHMA Certified Products Directory (CPD) listed.
 - 1. A156.2, Series 4000, Grade 1
 - 2. A156.41
- C. Locksets shall be able to withstand 3000 inch pounds of torque applied to the locked lever without gaining access, while maintaining egress.
- D. Locksets shall exceed cycle test per ANSI/BHMA A156.2 Grade 1 requirements with no lever sag.
- E. Locks required for fire doors shall be listed by Underwriters Laboratories for ratings of A label (3 hours) and less, for doors up to 4'0" (1.2m) x 10'0" (3m) and pairs of doors 8'0" (2.4m) x 10'0" (3m) (with 41-option).
- F. Locksets shall be able to fit a standard 2-1/8" (55 mm) bore without the use of through-bolts. Standard rose size shall be 2-3/4" (70 mm) in diameter.
- G. Lockset levers shall be made of solid material with no plastic fillers.
- H. Latchbolt head shall be one piece stainless steel.
- I. Latchbolt assemblies shall be encased within the lockbody.
- J. Cylinders: SARGENT Degree® 6-pin cylinders with patented key control.
- K. Locks shall have 2-3/4" (70 mm) backset, standard.
- L. Strikes: Provide wrought boxes and strikes with proper lip length to protect trim but not to project more than 1/8" beyond trim, frame or inactive leaf. Where required, provide open back strike to allow practical and secure operation.
- M. Locksets shall have a ten year limited warranty.

The ASSA ABLOY Group is the global leader in access solutions. Every day, we help billions of people experience a more open world.

ASSA ABLOY Opening Solutions leads the development within door openings and products for access solutions in homes, businesses and institutions. Our offering includes doors, frames, door and window hardware, locks, perimeter fencing, access control and service.



SARGENT Manufacturing Company
100 Sargent Drive
New Haven, CT 06511 USA
800-727-5477
www.sargentlock.com

Founded in the early 1800s, SARGENT® is a market leader in locksets, cylinders, door closers, exit devices, electro-mechanical products and access control systems for new construction, renovation, and replacement applications. The company's customer base includes commercial construction, institutional, and industrial markets.

Copyright © 2007-2021, SARGENT Manufacturing Company. All rights reserved. Reproduction in whole or in part without the express written permission of SARGENT Manufacturing Company is prohibited. Patent pending and/or patent www.assaabloydss.com/patents.