

# 5300 Series Alarmed Exit Device

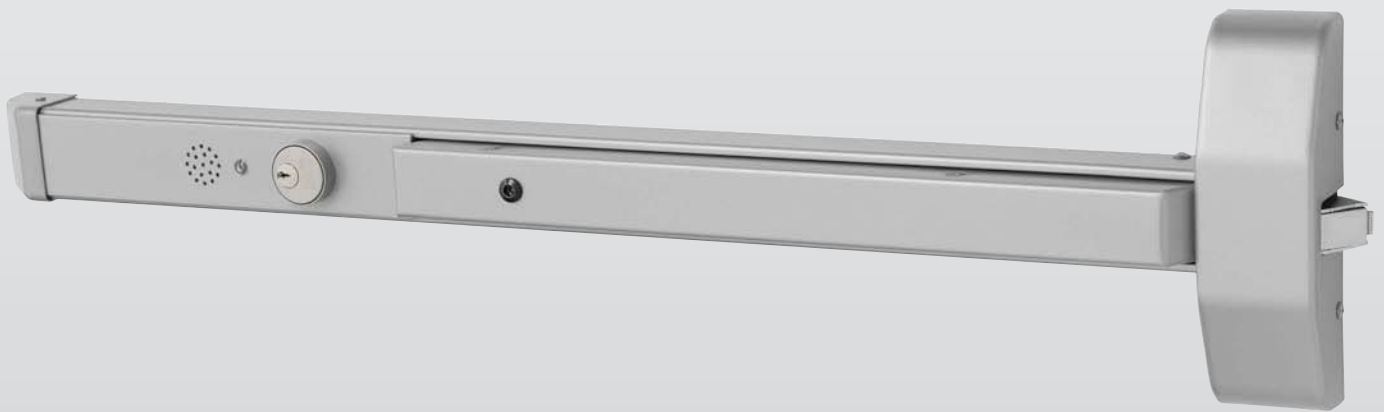

# Contents

## 5300 Series

Features . . . . .	3
Functions . . . . .	4
Architectural Specifications, Options, How To Order & Finishes . . . . .	5

Copyright © 2019, 2021, SARGENT Manufacturing Company. All rights reserved. Reproduction in whole or in part without the express written permission of SARGENT Manufacturing Company is prohibited. Patent pending and/or patent [www.assaabloydss.com/patents](http://www.assaabloydss.com/patents).

# Features

## 5300 Series

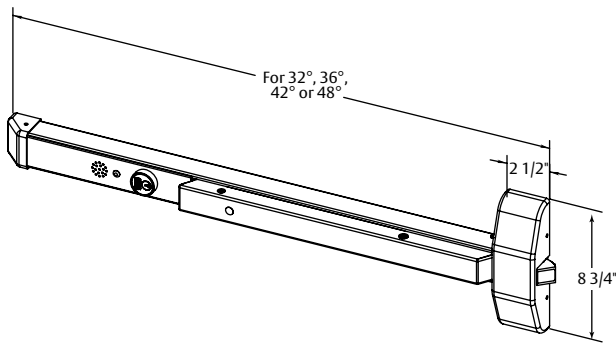

SARGENT's 5300 Series alarmed exit devices are designed for areas requiring a standalone alarm on outward swinging doors. An integrated alarm in the push rail discourages the unauthorized use of emergency exits doors, with the alarm sounding immediately upon exit. The 5300 Series is ideal for rear exterior doors, door leading to a rooftop, or anywhere security is a concern.

### Features

- Microprocessor based alarm board
- When armed, alarm sounds immediately upon rail depression
- All exit devices have tamper resistant latching (Guarded Latch)
- Battery powered – 9VDC
- 103 Db @ 8 ft pulsating horn
- Flashing red LED provides visible violation indication, reset by key only
- Low battery alert
- Automatic re-arming option
- Supplied with a #41 (1-1/8") with standard off set cam
- UL Listed and cUL Listed
- UL Listed to Canadian Safety Standards
- Rail Monitoring & Guarded Latch are standard internal features
- Minimum Door Widths:
  - E-32" only; F-36"-34"; J-42"-37";
  - G-48"-43"
- See McKINNEY's Transfer Device Solutions Catalog for QC Hinge and cable requirements (if hard wired)
- Complies to ANSI/BHMA A156.3 and A117.1
- Painted finishes: EN, EB, and ERD
- Plated finishes: BSP and 32D
- Touch bar assembly and cover (5300 & 12-5300) are rolled steel, and the chassis is nonferrous alloy
- 1-3/4" thick standard with a 4-1/2" minimum stile width. Furnished with wood and machine screws
- Through-bolts and mortise nuts are available to order
- The 5300 Series come standard with the dogging feature. The 12-5300 comes standard with the less dogging (LD) option











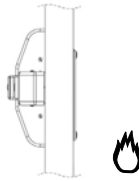
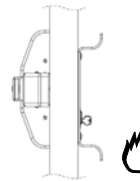
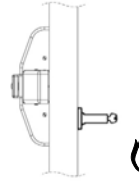
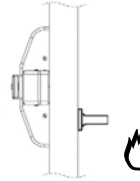



# Functions

## 5300 Series

**SARGENT**

**ASSA ABLOY**

Functions marked by  symbol are available as Fire Exit Hardware.

	<b>10</b> Exit only. No Outside operation.	<b>04</b> Key retracts latchbolt. Activating key will cause unit to enter 15 second delay mode.	<b>13</b> Key locks or unlocks lever. Activating lever will cause unit to enter 15 second delay mode.	<b>15</b> Similar to 13 with no outside cylinder, lever always operative. Rotating lever will sound alarm.
<b>Functions available for 5300 &amp; 12-5300</b>				
<b>Trims available for both 5300 &amp; 12-5300</b>	 88-DL   53 D GTB  53 E GTB	 88-KL   53 K HTB	 88-CL   53 K HTB	 88-LL   53 K HTB

To cover a 161 cutout (Pull) 53 D GTB, (Cover plate) 53 E GTB or (Pull with cylinder cutout) 53 K HTB may be used. This trim is furnished with 3 mortise nuts and screws for 1-3/4" doors.

To order specify trim x finish

**Example: 53 K HTB x EN**



53 K HTB



53 D GTB



53 E GTB

Copyright © 2019, 2021, SARGENT Manufacturing Company. All rights reserved. Reproduction in whole or in part without the express written permission of SARGENT Manufacturing Company is prohibited. Patent pending and/or patent www.assaabloydss.com/patents.

# Specifications, Architectural Options, How to Order & Finishes

## 5300 Series

### Suggested Architectural Specifications

1. All alarms to be 9 volt battery powered
2. Devices to be equipped with piercing audible alarm signal
3. Forcing latchbolt will sound alarm
4. All devices to possess solid state electronics
5. All devices to be non-handed or reversible
6. Removing cover will sound alarm

### How to Order 5300 Series Alarms (Trim sold separately)

36-Options	5300 Series	13 Function	EN
			Finish
Listed on this page	53	04	EN, EB, ERD, 32D, BSP
		10	
		13	
		15	

### How to order Trim for 5300 Series Exit Devices (Alarm Sold Separately)

Example:

11-	88-C-LL		32D
Options	Available Trim & Function Designation		Available Finishes
Listed on this page	<b>Lever &amp; Rose Trim</b>		<b>Lever &amp; Rose Finishes</b>
	88-K-LL (04 Function)	88-C-LL (13 Function)	BSP
	88-D-LL (10 Function)	88-L-LL (15 Function)	
	<b>Trims &amp; Pulls</b>		<b>Finishes</b>
	53 K HTB (04 Function)		EN
	53 E GTB (10 Function) Exit Only		EB
53 D GTB (10 Function) Pull		ERD	

### HANDING CHART

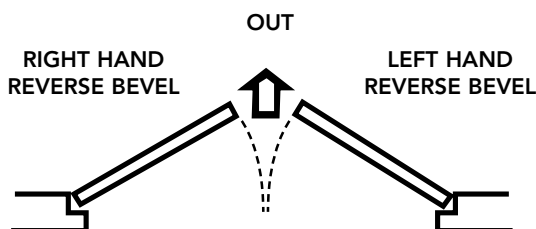

### Option Descriptions and Availability

10-	Signature System
11-	SARGENT XC Key System
12-	UL Fire Label Exit Devices
21-	Construction Keying Conventional, XC and Signature Series
22-	Construction Keying Conventional Cylinders (Existing Systems Only)
36-	6 Lobe security head screws
37-	Spanner head screws
82-	Keso Security Cylinder
94-	Automatic Re-Arm
BR-	Bump Resistant Cylinder (Available with Conventional & XC Cylinders Only)
SC-	Schlage C Keyway cylinder, 0-bitted
SE-	Schlage E Keyway cylinder, 0-bitted
TB-	Through Bolts
- All Alarmed Exit Hardware includes cylinders where applicable.	

### Option Descriptions

#### Automatic Rearming (94-Option)

The 5300 and 12-5300 equipped with spring loaded on/off switch.

- Switch returns to "on" position after removal of key
- Alarm always on
- Can be added in the field (Order part 32-7097)

### Finishes

Symbol	Description
EN	Polyester Powder coated to match US28
EB	Polyester Powder coated to match US10B
ERD	Polyester Powder coated - Red
32D	Dull Stainless Steel (Rail Assemblies)
BSP	Black Suede Powder Coat

The ASSA ABLOY Group is the global leader in access solutions. Every day, we help billions of people experience a more open world.

ASSA ABLOY Opening Solutions leads the development within door openings and products for access solutions in homes, businesses and institutions. Our offering includes doors, frames, door and window hardware, locks, perimeter fencing, access control and service.



SARGENT Manufacturing Company  
100 Sargent Drive  
New Haven, CT 06511 USA  
800-727-5477  
[www.sargentlock.com](http://www.sargentlock.com)

Founded in the early 1800s, SARGENT® is a market leader in locksets, cylinders, door closers, exit devices, electro-mechanical products and access control systems for new construction, renovation, and replacement applications. The company's customer base includes commercial construction, institutional, and industrial markets.

Copyright © 2019, 2021, SARGENT Manufacturing Company. All rights reserved. Reproduction in whole or in part without the express written permission of SARGENT Manufacturing Company is prohibited. Patent pending and/or patent [www.assaabloydss.com/patents](http://www.assaabloydss.com/patents).