

Experience a safer
and more open world



ELECTROMAGNETIC DOOR HOLDER/RELEASES

Designed for remote door
release applications

General Information

Electromagnetic door holder/releases are designed for virtually any remote door release applications. They must be used in conjunction with closing devices.

- Fire/smoke barrier doors
 - Door releases when tripped by an alarm or smoke detector
- Private offices
 - Door releases when triggered by a remote switch
- All devices come with a wall/floor portion and a door portion (armature)
- Circuit normally closed
- Door portions have screws and plates to accommodate surface and concealed mounting

Features

- 25 to 40 pounds holding force, except where noted
- Fail-safe operation; power failure releases door to close
- Positive release button initiates closing motion
- Tri-volt coils on most models see [2020](#)
- Spotting template included
- For stronger holding forces (50-55 lbs.) specify model and voltage. Not available in tri-volt coils

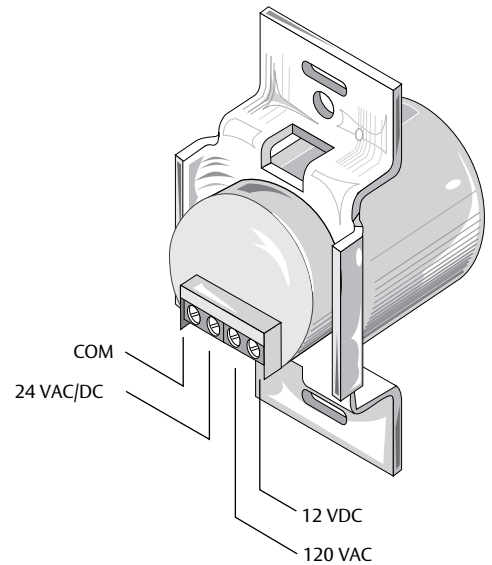

Certifications

- Compliant with ANSI/BHMA A156.15 Standards. See individual products for sub sections
- UL/ULC listed
- Listed by California State Fire Marshal

Specifications

All electromagnetic door holder/releases shall be supplied by architectural hardware supplier. All units shall have a single coil to accommodate 12VDC, 24VAC, 24VDC and 120VAC. The coils shall be independently wound, employing a fuse. Armatures will have positive release button.



ASSA ABLOY

Experience a safer
and more open world

HOW TO SELECT PRODUCT

Prior to determining the product you will need to use, begin by looking at the door and perpendicular wall relationship.

- Measure the distance. That will give you the "D" dimension. Select from chart A.

Chart A

If the distance from wall to door is: "D"	Use
7/16" (11)	989
1-13/16" (46)	990M
2-5/8" (67)	997M
3-5/8" (92)	998M
3-3/4" (95)	994M
4-1/8" (105)	996M
4-3/8" (111)	999M
5-1/8" (130)	998M x XK996M
6-5/8" (168) min. distance from wall	980M
6-3/4" distance between doors	981M

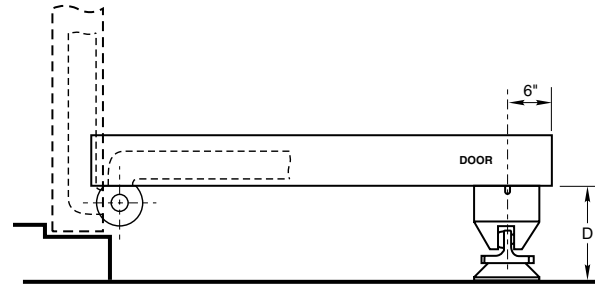

900 base has a minimum: 1-1/2" (38mm) extension. Maximum: 10" using combination of spacers [1/2" (13mm), 3/4" (19mm), etc.] Longer armature projections may encourage abuse and/or the weight of the extended rods will pull off the face of the door.

Chart B

Junction box location should always be as close as possible to the door pull/lever/knob.

A position horizontally farther toward the hinge edge will dramatically lessen the hold open force of the magnet.

A mounting too high on the vertical plane (top of door) will make it more difficult to pull out of hold open.

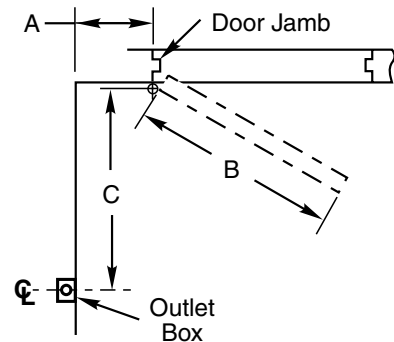

Refer to Diagram B

- How far is the centerline of the pivot/hinge from the wall? "A" dimension
- What is width of door? "B" dimension
- At what degree is the door opening? If this dimension is more than 100° consult template. The armature has a few degrees of adjustment but, before proceeding verify with the product template
- Dimension "C" is from pivot point to junction box centerline

**NORTON
RIXSON**

ASSA ABLOY

Experience a safer
and more open world

Model 997M

Application

- Wall mount
- Concealed wiring
- Shipping weight: 2 lbs. (0.9 kg)

Features

- Total projection: 2-5/8" (67mm)
- Mounting requirements: 2" x 4" x 1-3/4" (51 x 102 x 45mm) outlet box
- Wall must be properly reinforced and outlet box adequately fastened
- 2 year limited warranty

Compliance

- ANSI/C00011

Electrical Data

- Voltage and current:
 - 120VAC, 60Hz., .020 amp
 - 24VAC/DC, 60Hz., .020 amp
 - 12VDC, .040 amp
- For 50-55 lbs. of holding force, specify voltage
 - 120VAC, 60Hz .017 amp
 - 24VAC, 60Hz .080 amp
 - 24VDC, .068amp
 - 12VDC, .180amp

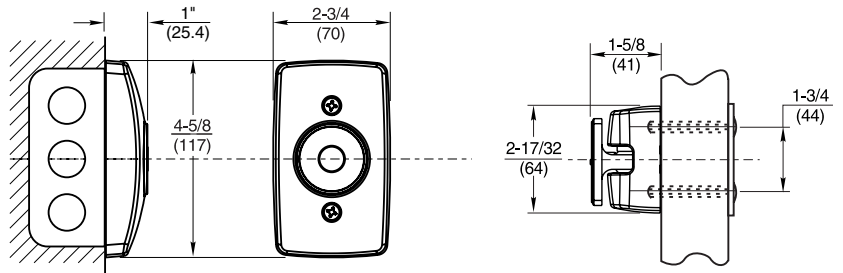
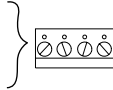

Model 998M

Application

- Wall mount
- Concealed wiring
- Shipping weight: 2-1/2 lbs. (1.1 kg)

Features

- Total projection: 3-5/8" (92mm)
- Mounting requirements: 2" x 4" x 1-3/4" (51 x 102 x 45mm) outlet box
- Wall must be properly reinforced and outlet box adequately fastened
- 2 year limited warranty

Compliance

- ANSI/C00011

Electrical Data

- Voltage and current:
 - 120VAC, 60Hz., .020 amp
 - 24VAC/DC, 60Hz., .020 amp
 - 12VDC, .040 amp
- For 50-55 lbs. of holding force, specify voltage
 - 120VAC, 60Hz .017 amp
 - 24VAC, 60Hz .080 amp
 - 24VDC, .068amp
 - 12VDC, .180amp

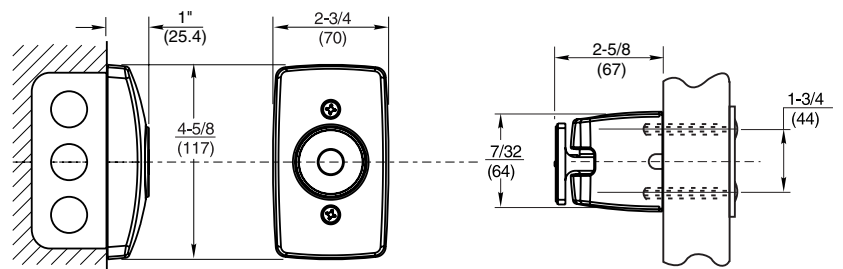
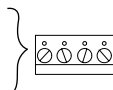

ASSA ABLOY

Experience a safer
and more open world