

Mini Mozart









FREESTANDING ELECTRIC SUITE

MMZ15E



Mini Mozart

Features

-  Unique Optiflame effect
-  1.5kW heat output
-  Choice of 2 heat settings
-  Thermostat
-  LED lighting
-  Remote control
-  Log effect fuel bed
-  Flame effect only
-  Suite - quick & easy to install

Mini Mozart



Remote Control



Fuel Bed

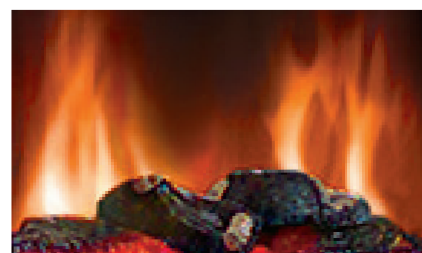

Logs

Mini Mozart

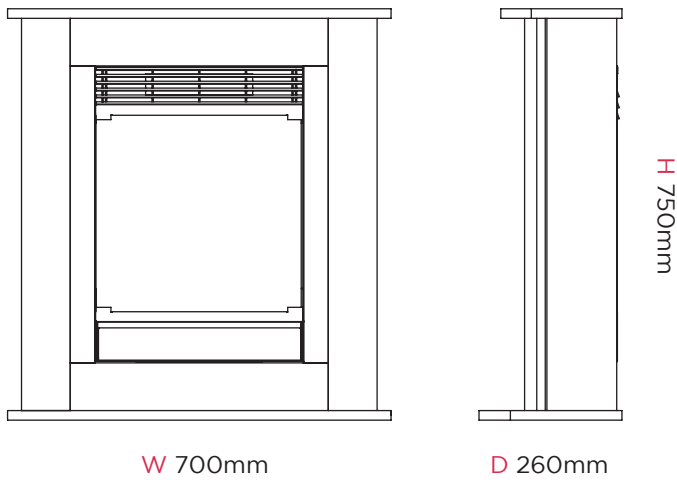

Dimensions & Weight			
Height (mm)	Width (mm)	Depth (mm)	Weight (kg)
750	700	260	20

Product Features	
Heat Output	1.5kW
Heat Settings	0.75kW / 1.5kW
Variable Thermostat	Y
Fan Heat / Radiant Heat	Yes / No
Location of Controls	On fire behind cover
On/Off Switch	Y
Remote Control	Y
Batteries Included	Y - 1 x CR2032
Optiflame Effect	Y
Flame Type	Optiflame
Flame Effect Only	Y
Fuel Bed Supplied	Log effect

Product Features	
Product Category	Electric Fires
Product Type	Suite
Brand	Dimplex
Model/Range Name	Mini Mozart
Flame Effect	Optiflame
Model Reference	MMZ15E
Material Code	500000135
Barcode	5011139061577
Commodity Code	8516299100
Country of Origin	PRC
Approvals	UKCA, BEAB
Guarantee Period	1 year

Product Features	
Lot 20 Compliant	Y
Freestanding	Y
Wall Mountable	N
Inset	N
Suite	Y
Assembly	Fully assembled
Lamp Type	LED
Kettle (IEC) Lead	N
Safety Cut Out	Y
Power Cord Length	1.8m
Core Materials	MDF / Plastic / Steel
Finish / Colour	Cream