

## Marbello









FREESTANDING ELECTRIC SUITE

MBL20



Marbello

### Features

-  Unique Optiflame effect
-  2kW heat output
-  Choice of 2 heat settings
-  Thermostat
-  LED lighting
-  Manual control
-  Pebble effect fuel bed
-  Flame effect only
-  Suite - quick & easy to install

### Marbello



### Remote Control



### Fuel Bed

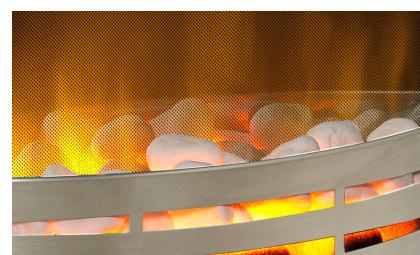

Pebbles

# Marbello

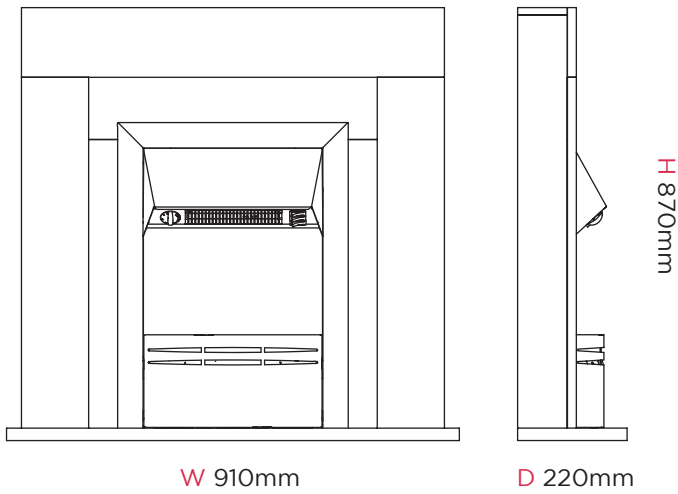

Dimensions & Weight			
Height (mm)	Width (mm)	Depth (mm)	Weight (kg)
870	910	220	20.7

Product Features	
Product Category	Electric Fires
Product Type	Suite
Brand	Dimplex
Model/Range Name	Marbello
Flame Effect	Optiflame
Model Reference	MBL20
Material Code	X-055354
Barcode	5011139055354
Commodity Code	8516299100
Country of Origin	PRC
Approvals	UKCA, BEAB
Guarantee Period	1 year

Product Features	
Heat Output	2kW
Heat Settings	2 - 1kW / 2kW
Variable Thermostat	Y
Fan Heat / Radiant Heat	Yes / No
Location of Controls	Beneath canopy
On/Off Switch	Y
Remote Control	N
Batteries Included	N
Optiflame Effect	Y
Flame Type	Rotisserie
Flame Effect Only	Y
Fuel Bed Supplied	Pebbles

Product Features	
Lot 20 Compliant	Y
Freestanding	Y
Wall Mountable	N
Inset	N
Suite	Y
Assembly	Fully assembled
Lamp Type	LED
Kettle (IEC) Lead	N
Safety Cut Out	Y
Power Cord Length	1.8m
Core Materials	MDF / Plastic / Steel
Finish / Colour	Travertine Marble Style/Black