



OPERATING INSTRUCTION MANUAL

Dimplex Opti-myst Electric Stove

Models: Willowbrook WLL20

These instructions should be read carefully and retained for future use. Note also the information presented on the appliance.

EN: This product is only suitable for well insulated rooms or occasional use. DE: Dieses Produkt ist nur für gut isolierte Bereiche oder gelegentliche Verwendung geeignet. FR: Ce produit convient uniquement à des endroits bien isolés ou pour un usage occasionnel. IT: Questo prodotto è adatto solo per spazi ben isolati o per uso occasionale. ES: Este producto sólo es adecuado para espacios bien aislados o un uso ocasional. NL: Dit product is uitsluitend geschikt voor goed geïsoleerde ruimten of voor sporadisch gebruik. PL: Produkt ten jest odpowiedni wyłącznie do dobrze odizolowanych miejsc lub do okazjonalnego użytku. NO: Dette produktet egner seg kun for godt isolerte rom eller sporadisk bruk. RO: Acest produs este adecvat exclusiv spațiilor bine ventilate sau utilizării ocazionale. CZ: Tento výrobek je vhodný pouze do dobře izolovaných prostor nebo k příležitostnému použití. DK: Dette produkt er kun egnet til velisolerede rum eller lejlighedsvis brug. PT: Este produto somente é adequado para espaços bem isolados ou uso ocasional. SE: Denna produkt är endast avsedd för välisolerade utrymmen eller tillfällig användning. FI: Tämä tuote soveltuu ainoastaan hyvin eristettyihin tiloihin tai satunnaiseen käyttöön. SK: Tento výrobok je vhodný len pre dobre izolované priestory alebo na občasné použitie. SI: Ta izdelek je primeren le za dobro izolirane prostore ali za občasno uporabo. HR: Ovaj proizvod je pogodan samo za dobro izolirane prostore ili povremenu upotrebu. HU: Ez a termék csak jól szigetelt terekhez vagy eseti használatra alkalmas.



The product complies with the required Product Safety, Electromagnetic Compatibility and Environmental Standards. This product is fully compliant with LVD, EMC, RoHS and EcoDesign Directives.

CAUTION: FAILURE TO FOLLOW THESE INSTRUCTIONS MAY CAUSE INJURY AND/OR DAMAGE AND MAY INVALIDATE YOUR GUARANTEE

Important Safety Advice

When using electrical appliances, basic precautions should always be followed to reduce the risk of fire, electrical shock and injury to persons, including the following:

- If the appliance is damaged, check with the supplier before installation and operation.
- Do not use outdoors.
- Do not use in the immediate surroundings of a bath, shower or swimming pool.
- Do not locate the appliance immediately below a fixed socket outlet or connection box.

Warning: This heater must not be used for anything other than normal domestic household purposes in the country where it was purchased from a recognised commercial retailer.

Do not use this heater if it has been dropped

Do not use if there are visible signs of damage to the heater.

Use this heater on a horizontal and stable surface, or fix it to the wall, as applicable.

Children of less than 3 years should be kept away unless continuously supervised. Children aged from 3 years and less than 8 years shall only switch on/off the appliance provided that it has been placed or installed in its intended normal operating position and they have been given supervision or instruction concerning use of the appliance in a safe way and understanding the hazards involved. Children aged from 3 years and less than 8 years shall not plug in, regulate and clean the appliance or perform user maintenance.

This appliance can be used by children aged from 8 years and above and persons with reduced physical, sensory or mental capabilities or lack of experience and knowledge if they have been given supervision or instruction concerning use of the appliance in a safe way and understand the hazards involved. Children shall not play with the appliance. Cleaning and user maintenance shall not be made by Children without supervision.

Warning: Do not use this heater in small rooms when they are occupied by persons not capable of leaving the room on their own, unless constant supervision is provided.

Warning: This appliance must be earthed.

The use of an extension lead or multi-plug adaptor is not advised when connecting this product to the mains. Connection through these devices could lead to a risk of overloading, overheating and even fire at the extension lead or adaptor due to inadequate connection quality.

This heater must be used on an ~alternating current supply (~) only and the voltage marked on the heater must correspond to the supply voltage.

Do not use this appliance in series with a thermal control, a program controller, a timer or any other device that switches on the heat automatically, since a fire risk exists when the appliance is accidentally covered or displaced.

DO NOT use the heater on deep pile carpets or the long hair type of rugs, or less than 750mm (30") away from any overhanging surface. Keep combustible materials such as drapes and other furnishings clear from the front, sides and rear of the heater. Do not use heater to dry your laundry. In the event of a fault unplug the appliance. Unplug the appliance when not required for long periods.

The appliance must be positioned so that the plug is accessible. If the supply cord is damaged it must be replaced by the manufacturer or service agent or a similarly qualified person in order to avoid a hazard. Keep the supply cord away from the front of the appliance.

Caution: Some parts of this product can become very hot and cause burns. Particular attention has to be given where children and vulnerable people are present. This instruction can be found at www.dimplex.co.uk

Warning: In order to avoid overheating, do not cover the appliance. Do not place material or garments on the appliance, or obstruct the air circulation around the appliance, for instance by curtains or furniture, as this could cause overheating and a fire risk.

The appliance carries a DO NOT COVER warning

Warning: To reduce the risk of fire, keep textiles, curtains, or any other flammable material a minimum distance of 1m from the air outlet.

Warning: In order to avoid a hazard due to inadvertent resetting of the thermal cut-out, this appliance must not be supplied through an external switching device, such as a timer, or connected to a circuit that is regularly switched on and off by the utility.

Dimplex Opti-myst Stoves

Model: Willowbrook

Thank you for choosing a Dimplex electric fire

General Information

The fire incorporates a flame effect, which can be used with or without heating, so that the comforting effect may be enjoyed at any time of the year.

A fan heater can provide heating in cold weather. A distance of 1 metre (3 feet) must be maintained between the front of the heater and any surrounding furniture, overhanging curtains or other obstructions.

Always ensure that the appliance is sitting on a level surface.

Before connecting the appliance, check that the supply voltage is the same as that stated on the appliance.

Only use filtered water in this appliance.

Once installed, never move this appliance or lay it on its back, without draining the water from sump and water tank. The water tank, sump, sump lid, tank cap and air filters must be cleaned once every 1 Week, particularly in hard water areas. If you intend not using the appliance for longer than 1 Week, drain the water from sump and water tank and dry the sump.

Please note: Used in an environment where background noise is very low, it may be possible to hear a sound which is related to the operation of the flame effect. This is normal and should not be a cause for concern.

The sump and the water tank in this product are treated with a biocidal product, Silver Biocide in order to control harmful or unwanted organisms. This conforms with the latest relevant ISO standard Do not drink the water from the sump or from the water tank(s)

Technical Information

Model No: WLL20

Heat Output		230V	240V	
Nominal Heat Output	P_{Nom}	1.6	1.8	kW
Minimum Heat Output	P_{min}	0.8	0.9	kW
Maximum Continuous Heat Output	P_{max}	1.6	1.8	kW
Auxiliary Electricity Consumption				
In Standby Mode	P_{Nom}	0.58	0.60	W

with electronic room temperature control.

Installation Instructions

This heater must be used on an AC ~ supply only and the voltage marked on the heater must correspond to the supply voltage. Before switching on, please read the safety warnings and operating instructions. Please retain this user's guide for future reference

Ensure that all packing items are removed (read any warning labels carefully).

Retain all packing for possible future use e.g. in the event of moving or returning the appliance to your supplier.

Installing the Appliance;

1. Clean the area where the fire will be installed e.g remove ash residue from an existing fireplace.
2. Hold the fire by the sides of surround and gently manoeuvre into position.
3. Plug the fire into a 13amp/240 volt outlet. Ensure that the supply cable is not trapped under the fire such that it might cause it to be damaged.

Connecting the Transducer

1. Open the stove door
2. Gently lift out the fuelbed and carefully set aside. (Fig 4)
3. Remove the water tank by lifting upwards and outwards. (Fig 5)
4. Remove the nozzle by unclipping and lifting upwards and outwards. (Fig 6)
5. The transducer will be inside the sump. Remove from its bag.
6. Place the Transducer unit into the sump and make the connection.
7. Locate the tab on the Transducer unit into the moulded recess in the base of the sump (Fig 7A)
8. Ensure that the cable does not obstruct the Transducer disc. To prevent the cable becoming pinched between the nozzle and the sump, place the cable in the slot in the wall of the sump. (Fig 7B)

Filling the Water Tank

1. Gently lift out the fuelbed and carefully set aside.
2. Remove the water tank by lifting upwards and outwards.
3. Place the water tank in sink and remove cap, Anti-clockwise to open. (Fig 8)
4. Fill tank with filtered tap water only. This is necessary to prolong the life of the flame and smoke producing unit. The water should be filtered through a conventional domestic water filter unit and the filter should be replaced regularly.
5. Screw the cap back on, do not over tighten.
6. Return the tank to the sump, with the tank cap facing down
7. Gently place the fuelbed back into position.



When the water tank is empty, the flame and smoke effect shuts off, you will hear 2 audible beeps and the digital display will display   !

Operating The Product



WARNING: FAILURE TO FOLLOW THESE OPERATING INSTRUCTIONS MAY RESULT IN INJURY AND/OR DAMAGE.



Manual Controls



The manual controls are located behind the stove door. Open the stove door to access the manual controls. (Fig 2)

 is the on/standby button. Press it once to turn on the product. Press it again to turn off the product. When turned on a 'beep' will sound and the digital display will show  followed by the current room temperature. The display will then turn off. The fuelbed will light up. Be careful not to look directly into the fuelbed as the LED lights are very bright. It will take a approximately 45 seconds before the flame effect starts.

 is the Mode button.

Press it once and you will be in the **HEAT** options. The display will show the current setting. Using the  and  buttons you can turn the heat on at the LOW or HIGH setting and turn the heat OFF. You will hear two 'beeps' for LOW heat setting, three 'beeps' for HIGH heat setting and one 'beep' when the heat is turned off.







Press it a second time and you will be in the temperature set mode . The display will show the current room temperature and then the set point temperature. Using the  and  buttons you can adjust the set point temperature up and down. Note: if the set point temperature is below the room temperature the heat function will not operate. The temperature range is from 15-35°C





Press it a third time and you will be in the Fire mode. The display will show **FIRE** followed by the current fire effect setting. There are six fire settings. Using the  and  buttons you can adjust the height of the flame effect.

Press M	Display	Function	Press + or -		
Once	HEAT	Controls the fan heater	Off	Low	High
Twice		Thermostat	From 15 °C	To 35 °C	
Three times	FIRE	Flame intensity	From F1 (low)	To F6 (high)	











Remote control

The remote control is supplied with a battery already in place. Simply pull on the clear plastic tab on the back of the remote control to enable the battery.

-  is the on/standby button. Press it once to turn on the product. Press it again to turn off the product. When turned on you will hear on 'beep' and the digital display will show  followed by displaying the current room temperature. The display will then turn off. The main LED lights will activate. Be careful not to look directly into the LED's. These are very bright. Although the main lights operate immediately it will take a further 45 seconds before the flame effect starts.
- Press  once to activate  heat setting. Press it again to activate  heat setting. If you continue to press this button you will cycle through the LOW and HIGH heat settings. You will hear two 'beeps' for LOW heat setting and three 'beeps' for HIGH heat setting.
- Press  once to turn off the heat. You will hear one 'beep'

- Press the  button to display the current room temperature followed by the current set point temperature
- Press the  and  buttons to adjust your set point temperature. Note: if the set point temperature is below the room temperature, the heat function will not operate. The temperature range is from 15 - 35°C
- Press  to increase the F1 F6 setting.
- Press  to decrease the F1 F6 setting.

Setting the Thermostat

Plug in the product and press  to turn it on. Press the  button twice and to enter the temperature set mode --. The current room temperature will be displayed (e.g. r23C) followed by the current set point room temperature (e.g. 26C). Press the  and  buttons to select your set point room temperature. Allow the display to turn off. Press the  button once to enter the Heat option. Press the  and  buttons to select either -- or -- heat output. The heater will turn on when your set point room temperature is higher than the room temperature.

Thermal Safety Cut-out

A thermal safety cut-out is incorporated in the fan heater to prevent damage due to overheating. This can happen if the heat outlet was restricted in any way. If the cut-out operates, unplug the heater from the socket outlet and allow approximately 10 minutes before reconnecting. Before switching the heater back on remove any obstruction that may be restricting the heat outlet, then continue normal operation.

CAUTION: In order to avoid a hazard due to inadvertent resetting of the thermal cutout, this appliance must not be supplied through an external switching device, such as a timer, or connected to a switch that is regularly switched on and off by the utility.

Getting the Desired Flame Effect

1. Using the manual controls or the remote control choose a F1 F6 setting between F1 and F6. F1 being the lowest setting and F6 being the highest setting.
2. Generally the flames appear more realistic when the flame control is turned down.
3. Give the flame generator time to react to changes you may make.
4. The fire will use less water if the flame effect is set to a lower level.
5. Do not tilt or move the fire while there is water in the tank or sump.
6. Make sure that the fire is on a level floor.

Maintenance

General Tips

Only use filtered tap water in this appliance.

Always ensure that the appliance is sitting on a level surface.

If you intend not using the appliance for longer than 1 Week, remove and empty the sump and water tank.

Once installed, never move this appliance or lay on its back, without draining the water from sump and water tank.

Cleaning

Warning – Always press  to turn off the product and disconnect the product from the power supply before cleaning the fire. Leave the appliance for 10 minutes to allow the product to cool down.

We recommend cleaning the following components once every 1 Week, particularly in hard water areas:

Water Tank, Sump, Nozzle, Tank cap and seal, Air filter.

For general cleaning use a soft clean duster – never use abrasive cleaners.

To remove any accumulation of dust or fluff, the soft brush attachment of a vacuum cleaner should occasionally be used to clean the outlet grille of the fan heater.

Water Tank

1. Remove water tank, as described earlier, put into sink and empty water.
2. Using the supplied brush gently rub the inside surfaces of the cap paying particular attention to the rubber ring in the the outer groove and the center rubber seal.
3. Put a small quantity of washing up liquid into the tank, refit the cap and shake well, rinse out until all traces of washing up liquid are gone.
4. Refill with filtered tap water only, replace the cap, do not over tighten.

Sump

Press  to put the product into standby

Gently lift out the fuelbed and place carefully on the ground.

Remove the water tank by lifting upwards.

Remove the sump lid, this allows the sump to be lifted completely from its location. (Fig 5)

Gently lift up the sump, taking care to keep level so as not to spill any water. Sit the assembly in the sink.

Carefully tilt so that the liquid drains out of the sump.



Put a small amount of washing up liquid into the sump, and using the supplied brush, gently clean all surfaces including the metal disc (Fig 9)

When cleaned, thoroughly rinse the sump with clean water.

Clean the outlet surface of the sump lid with the brush and flush out thoroughly with water.

Reverse the above steps to reassemble.

Air Filter

1. Press  on the remote control or on the product to turn it off
2. Gently lift off the fuelbed and set aside
3. Remove the tank and place in a sink with the cap facing upwards.
4. Gently slide up the air filter (Fig. 10)
5. Gently rinse with water in the sink and dry with fabric towel before returning.
6. Replace the filter making sure that the coarse black filter is in contact with the plastic holder.
7. Replace the tank.
8. Replace the fuelbed.
9. Press  to turn on the product

General Cleaning and Maintenance

The outside can be cleaned by wiping it over with a soft damp cloth and then dried. Do not use abrasive cleaning powders or furniture polish, as this can damage the surface finish.

CAUTION: Assembly, installation and repair of this heater must be carried out by Dimplex or its authorised agent.

CAUTION: We recommend that you arrange for this heater to be checked annually for safety by a qualified electrician.

Additional Information

After Sales Service

Your product is guaranteed for one year from the date of purchase. Within this period, we undertake to repair or exchange this product free of charge (excluding transducer discs & subject to availability) provided it has been installed and operated in accordance with these instructions. Your rights under this guarantee are additional to your statutory rights, which in turn are not affected by this guarantee.

The transducer is a consumable item and may need to be replaced through time, depending on its usage. Replacement transducers can be purchased from our website <http://spares.dimplex.co.uk>. The transducer has a 12 month warranty period.

CAUTION: Do not use if the heater's mains power lead is damaged. Such use may cause a hazard. If damaged, the mains power lead must be replaced by the manufacturer or its authorised dealer.

Should you require after sales information or assistance with this product please go to www.dimplex.co.uk and select "Customer Support" or ring our help desk on 0344 879 3588 (UK) or 01 842 4833 (R. O. I.). Spare parts are also available on the web site. Please retain your receipt as proof of purchase.

Recycling

At the end of the electrical products useful life it not be disposed of with household waste. Please  recycle where facilities exist. Check with your Local Authority or retailer for recycling advice in your country.

Patent / Patent Application

Products within the Optimyst range are protected by one or more of the following patents and patent applications:

Great Britain GB2460259B, GB2475794B, GB2418014, EP2029941, GB2436212, GB2402206B

United States US8413358, US8136276, US7967690, US8574086

Russia RU2434181

European EP2029941, EP2315976, EP1787063 (A1), EP2388527

China CN101883953A, CN102105746A, CN101057105 (A), CN101438104

Australia AU2009248743A1, AU2007224634

Canada CA2725214, CA2579444, CA2645939

South Africa ZA2008/08702

Mexico MX2008011712

South Korea KR101364191

Japan JP5281417, JP5496291

Brazil BRP10708894

India 4122/KOLNP/2008

New Zealand NZ571900

Fig. 1a

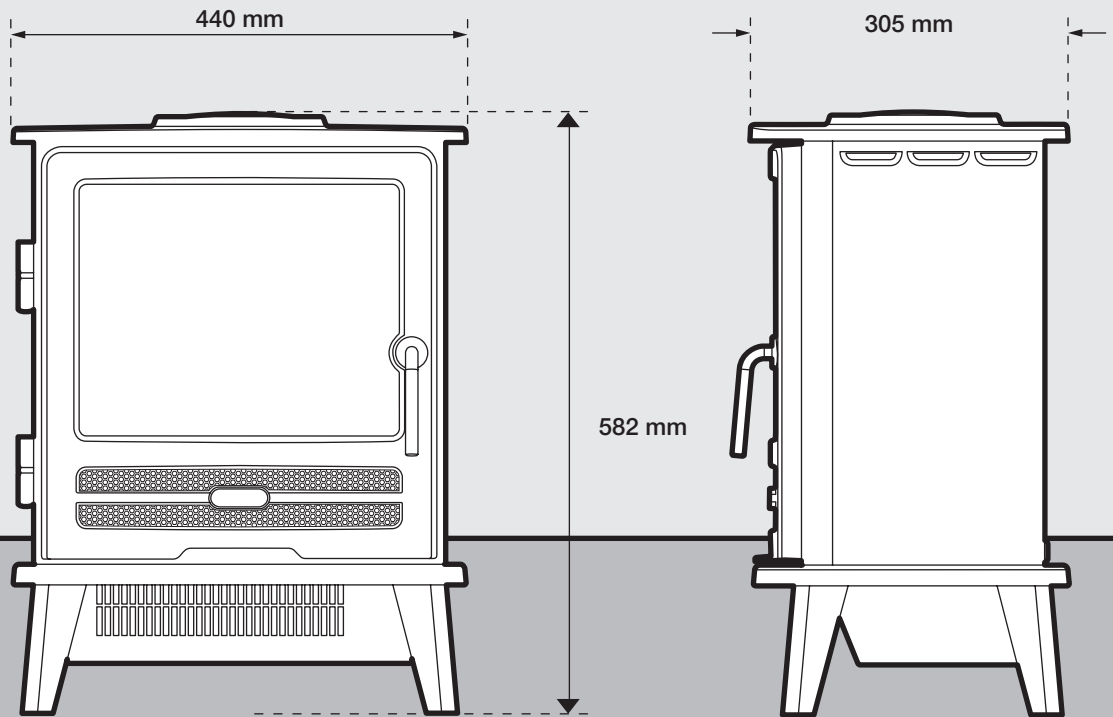

Fig. 2

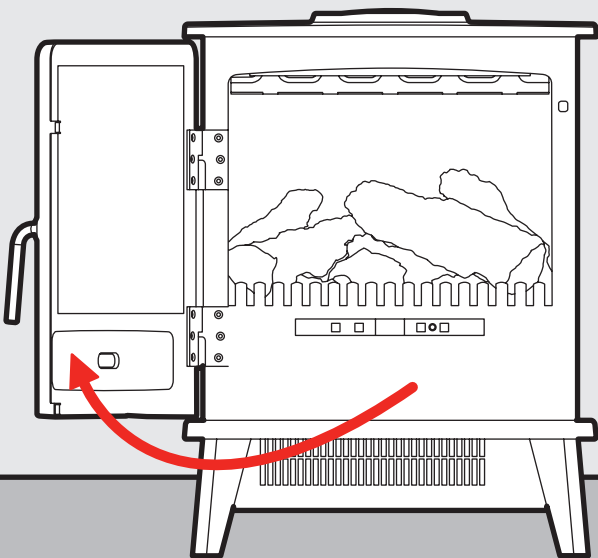

Fig. 1b

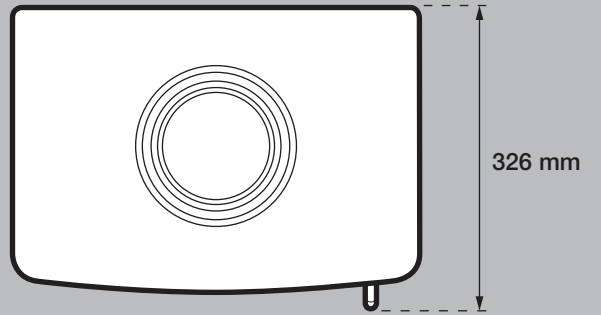

Fig. 3

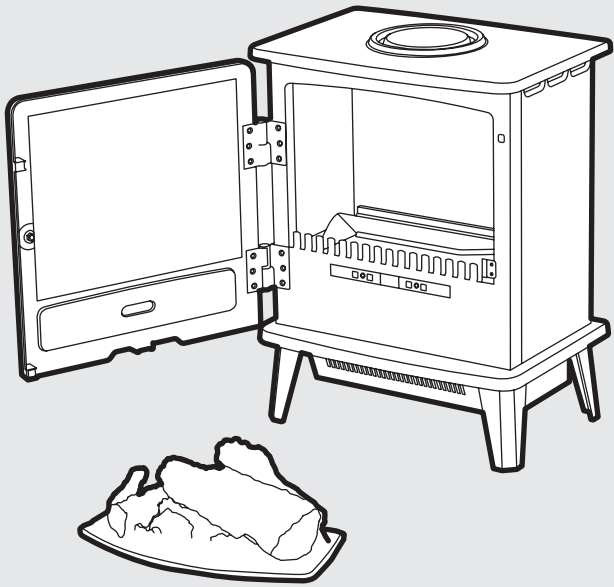

Fig. 4

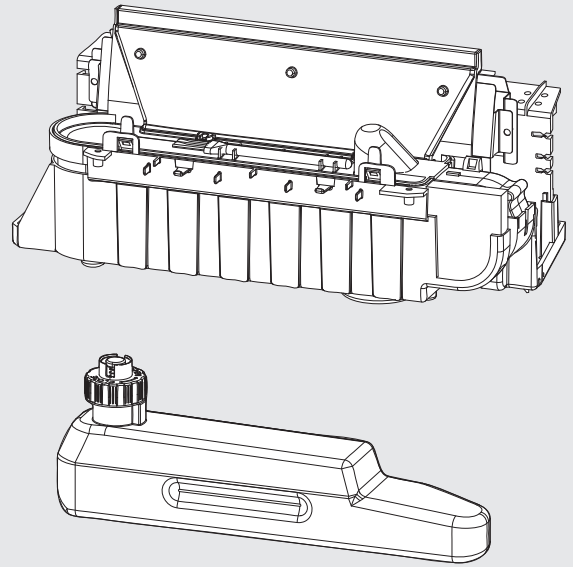

Fig. 5

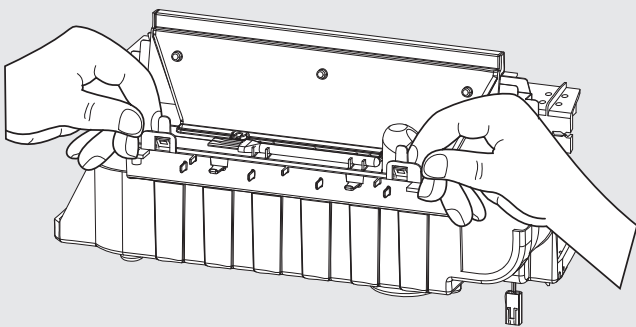

Fig. 6

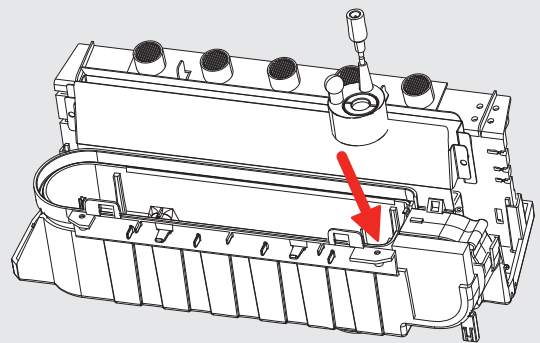

Fig. 7

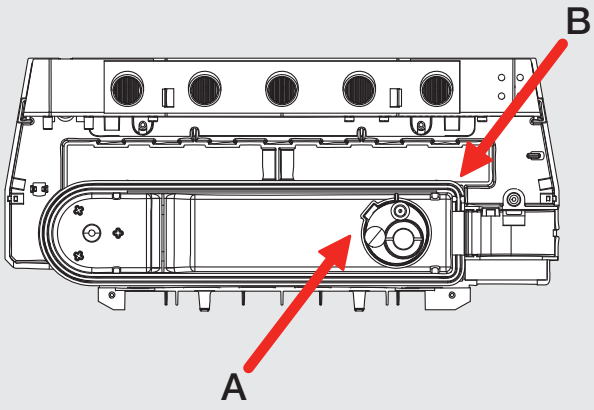

Fig. 8

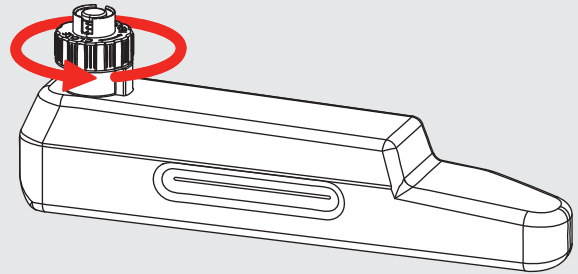

Fig. 9

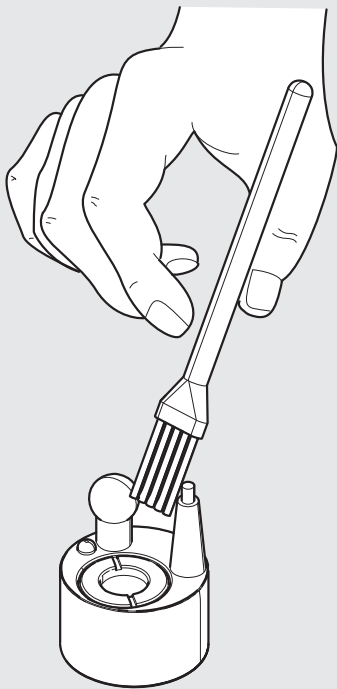
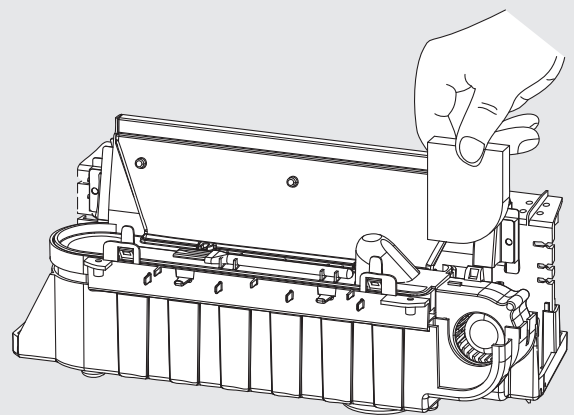

Fig. 10





Tel: 0344 879 3588

Republic of Ireland Tel: 01 8428 222

www.dimplex.co.uk

© Glen Dimplex Heating & Ventilation..

Millbrook House, Grange Drive, Hedge End, Southampton, SO30 2DF