

# **DS703 FC**

## Diagnostic Video Borescope

### Users Manual



March 2018 (English) Rev. 1, 9/22

© 2018-2022 Fluke Corporation. All rights reserved. Specifications are subject to change without notice.

All product names are trademarks of their respective companies.

## **LIMITED WARRANTY AND LIMITATION OF LIABILITY**

Each Fluke product is warranted to be free from defects in material and workmanship under normal use and service. The warranty period is two years and begins on the date of shipment. Parts, product repairs, and services are warranted for 90 days. This warranty extends only to the original buyer or end-user customer of a Fluke authorized reseller, and does not apply to fuses, disposable batteries, or to any product which, in Fluke's opinion, has been misused, altered, neglected, contaminated, or damaged by accident or abnormal conditions of operation or handling. Fluke warrants that software will operate substantially in accordance with its functional specifications for 90 days and that it has been properly recorded on non-defective media. Fluke does not warrant that software will be error free or operate without interruption.

Fluke authorized resellers shall extend this warranty on new and unused products to end-user customers only but have no authority to extend a greater or different warranty on behalf of Fluke. Warranty support is available only if product is purchased through a Fluke authorized sales outlet or Buyer has paid the applicable international price. Fluke reserves the right to invoice Buyer for importation costs of repair/replacement parts when product purchased in one country is submitted for repair in another country.

Fluke's warranty obligation is limited, at Fluke's option, to refund of the purchase price, free of charge repair, or replacement of a defective product which is returned to a Fluke authorized service center within the warranty period.

To obtain warranty service, contact your nearest Fluke authorized service center to obtain return authorization information, then send the product to that service center, with a description of the difficulty, postage and insurance prepaid (FOB Destination). Fluke assumes no risk for damage in transit. Following warranty repair, the product will be returned to Buyer, transportation prepaid (FOB Destination). If Fluke determines that failure was caused by neglect, misuse, contamination, alteration, accident, or abnormal condition of operation or handling, including overvoltage failures caused by use outside the product's specified rating, or normal wear and tear of mechanical components, Fluke will provide an estimate of repair costs and obtain authorization before commencing the work. Following repair, the product will be returned to the Buyer transportation prepaid and the Buyer will be billed for the repair and return transportation charges (FOB Shipping Point).

**THIS WARRANTY IS BUYER'S SOLE AND EXCLUSIVE REMEDY AND IS IN LIEU OF ALL OTHER WARRANTIES, EXPRESS OR IMPLIED, INCLUDING BUT NOT LIMITED TO ANY IMPLIED WARRANTY OF MERCHANTABILITY OR FITNESS FOR A PARTICULAR PURPOSE. FLUKE SHALL NOT BE LIABLE FOR ANY SPECIAL, INDIRECT, INCIDENTAL OR CONSEQUENTIAL DAMAGES OR LOSSES, INCLUDING LOSS OF DATA, ARISING FROM ANY CAUSE OR THEORY.**

Since some countries or states do not allow limitation of the term of an implied warranty, or exclusion or limitation of incidental or consequential damages, the limitations and exclusions of this warranty may not apply to every buyer. If any provision of this Warranty is held invalid or unenforceable by a court or other decision-maker of competent jurisdiction, such holding will not affect the validity or enforceability of any other provision.

Fluke Corporation  
P.O. Box 9090  
Everett, WA 98206-9090  
U.S.A.

Fluke Europe B.V.  
P.O. Box 1186  
5602 BD Eindhoven  
The Netherlands

## Documentation and Software Licensing Notice

For software licensing information, visit [www.fluke.com/licensing](http://www.fluke.com/licensing).

For products containing software licensed under the GNU General Public License (GPL) or Lesser GNU General Public License (LGPL)", the complete corresponding sources are available. You can order a complete machine-readable copy of the source code from Fluke Corporation for a period of three (3) years after receipt of the product.

Send a written request to:

Open Source Request

Fluke Corporation

6920 Seaway Blvd

Everett, WA 98203

Please include:

- Full name
- Company name
- Product model
- Return mailing address
- Email address (if available)

### *Note*

*Fluke Corporation may charge a fee to cover the cost of this distribution. This offer is valid to anyone in receipt of this information.*



# Table of Contents

Title	Page
Introduction .....	1
How to Contact Fluke.....	1
Safety Information.....	1
Specifications.....	1
Product Familiarization .....	2
Features.....	2
In the Box.....	3
Accessories.....	5
Display .....	6
Control Panel.....	7
Basic Operation .....	7
Capture an Image .....	7
Record a Video .....	8
Menus .....	8
Primary Menu .....	8
Image Menu.....	9
Setup Menu .....	9
Date .....	10
Time.....	10
Fluke Connect .....	11
Memory Menu.....	11
Review Image or Video .....	11
Delete Image .....	12
View Images or Videos .....	12
View on a PC.....	12
View on an HDMI Device.....	13
View with Fluke Connect .....	13
Update Firmware .....	13
Fluke Connect Desktop Software .....	13
Neck Strap .....	14
Maintenance .....	14
Clean the Product.....	15
Charge the Battery.....	15
Product Disposal.....	16
Radio Frequency Data .....	16



## Introduction

The Fluke DS703 FC Diagnostic Video Borescope (the Product) is a handheld, imaging camera for use in many applications. These applications include equipment troubleshooting, preventive and predictive maintenance, building diagnostics, and research and development.

The Product displays images on a high-visibility, industrial-quality LCD screen. The Product saves images and videos to internal memory or to memory on a USB storage device. Saved images and videos can be transferred to a PC through a direct USB connection to the PC. Saved images can be transferred to Fluke Connect® where available.

## How to Contact Fluke

Fluke Corporation operates worldwide. For local contact information, go to our website: [www.fluke.com](http://www.fluke.com)

To register your product, view, print, or download the latest manual or manual supplement, go to our website.

Fluke Corporation  
P.O. Box 9090  
Everett, WA 98206-9090

+1-425-446-5500

[fluke-info@fluke.com](mailto:fluke-info@fluke.com)

## Safety Information

General Safety Information is in the printed Safety Information document that ships with the Product and at [www.fluke.com](http://www.fluke.com). More specific safety information is listed where applicable.

A **Warning** identifies hazardous conditions and procedures that are dangerous to the user. A **Caution** identifies conditions and procedures that can cause damage to the Product or the equipment under test.

## Specifications

For a list of the complete specifications go to [www.fluke.com](http://www.fluke.com).

## Product Familiarization

Before you use the Product, read through this manual to familiarize yourself with all the features, accessories, and operation.

### Features

The Product has these features:

- Bright 7" high resolution LCD touch screen.
- High Definition, dual view imaging probe and adjustable light to provide a clear image.
- Large variety of rugged and high resolution accessory probes to address your specific application needs.
- Macro to micro zoom
- Up-is-Up™ technology for an appropriate orientation, regardless of the probe location or position
- Asset ID tagging allows you to easily compare asset images over time.
- Fluke Connect™ support that includes wireless image transfer.



## In the Box

Table 1 shows the Product and the standard accessories.

**Table 1. Standard Accessories**



Item	Description	Item	Description
1	Control panel	6	Neck strap
2	Hand strap	7	USB cable
3	LCD screen (display)	8	HDMI cable
4	8.5 mm HD DUALVIEW Probe	9	T-Pak magnetic hanger
5	USB charger	not shown	Documentation: Safety Information and Quick Reference Guide

Table 2 shows the connections of the Product.

**Table 2. Connections**

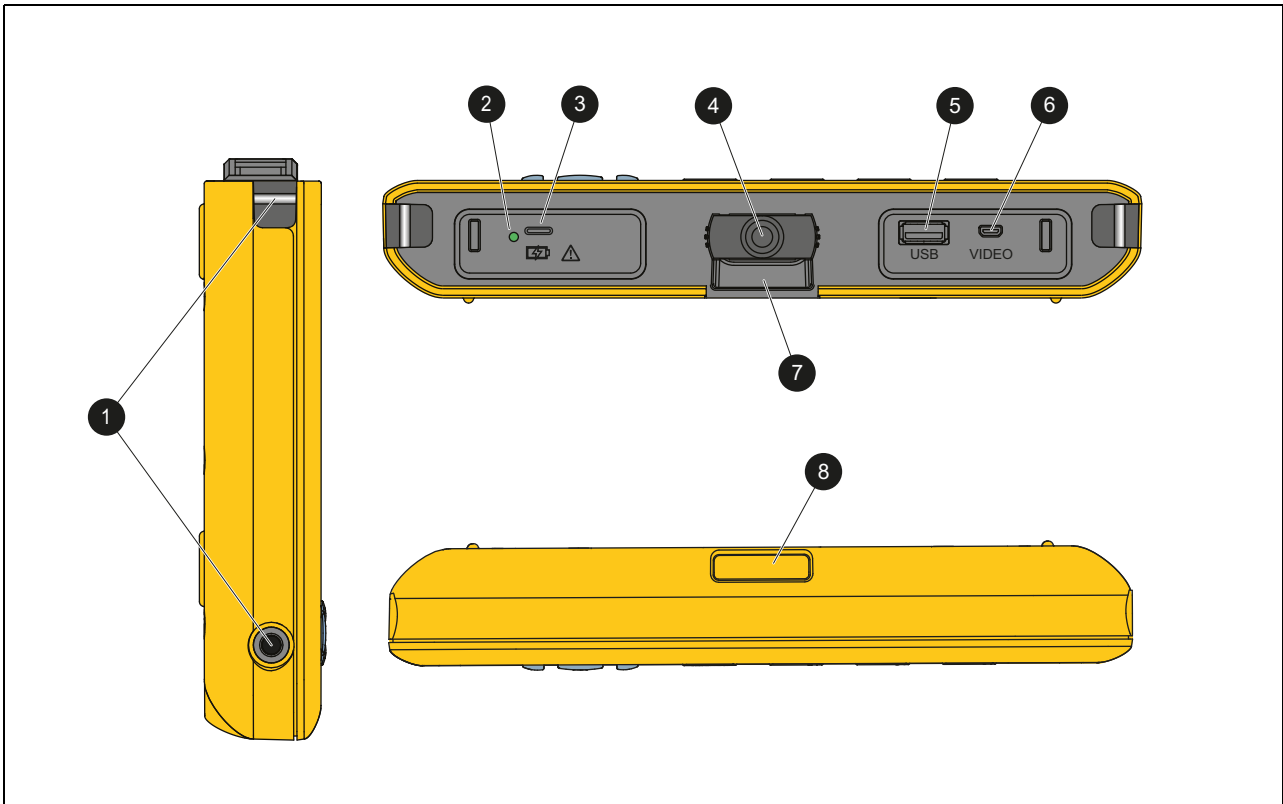

Item	Description	Item	Description
1	Anchors for hand strap	5	USB A input
2	Charging LED	6	HDMI input
3	USB-C input	7	Anchor for T-Pak magnetic hanger
4	Probe input	8	Anchor for neck strap

Table 3 shows the parts of the 8.5 mm HD DUALVIEW probe that is included with the Product.

**Table 3. Probe**

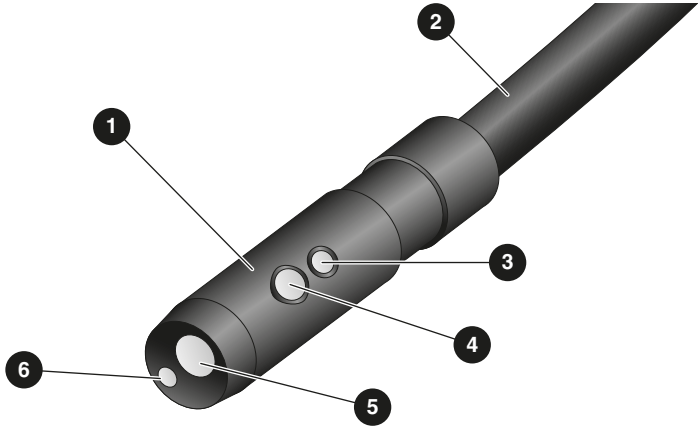
			
Item	Description	Item	Description
<b>1</b>	Probe head	<b>4</b>	Side LED
<b>2</b>	Probe cable, 1.2 m	<b>5</b>	Forward camera
<b>3</b>	Side camera	<b>6</b>	Forward LED

## Accessories

Table 4 is a list of the accessories available for the Product.









**Table 4. Accessories**

Video Borescope Probe	Description	PN
FLK-3.8MM PROBE, 1M, FORWARD VIEW	3.8 mm wide, 1 m long high definition imaging probe with a forward view lens.	4962690
FLK-5.5MM PROBE, 1M, DUAL VIEW	5.5 mm wide, 1 m long high definition imaging probe with forward and side view camera lenses.	4962713
FLK-8.5MM PROBE, 3M, DUAL VIEW <sup>[1]</sup>	8.5 mm wide, 1.2 m long high definition imaging probe with forward and side view camera lenses.	4962708
FLK-5.5MM/0.7M SCOPE, WITH ARTICULATING PROBE	5.5 mm wide, One Way Articulation, 0.7 m long	5344767
FLK-9MM PROBE, FORWARD VIEW 20M, REEL	20 m reel for probe storage.	4962760
[1] Compatible with Up-is-Up™ technology.		

## Display

Use the control panel (see [Control Panel](#)) to select an icon to change parameters or select functions and options. Use the touch screen as a shortcut to common settings. The display has a backlight for work in dimly-lit spaces. Table 5 lists the functions of the icons on the display.





















**Table 5. Display**

Icon	Description	Touch Screen Function
	Primary menu	Tap to open the Primary menu.
	Memory menu	Tap to review or delete captured images and videos.
	Image mode	Tap to capture an image. See <a href="#">Capture an Image</a> .
	Video mode	Tap to start recording a video. Tap again to stop recording a video. See <a href="#">Record a Video</a> .
	Forward/side camera control	Tap to toggle between the front and side camera.
	Battery status	Shows the battery level.
	Zoom control	Touch, hold, and move to the left or right to zoom in or out. To open this feature, see <a href="#">Control Panel</a> .
	Flashlight brightness control	Touch, hold, and move to the left or right to increase or decrease the brightness of the flashlight. To open this feature, see <a href="#">Control Panel</a> .
	Back arrow	In the primary menu, tap to go back to live view. In a submenu, tap to go back to the previous menu.

## Control Panel

Use the control panel to change parameters or select functions and options. Table 6 lists the functions of the buttons on the Control Panel.

**Table 6. Control Panel**

Button	Home Screen Function
	Push to turn on or off the Product.
<b>F1</b>	NA
<b>F2</b>	Push to open the Primary menu (  ).
<b>F3</b>	Push to turn on or off the zoom control (  ). Use  /  to zoom in or out.
<b>F4</b>	Push to turn on or off the flashlight brightness control (  ). Use  /  to increase or decrease brightness.
	With the zoom and flashlight brightness controls off, push to highlight  ,  ,  /  , or  /  .
<b>SELECT</b>	<p>With the Primary menu () or the Memory menu () highlighted, push to open the selected menu.</p> <p>With  highlighted, push to capture an image. See <a href="#">Capture an Image</a>.</p> <p>With  highlighted, push to record a video. See <a href="#">Record a Video</a>.</p> <p>With  /  highlighted, push to toggle between the front and side cameras.</p>

## Basic Operation

Before you use the Product for the first time, see [Charge the Battery](#).

To use the Product, attach the probe to the probe input. See Table 1.

### Capture an Image

To capture an image:

1. Use the arrow keys to highlight .
2. Push **SELECT** to capture an image.

The display flashes briefly, and the image saves to memory.

## Record a Video

To record a video:

1. Select **Menu > Image > Video > Done > Cancel** to select video mode and return to the home screen.
2. Push **SELECT** to start recording a video.
3. Push **SELECT** again to stop recording a video.  
The video saves to memory.

## Menus

Use the menus to change and view settings.

To change settings:

1. Push **F2** to open the Primary menu
2. Push **F1** to open the Image menu, or push **F2** to open the Setup menu.
3. Push **▼ / ▲** to select an option.
4. If needed, push **▶** to open a submenu.
5. Push **F1**, **F2**, or **F3** to select an option.
6. Push **F4** to set the option and return to the previous screen.

## Primary Menu

Table 7 lists the secondary menus available in the Primary Menu.

**Table 7. Primary Menu**

Secondary Menu	Description
<b>Image</b>	Set features used to show images on the display and in some saved image and video files.
<b>Setup</b>	Set user preferences.
<b>Cancel</b>	Select to return to live view. Does not cancel changes.

## Image Menu

Table 8 lists the options in the Image menu.

**Table 8. Image Menu**

Option Menu	Option	Description
<b>Image Mode</b>	<b>Image</b>	Select to set up the Product to capture an image.
	<b>Video</b>	Select to set up the Product to record a video.
<b>View Mode</b>	<b>True Color</b>	Select to set the view mode.
	<b>Texture</b>	Use True Color to differentiate similar colors from each other. Use Texture to emphasize the texture of the target.
	<b>UV</b>	Use UV to identify leak detection with UV dye. Images are clearer when used with the UV accessory.
	<b>Inspection</b>	Use Inspection to Identify cracks, wear points, and fine print.
<b>Color</b>	<b>Standard</b>	Select to set the color palette.
	<b>Grayscale</b>	
	<b>Inverted</b>	
<b>Rotate</b>	<b>180</b>	Select to rotate the image 180 °.
	<b>None</b>	Select to view the image with no rotation.
<b>Up is Up</b>	<b>On</b>	Select to rotate the image automatically so the orientation of the image on the display is upright regardless of the position of the probe. With <b>On</b> activated, use the Product to: <ul style="list-style-type: none"> <li>• View text such as serial numbers.</li> <li>• Identify the location of items in relation to each other. For example, if switch A is located to the right of switch B, switch A shows on the display to the right of switch B.</li> </ul>
	<b>Off</b>	Select to view the image with no orientation correction.

## Setup Menu

Table 9 lists the options in the Setup menu.

**Table 9. Setup Menu**

Option Menu	Option	Description
<b>Auto Off</b>	<options>	Sets the time before the Product automatically turns off.
<b>Time Stamp</b>	<b>ON</b>	Turns on/off the time stamp on image and video files.
	<b>OFF</b>	
<b>Backlight</b>	<options>	Sets the brightness level of the display.
<b>Date/Time</b>	<options>	Sets the date format and the date. See <a href="#">Date</a> . Sets the time format and the time. See <a href="#">Time</a> .

**Table 9. Setup Menu (cont.)**

Option Menu	Option	Description
Fluke Connect	Wifi (ON)	Turns on or off WiFi. Select <b>WiFi ON</b> to pair the Imager to the Fluke Connect app on a mobile device or to other Fluke Connect tools. See <a href="#">Fluke Connect</a> .
	Wifi (OFF)	<i>Note</i> <i>The Fluke Connect system is not available in all countries.</i>
Data storage	Internal	Saves files to the internal memory.
	USB	Saves files to a USB storage device.
	Eject USB	With <b>USB</b> enabled, use to safely remove a USB device.
Language	<options>	Sets the language to use on the display.

## Date

The date shows as: **MM/DD/YY**, **DD/MM/YY** or **YYYY/MM/DD**.

To set the date:

1. Select **Menu > Setup > Date/Time**.
2. Push **F2** to open the Date Format menu.
3. Select **MM/DD/YY**, **DD/MM/YY** or **YYYY/MM/DD**.
4. Push **▶** to open the set date option menu.
5. Push **◀ / ▶** to select the day, month, or year.
6. Push **▼ / ▲** to change the day, month, or year.
7. Push **F4** to set the date and return to the previous menu.

## Time

Time shows as: **12 hour** or **24 hour**.

To set the time format:

1. Select **Menu > Setup > Date/Time**.
2. Push **F3** to open the Time Format menu.
3. Select **12 hour** or **24 hour**.
4. Push **▶** to open the set time option menu.
5. Push **◀ / ▶** to select the minutes or hours.
6. Push **▼ / ▲** to change the minutes or hours.
7. If you selected the 12 hour format, select **AM** or **PM**.
8. Push **F4** to set the time and return to the previous menu.



## Fluke Connect

The Product supports the Fluke Connect Wireless system. The Fluke Connect system wirelessly connects your Fluke test tools with an app on a mobile device. Use the app to download images saved on the Product and then view on your mobile device.

*Note*

*The Fluke Connect system is not available in all countries.*

The Fluke Connect app works with Apple and Android products. The app is available for download from the Apple App Store and Google Play.

To use the Fluke Connect app with the Product:

1. On the Product:
  - a. Capture an image.
  - b. Select **Menu > Setup > Fluke Connect > Wifi (ON)**.
2. On the mobile device:
  - a. Download the Fluke Connect app.
  - b. Go to **Settings > Wi-Fi**.
  - c. Select the Wi-Fi network that begins with **FLUKE...**
  - d. In the password field, enter **fluketools**.
3. On the Fluke Connect app:
  - a. Select **DS703 FC <Serial Number>** from the list. The serial number is located on the back of the Product.
  - b. Follow the directions in the app.

*Note*

*Videos cannot be viewed on the app.*

Go to [www.flukeconnect.com](http://www.flukeconnect.com) for more information about how to use the app.

## Memory Menu



Use the Memory menu to review or delete captured image and video files.

### Review Image or Video

To review an image:

1. Use the arrow keys to highlight the Memory menu (.
2. Push **SELECT** to open the Memory menu.
3. Use the arrow keys to select the preview image of the file for review.
4. Push **F1** to review the file.
5. If needed, push **F2** to zoom in or push **F3** to zoom out.

To review a video:

1. Use the arrow keys to highlight the Memory menu (  ).
2. Push **SELECT** to open the Memory menu.
3. Use the arrow keys to select the preview image of the file for review. All video files show  on the thumbnail.
4. Push **F1** to review the file.
5. Push **F1** to play the video.

### Delete Image

To delete images, see Table 10.

**Table 10. Delete Images**

Action	Procedure
Delete one file	<ol style="list-style-type: none"><li>1. Open the Memory menu.</li><li>2. Select a preview image.</li><li>3. Push <b>F2</b> to open the Delete menu. The Product prompts you to delete or cancel.</li><li>4. Push <b>F2</b> again to delete the file.</li></ol>
Delete all files	<ol style="list-style-type: none"><li>1. Open the Memory menu.</li><li>2. Push <b>F3</b> to select <b>Delete All</b>. The Product prompts you to delete or cancel.</li><li>3. Push <b>F2</b> to delete all the files from the memory.</li></ol>

## View Images or Videos

You can view images and video on a PC or with an HDMI-compatible device. With Fluke Connect you can view images but not videos.

### View on a PC

To view saved files on a PC through a USB connection:

1. Connect the USB A connector end of the USB cable into your PC and the USB-C connector end of the USB cable into the Product.  
The PC will register the Product as a USB device.
2. On the PC, select the file to review.

## View on an HDMI Device

HDMI (High-Definition Multimedia Interface) is a compact audio/video interface that transfers uncompressed data and compressed/uncompressed digital audio data from the Product to a compatible HDMI device.

To view saved files on an HDMI device:

1. Attach the included HDMI cable to the HDMI input on the Product.
2. Connect the other end to an HDMI video device.
3. On the video device, select the HDMI port number that the HDMI cable is attached to.
4. On the Product, select the file to view.

## View with Fluke Connect

To view saved files in the Fluke Connect app, see [Fluke Connect](#).

## Update Firmware

For firmware updates, Fluke recommends that you use Fluke Connect Desktop Software. See [Fluke Connect Desktop Software](#).

## Fluke Connect Desktop Software

Go to <http://en-us.fluke.com/support/software-downloads/ti-fc-software-update.html> for more information about how to use Fluke Connect Desktop Software with the Product.

## Neck Strap

Use the neck strap to carry the Product for an extended period of time. See Figure 1.

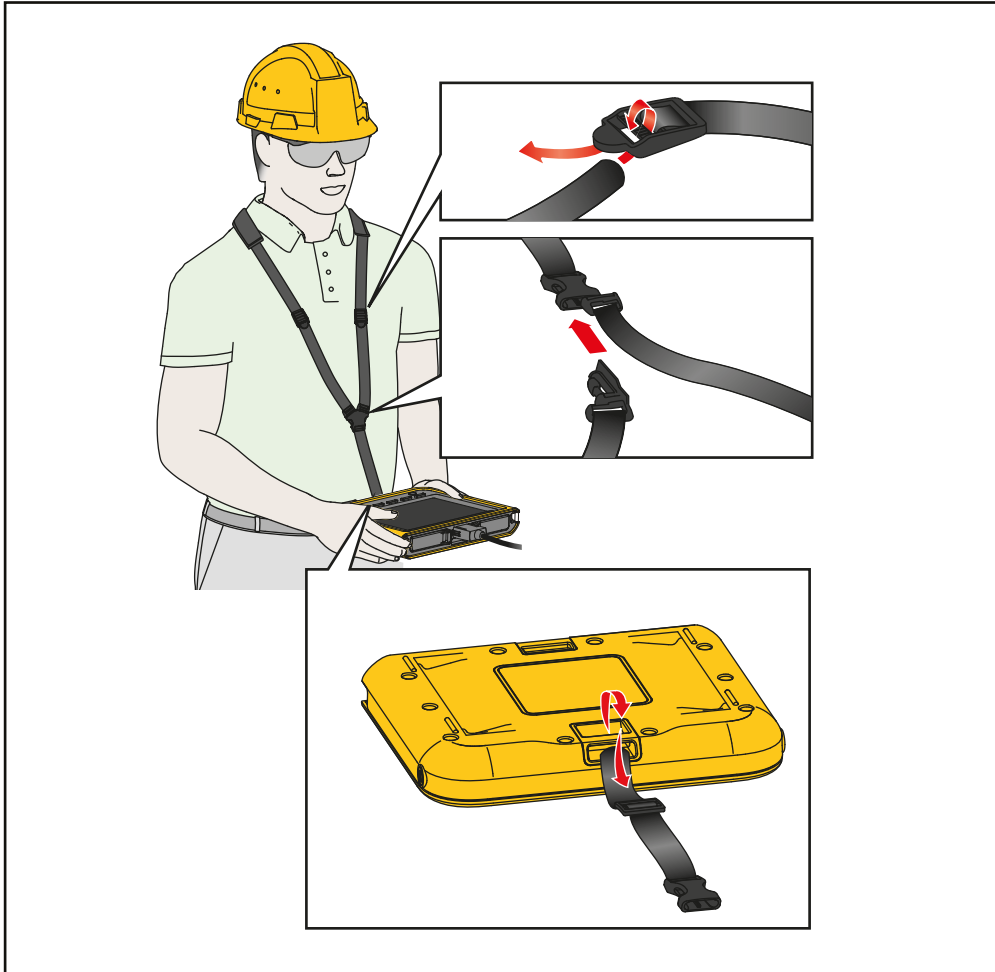

Figure 1. Adjustable Neck Strap

## Maintenance

To maintain the Product, clean the case and lenses and charge the batteries.

**⚠ Caution**

**To prevent damage to the Product, do not drop the Product. Treat the Product as a calibrated instrument.**

## Clean the Product

### Caution

**To prevent damage to the Product, do not use abrasives, isopropyl alcohol, or solvents to clean the case or lenses.**

Clean the case with a damp cloth and a weak soap solution. To clean the lenses, use a pressurized can of air or a dry nitrogen-ion gun, if available, to blow off the particulates from the lenses.

## Charge the Battery

Before you use the Product for the first time, charge the battery for  $\geq 2.5$  hours. See Figure 2.

### Note

*New batteries are not fully charged. Make sure that the Product is near room temperature before you connect the Product to the charger. See the charging temperature specification. Do not charge in hot or cold areas. When you charge in extreme temperatures, battery capacity may decrease.*

To charge the battery with the Product on:

1. Connect the USB A connector end of the USB cable into the USB charger.
2. Connect the USB charger into an ac wall outlet and connect the USB-C connector end into the USB-C input on the Product.

 shows on the display when the battery is charging.

 shows on the display when the battery is fully charged.

3. Disconnect the USB cable from the Product.

To charge the battery with the Product off:

1. Turn off the Product.
2. Connect the USB A connector end of the USB cable into the USB charger.
3. Connect the USB charger into an ac wall outlet and connect the USB-C connector end into the USB-C input on the Product.

The LED blinks while charging and turns solid green when charging is complete. See [Table 2](#).

4. Wait  $\geq 2.5$  hours for the Product to charge.
5. Disconnect the USB cable from the Product.
6. Turn on the Product.

 shows on the display when the battery is fully charged.

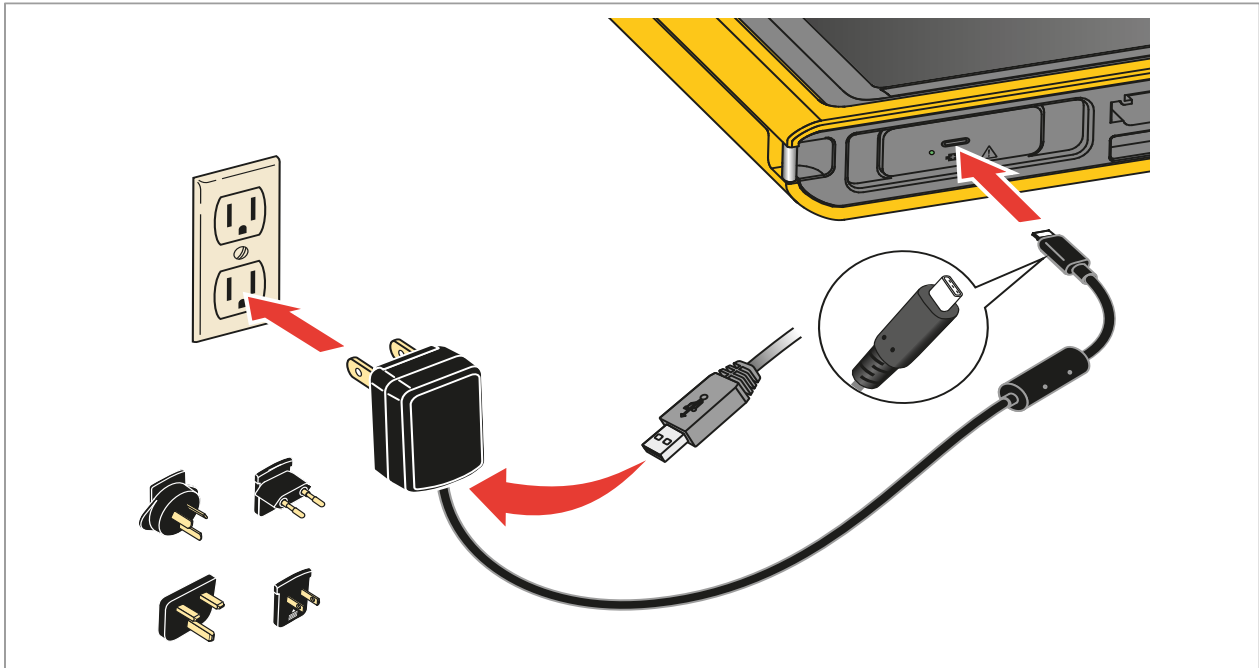

**Figure 2. Charge the Battery**

## Product Disposal

Dispose of the Product in a professional and environmentally appropriate manner:

- Delete personal data on the Product before disposal.
- Remove batteries that are not integrated into the electrical system before disposal and dispose of batteries separately.
- If this Product has an integral battery, put the entire Product in the electrical waste.

## Radio Frequency Data

To view the Radio Frequency Data Class B Instruction Sheet, go to <http://us.fluke.com/usen/support/manuals> and search for 4409209.