

# FLAMECLUB



# 2023

## CATALOGUE





## SOFTFLAME

**SOFTFLAME** or also called regular flame is the most common of all known flame types. It is generated by a piezo or flint wheel ignition. The optimum height of a softflame is approx. 3cm.



## COLORFUL TURBOFLAME

**TURBOFLAME** The windproof burning behaviour is the mark of distinction of turbo flames. Above a nozzle the lighter gas is mixed with air, swirled inside the diffuser and ignited by an electrode. The mixture burns like a Bunsen burner with great heat, but without a visible flame. In general the same technique as used for the classic turbo flame. The only difference is the special magnesium wire that creates the interesting colorful flame.



## JETFLAME

**JETFLAME** is probably the hottest flame available at present. Due to the fact that gas and air are swirled above a nozzle through a special burner type, the sharp and pointed flame is created. And such JETFLAME is normally use for cigars or other professional ways.



To pass the **HEAT TEST** lighters have to withstand 4 hours in a special oven at 65°C. Thereby they may not get any splits or Leaks of gas.



The **DROP TEST** indicates the ability of the lighter to withstand safely a drop from 1.5 m in a group of concrete without splitting.



According to the outside temperature the **FLAME HEIGHT** of lighters varies in use. The maximum flame height may not exceed 10 cm.



The **ISO22702** is a world-wide valid Norm which states the demands within the general product safety for utility lighters. It consists basically on three test methods (**HEAT TEST, DROP TEST, FLAME HEIGHT**) that an utility lighter has to pass before being placed on the market. **ISO22702** certification can be provided upon request.



All **FLAMECLUB** packs carry the **ISO22702 Norm** required warning and safety pictograms clearly printed.



**FLAMECLUB** utility lighters are produced in **TÜV** monitored factories. All the production must pass stringent certified and integrated quality management.





# DESCRIPTION

- |                        |                               |                              |                      |
|------------------------|-------------------------------|------------------------------|----------------------|
| <b>GB</b> Gas lighter  | <b>DK</b> Gaslighter          | <b>RU</b> Газовая зажигалка  | <b>TR</b> gaz çakmak |
| <b>DE</b> Gasanzünder  | <b>PL</b> Zapalarka gazowa    | <b>UA</b> Газова запальничка | <b>AR</b> ولاعة غاز  |
| <b>FR</b> Allume-gaz   | <b>PT</b> Isqueiro multiusos  | <b>GR</b> Αναπτήρας          | <b>JA</b> ガスライター     |
| <b>ES</b> Encendedor   | <b>CZ</b> Plynový zapalovač   | <b>BG</b> Газова запалка     | <b>KO</b> 가스 라이터     |
| <b>NL</b> Gasaansteker | <b>SE</b> Tändare för gaslåga | <b>HU</b> Gázgyújtó          | <b>ZH-CN</b> 点火器     |
| <b>IT</b> Accendigas   | <b>RO</b> Brichetă pe gaz     | <b>HR</b> plinski upaljac    | <b>ZH-HK</b> 點火器     |

Our utility lighters have multiple purpose for barbecues, candles, kitchen oven and fireplaces, it's an unique product for lifestyle.



Our **FLAMECLUB** design of utility lighter is focus to the request of the final market.

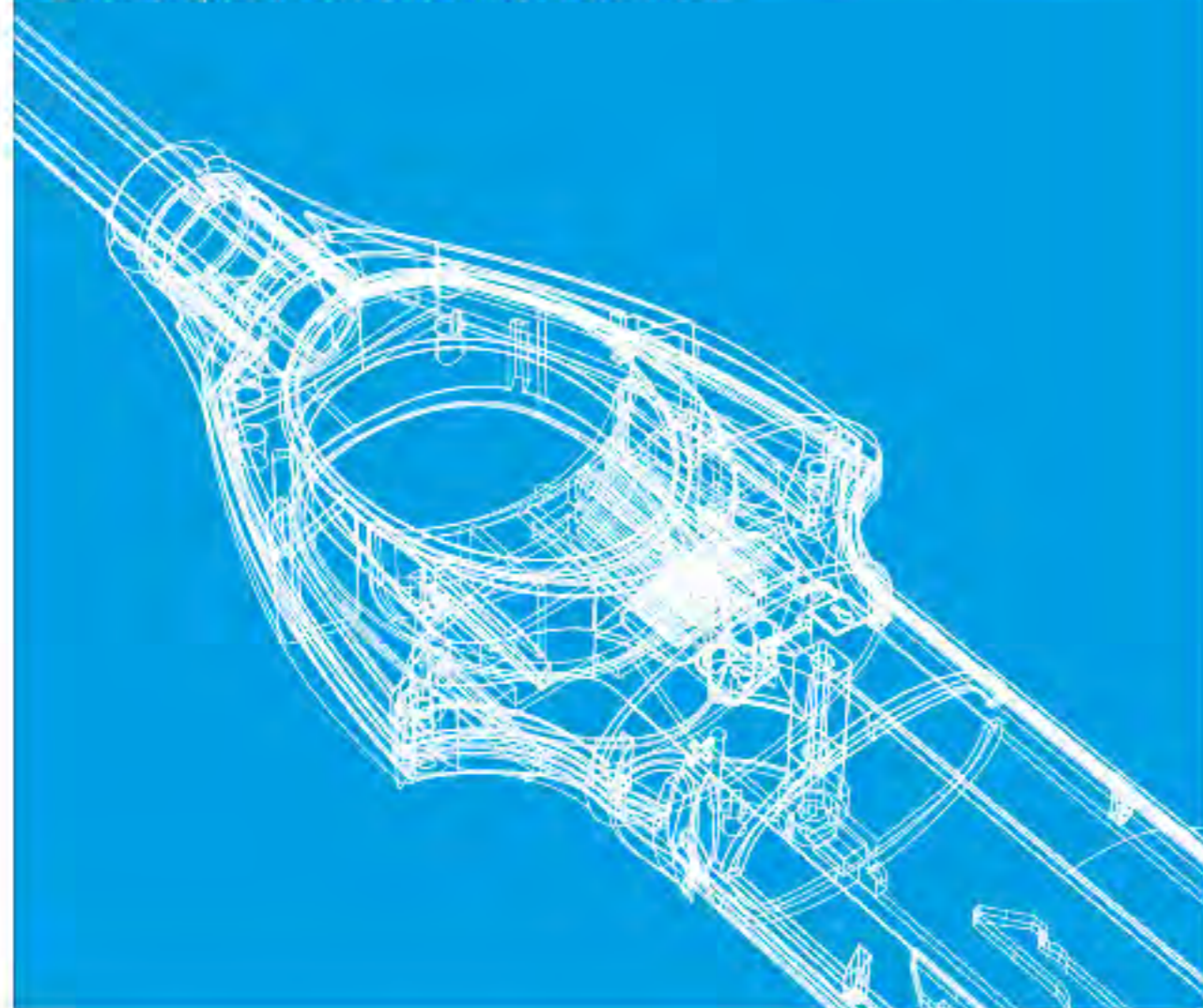

Our **FLAMECLUB** utility lighter are available on child-resistant with two-step ignition. The mechanism had been approved by CPSC of USA.



# PICTOGRAMS

- |  |  |
|--|--|
| <b>SOFTFLAME</b> Soft Flame                | With Bottle Opener                       |
| <b>COLOR TURBO</b> Turbo Flame             | With Led Light                           |
| <b>JETFLAME</b> Jet Flame                  | <b>GAS</b> Gas Refillable                |
| Flexible Tube                              | <b>GAS REFILLABLE</b> Disposable         |
| <b>SPARK</b> Spark Lighter                 | Flame Adjustable                         |
| <b>BATTERY IGNITION</b> Battery Operated   | <b>RoHS</b> RoHS Certificate             |
| With Magnet                                | <b>DESIGN PATENTED</b> Registered Patent |
| <b>85% CHILD-RESISTANT</b> Child Resistant |  |

# COLORANNOTATION

- |            |                    |
|------------|--------------------|
| <b>HC</b>  | SOLID (HARD) COLOR |
| <b>TC</b>  | TRANSPARENT COLOR  |
| <b>ST</b>  | TRANSLUCENT COLOR  |
| <b>MT</b>  | MATT COLOR         |
| <b>MC</b>  | METALLIC COLOR     |
| <b>MI</b>  | MIRROR SURFACE     |
| <b>RC</b>  | RUBBERIZED COLOR   |
| <b>ALU</b> | ALUMINUM           |
| <b>SL</b>  | SLEEVE LABEL       |
| <b>DL</b>  | DESIGNER LABEL     |



Birdy

HC Maxi Assorted



28100 / Maxy Color 5 Assorted / Display  
Black Tube / Colored Pusher

Birdy

TC Assorted



28101 / TC 5 Assorted / Display  
Black Tube / Grey Pusher

Birdy

Candy Colors Assorted



28102 / Candy Colors Assorted / Display  
Black Tube / Black Pusher

Birdy

TC Colors / 2-Pack



28125 / TC Assorted / 2-Pack Blister  
Black Tube / Grey Pusher

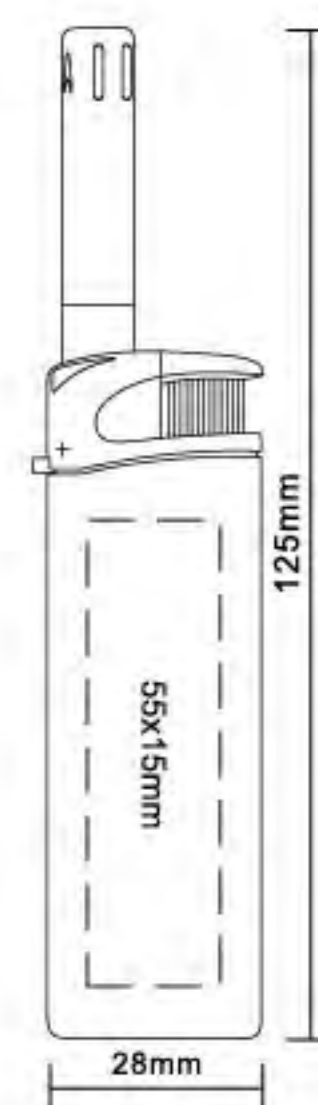

Article nr.	Tray	Barcode Product	Innerbox	Barcode Innerbox	Export Carton	Barcode Exp. Cart.	Pallet
28100	25 pcs	4895151801660	25 pcs	4895151800328	400 pcs	4895151800335	14.400 pcs
28101	25 pcs	4895151811638	25 pcs	4895151811645	400 pcs	4895151811652	14.400 pcs
28102	25 pcs	4895151855069	25 pcs	4895151855076	400 pcs	4895151855083	14.400 pcs
Article nr.	Blister	Barcode Product	Innerbox	Barcode Innerbox	Export Carton	Barcode Exp. Cart.	Pallet
28125	1 pcs	4895151855014	24 pcs	4895151855021	96 pcs	4895151855038	- pcs



## Comfort

## HC Assorted



97002W / HC 4 Assorted / Blister  
Black Tube / Grey Pusher

## Comfort

## ST Assorted



97003W / ST 4 Assorted / Display  
Black Tube / Grey Pusher

## Comfort FLEX

## MC Assorted / Flexi Tube



97602 / Metallic 4 Assorted / Blister  
Chrome Flexi Tube / Silver Pusher

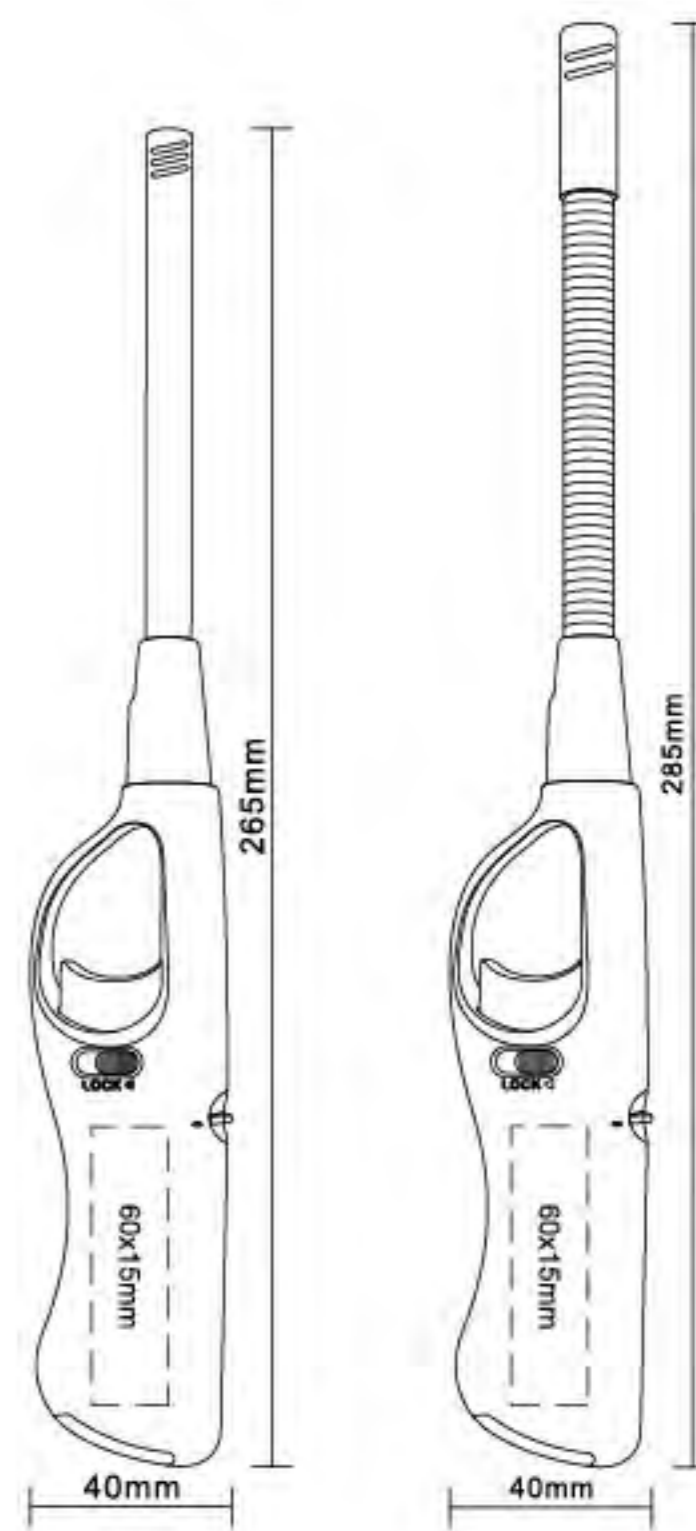

Article nr.	Blister	Barcode Product	Innerbox	Barcode Innerbox	Export Carton	Barcode Exp. Cart.	Pallet
97002W	1 pcs	4895151817432	24 pcs	4895151817463	96 pcs	4895151817494	2.880 pcs
97602W	1 pcs	4895151820500	24 pcs	4895151820517	96 pcs	4895151820524	2.880 pcs
Article nr.	Display	Barcode Product	Innerbox	Barcode Innerbox	Export Carton	Barcode Exp. Cart.	Pallet
97003W	1 pcs	4895151817449	24 pcs	4895151817470	96 pcs	4895151817500	3.456 pcs



Daily

HC Assorted



56001W / HC 4 Assorted / Blister  
Black Tube / Grey Pusher

Daily

HC Assorted



56007W / HC 5 Assorted / Display  
Black Tube / Colored Pusher

Daily FLEX

HC Assorted / Flexi Tube



56601J / HC 4 Assorted / Blister  
Black Flexi Tube / Grey Pusher

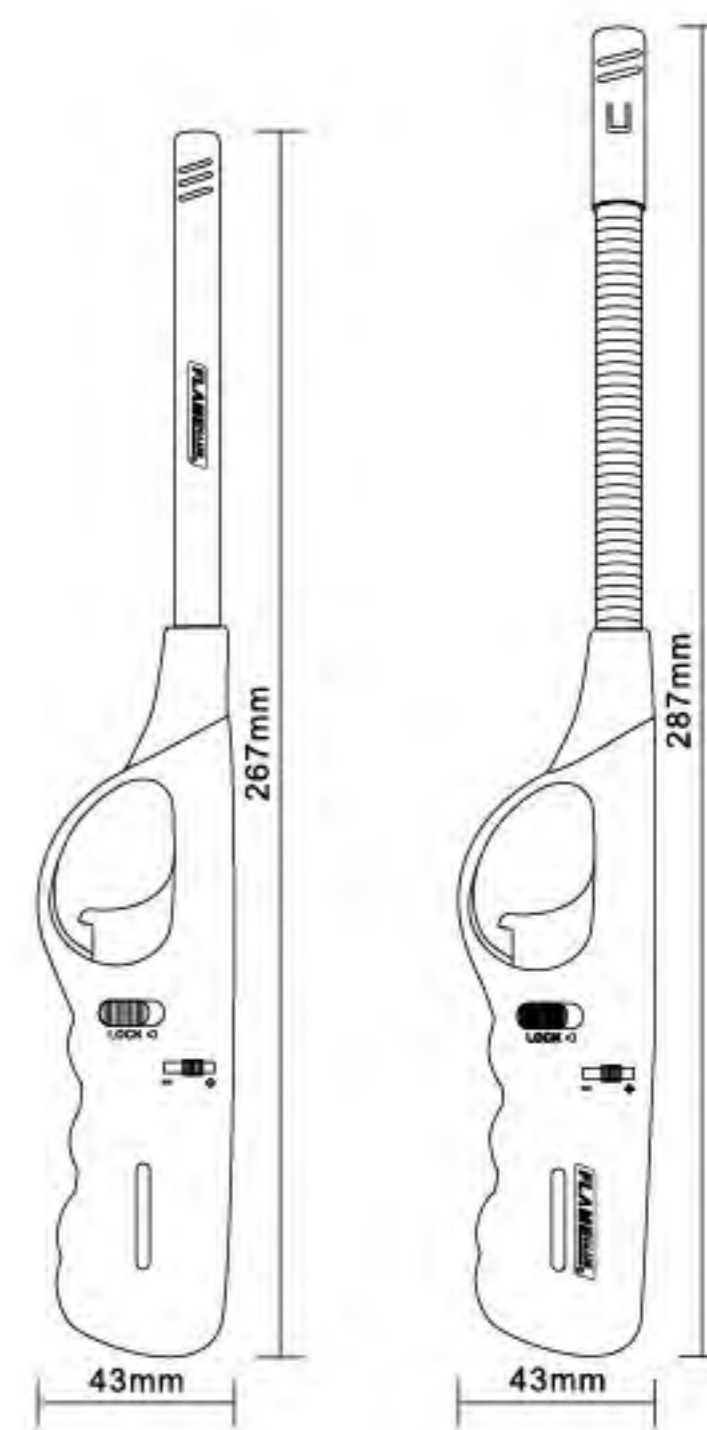

    							
							
Article nr.	Blister	Barcode Blister	Innerbox	Barcode Innerbox	Export Carton	Barcode Exp. Cart.	Pallet
56001W	1 pcs	4895151820531	24 pcs	4895151820548	144 pcs	4895151820555	2.880 pcs
56601J	1 pcs	4895151820593	24 pcs	4895151820609	96 pcs	4895151820616	3.456 pcs
							
Article Nr.	Display	Barcode Product	Innerbox	Barcode Display	Export Carton	Barcode Exp. Cart.	Pallet
56007W	24 pcs	4895151817449	24 pcs	4895151836464	96 pcs	4895151836471	3.456 pcs



## New Easy Flame

## HC Assorted



93000N / HC 4 Assorted / Display  
Black Tube / Black Pusher

## New Easy Flame

## ST Assorted



93001N / ST 4 Assorted / Display  
Black Tube / Black Pusher

## New Easy Flame

## HC Assorted / Flexi Tube



93600N / HC 4 Assorted / Blister  
Black Flexi Tube / Black Pusher

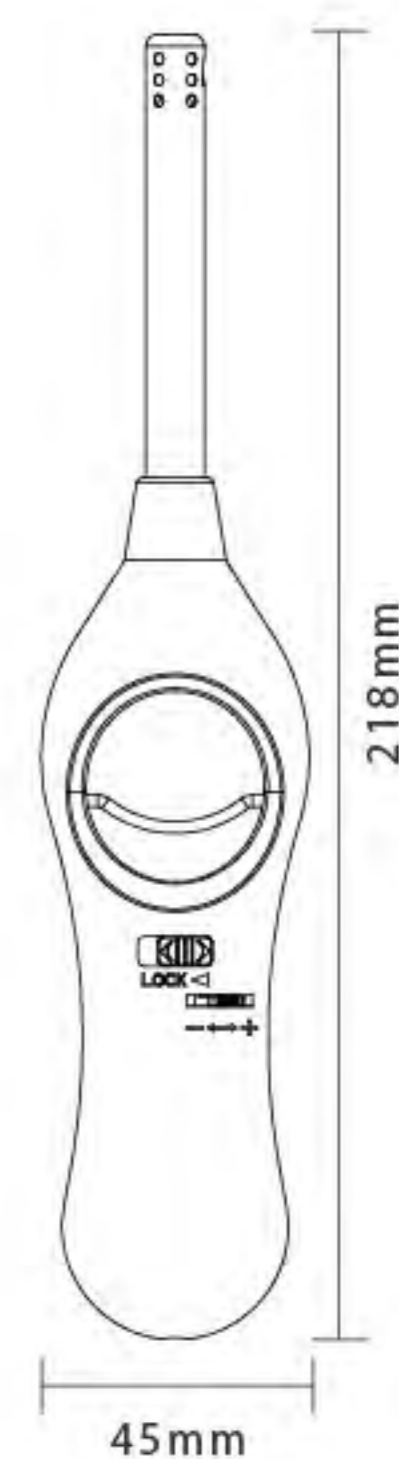

Article Nr.	Display	Barcode Product	Innerbox	Barcode Display	Export Carton	Barcode Exp. Cart.	Pallet
93000N	24 pcs	4895151809352	24 pcs	4895151809369	96 pcs	4895151809376	3.456 pcs
93001N	24 pcs	4895151809857	24 pcs	4895151809864	96 pcs	4895151809871	3.456 pcs
Article Nr.	Blister	Barcode Product	Innerbox	Barcode Display	Export Carton	Barcode Exp. Cart.	Pallet
93600N	1 pcs.	4895151854987	24 pcs.	4895151854994	96 pcs.	4895151855007	3.456 pcs.







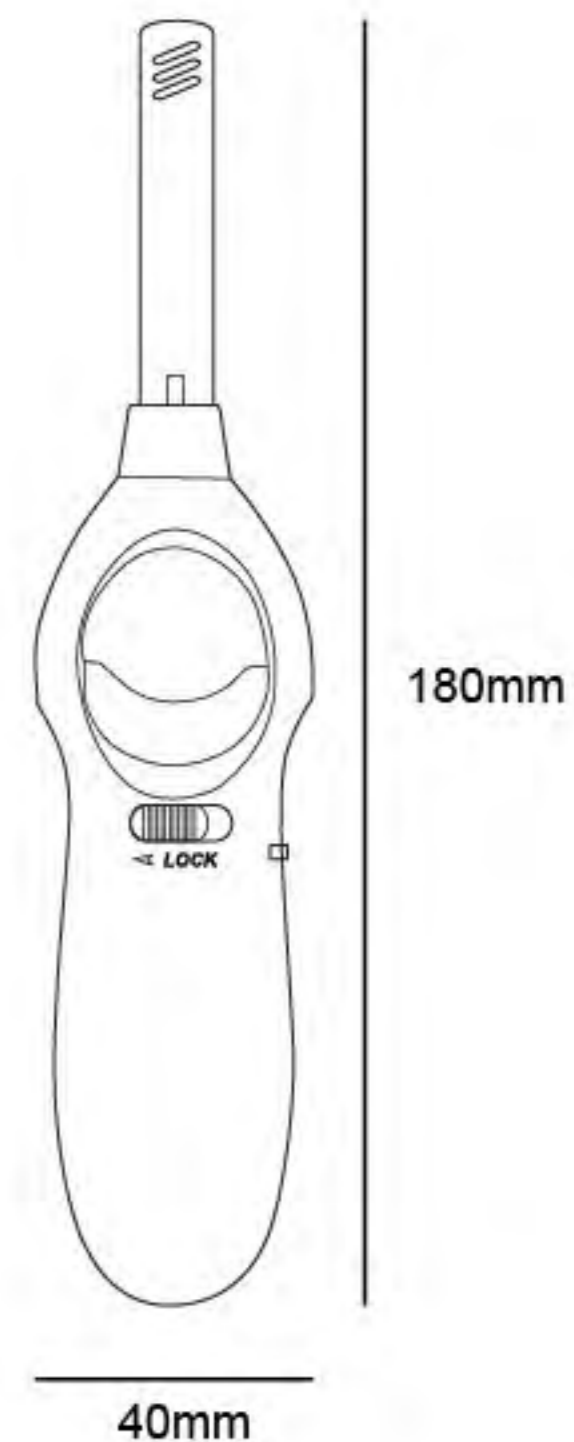







GEO

HC Assorted



91801 / HC 4 Assorted / Blister  
Black Tube / Black Pusher

    							
							
Article Nr.	Blister	Barcode Product	Innerbox	Barcode Display	Export Carton	Barcode Exp. Cart.	Pallet
91801	1 pcs	4895151854956	24 pcs	4895151854963	144 pcs	4895151854970	3.456 pcs



# DESCRIPTION

- |                                 |                                 |                                 |                           |
|---------------------------------|---------------------------------|---------------------------------|---------------------------|
| <b>GB</b> Utility burner        | <b>DK</b> Utility brænder       | <b>RU</b> Утилита горелки       | <b>TR</b> Programı brülör |
| <b>DE</b> Utility-Brenner       | <b>PL</b> palnik Utility        | <b>UA</b> Утилита пальники      | <b>AR</b> مشعل موقد       |
| <b>FR</b> brûleur Utility       | <b>PT</b> gravador de Utilidade | <b>GR</b> Χρησιμότητα καυστήρα  | <b>JA</b> キッチンバーナー        |
| <b>ES</b> Utilidad del quemador | <b>CZ</b> Utility hořák         | <b>BG</b> Предприятието горелка | <b>KO</b> 부엌 버너           |
| <b>NL</b> Utility-brander       | <b>SE</b> Utility brännare      | <b>HU</b> Utility égő           | <b>ZH-CN</b> 多功能燃烧器       |
| <b>IT</b> Utility bruciatore    | <b>RO</b> Utilitate arzător     | <b>HR</b> Utility plamenik      | <b>ZH-HK</b> 多功能燃烧器       |

# PICTOGRAMS

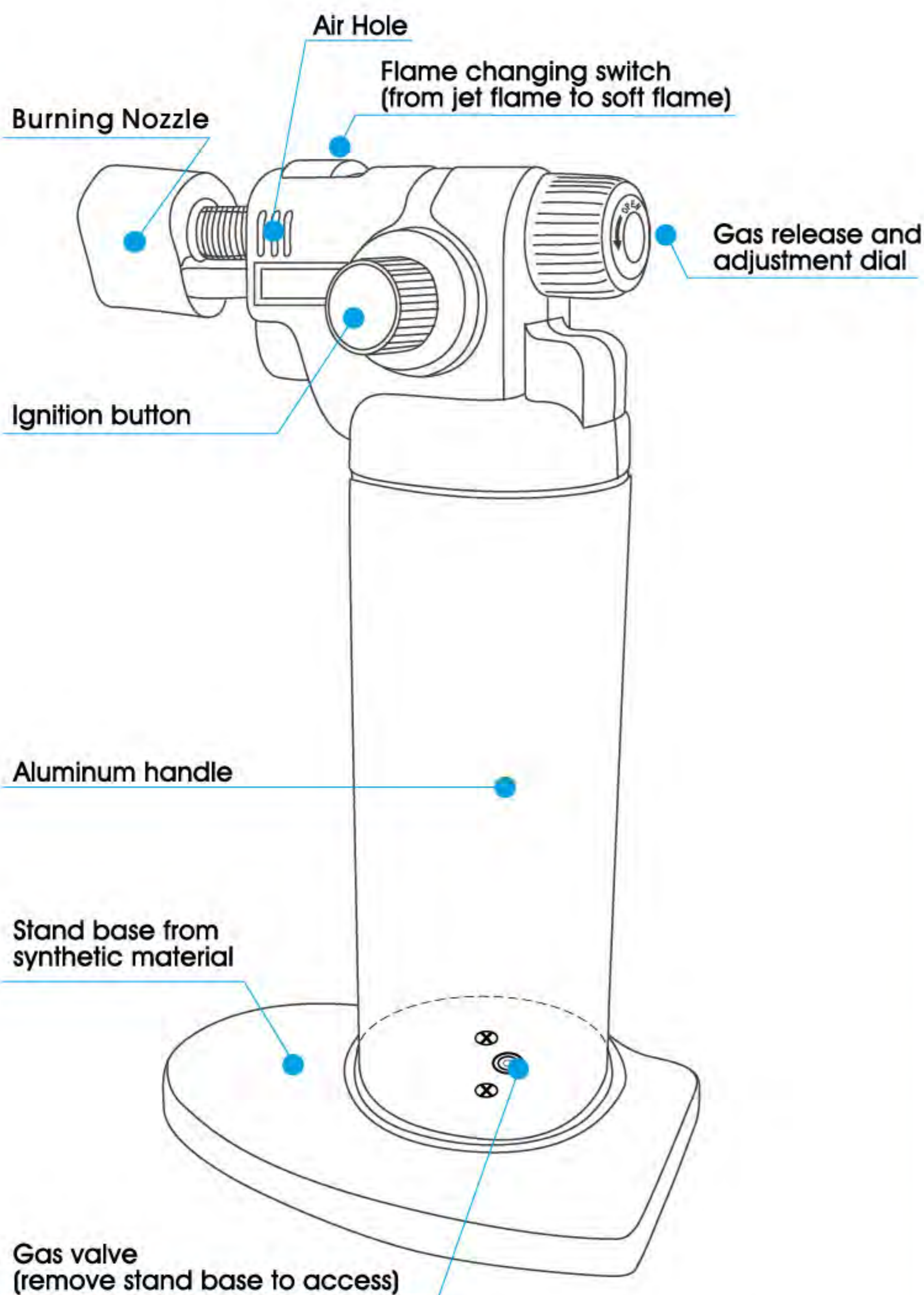

## CLOSE-UP OF MT-80 UTILITY MICRO-TORCH

# UTILITY MicroTorch

Dear Clients,

Thank you for looking the high quality Utility Burner by FLAMECLUB. It's a wise choice and one that will prove the test of time as a durable top quality product. To make sure you get optimum results and long-lasting service from our Utility Burner, we will provide some important information plus tips for optimal use and aftercare, as well as safety guidelines.

### Outstanding product features at a glance:

The Utility Burner from FLAMECLUB is a reliable and durable flame appliance for producing caramel from all types of sugar on desserts such as Crème Brûlée, Crema Catalana or even ice cream (which maintains its cold temperature under a sugar layer), as well as for vegetables or meat. The Utility Burner is ideal for browning meringues, topping off gratin and removing skin from tomatoes or peppers.

- > Adjustable gas dial for controlled application
- > Quick and professional use providing flame temperatures up to 1.300°C / 2.340°F.
- > TÜV approved safety features through safety switch (child resistant locking system).
- > Superior grade gas valve for regular and reliable refilling
- > Easy refilling with commonly available lighter gas
- > Long use with large capacity reservoir of 42ml / 1.4oz. (Propane/Butane) providing approx.60 to 70 minutes flame duration.
- > Flexible application hand held or positioned firmly on its stand base.



MT-80

Micro Torch / Rubberized



10080 / Black Rubber Grip / Blister

**PLEASE NOTE :**  
This model is not filled with gas

MT-80

Micro Torch / Alu



10081 / Alu Grip / Blister

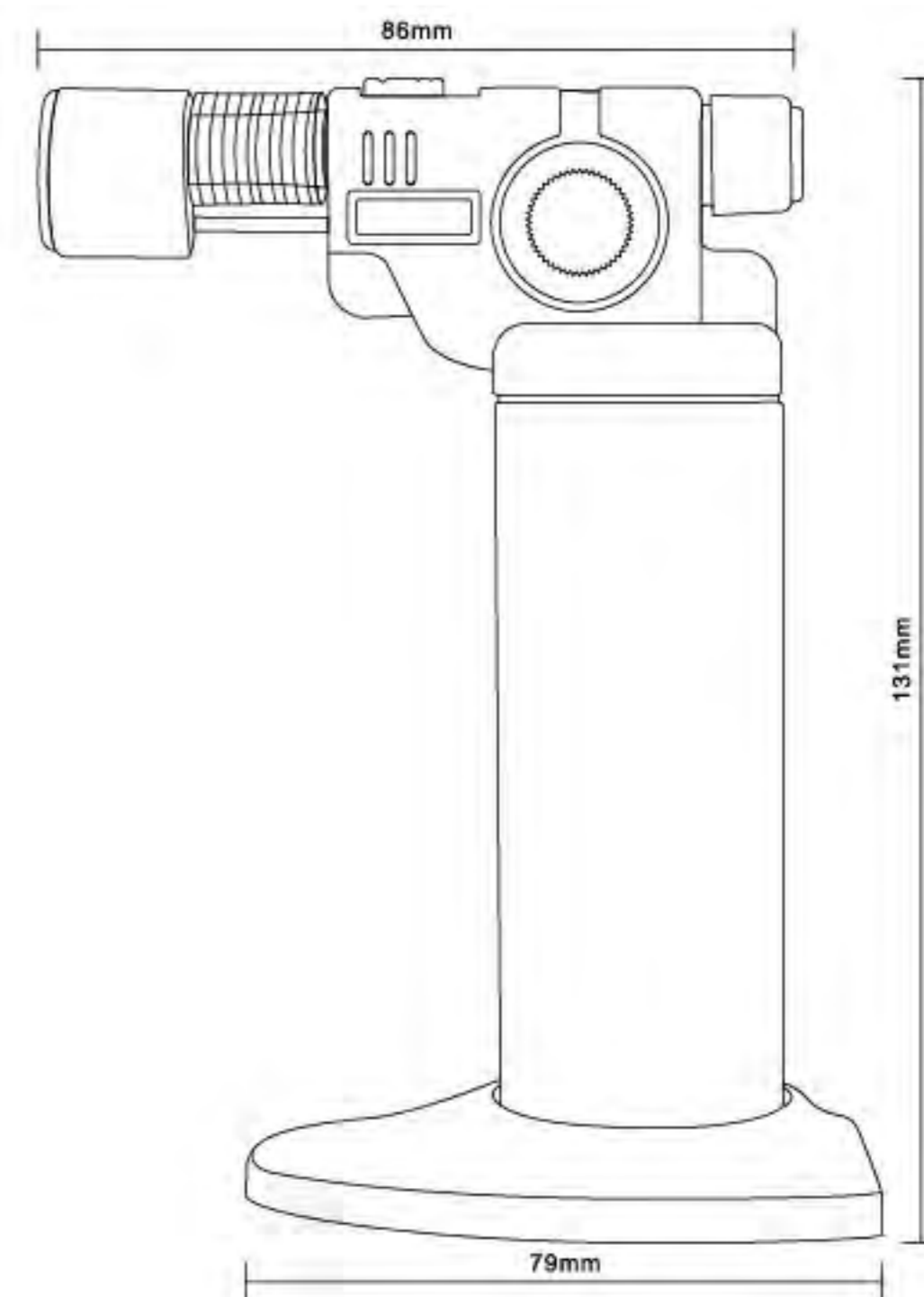

Article Nr.	Blister	Barcode Blister	Innerbox	Barcode Innerbox	Export Carton	Barcode Exp. Cart.	Pallet
10080	1 pcs	4895151829541	12 pcs	4895151829558	48 pcs	4895151829565	960 pcs
10081	1 pcs	4895151830035	12 pcs	4895151830042	48 pcs	4895151830059	960 pcs



Flameclub designs and manufactures a complete selection of exclusively designed lighter products for any lifestyle.

Flameclub offers lighters for the gift, housewares, outdoor, promotional, and tobacco markets.

Flameclub takes pride in providing excellent customer service and absolutely high quality on all our products.

Flameclub invites you to Enjoy Your Best Lighter!

## SOFTFLAME

**SOFTFLAME** or also called regular flame is the most common of all known flame types. It is generated by a piezo or flint wheel ignition. The optimum height of a softflame is approx. 3cm.



## COLORFUL TURBOFLAME

**TURBOFLAME** The windproof burning behaviour is the mark of distinction of turbo flames. Above a nozzle the lighter gas is mixed with air, swirled inside the diffuser and ignited by an electrode. The mixture burns like a Bunsen burner with great heat, but without a visible flame. In general the same technique as used for the classic turbo flame. The only difference is the special magnesium wire that creates the interesting colorful flame.



## JETFLAME

**JETFLAME** is probably the hottest flame available at present. Due to the fact that gas and air are swirled above a nozzle through a special burner type, the sharp and pointed flame is created. And such JETFLAME is normally use for cigars or other professional ways.



To pass the **HEAT TEST** lighters have to withstand 4 hours in a special oven at 65°C. Thereby they may not get any splits or Leaks of gas.



The **DROP TEST** indicates the ability of the lighter to withstand safely a drop from 1.5 m in a group of concrete without splitting.



According to the outside temperature the **FLAME HEIGHT** of lighters varies in use. The maximum flame height may not exceed 10 cm.



A special patented friction wheel allows a child resistant ignition with flint lighters for protecting the safety of user.



**FLAMECLUB** Lighters are produced in TÜV monitored factories. All the production must pass stringent certified and integrated quality management.



A higher pressure on the push button ensures a child-resistant ignition with electronic lighters for protecting the safety of user.





# DESCRIPTION

- GB** Cigarette lighter
- DE** Zigarettenanzünder
- FR** Allume-cigare
- ES** Encendedor
- NL** Aansteker
- IT** Accendisigari
- DK** Cigaret lighter
- PL** Zapalniczka
- PT** Isqueiro
- CZ** Zapalovač
- SE** Cigarettdändare
- RO** Bricheta

- RU** Зажигалка
- UA** Запальничка
- GR** Αναπτήρα
- BG** Запалка
- HU** Öngyújtó
- HR** Upaljač
- TR** Çakmak
- AR** ولاعة السجائر
- JA** シガレットライター
- KO** 라이터
- ZH-CN** 打火机
- ZH-HK** 打火機

All **FLAMECLUB** packs carry the **ISO9994** Norm required warning and safety pictograms clearly printed.



The **ISO9994** is a world-wide valid norm which states the demands within the general product safety for lighters. It consists basically on three test methods (**HEAT TEST, DROP TEST, FLAME HEIGHT**) that a lighter has to pass before being placed on the market. **ISO9994** certification can be provided upon request.



All **FLAMECLUB** Cigarette Lighters sold within the EU are conform with child - resistant standard **EN 13869**.



# PICTOGRAMS

- Flint Lighter
- Piezo Lighter
- Heavy Pusher
- Soft Flame
- Jet Flame
- Turbo Flame
- Gas Refillable
- Disposable
- Registered Patent
- Flame Adjustable
- With Led Light
- With Flash Light
- With Projector Light
- With Led Money Detector
- With Disco Light
- With Bottle Opener
- With Writing Pen

# COLORANNOTATION

- HC** HARD COLOR
- TC** TRANSPARENT COLOR
- ST** TRANSLUCENT COLOR
- MT** MATT COLOR
- MC** METALLIC COLOR
- RC** RUBBERIZED COLOR
- HT** HEAT TRANSFER
- SL** SLEEVE LABEL
- DL** DESIGNER LABEL



## FLINT

## TC Assorted / Chrome Cap



40078H / TC 5 Assorted / EAN Barcode

## FLINT

## TC Colors / 3-Pack



40031H / TC 5 Assorted / 3-Pack Blister

Article nr.	Tray	Barcode Product	Innerbox	Barcode Innerbox	Export Carton	Barcode Exp. Cart.	Pallet
40078H	50 pcs	4895151809567	50 pcs	4895151809574	1.000 pcs	4895151809581	36.000 pcs
Article Nr.	Blister	Barcode Blister	Innerbox	Barcode Innerbox	Export Carton	Barcode Exp. Cart.	Pallet
40031H	3-pack	4895151820623	12 packs	489515182063	96 packs	4895151820647	6.048 packs



## FLINT

## HC Colors / Chrome Cap

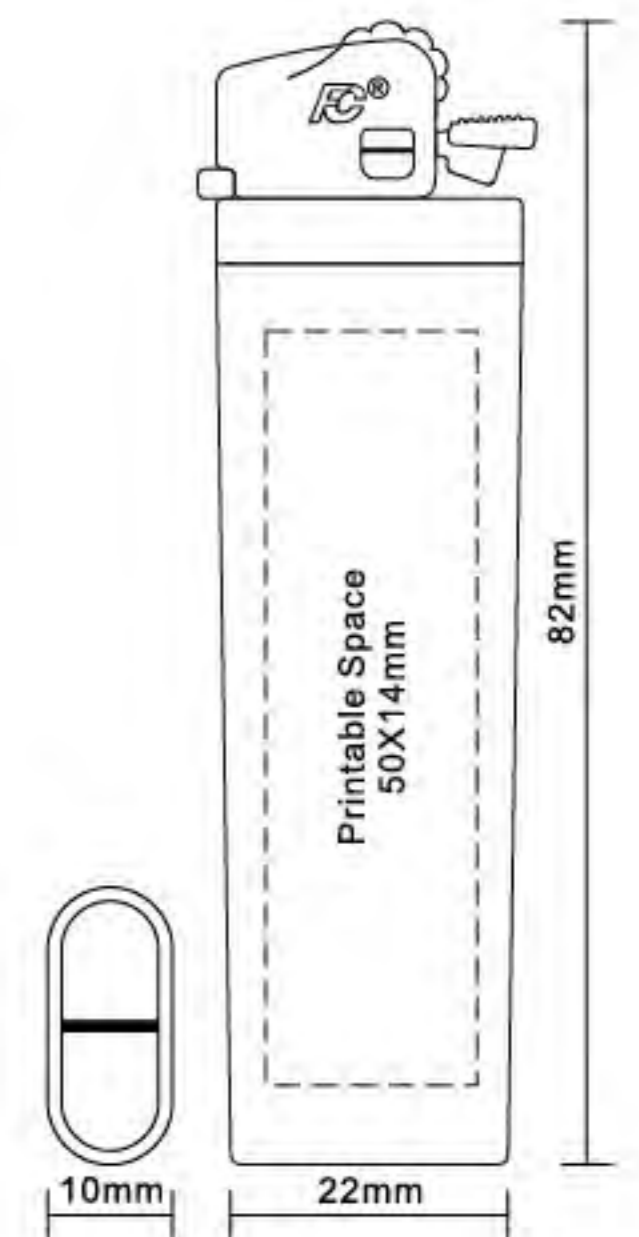

Article nr.	Tray	Barcode Product	Innerbox	Barcode Innerbox	Export Carton	Barcode Exp. Cart.	Pallet
40082H	50 pcs	-	50 pcs	4895151813816	1.000 pcs	4895151813823	36.000 pcs
40083H	50 pcs	-	50 pcs	4895151813830	1.000 pcs	4895151813847	36.000 pcs
40084H	50 pcs	-	50 pcs	4895151813854	1.000 pcs	4895151813861	36.000 pcs
40085H	50 pcs	-	50 pcs	4895151813878	1.000 pcs	4895151813885	36.000 pcs
40086H	50 pcs	-	50 pcs	4895151813892	1.000 pcs	4895151813908	36.000 pcs
40087H	50 pcs	-	50 pcs	4895151813915	1.000 pcs	4895151813922	36.000 pcs
40088H	50 pcs	-	50 pcs	4895151813939	1.000 pcs	4895151813946	36.000 pcs



## FLINT

## HC Colors / Chrome Cap



40091 DL  
White

40092 DL  
Black

40093 DL  
Red

40094 DL  
Yellow

40095 DL  
Blue

40097 DL  
Green

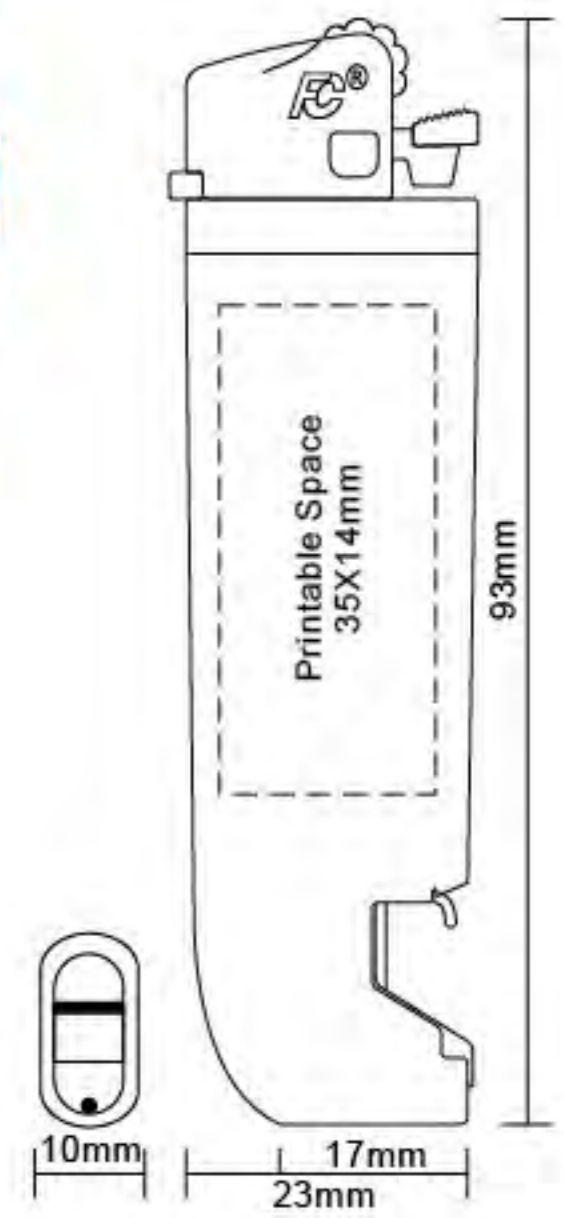

Article nr.	Tray	Barcode Product	Innerbox	Barcode Innerbox	Export Carton	Barcode Exp. Cart.	Pallet
40091 DL	50 pcs	-	50 pcs	4895151815476	800 pcs	4895151815483	28.800 pcs
40092 DL	50 pcs	-	50 pcs	4895151815490	800 pcs	4895151815506	28.800 pcs
40093 DL	50 pcs	-	50 pcs	4895151815513	800 pcs	4895151815520	28.800 pcs
40094 DL	50 pcs	-	50 pcs	4895151815537	800 pcs	4895151815544	28.800 pcs
40095 DL	50 pcs	-	50 pcs	4895151815551	800 pcs	4895151815568	28.800 pcs
40097 DL	50 pcs	-	50 pcs	4895151815599	800 pcs	4895151815605	28.800 pcs



P-01

## UPDATED Bottle Opener / HC Colors



12711  
White

12712  
Black

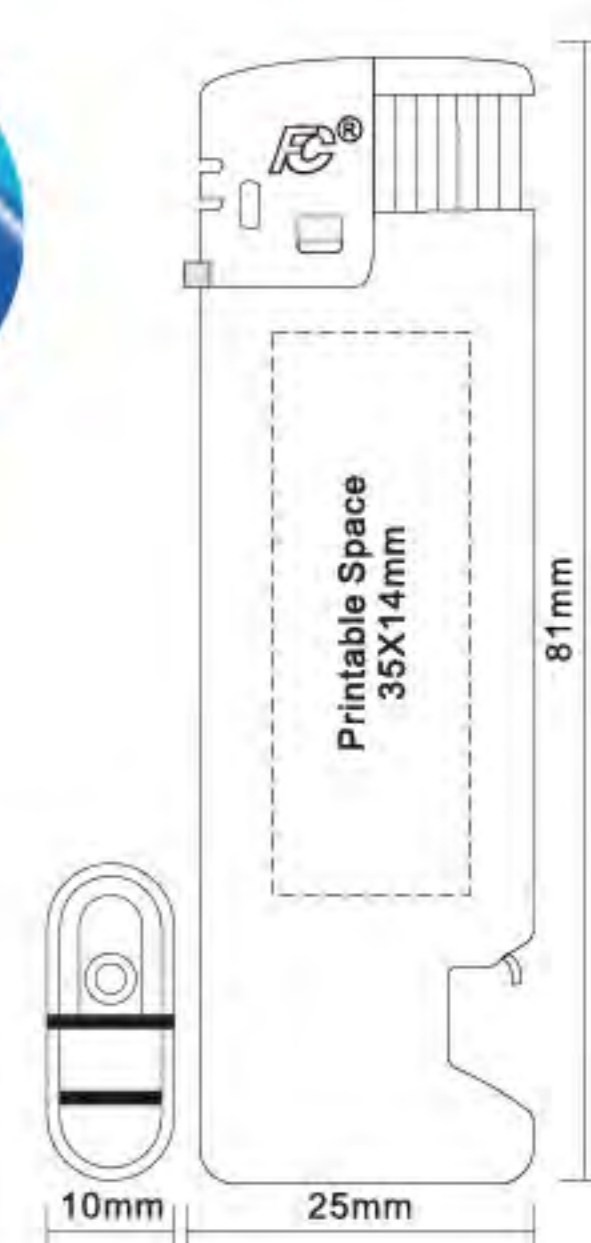

Article nr.	Tray	Barcode Product	Innerbox	Barcode Innerbox	Export Carton	Barcode Exp. Cart.	Pallet
12711 / NEW	50 pcs	-	50 pcs	4895151814592	1.000 pcs	4895151814608	36.000 pcs
12712 / NEW	50 pcs	-	50 pcs	4895151814615	1.000 pcs	4895151814622	36.000 pcs
12703	50 pcs	-	50 pcs	4895151814639	1.000 pcs	4895151814639	36.000 pcs
12704	50 pcs	-	50 pcs	4895151814653	1.000 pcs	4895151814660	36.000 pcs
12705	50 pcs	-	50 pcs	4895151814677	1.000 pcs	4895151814684	36.000 pcs
12706	50 pcs	-	50 pcs	4895151814691	1.000 pcs	4895151814707	36.000 pcs

P-01

## Bottle Opener / HC Colors



12703  
Red

12704  
Yellow

12705  
Blue

12706  
Green

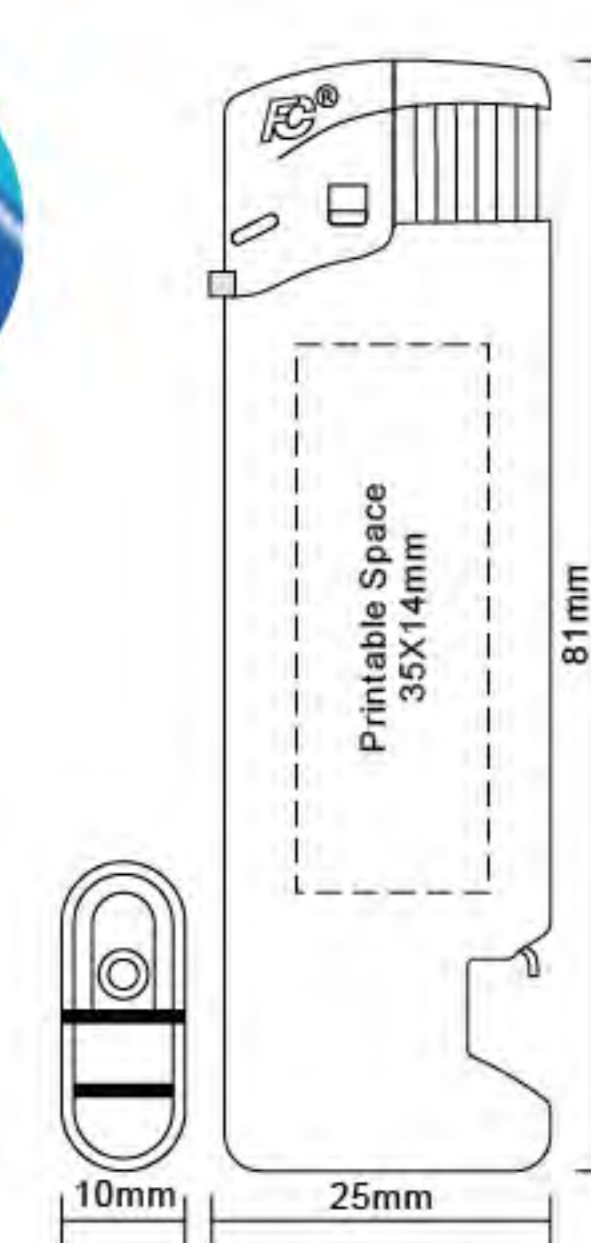



## P-03

### HC Colors / Chrome Cap



50852  
Black

50855  
Blue

50856  
Green

## P-03

### MC Colors / Chrome Cap



50857  
MC Silver

50858  
MC Blue

50859  
MC Gold

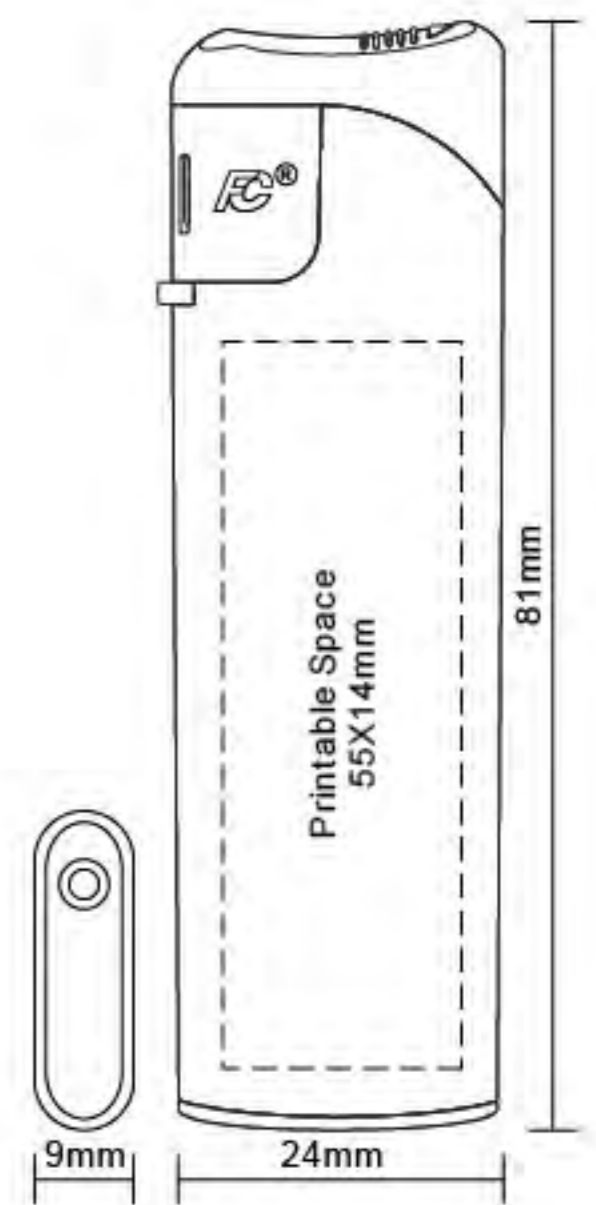

Article nr.	Tray	Barcode Product	Innerbox	Barcode Innerbox	Export Carton	Barcode Exp. Cart.	Pallet
50852	50 pcs	-	50 pcs	4895151814776	1.000 pcs	4895151814783	36.000 pcs
50855	50 pcs	-	50 pcs	4895151814837	1.000 pcs	4895151814844	36.000 pcs
50856	50 pcs	-	50 pcs	4895151814851	1.000 pcs	4895151814868	36.000 pcs
50857	50 pcs	-	50 pcs	4895151814875	1.000 pcs	4895151814882	36.000 pcs
50858	50 pcs	-	50 pcs	4895151814899	1.000 pcs	4895151814905	36.000 pcs
50859	50 pcs	-	50 pcs	4895151829947	1.000 pcs	4895151829954	36.000 pcs



P-04

HC Colors / Chrome Cap



11211  
White

11212  
Black

11213  
Red

Article nr.	Tray	Barcode Product	Innerbox	Barcode Innerbox	Export Carton	Barcode Exp. Cart.	Pallet
11211	50 pcs	-	50 pcs	4895151861619	1.000 pcs	4895151861626	36.000 pcs
11212	50 pcs	-	50 pcs	4895151861633	1.000 pcs	4895151861640	36.000 pcs
11213	50 pcs	-	50 pcs	4895151861657	1.000 pcs	4895151861664	36.000 pcs



P-08

HC Colors / Colored Cap



38980M  
White

38981M  
Black

38983M  
Yellow

38984M  
Blue

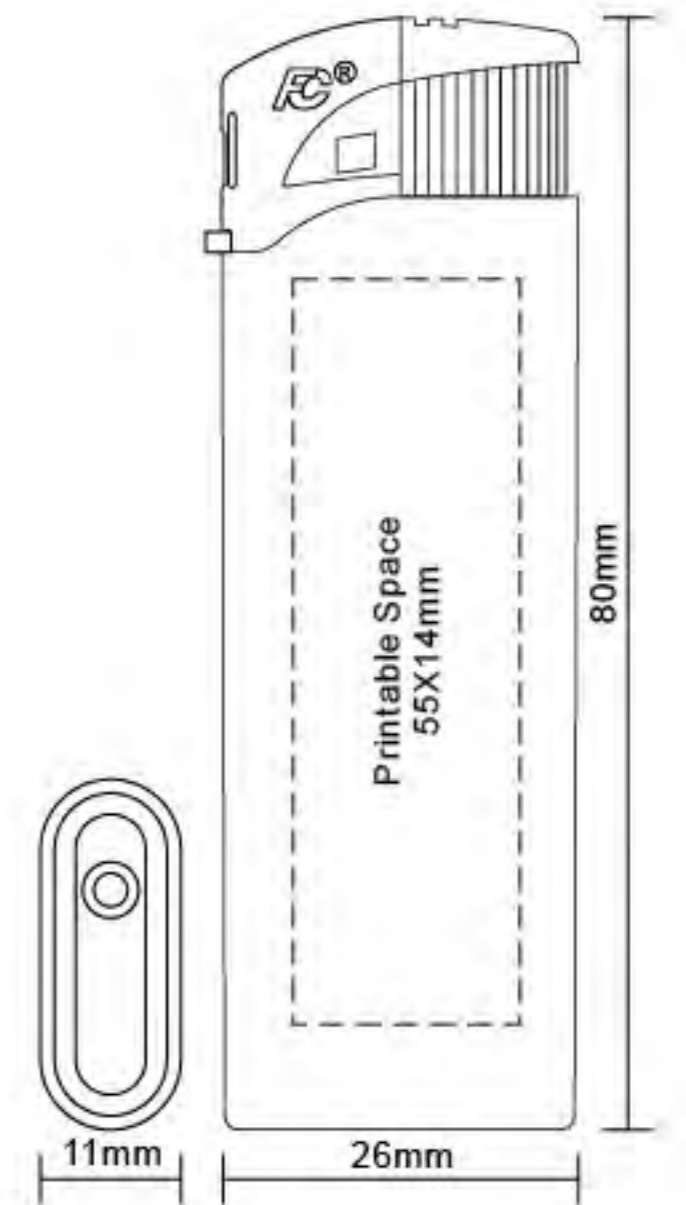

Article nr.	Tray	Barcode Product	Innerbox	Barcode Innerbox	Export Carton	Barcode Exp. Cart.	Pallet
38980M	50 pcs	-	50 pcs	4895151809161	1.000 pcs	4895151809178	36.000 pcs
38981M	50 pcs	-	50 pcs	4895151809673	1.000 pcs	4895151809680	36.000 pcs
38983M	50 pcs	-	50 pcs	4895151809895	1.000 pcs	4895151809901	36.000 pcs
38984M	50 pcs	-	50 pcs	4895151809918	1.000 pcs	4895151809925	36.000 pcs



## P-14 LED

## ST Assorted Colors / Silver Cap

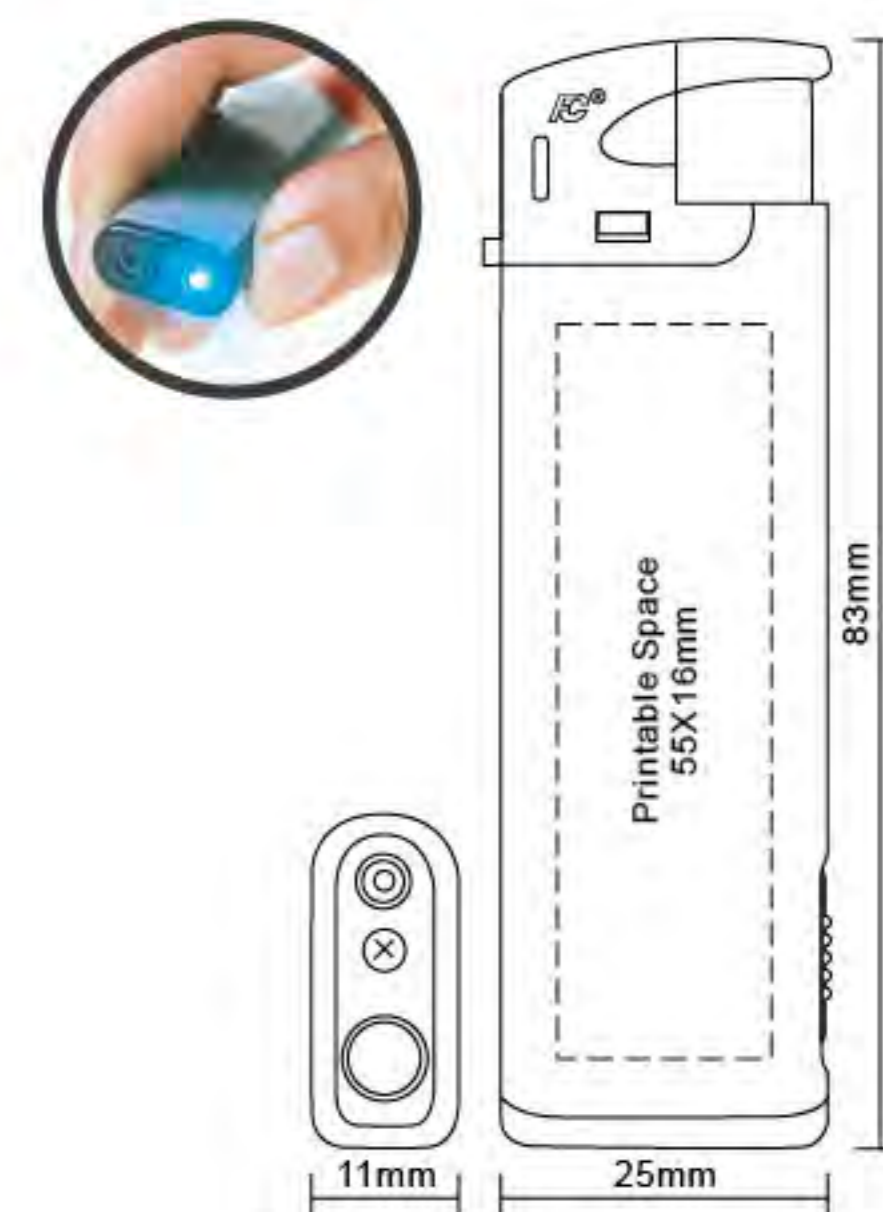

50707  
ST Assorted / EAN Barcode

Article nr.	Tray	Barcode Product	Innerbox	Barcode Innerbox	Export Carton	Barcode Exp. Cart.	Pallet
50760	50 pcs	-	50 pcs	4895151846593	1.000 pcs	4895151846609	36.000 pcs
50761	50 pcs	-	50 pcs	4895151846715	1.000 pcs	4895151846616	36.000 pcs
50762	50 pcs	-	50 pcs	4895151846722	1.000 pcs	4895151846623	36.000 pcs
50764	50 pcs	-	50 pcs	4895151846746	1.000 pcs	4895151846647	36.000 pcs
50765	50 pcs	-	50 pcs	4895151846753	1.000 pcs	4895151846654	36.000 pcs
50769	50 pcs	-	50 pcs	4895151846661	1.000 pcs	4895151846678	36.000 pcs
50707	50 pcs	4895151831025	50 pcs	5895151831032	1.000 pcs	4895151831049	36.000 pcs

## P-14 LED

## HC Colors / Colored Cap



50760 White  
50761 Black  
50762 Red  
50764 Blue  
50765 Green

## P-14 LED

## MC Colors / Silver Cap



50769 Silver



P-16

HC Colors / Colored Cap



71607H  
White

71652H  
Red

71654H  
Green

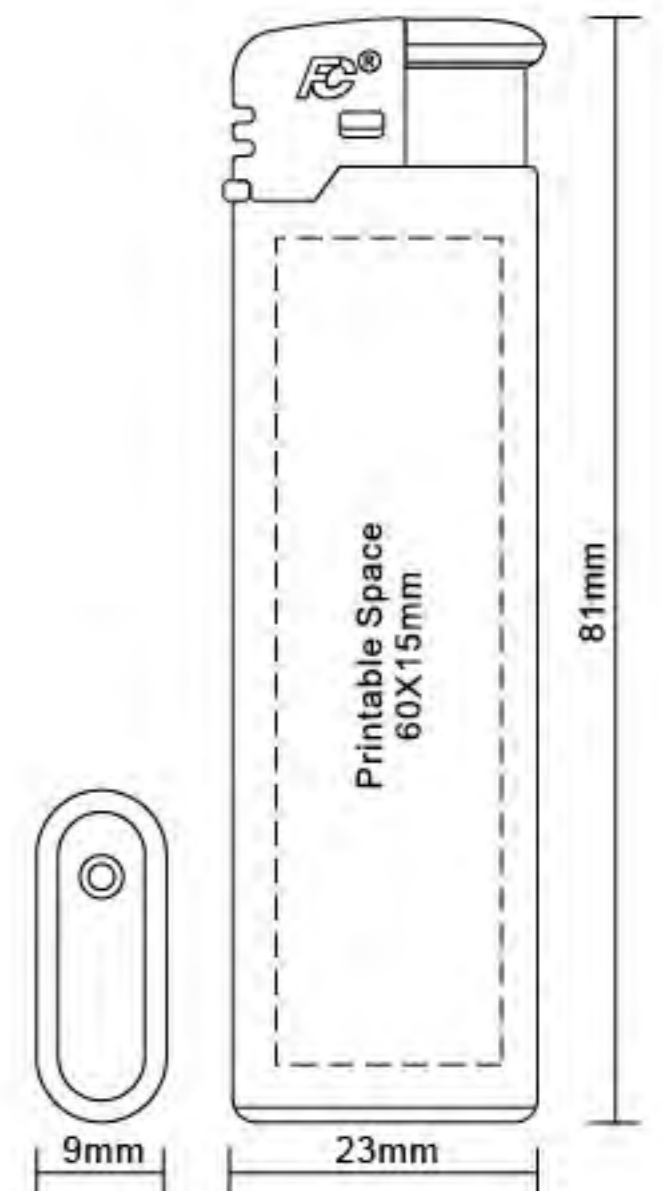

Article nr.	Tray	Barcode Product	Innerbox	Barcode Innerbox	Export Carton	Barcode Exp. Cart.	Pallet
71607H	50 pcs	-	50 pcs	4895151820968	1.000 pcs	4895151820975	36.000 pcs
71652H	50 pcs	-	50 pcs	4895151836846	1.000 pcs	4895151836853	36.000 pcs
71654H	50 pcs	-	50 pcs	4895151836884	1.000 pcs	4895151836891	36.000 pcs
71600H	50 pcs	-	50 pcs	4895151820821	1.000 pcs	4895151820838	36.000 pcs
71601H	50 pcs	-	50 pcs	4895151820845	1.000 pcs	4895151820852	36.000 pcs
71602H	50 pcs	-	50 pcs	4895151820869	1.000 pcs	4895151820876	36.000 pcs
71603H	50 pcs	-	50 pcs	4895151820883	1.000 pcs	4895151820890	36.000 pcs
71604H	50 pcs	-	50 pcs	4895151820906	1.000 pcs	4895151820913	36.000 pcs
71605	50 pcs	-	50 pcs	4895151829920	1.000 pcs	4895151820937	36.000 pcs
71606H	50 pcs	-	50 pcs	4895151820944	1.000 pcs	4895151820951	36.000 pcs

P-16

HC Colors / Black Cap



71600H  
White

71601H  
Black

71602H  
Blue

71603H  
Yellow

71604H  
Red

71605  
Green

71606H  
Orange



## P-16

### ST Colors / Silver Cap



71609H  
Lime

71610H  
Blue

71611H  
Orange

71612H  
White

71613  
Purple

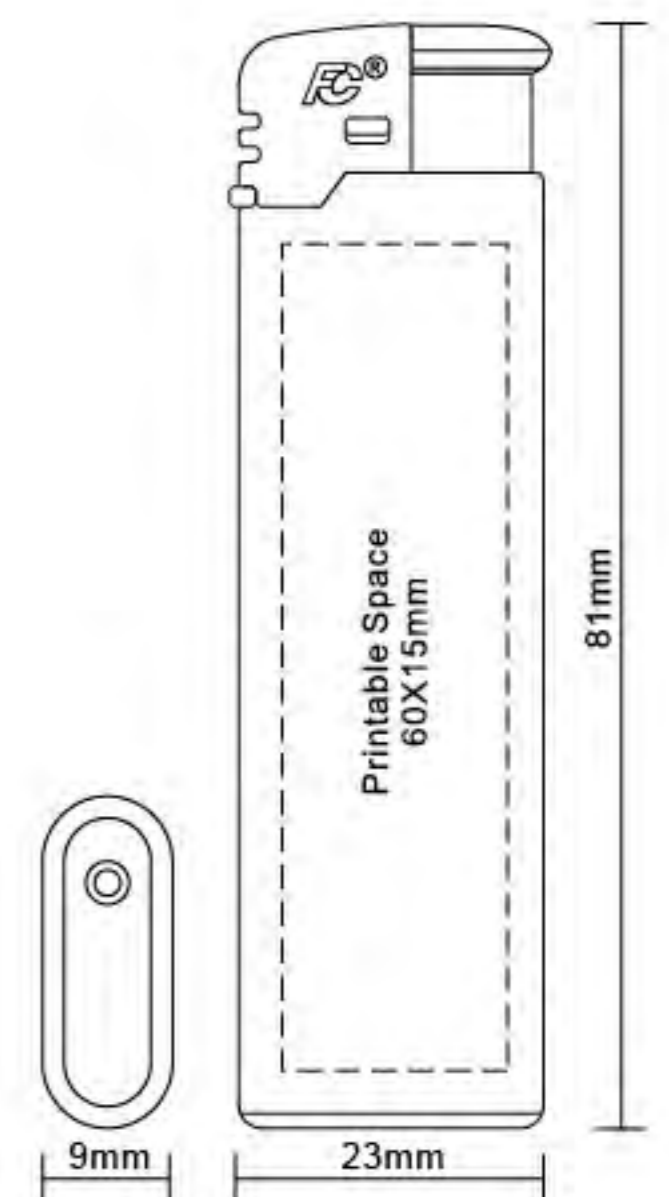

Article nr.	Tray	Barcode Product	Innerbox	Barcode Innerbox	Export Carton	Barcode Exp. Cart.	Pallet
71609H	50 pcs	-	50 pcs	4895151821002	1.000 pcs	4895151821019	36.000 pcs
71610H	50 pcs	-	50 pcs	4895151821026	1.000 pcs.	4895151821033	36.000 pcs
71611H	50 pcs	-	50 pcs	4895151821040	1.000 pcs	4895151821057	36.000 pcs
71612H	50 pcs	-	50 pcs	4895151821064	1.000 pcs	4895151821071	36.000 pcs
71613	50 pcs	-	50 pcs	4895151821088	1.000 pcs	4895151821095	36.000 pcs
71690H	50 pcs	-	50 pcs	4895151843394	1.000 pcs	4895151843400	36.000 pcs

## P-16

### HC Colors / Colored Cap



71690H  
Yellow



P-18

TC Colors / Chrome Cap



17705H / TC 5 Assorted / EAN Label

      							
							
Article nr.	Tray	Barcode Product	Innerbox	Barcode Innerbox	Export Carton	Barcode Exp. Cart.	Pallet
17705H	50 pcs	4895151813007	50 pcs	4895151813014	1.000 pcs	4895151813021	36.000 pcs



P-93

HC Colors / Black Cap



39301  
White

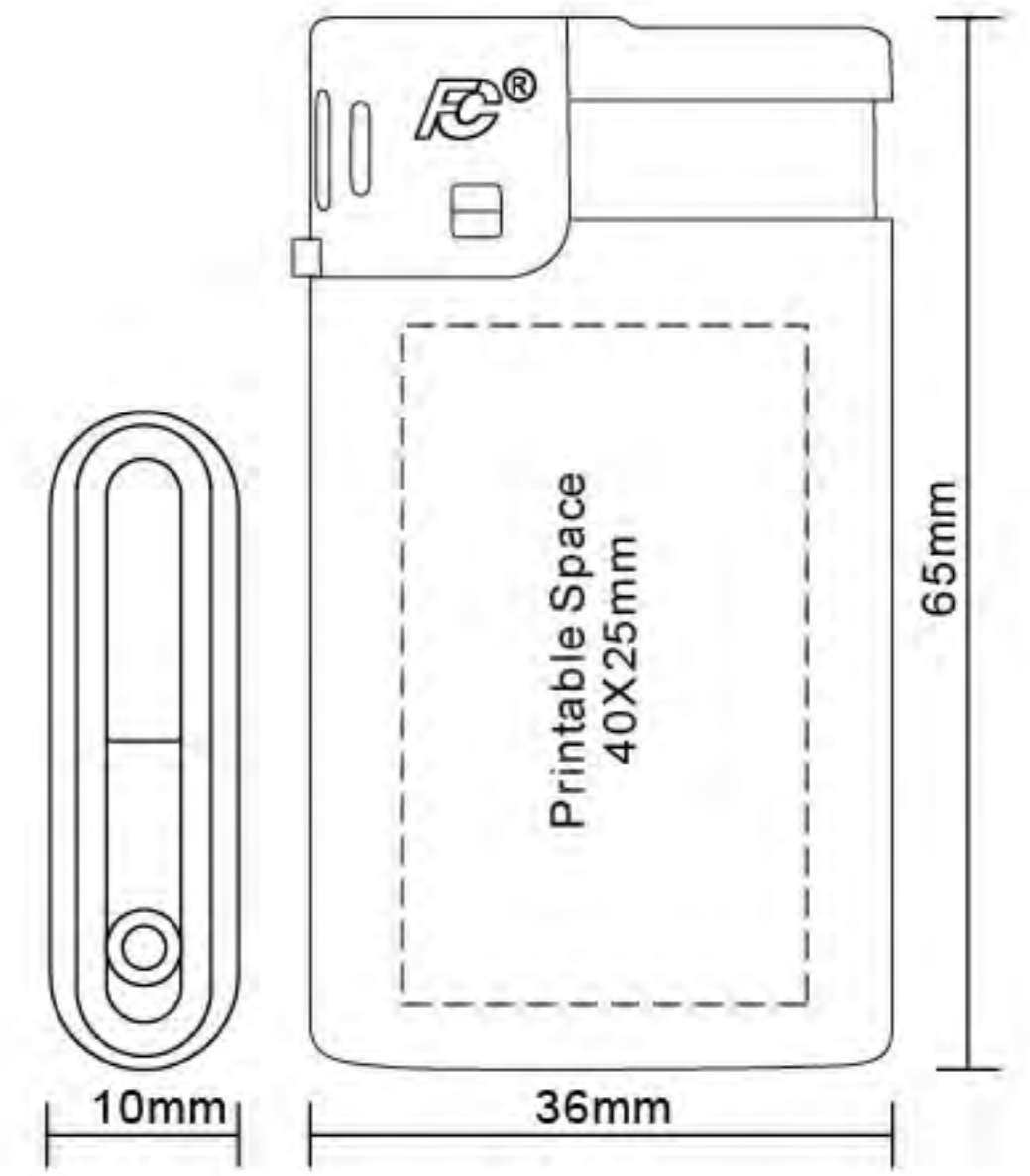

Article nr.	Tray	Barcode Product	Innerbox	Barcode Innerbox	Export Carton	Barcode Exp. Cart.	Pallet
39301	40 pcs	-	40 pcs	4895151830806	800 pcs	4895151830844	28.800 pcs



## FLAMECLUB 360° HIGH DEFINITION DESIGNER LIGHTER

### HOW TO CUSTOMIZE YOUR 360° HIGH DEFINITION DESIGNER LIGHTERS:

For order volumes exceeding 10,000 lighters, we can provide designer service for customized your 360°HD designer lighters.

First, please choose a model of lighter, our designer lighter are available for flint lighters, mostly electronic lighters and part of utility lighters;

Communicate with Flameclub team for the purpose of your designer lighter;

Flameclub designer team will provide several creative designs based on your selected models and purpose;

Make final selection together with our experienced sales to customize your private designer labeled lighters;

You also can provide your own artworks in order to perfectly suit your effective advertising.

All the designer lighters shows in this collection catalogue, is our updated designs based on different models, you also can select one of the design and use it for your favorite models.

A designer lighter gives almost unlimited media attraction and enjoys great popularity. Buying Flameclub designer lighters means buying creative designs.



## 360° HIGH DEFINITION DÉCOR

- Your advertising and creativity appears everywhere!
- Excellent space for advertising.
- Original and eye-catching!
- High stability through scratch-proof label film and optimized adhesive technology
- EAN code included.



P-1823

Deal 2023 / Assorted mixed Designs



Design 1 : Pop / 50 pcs.



Design 2 : Strange / 50 pcs.



Design 3 : Line / 50 pcs.



Design 4 : Tattoo / 50 pcs.



Design 5 : Geometry / 50 pcs.



Design 6 : Sunset / 50 pcs.

6 Designs MIXED  
(6 x 50 lighters)  
Assortment box



Export

Article nr.	Tray	Barcode Product	Innerbox	Barcode Innerbox	Export Carton	Barcode Exp. Cart.	Pallet
18232	50 pcs	4895151854697	50 pcs	4895151854703	300 pcs	4895151854710	30.000 pcs



P-18(23)

TC Assorted / 3-Pack



17724 / TC 5 Assorted / 3-Pack Blister

Article Nr.	Blister	Barcode Blister	Innerbox	Barcode Innerbox	Export Carton	Barcode Exp. Cart.	Pallet
17724	3-pack	4895151836372	12 packs	4895151836389	96 packs	4895151836396	6.048 packs



**T-17 TURBO**

**HC Assorted / Black Top**

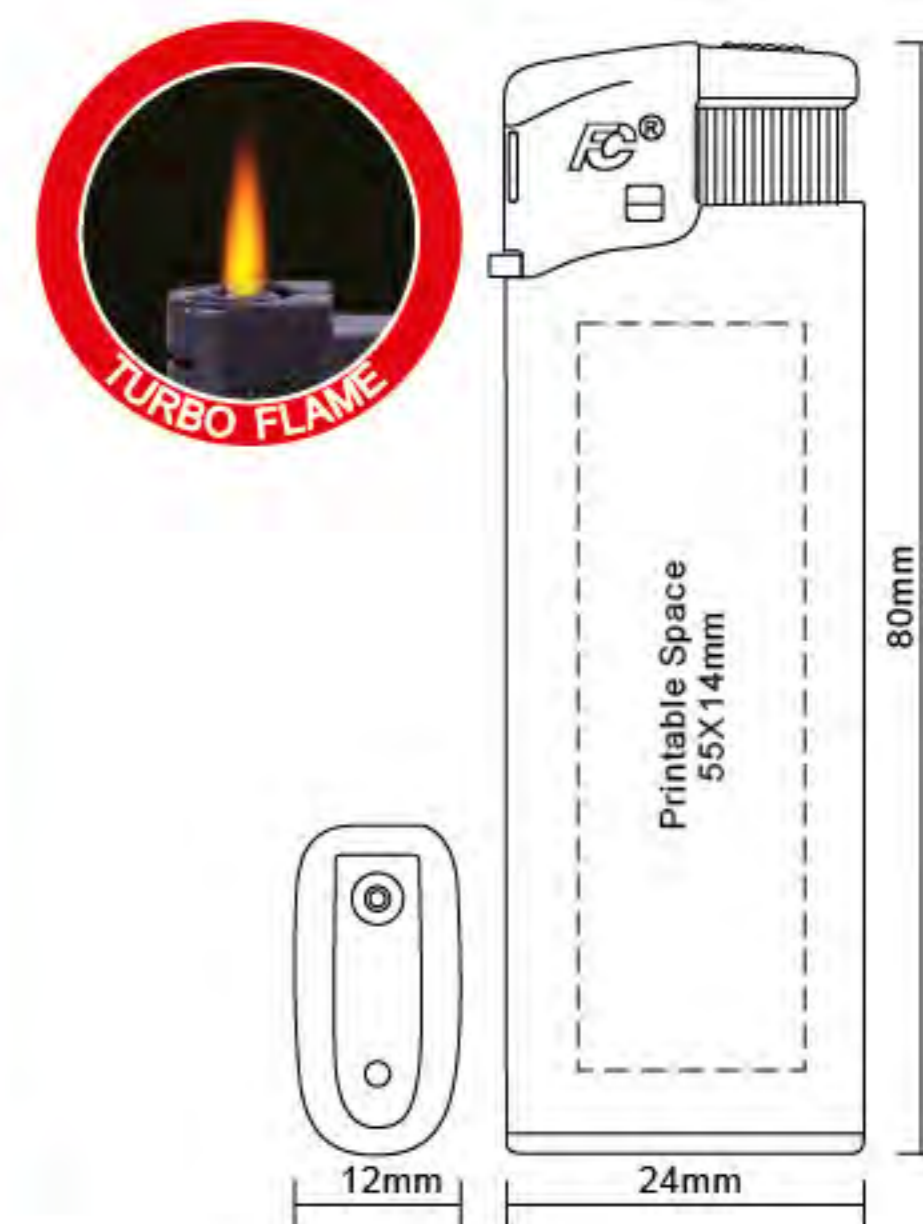

Article nr.	Tray	Barcode Product	Innerbox	Barcode Innerbox	Export Carton	Barcode Exp. Cart.	Pallet
17300	50 pcs	-	50 pcs	4895151853461	1.000 pcs	4895151853478	36.000 pcs
17302	50 pcs	-	50 pcs	4895151853256	1.000 pcs	4895151853263	36.000 pcs
17303	50 pcs	-	50 pcs	4895151853270	1.000 pcs	4895151853287	36.000 pcs
17304	50 pcs	-	50 pcs	4895151853294	1.000 pcs	4895151853300	36.000 pcs
17305	50 pcs	-	50 pcs	4895151853317	1.000 pcs	4895151853324	36.000 pcs
17306	50 pcs	-	50 pcs	4895151853331	1.000 pcs	4895151853348	36.000 pcs
17301	50 pcs	4895151851047	50 pcs	4895151851054	1.000 pcs	4895151851061	36.000 pcs

**T-17 TURBO**

**HC Assorted / Black Top**



17301  
HC Assorted / Black Cap / EAN Barcode



# GAS REFILL MANUFACTURER

## HERSTELLER VON NACHFÜLLGAS

Flameclub is part of a worldwide Flameclub network with its main activities involving manufacturing and distribution of cigarette lighters, smoker's accessories, utility / kitchen lighters and professional burners. Expanding our activities with the production of a fully automatic line of gas refill cans with various capacities, has enabled us to offer our customers a full service assortment for our products.

Offering a wide range of aluminium and steel cans in various capacities and the usage of a high quality gas mixture including isobutane, we can supply our customers with high quality gas refill products for a wide variety of use.

As our range offers also camping gas refill products, we are also offering accessory products for our camping gas line.

Flameclub ist Teil des weltweiten Flameclub Netzwerks mit seinen Hauptaktivitäten in der Herstellung und dem Vertrieb von Feuerzeugen, Raucher-Accessoires, Utility-/Küchen- Feuerzeugen und professionellen Brennern. Die Erweiterung unserer Aktivitäten mit der Produktion einer vollautomatischen Linie von Gas-Nachfülldosen mit verschiedenen Kapazitäten, ermöglicht es uns, unseren Kunden ein Full-Service-Sortiment für unsere Produkte anzubieten.

Mit einer breiten Palette von Aluminium- und Weißblechdosen in verschiedenen Kapazitäten und der Verwendung eines hochwertigen Gasgemisch einschließlich Isobutan, können wir unseren Kunden mit Qualitäts-Nachfüllgas mit einer Fülle an Einsatzmöglichkeiten liefern.

Da wir in unserem Sortiment auch Nachfüllprodukte für Camping-Gas führen, bieten wir darüberhinaus auch noch Zubehör-Produkte für unsere Camping-Gas-Linie.





90 ml

Gas refill

70090 EU / 90 ml.  
High Quality Gas Refill

BUTANE 1057  
90ml [120] e 

INCLUDING:  
Touchable Warning Sign  
"VISUALLY DISABLED"



250 ml

Gas refill

70250 AH / 250 ml  
High Quality Gas Refill

BUTANE 1950  
250ml [321] e 

INCLUDING:  
Touchable Warning Sign  
"VISUALLY DISABLED"



133 ml

Lighter Fluid

70133  
133 ml  
High quality Petrol Fluid Refill

133ml e 

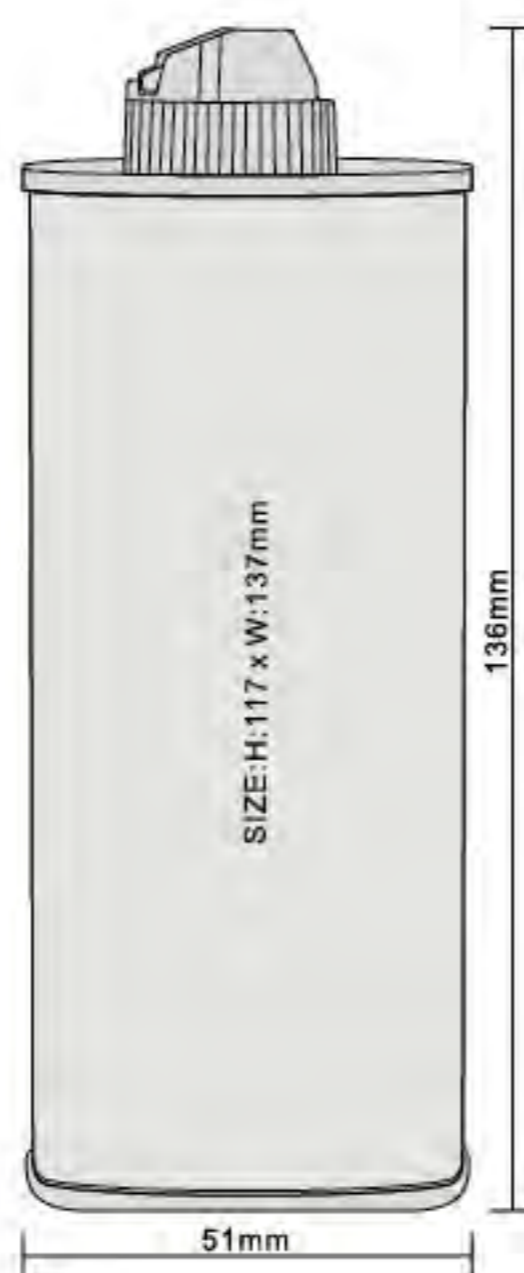

300 ml









Gas refill

70300 / 300 ml  
High Quality Gas Refill

BUTANE 1950  
300ml [405] e 

INCLUDING:  
Touchable Warning Sign  
"VISUALLY DISABLED"

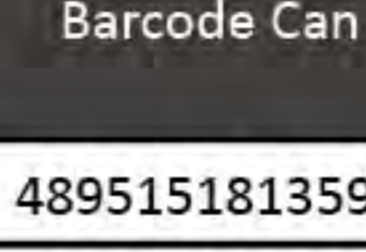

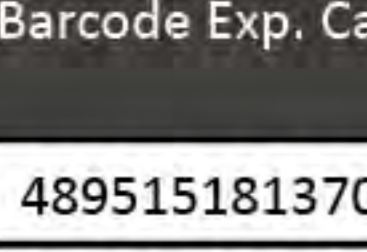
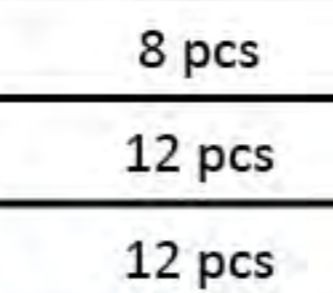
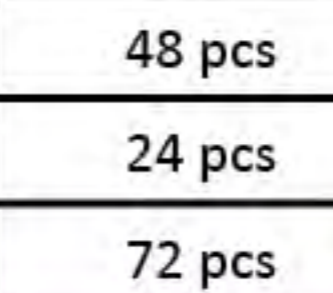
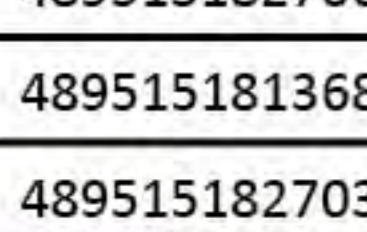
 							
Article Nr.	Display	Barcode Can	Innerbox	Barcode Innerbox	Export Carton	Barcode Exp. Cart.	Pallet
70090 EU	24 pcs						
70250 AH	-			-			-
70300	-			-			-
70133	-	