

100
1919-2019

COLTELLERIA

Utensili da cucina, forbici e casalinghi

Cutlery, scissors, kitchen tools
and houseware



ausonia

www.ausoniatools.com

100
1919-2019

“Cent’anni di Ausonia „
“100 years of Ausonia”



COME LEGGERE IL CATALOGO

How to read the catalogue

linea **CHEF MASTER** CHEF MASTER line
EXPERT COLLECTION

CHEF MASTER

Coltelli professionali

CHEF MASTER professional knives

ART.		lama/blade	Colore manico Handle color
67412	16 cm		
67413	18 cm		
67414	20 cm		
67415	22 cm		
67416	26 cm		
67418	30 cm		

Coltello largo da macellaio
Wide butcher knife

Le dimensioni dei coltelli si riferiscono alla lama e sono espresse in centimetri.
Knives dimensions refer to the blade and are measured in centimeters.

APE line
SCISSORS COLLECTION

FORBICI LAVORO GAMBO MEZZA RANA ANELLO ROVESCIO

Barracuda stainless steel scissors

Forbici con lame microdentate e manici in nylon: soluzioni che sanno riunire qualità e convenienza.
Utility scissors with bent shank and reverse bow.

ART.	dimensioni size
13010	4"
13025	5"

Le forbici vengono misurate in pollici, da chiuse, dalla punta all'estremità dell'impugnatura.
Scissors are measured in inches, from closed, to tip at the end of the handle.



EXPERT COLLECTION

LINEA AVANT / AVANT LINE	
Coltelleria / Cutlery.....	pag 8
Ceppi con coltelli / Block with knives.....	pag 11
LINEA PHOENIX / PHOENIX LINE	
Coltelleria / Cutlery.....	pag 12
LINEA PREMIERE / PREMIERE LINE	
Coltelleria / Cutlery.....	pag 14
LINEA CHEF MASTER / CHEF MASTER LINE	
Coltelleria / Cutlery.....	pag 16
Astucci da cuoco / Chef's set.....	pag 25
Spatole / Spatulas.....	pag 26
Coltelli formaggio / Cheese knives.....	pag 28
Mannarelle professionali / Professional cleavers.....	pag 30



HOME COLLECTION

LINEA ESPERIA / ESPERIA LINE	pag 34
LINEA LEGNO / WOODEN LINE	pag 39
LINEA UNIKO / UNIKO LINE	pag 42
LINEA TAVOLA/BISTECCA / TABLE/STEAK LINE	pag 44
Ceppi e barre magnetiche / Knives blocks and magnetic racks.....	pag 49



TOOLS COLLECTION

Affilatoi / Sharpeners - Expert & home collection.....	pag 52
Forbici da cucina / Kitchen shears.....	pag 54
Forbici, masticatori, schiaccianoci e trinciapolli Kitchen shears, chewer shears, poultry shears and nut crackers.....	pag 55
Utensili e forbici per la preparazione del pesce / Fish kitchen tools line ..	pag 56
Pelapatate e tagliatartufi / Potato peelers and truffle cutter.....	pag 58
Rotelle per pizza, grattugie e fruste Pizza cutters, graters and whisks.....	pag 59
Apriscatole e levanoccioli / Can openers and stoner.....	pag 60
Spada champagne / Champagne sword.....	pag 61
Levatappi / Can openers.....	pag 62
Molle e pale inox per fritto / Inox tongs and frying slices.....	pag 64
Mestoli e cucchiai inox / Inox ladles and spoons.....	pag 65
Utensili vari manico in gomma / Rubber handle tools.....	pag 66
Apriscatole e spazzole / Can openers and wirebrushes.....	pag 68
Batticarne, ganci e pungisalame Meat pounders, hooks and sausage pricker.....	pag 69
Anello segaossa e sega per macellaio Bone saw blades and butcher's saw.....	pag 70
Taglieri / Chopping boards.....	pag 71
Stringiprosciutto / Ham holders.....	pag 72
Forchettoni e spiedini / Forks and skewers.....	pag 73

FORBICI / SCISSORS COLLECTION

LINEA AUSONIA / AUSONIA LINE	pag 76
LINEA APE / APE LINE	pag 80
Espositori da banco Linea Manicure / Linea Casa Manicure line and Home line exhibitors.....	pag 88
LINEA NB / NB LINE	pag 90
Forbici per tessitori e tagliacampioni / Weaver and pinking shears.....	pag 94

ESPOSITORI / DISPLAY	pag 96
-----------------------------------	--------



Cent'anni di Ausonia

Un gesto che continua nel tempo: un successo d'acciaio.

100
1919-2019

Cento anni fa' nasceva Ausonia, la più **antica coltelleria** e utensileria a Maniago, una piccola cittadina friulana conosciuta in tutto il mondo per la produzione e la lavorazione di coltelli ed utensili in acciaio. La registrazione dell'azienda risale nel lontano luglio 1919, e proprio nel 2019 Ausonia ha festeggiato il suo **CENTENARIO**.

La storia di Ausonia, però, ha più di cento anni: infatti, le sue origini artigianali risalgono al Medioevo, quando a Maniago c'era il Conte Nicolò, per poi proseguire alla fine del 1800 con la costituzione, da parte della famiglia Nanutti Beltrame, delle primissime officine attrezzate allo stato primitivo, i cosiddetti battiferri.

Oltre cent'anni di vita hanno permesso all'azienda di costruirsi una "reputazione d'acciaio": infatti, i prodotti Ausonia prevedono un'accurata scelta dei materiali, un impegno alla qualità e una lavorazione che segue i dettami della tradizione alla luce delle tecnologie più attuali.

One hundred years ago Ausonia was born and it is the **most ancient knife factory** in Maniago, a small town in Friuli known all over the world for the production of knives and the manufacturing of steel. Company's registration dates back in July 1919, and in 2019 Ausonia celebrated its **CENTENARY**.

However, Ausonia's history has more than one hundred years: its handcrafted origins date back at the Middle Ages when count Nicolò lived in Maniago, and it goes on at the end of 1800's with the building of many small workshop called battiferro, by the Nanutti Beltrame family. Since Ausonia's foundation, the company has gained "una reputazione di acciaio" (a reputation of steel): indeed, Ausonia products are the result of an accurate choice of the materials, the commitment to quality, and the manufacturing proceeds the tradition according to the latest technologies.



Il battiferro "Nanutti Beltrame" a Maniago, Via dei Fabbri, negli anni 30.
The "Nanutti Beltrame" blacksmith place in Maniago, Via dei Fabbri, in the 30's.



Ausonia oggi

Una reputazione d'acciaio.

Ad oggi, Ausonia vanta un vasto assortimento di oltre 2000 articoli diventando, così, un punto di riferimento per i settori dell'edilizia, della potatura, della coltelleria professionale e da cucina, e per la coltelleria sportiva. Ausonia è storia, tradizione, innovazione ed il suo marchio centenario garantisce ancor oggi per lei.

Today, Ausonia boasts a large stock of more than 2000 items and a wide choice of products in many sector: tools for building and pruning, professional and kitchen cutlery, and sporting knives.

Ausonia is made by history, tradition, innovation and its centenary brand guarantees for itself even now.

L'attuale sede dell'Ausonia a Maniago, storica cittadina italiana del Nord Est.
Ausonia's current offices in Maniago, an historical Italian town of the North East.





LINEA AVANT / AVANT LINE

Coltelleria / Cutlery	8
Ceppi / Block	11

LINEA PHOENIX / PHOENIX LINE

Coltelleria / Cutlery	12
-----------------------	----

LINEA PREMIERE / PREMIERE LINE

Coltelleria / Cutlery	14
-----------------------	----

LINEA CHEF MASTER / CHEF MASTER LINE

Coltelleria / Cutlery	16
Astucci da cuoco / Chef's set	25
Spatole / Spatulas	26
Coltelli formaggio / Cheese knives	28
Mannarelle professionali / Professional cleavers	30

LINEA AVANT

AVANT LINE

ausonia
IL FORGIATO CLASSICO

La serie Forgiata Classica con supporto del manico inforzato offre un'affettatura e un taglio tipicamente professionale.

AUSONIA CLASSIC FORGED KNIFE

The Classic Forged series with reinforced handle support offers a typically professional slicing and

DESIGN A "V" DELLA LAMA
 PRO V-CUT TECHNOLOGY

Perfetta simmetria derivante dal design a "V" dello spessore della lama, realizzato da macchinari di precisione tedeschi. Questa particolare lavorazione garantisce un'affilatura di lunga durata e un'alta resistenza alle macchie.

Symmetrical precision V-shape ground by computerized German Ground machines, which provides long-lasting cutting edge and no stain surface.

RINFORZO / BOLSTER

Il supporto rinforzato del manico offre equilibrio e comfort durante l'uso.
 Angle bolster design provides balance and comfort when use.

PESO BILANCIATO
 BALANCE WEIGHT

La lama a codolo pieno si estende dalla punta del coltello alla fine del manico **BLISTER** per conferire un peso bilanciato.
 Full-tang blade extends from tip of knife to end of handle, lends balance weight.

LAMA IN ACCIAIO TEDESCO DI PRIMA QUALITÀ.

GERMAN STEEL BLADE

Lama in acciaio inossidabile al molibdeno vanadio ad alto tenore di carbonio. Garantisce durata, resistenza alla ruggine e alle macchie.

German 1.4116 High Carbon MoV stainless steel blade ensure durability, rust-resistance, and no stain finish.

MANICO / HANDLE

Impugnatura con tripla rivettatura a codolo pieno. La forma ergonomica dell'impugnatura è progettata per un facilitato controllo della mano, maggiore maneggevolezza e comfort.
 Triple riveted handle design with full tang construction, the ergonomic handle shape is engineered for superior hand control, agility and comfort.



Ogni coltello viene fornito con l'apposito blister.
 Each knife has its own blister.

AVANT - Coltelli professionali

AVANT professional knives

ART.



61158 | 9 cm

Coltello spelucchino
 Peeling knife

61168 | 13 cm

Coltello Costata
 Steak knife

61159 | 15 cm

Coltello da cucina
 Kitchen knife

61165 | 18 cm

Coltello Santoku
 Santoku knife



AVANT - Coltelli professionali

AVANT professional knives

ART.



61162 | 20 cm

Coltello cuoco
Chef's knife



61161 | 22 cm

Coltello da cucina
Kitchen knife



61166 | 23 cm

Coltello pane
Bread knife



61163 | 25 cm

Coltello cuoco
Chef's knife



AVANT - Ceppi

AVANT blocks



ART. 96400
Ceppo in legno di faggio naturale
Natural beech wood block



ART. 96401
Ceppo in legno di tinta ciliegio
Cherry tree style wooden block

ART. 66591
Ceppo vuoto
Empty block

ART.



61158 | 9 cm



61159 | 15 cm



61162 | 20 cm



61161 | 22 cm



61166 | 23 cm

LINEA PHOENIX

Coltelli professionali damascati

PHOENIX LINE - DAMASCUS PROFESSIONAL KNIVES

ausonia

PHOENIX è una linea di coltelli pregiati realizzati in acciaio damascato e in elegante confezione regalo.

The **PHOENIX** series stands out in its beautiful Japanese style hammer finishing on the Damascus patterned blade. Available in a elegant gift box.

DESIGN A "V" DELLA LAMA PRO V-CUT TECHNOLOGY

Perfetta simmetria derivante dal design a "V" dello spessore della lama, realizzato da macchinari di precisione tedeschi. Questa particolare lavorazione garantisce un'affilatura di lunga durata e un'alta resistenza alle macchie.

Symmetrical precision V-shape ground by computerized German Ground machines, which provides long-lasting cutting edge and no stain surface.

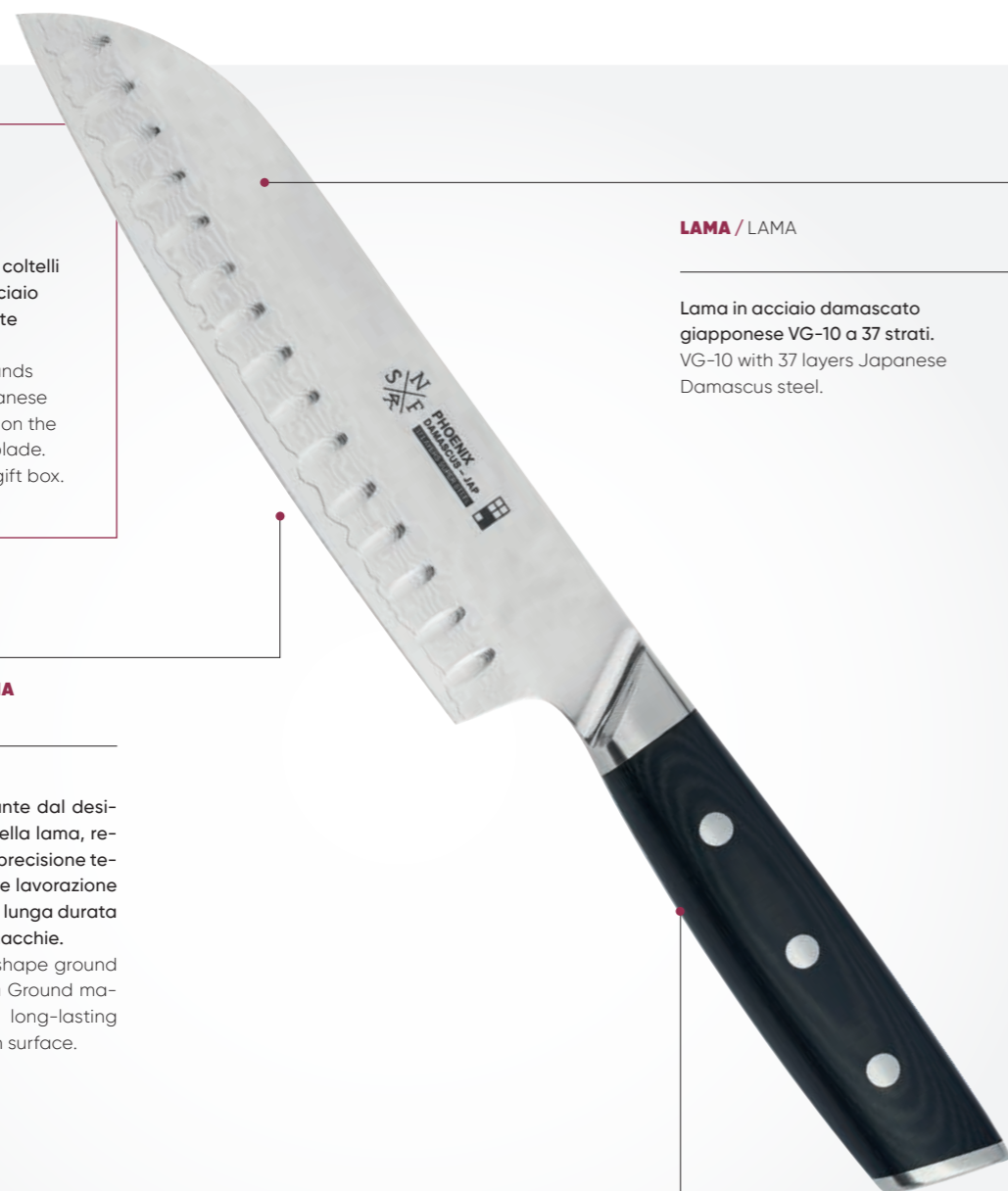

LAMA / LAMA

Lama in acciaio damascato giapponese VG-10 a 37 strati. VG-10 with 37 layers Japanese Damascus steel.

MANICO / MANICO

Manico in elegante micarta con tripla rivettatura a codolo pieno. Triple riveted micarta handle design with full tang construction.

COLTELLI PROFESSIONALI DAMASCATI

Professional **damascus** knives

ART.



lama/blade



62816 | 12 cm

**Coltello multiuso/
bistecca**
Steak knife



62811 | 14 cm

Coltello da cucina
Kitchen knife



62813 | 18 cm

Coltello Santoku
Santoku knife



62812 | 20 cm

Coltello cuoco
Chef's knife



62814 | 23 cm

Coltello pane
Bread knife

LINEA PREMIERE

PREMIERE LINE

ausonia

PREMIERE è una linea di coltelli con manico pieno in acciaio inossidabile. La lama è estremamente affilata e duratura nel tempo. È una linea moderna studiata per un utilizzo giornaliero.

PREMIERE S STEEL is a high quality stainless steel hollow handle knife with extraordinary long-lasting sharpness blade. It is modern and practical for daily use.

PRO V-CUT® TECHNOLOGY

Perfetta simmetria derivante dal design a "V" dello spessore della lama, realizzato da macchinari di precisione tedeschi. Questa particolare lavorazione garantisce un'affilatura di lunga durata e un'alta resistenza alle macchie.

Symmetrical precision V-shape ground by computerized German Ground machines, which provides long-lasting cutting edge and no stain surface.

DESIGN A BORDO PIENO FULL EDGE DESIGN

Bordo tagliente in stile giapponese.
Japanese style, full sharpness cutting edge.

MANICO ASSEMBLATO CON CODOLO PIENO. FULL TANG ASSEMBLED HANDLE.

Il manico in acciaio inossidabile offre massima igiene, maneggevolezza ed un comfort perfetti.
Full stainless steel hollow handle gives comfortable and perfect handling.

LAMA IN ACCIAIO TEDESCO DI PRIMA QUALITÀ. GERMAN STEEL BLADE.

Lama in acciaio inossidabile al molibdeno vanadio ad alto tenore di carbonio. Garantisce durata, resistenza alla ruggine e alle macchie.
German High Carbon stainless steel blade ensure durability, rust-resistance, and no stain finish.



Distribuito e garantito da
Distributed and guaranteed by

ausonia



PREMIERE STEEL
THE TASTE OF
EXCELLENCE
SINCE 1848

PREMIERE - Coltelli professionali

PREMIERE professional knives

ART.



61735 | 15 cm

**Coltello da cucina
inox**
Slicing knife



61733 | 18 cm

**Coltello Santoku
inox**
Santoku knife



61737 | 20 cm

Coltello cucina inox
Kitchen knife



61731 | 20 cm

Coltello pane inox
Bread knife

LINEA CHEF MASTER

CHEF MASTER LINE

ausonia

CHEF MASTER è una serie di coltelli tranciati realizzati in acciaio inox 440A al cromo-molibdeno-vanadio (CR MOV 18) e ad alto contenuto di carbonio (X 60). Per tutti i professionisti della cucina, una garanzia di durata superiore, di rigidità della lama e tenuta del filo, con la comodità del morbido manico in polipropilene/santoprene. L'impiego è reso ancora più pratico e veloce dalla disponibilità di differenti colorazioni dei manici, per l'utilizzo diversificato con alimenti specifici.

The **CHEF MASTER** is a line of sharpened stainless steel knives. (440 chrome vanadium molybdenum high carbon steel). This guarantees long lasting performances and sharp blades. Use is faster and more convenient thanks to the different coloured handles for different kinds of food.









Ogni coltello viene fornito con l'apposito blister.
Each knife has its own blister.

In osservanza alle nuove norme HACCP riguardanti l'igiene alimentare, la linea di coltelleria professionale Chef Master si propone come valido aiuto nella diversificazione dell'utilizzo per ogni coltello prevenendo così i rischi di contaminazione tra diverse categorie di alimenti. Esso viene identificato attraverso un sistema di codifica dei colori che permette di individuare facilmente le diverse aree di lavoro.

In conformity with the new HACCP rules on food hygiene, the Chef Master professional line prevents contamination risks between different food categories. The knife's function is promptly recognized by the colour of the handle that allows a quick identification of the working area.

Colori disponibili: / Colours available:

	Rosso Red	Carni crude Raw meat		Blu Blue	Pesce Raw fish
	Giallo Yellow	Carni bianche White meat		Amaranto Brown	Carni cotte Cooked meat
	Verde Green	Verdure Vegetables		Bianco White	Generico All purpose



Contattare la sede per verificare la disponibilità
Contact Ausonia sales office to check availability



CHEF MASTER Coltelli professionali

CHEF MASTER professional knives

ART.  Colore manico Handle color
lama/blade

67511	7 cm	
67667	7 cm	
67651	7 cm	

Spelucchino curvo
Peeling knife

67512
Conf. espositore 24 pz
24 pcs display box



67638	9 cm
-------	------

Conf. espositore 24 pz
24 pcs display box
Coltello da cucina dentato
Kitchen knife



67514	9 cm
-------	------

Coltello per verdure
Paring knife

67513
Conf. espositore 24 pz
24 pcs display box



67516	10 cm
-------	-------

Coltello per legumi
Paring knife

67517
Conf. espositore 24 pz
24 pcs display box



67449	9 cm	
67450	11 cm	
67661	11 cm	

Spelucchino
Utility knife

67451
Conf. espositore 24 pz
24 pcs display box





CHEF MASTER

Coltelli professionali

CHEF MASTER professional knives



ART.	lame/blade	
67525	11 cm	Coltello Bistecca Steak knife
67526		Conf. espositore 24 pz 24 pcs display box
67522	11 cm	Coltello tavola Table knife
67523		Conf. espositore 24 pz 24 pcs display box
67527	11,5 cm	Coltello costata Steak knife
67528		Conf. espositore 24 pz 24 pcs display box
67518	11 cm	Coltello a tre punte Three pointed knife
67521	12 cm	Coltello per pomodoro Tomato knife
67520	11 cm	Coltello sandwich Sandwich knife

CHEF MASTER

Coltelli professionali

CHEF MASTER professional knives

ART.	lame/blade	Colore manico Handle color
67453	14 cm	●
67454	16 cm	
67448	16 cm	
67455	18 cm	
67456	20 cm	
		Coltello da cucina Kitchen knife
67460	20 cm	●
67461	24 cm	
67462	26 cm	
67464	30 cm	
		Coltello da cuoco Chef's knife
67470	16 cm	●
67459	18 cm	●
67466	22 cm	●
67467	25 cm	
		Coltello per arrosto Slicing knife
67489	45 cm	●



CHEF MASTER Coltelli professionali

CHEF MASTER professional knives

ART.  lama/blade
Colore manico Handle color



67421 14 cm
67423 18 cm
67425 22 cm

Coltello per scannare
Stinking knife



67433 13 cm
67606 13 cm
67619 13 cm
67434 16 cm
67435 18 cm

Coltello per scarnare
Boning knife



67427 16 cm
67605 16 cm
67618 16 cm
67632 16 cm
67676 16 cm
67428 18 cm

Coltello da disosso largo
Wide boning knife



67437 15 cm

Coltello per scarnare flessibile
Flexible boning knife



67438 15 cm

Coltello per scarnare semi rigido
Stiff boning knife

67500 26 cm

Mezzaluna Chef Master con manico atossivo antiscivolo
Chef Master half-moon with hygienic handles

CHEF MASTER Coltelli professionali

CHEF MASTER professional knives

ART.  lama/blade
Colore manico Handle color



67412 16 cm
67413 18 cm
67414 20 cm
67415 22 cm
67416 26 cm
67418 30 cm

Coltello largo da macellaio
Wide butcher knife



67401 16 cm
67402 18 cm
67403 20 cm
67404 22 cm
67602 22 cm
67405 24 cm
67406 26 cm
67603 26 cm
67617 26 cm
67407 28 cm
67409 32 cm
67410 35 cm

Coltello stretto da macellaio
Butcher knife



67488 26 cm

Coltello da pasta
Dough knife



67483 26 cm
67485 34x6 cm
67486 42x6 cm

Coltello da salumi
Salami knife



67481 30 cm

Coltello da salumi dentato
Salami toothed knife



CHEF MASTER

Coltelli professionali

CHEF MASTER professional knives

ART. 
 lama/blade | Colore manico Handle color



67506 16cm-500gr
67507 18cm-550gr
67508 20cm-650gr

Mannaretta
Kitchen cleaver

Spessore lama
Blade thickness
4,0 mm



67504 | 18 cm

Coltello da pesto
Hashing knife



67447 | 28 cm

Coltello da colpo
Heavy knife



67448 | 32 cm

Coltello da mezzo colpo
Heavy knife



CHEF MASTER

Coltelli professionali

CHEF MASTER professional knives

ART. 
 lama/blade



67491 28 cm
67492 30 cm

Coltello stretto da prosciutto
Ham knife



67494 | 30 cm

Coltello stretto da prosciutto super flessibile
Flexible ham knife



67495 26 cm
67497 30 cm

Coltello largo da prosciutto
Wide ham knife



67501 | 30 cm

Coltello stretto da salmone
Indented salmon knife



58090 | 20 cm

Cannula inox per prosciutti con manico atossico
Stainless steel ham boner with hygienic handle



CHEF MASTER

Coltelli professionali

CHEF MASTER professional knives

ART.		Colore
	lama/blade	manico Handle color



67471	20 cm
67472	25 cm

Coltello da pane
Bread knife



67480	25 cm
-------	-------

Coltello lama dentata curva
Wavy edge knife



67473	24 cm
67474	26 cm
67475	28 cm

Coltello lama dentata
Wavy edge knife



67476	30 cm	○
67681	30 cm	
67477	33 cm	
67478	36 cm	

Coltello per pasticceri
Confectioner knife



67479	27 cm
-------	-------

Coltello per surgelati
Frozen food knife



ASTUCCIO PER COLTELLI

CHEF'S SET for knives

97644

Astuccio in tessuto rinforzato da 10 pezzi vuoto
Empty Chef's set for 10 pieces



96254

Astuccio per cuochi pezzi 10 con 9 coltelli Chef Master e 1 affilatoio
10 pieces chef's set with 9 Chef Master knives and 1 sharpener



ART.	
	lama/blade

67530	25 cm
67472	25 cm
67456	20 cm
67492	30 cm
67462	26 cm
67859	26 cm
64402	17 cm
67511	7 cm
67434	16 cm
67450	11 cm



CHEF MASTER Spatole

CHEF MASTER spatulas

ART.



- 64090 | 10 cm
- 64095 | 15 cm
- 64100 | 20 cm
- 64105 | 25 cm
- 64110 | 30 cm
- 64115 | 35 cm

**Spatola per cuoco
diritta**
Straight chef's
spatula



67859 | 26 cm

**Spatola per cuoco
con scalino 4 cm**
4 cm offset blade
chef's spatula



67841 | 16x7,5 cm

**Spatola curva
per fritto**
Curved blade
spatula for fried food



67840 | 26x7,5 cm

**Spatola per fritto
con scalino**
Spatula for fried food
Offset blade



67836 | 10x5,5 cm

**Spatola per dolci
con scalino**
Offset blade cake
spatula



CHEF MASTER Spatole

CHEF MASTER spatulas

ART.



67838 | 12x8 cm

**Spatola per lasagne
con scalino**
Offset blade lasagne
spatula



67837 | 12x9 cm

**Spatola per
pasticcio
con scalino**
Offset blade
lasagne spatula



67839 | 26x7,5 cm

**Spatola per
pasticcio con
scalino**
Offset blade
lasagne spatula



67846 | 10 cm
67848 | 12 cm

Spatola da pizzaiolo
Scraper

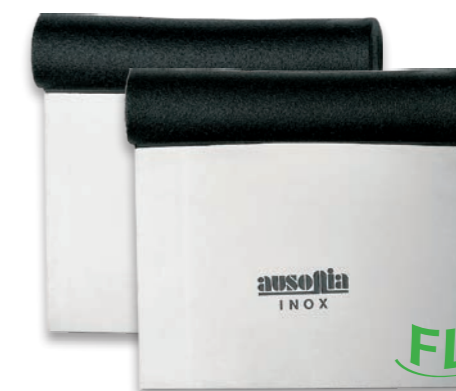

71626 | 11 cm

**Spatola lama inox
rigida con manico
atossico**
Stainless steel stiff
blade spatula
with hygienic handle

71627 | 11 cm

**Spatola lama inox
flessibile con manico
atossico**
Stainless steel flexible
blade spatula with
hygienic handle

FLEX



CHEF MASTER

Linea formaggio

CHEF MASTER cheese line

ART.	lana/blade
	63025 6 cm Coltello da formaggio con manico atossico Cheese knife with hygienic handle
	63035 10 cm 63040 12 cm 63005 13 cm Coltello da formaggio con manico atossico Shaped cheese knife with hygienic handle
	67980 6,5 cm Coltello formaggio con manico atossico, lama in ceramica Parmesan knife ceramic blade
	63032 10 cm Coltello segna formaggio con manico atossico Cheese marker knife with hygienic handle
	63043 16 cm Coltello da formaggio tipo Premana/Lombardia con manico atossico "Premana/Lombardy" shaped cheese knife with hygienic handle
	63022 14 cm Coltello da formaggio a lancia tipo "Milano" con manico atossico Lance "Milano" type cheese knife with wavy edge blade and hygienic handle
	63017 15 cm Coltello da formaggio tipo Vercelli/Piemonte con manico atossico "Vercelli/Piemonte" type cheese knife with hygienic handle
	63060 14x10 cm Coltello da formaggio tipo Veneto a pala con manico atossico "Veneto" type cheese knife with hygienic handle

CHEF MASTER

Linea formaggio

CHEF MASTER cheese line

ART.	lana blade
	63052 15x15 cm 63054 20x20 cm Coltello per formaggio Emmenthal Emmenthal Cheese knife
	63302 24 cm Coltello da formaggio ad archetto a filo inox Cheese inox wire cutter
	67533 22 cm Coltello da formaggio Cheese knife
	63150 36 cm Coltello da formaggio a due mani 2 hands cheese knife
	63203 15 cm Assaggia formaggio Cheese taster



CHEF MASTER

Mannarette e coltello pesce spada

Cleavers and sword fish knife



ART.



lama/blade

64315 20 cm
980 gr

Mannaretta manico plastica
Cleaver with plastic handle

Spessore lama
Blade thickness mm 4,3

64311 21 cm
1200 gr

Mannaretta manico atossico
Cleaver with hygienic handle

Spessore lama
Blade thickness mm 5,0

64318 38 cm
1020 gr

Coltello pesce spada manico plastica
Sword fish knife with plastic handle

Spessore lama
Blade thickness mm 3,0

CHEF MASTER

Mannaie

Butcher cleavers



ART.



lama/blade

64332 23 cm
1400 gr

Mannaia a due mani manico atossico e codolo passante
Butcher cleaver with hygienic handle

Spessore lama
Blade thickness mm 5,0



64330 26 cm
1800 gr

Mannaia da macellaio manico atossico
Butcher cleaver with hygienic handle

Spessore lama
Blade thickness mm 5,3



LINEA ESPERIA / ESPERIA LINE

Coltelleria / Cutlery 34

LINEA LEGNO / WOODEN LINE

Coltelleria / Cutlery 39

LINEA UNIKO / UNIKO LINE

Coltelleria / Cutlery 42

LINEA TAVOLA/BISTECCA TABLE/STEAK LINE

Coltelleria / Cutlery 44

CEPPI E BARRE MAGNETICHE KNIVES BLOCKS AND MAGNETIC RACKS

49

LINEA ESPERIA

ESPERIA LINE

ausonia

Una linea veramente completa di coltelli da cucina dalle grandi prestazioni, con lame in acciaio inox speciale AISI 420 e manico atossico in polipropilene.

Great performance kitchen knives with special AISI 420 stainless steel blades and non-toxic polypropylene handles.

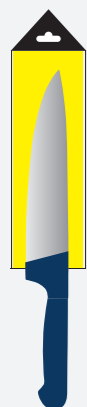

Ogni coltello viene fornito con l'apposito blister.
Each knife has its own blister.



ESPERIA

Coltelli linea casa

HOME COLLECTION knives

ART.



67304 | 7 cm

Spelucchino curvo
Peeling knife

67314

Conf. espositore 24 pz
24 pcs display box



67305 | 9 cm

Coltello per verdure
Paring knife

67316

Conf. espositore 24 pz
24 pcs display box



67288 | 11 cm

Spelucchino
Utility knife

67315

Conf. espositore 24 pz
24 pcs display box



67302 | 11 cm

Coltello bistecca
Steak knife

67312

Conf. espositore 24 pz
24 pcs display box



67301 | 11 cm

Coltello tavola
1/2 seghettato
Half serrated
table knife

67311

Conf. espositore 24 pz
24 pcs display box



ESPERIA

Coltelli linea casa

HOME COLLECTION knives

ART.



67269 | 13 cm
67270 | 16 cm
67272 | 18 cm

Coltello per scarnare
Boning knife



67290 | 16 cm
67291 | 18 cm
67292 | 20 cm

Coltello da cucina
Kitchen knife



67321 | 20 cm
67322 | 24 cm

Coltello da cuoco
Chef's knife



67326 | 18 cm

Coltello Santoku
Santoku knife



67295 | 20 cm
67342 | 25 cm

Coltello da pane
Bread knife



67282 | 28 cm
67307 | 33 cm

Coltello per pasticcere
Confectioner knife



ESPERIA

Coltelli linea casa

HOME COLLECTION knives

ART.



67332 | 26 cm
67334 | 30 cm

Coltello stretto da prosciutto
Ham knife



67336 | 26 cm

Coltello largo da prosciutto
Wide ham knife



67284 | 26 cm

Coltello da salumi
Salami slicing knife



67286 | 26 x 5,5 cm

Coltello da pasta
Dough knife



ESPERIA

Coltelli linea casa

HOME COLLECTION knives

	ART.	lame/blade
	67298	16 cm
	Mannaretta	Kitchen cleaver
	Spessore lama	Blade thickness mm 5,0
	67276 67277	16 cm 18 cm
	Coltello tipo Emilia	"Emilia" type knife
	67267	16 cm
	Coltello per scannare	Stinking knife
	67257 67260	20 cm 25 cm
	Coltello largo da macellaio	Wide butcher knife
	67243 67244 67245 67247 67248 67249 67250 67252	16 cm 18 cm 20 cm 24 cm 26 cm 28 cm 30 cm 34 cm
	Coltello stretto da macellaio	Butcher knife

LINEA LEGNO

WOODEN LINE

ausonia

Nella linea classica con il manico in legno di palissandro, si ritrova tutta la tradizione produttiva Ausonia, accompagnata dall'affidabilità garantita delle lame in acciaio inox speciale AISI 420 al cromo molibdeno vanadio e ad alto contenuto di carbonio.

The classic rosewood wooden line blends together Ausonia's traditional manufacturing together with the reliability given by the special AISI 420 chrome vanadium molybdenum high carbon stainless steel blades.



Ogni coltello viene fornito con l'apposito blister.
Each knife has its own blister.



LINEA LEGNO

Coltelli linea casa

HOME COLLECTION wooden knives

ART.



71260 | 2,5 cm

Taglia castagne
Chestnut knife



62407 | 7 cm

Spelucchino curvo
Peeling knife



62405 | 11 cm

Coltello bistecca
Steak knife



62333 | 11 cm

Coltello da cucina
Kitchen knife



62335 | 12 cm
62343 | 16 cm
62348 | 20 cm

Coltello da cucina
Kitchen knife



62307 | 22 cm

Coltello da arrosto
Slicing knife

62360 | 16 cm
550 gr

Mannaretta
Kitchen cleaver
Spessore lama
mm 4,5
4,5 mm blade
thickness

LINEA LEGNO

Coltelli linea casa

HOME COLLECTION wooden knives

ART.



62290 | 16 cm

Coltello per scarnare
Boning knife



62364 | 20 cm

Coltello da pane
Bread knife



62205 | 18 cm
62215 | 22 cm
62220 | 26 cm

Coltello stretto da macellaio
Butcher knife



62323 | 24 cm

Coltello lama dentata
Wavy edge knife



61170 | 26 cm

Coltello da salumi regolabile
Adjustable salami knife

66600
Guida in plastica ricambio 66600
Spare plastic liner



62313 | 28 cm

Coltello stretto da prosciutto
Ham knife



62270 | 30 cm

Coltello largo da macellaio
Wide butcher knife

LINEA UNIKO

UNIKO LINE

ausonia

Design italiano ed ottimi materiali caratterizzano la nuova linea di coltelleria da cucina UNIKO di Ausonia. Le lame realizzate in acciaio inox AISI 420 garantiscono durata nel tempo ed ottime prestazioni di taglio. I manici realizzati in materiale plastico POM fissati con rivetti in acciaio inox 430 assicurano un aspetto gradevole ed alta resistenza all'usura.

Italian design and fine materials characterize Ausonia's new UNIKO kitchen cutlery line. AISI 420 stainless steel blades guarantee durability and excellent cutting performance. Plastic POM handles fixed with 430 stainless steel rivets provide pleasing appearance and high wear resistance.

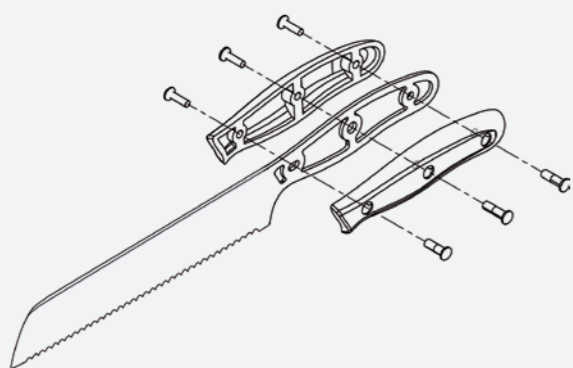

La linea Uniko è interamente progettata da Ausonia.
Uniko line has been completely designed by Ausonia.



Ogni coltello viene fornito con l'apposito blister.
Each knife has its own blister.



UNIKO

Coltelli linea casa

HOME COLLECTION wooden knives

ART.



lama/blade

62601 | 7 cm



Spelucchino curvo manico POM
Peeling knife with POM handle

62660 | 11 cm



Coltello da cucina manico POM
Kitchen knife with POM handle

62654 | 12 cm



Set 4 coltelli bistecca manico POM
4 steak knives set with POM handle

62621 | 16 cm



Coltello da scarnare manico POM
Boning knife with POM handle

62632 | 24 cm



Coltello per arrosto manico POM
Slicing knife with POM handle

62624 | 24 cm



Coltello da pane manico POM
Bread knife with POM handle

62628 | 24 cm



Coltello stretto da prosciutto manico POM
Ham knife with POM handle

LINEA TAVOLA E BISTECCA

TABLE AND STEAK LINE



LINEA TAVOLA E BISTECCA

TABLE AND STEAK line

ART.



61018 | 12 cm

Coltello forgiato da bistecca manico in resina acetlica
Forged steak knife with special resin handle

96551
Confezione regalo 6 coltelli bistecca
Gift box 6 steak knives

61029 | 12 cm

Coltello forgiato da costata manico in resina acetlica
Forged steak knife with special resin handle

96553
Confezione regalo 6 coltelli costata
Gift box 6 steak knives

96521 | 11 cm

Confezione regalo 6 pezzi coltelli bistecca Brio
Gift box with 6 Brio Steak knife



LINEA TAVOLA E BISTECCA

TABLE AND STEAK line

ART.



61530 | 11 cm

**Coltello da tavola
in confezione
espositore 24 pezzi**
Barracuda table
knife - display box 24
pieces



61567 | 11 cm

**Confezione 6 pezzi
coltelli bistecca**
6 steak knives set



61566 | 11 cm

**Confezione 6 pezzi
coltelli tavola**
6 table knives set



61602 | 12 cm

**Confezione 4 pezzi
coltelli tavola
manico rivettato**
Table knife set with
riveted handle



LINEA TAVOLA E BISTECCA

TABLE AND STEAK line

ART.



61652 | 11 cm

**Confezione 6 pezzi
coltelli bistecca
con manico
in plastica nera**
6 steak knives set -
black plastic handle



61651 | 11 cm

**Confezione 6 pezzi
coltelli tavola
con manico
in plastica nera**
6 table knives set -
black plastic handle



61647 | 11 cm

**Confezione 6 pezzi
coltello bistecca
con manico
in plastica bianca**
6 steak knives set -
white plastic handle



61642 | 11 cm

**Confezione 6 pezzi
coltello tavola
con manico
in plastica bianca**
6 table knives set -
white plastic handle



96526

**Set 6 coltelli
bistecca**
6 steak knives set



CEPPI PER COLTELLI

KNIVES BLOCKS

ausonia
CEPPO UNIVERSALE PER COLTELLI

Fessure adatte ad ogni tipo di coltello.
Può contenere: coltelli, forbici, affilatoio
Piastra in acciaio sul fondo per migliorare la stabilità.
Superficie lucida.
Prese d'aria sul fondo.
Smontabile per una facile pulizia.

UNIVERSAL KNIFE BLOCK

Wide and narrow slots for any kinds of knives
Knives, scissors, sharpening rod.
Add-weight stainless steel plate.
Modern mirror-polished surface.
Bottom air vents.
Detachable for easy cleaning.



Adatto a coltelli di spessore 3,50 mm.
Suitable for blade thickness 3,50 mm.



Larghezza lama: ≤ 100 mm
Blade width: ≤ 100 mm

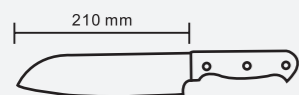

Lunghezza lama: ≤ 210 mm
Blade length: ≤ 210 mm

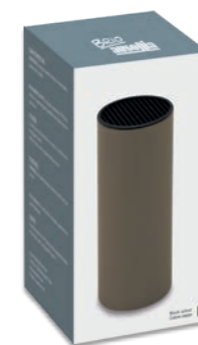

CEPPI E BARRE MAGNETICHE

Knives blocks and magnetic racks

ART. dimensioni
size

66630 L 16,7 cm
P 11 cm
A 24 cm

Ceppo universale per coltelli
Universal knives block

Adatto a coltelli di spessore 3,50 mm.
Larghezza lama: ≤ 100 mm
Lunghezza lama: ≤ 210 mm
Suitable for blade thickness 3,50 mm.
Blade width: ≤ 100 mm
Blade length: ≤ 210 mm

66623 Ø 11 cm
A 22,5 cm

Ceppo universale vuoto grigio tortora
Empty universal block light grey

Adatto a coltelli di spessore 3,50 mm.
Larghezza lama: ≤ 100 mm
Lunghezza lama: ≤ 210 mm
Suitable for blade thickness 3,50 mm.
Blade width: ≤ 100 mm
Blade length: ≤ 210 mm

99179 L 45 cm
P 1,5 cm
A 4,5 cm

Per uso domestico
Domestic use

Barra magnetica universale (ferramenta per montaggio a parete inclusa)
Universal magnetic rack. L 33,5 cm x W 5,0 x H 1,2 cm.
(bolts for wall mounting included)

99178 L 33,5 cm
P 1,2 cm
A 5 cm

Per uso domestico
Domestic use

Barra magnetica universale (ferramenta per montaggio a parete inclusa)
Universal magnetic rack. L 33,5 cm x W 5,0 x H 1,2 cm.
(bolts for wall mounting included)



Affilatoi / Sharpeners - Expert & home collection	52
Forbici da cucina / Kitchen shears	54
Forbici, masticatori, schiaccianoci e trinciapolli / Kitchen shears, chewer shears, poultry shears and nut crackers	55
Utensili e forbici per la preparazione del pesce	
Fish kitchen tools line	56
Pelapatate, tagliatartufi / Potato peelers, truffle cutter	58
Rotelle per pizza, grattugie e fruste	
Pizza cutters, graters and whisks	59
Apriscatole e levanoccioli / Can openers and stoner	60
Spada champagne / Champagne sword	61
Levatappi / Can openers	62
Molle e pale inox per fritto / Inox tongs and frying slices	64
Mestoli e cucchiai inox / Inox ladles and spoons	65
Utensili vari manico in gomma / Rubber handle tools	66
Apriscatole e spazzole / Can openers and wirebrushes	68
Batticarne, ganci e pungisalame	
Meat pounders, hooks and sausage pricker	69
Anello segaossa e sega per macellaio	
Bone saw blades and butcher's saw	70
Taglieri / Chopping boards	71
Stringiprosciutto / Ham holders	72
Forchettoni e spiedini / Forks and skewers	73

AFFILATOI EXPERT collection

EXPERT collection sharpeners





	ART.	lama/blade	
	67530	25 cm	Affilatoio cilindrico professionale con manico atossico Professional cylindrical sharpener with hygienic handle
	72650	20 cm	Affilatoio forgiato manico in resina acetica Forged sharpening steel with special resin handle
	67005	30 cm	Affilatoio ovale professionale con manico atossico Professional oval shape sharpener with hygienic handle
	67010	30 cm	Affilatoio cilindrico professionale con manico atossico Professional cylindrical sharpener with hygienic handle
	72673	20 cm	Affilatoio con manico atossico Sharpener with hygienic handle
	72658 72660	20 cm 25 cm	Affilatoio tradizionale con manico in legno Traditional sharpener with wooden handle



AFFILATOI HOME collection

HOME collection sharpeners

	ART.	dimensioni size	
	72662	19 cm	Affilacoltelli da cucina Sharpener
	72675	19 cm	Affilacoltelli Knife sharpener
	72212		Box 6 affilacoltelli da cucina 6 pieces sharpener display box



FORBICI DA CUCINA

Kitchen shears

ART.	dimensioni size
------	--------------------



71495 | 20 cm

Forbice cucina inox con gambi verniciati e lame dentate modello Extra
Stainless steel kitchen shear with varnished shank and toothed blades Extra model



71501 | 22 cm

Forbice cucina inox
Stainless steel kitchen shear



71498 | 22 cm

Espositore con 12 forbici multiuso da cucina
Multipurpose kitchen scissor display box



71508 | 20 cm

Forbice per erbe aromatiche
Herb scissor



71496 | 24 cm

Forbice Santoku 4 in 1
• Coltello Santoku
• Squamapesce
• Pelapatate
• Apribottiglie
4in1 Santoku scissor
• Santoku knife
• Fish scaler
• Peeler
• Bottle opener



Pratica spazzola pulisci lame in dotazione
Practical cleaning brush included



FORBICI, MASTICATORI, TRINCIAPOLLI E SCHIACCIANOCI

Kitchen shears, chewer shears, poultry shears and nut crackers

ART.	dimensioni size
------	--------------------



72700 | 20 cm

Masticatore curvo nichelato
Nichel plated chewer shears

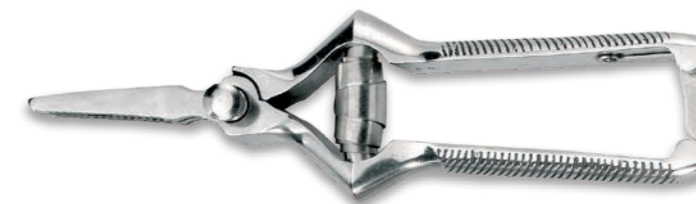

71555 | 18,5 cm

Masticatore curvo inox
Stainless steel chewer shears



31170 | 21 cm

31172 | 23 cm

Forbici inox brevettate per carne cruda
Stainless steel patented shears for raw meat

36003 | 21 cm

36004 | 23 cm

Molla ricambio
Spare spring



71430 | 24 cm

Trinciapollo inox tipo Gazzella
"Gazzella" model stainless steel poultry shear

73100 |

Molla ricambio
Spare spring



71313 | 16 cm

Schiaccianoci inox
Stainless steel nut cracker



71310 | 18,5 cm

Schiaccianoci inox
Stainless steel nut cracker

UTENSILI E FORBICI PER LA PREPARAZIONE DEL PESCE

Fish kitchen tools line

ART.

71251



Forbice inox per ricci di mare con manici in plastica
Stainless steel shear for sea urchins with plastic handles

71252



Forbice inox per ricci di mare
Stainless steel shear for sea urchins

71505



Forbice inox per pesce
Stainless steel fish shears

71650



Coltello squamapesce inox manico atossico
Scale knife with hygienic handle

71622



Pinza inox per pesce
Stainless steel fish tong

UTENSILI E FORBICI PER LA PREPARAZIONE DEL PESCE

Fish kitchen tools line

ART.

71340



Pinza inox per scampi
Stainless steel lobster pick

71254



Stiletto inox per aragosta
Stainless steel lobster pick

71255



Forbice con pinza inox per aragoste e scampi
Stainless steel lobster plier

71239



Apricozze inox con salvadito e manico atossico
Stainless steel lobster plier

71237



Apricozze inox manico atossico
Stainless steel clams opener

71240



Apriostriche inox con salvadito e manico atossico
Stainless steel oyster opener with finger protection and hygienic POM handle

PELATATE E TAGLIATARTUFI

Potato and truffle peelers



71551

Pelapatate inox
Stainless steel potato peeler

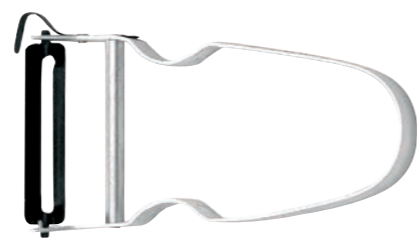

72105

Pelapatate alluminio modello Extra
Aluminium potato peeler Extra model



72112

Pelapatate in ceramica
Ceramic peeler



71056

Pelapatate manico plastica
Potato peeler with plastic handle



71058

Pelapatate manico plastica
Potato peeler with plastic handle



71054

Ausonia - Pelapatate professionale verticale 19 cm con lama inox da 8 cm e manico in legno
19 cm stainless steel professional vertical potato peeler with 8 cm stainless steel blade and wooden handle



71644

Tagliatartufi inox
Stainless steel truffle



ROTELLE PER PIZZA, GRATTUGIE E FRUSTA

Pizza cutters, graters and whisk



77131

Rotella per pizza inox
Stainless steel pizza cutter

Ø 10 cm



71796

Espositore con 6 rotelle per pizza
6 pizza cutters display box



71630

Grattugia inox foro piccolo
Stainless steel grater with small hole



71631

Grattugia inox foro grande
Stainless steel grater with big hole



71635

Grattugia inox con raccogliore
Stainless steel grater with basin

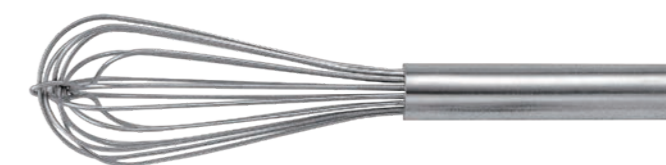

71538

25 cm

71540

30 cm

71541

35 cm

71542

40 cm

71543

45 cm

71544

50 cm

Frusta in filo inox
Stainless steel whisk

APRISCATOLE E LEVANOCCIOLI

Can openers and stoner

ART.

71043



Apriscatole inox a pinza

Stainless steel can opener plier style

71015



Apriscatole inox manico legno

Stainless steel can opener with wooden handle

Fino ad esaurimento scorte - while stock last

72018



Apriscatole con manico in gomma antiscivolo

Can opener with anti-slip rubber handle

72708



Levanoccioli in alluminio

Aluminium stoner

SPADA DA CHAMPAGNE

Champagne sword

ART.

dimensioni
size

61335

34 cm

Spada da champagne con manico in legno d'olivo
Champagne sword with olive tree handle



Una splendida lama in acciaio inox AISI 420 MA4 temperato con il manico in legno d'olivo. Completa questa scenografia esclusiva una bottiglia di pregiato Prosecco di Valdobbiadene DOCG da stappare nei momenti più importanti. Un dono che saprà di certo farsi ricordare.

A beautiful AISI 420 MA4 stainless steel sharpened blade with olive tree handle. It comes together with a bottle of fine Prosecco DOCG wine from Valdobbiadene to uncork on special occasions. A gift that will certainly be remembered.



LEVATAPPI

Can openers



Leva a cursore
Ratchet opening system



ART.

72346

Levatappi cameriere "spanner" con manico atossico tagliacapsule e apertura a cricchetto brevettate che riduce del 50% la fatica di estrazione del tappo
Waiter's knife spanner" with hygienic handle patented capsula cutter and patented ratchet opening system



72340

Levatappi cameriere con manico atossico
Waiter's knife with hygienic handle



Leva a cursore
Ratchet opening system

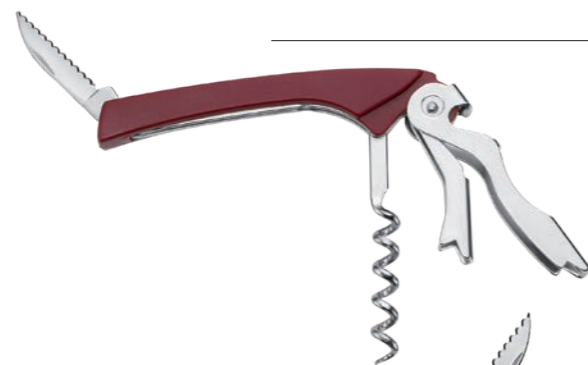

72339

Levatappi nichelato con manico atossico
Nichel plated waiter's knife with hygienic handle

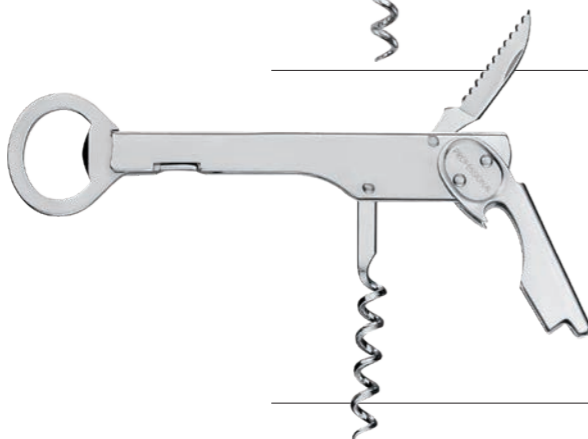

72354

Levatappi cameriere nichelato
Nichel plated waiter's knife



72370

Pinza nichelata per tappi Champagne
Champagne nichel plated plier

LEVATAPPI E TAPPO VERSATORE

Can openers and plier



ART.

72322

Levatappi a leva verniciato tipo Cantinello
"Cantinello" style varnished cork screw

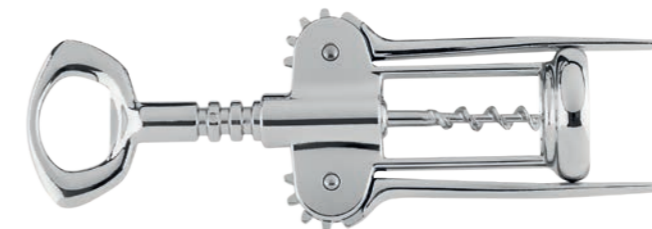

72305

Levatappi a leva
Cork screw



72326

Espositore con 6 levatappi 4in1
*Lama per tagliare la capsula della bottiglia
*Manopola girevole a cricchetto
*Spirale autoflettante
*Tappo di silicone
6 4in1 wine tool display box
*Foil cutter
*Ratcheting turning knob
*Opener
*Silicone stopper



72376

Tappo versatore vino brevettato
Patented wine pouring cap

LINEA CUCINA INOX

Molle e pale per fritto

INOX KITCHEN LINE - Tongs and frying slices

ART.	dimensioni size
71560	
Molla inox per affettati Stainless steel tongs for sliced salami	
71610	
Molla inox per dolci Stainless steel tongs for pastry	
71605	
Molla inox per spaghetti Stainless steel tongs for spaghetti	
71616	
Molla inox per arrosto Stainless steel tongs for roast	
71566	30 cm
Molla da cucina inox Stainless steel kitchen tongs	
71691	
Pala fritto inox 18/C pesante con fori 18/C heavy stainless steel frying slice with holes	
71692	
Pala fritto inox 18/C pesante senza fori 18/C heavy stainless steel frying slice without holes	

LINEA CUCINA INOX

Mestoli e cucchiai

INOX KITCHEN LINE - Ladles and spoons

ART.	dimensioni size
71674 71677 71678	6 cm 9 cm 10 cm
Mestolo inox 18/C pesante 18/C heavy stainless steel ladle	
71697 71698	11 cm 13 cm
Schiumarola inox 18/C pesante 18/C heavy stainless steel skimmer	
71701	
Cucchiaione inox 18/C pesante 18/C heavy stainless steel serving spoon	
71699	
Forchettone inox 18/C pesante 18/C heavy stainless steel fork	
71703	30 cm
Cucchiaio servire riso inox 18/C pesante 18/C heavy stainless steel rice spoon	
71684	
Mestolo spaghetti inox 18/C pesante 18/C heavy stainless steel spaghetti ladle	

LINEA CUCINA IN GOMMA

Utensili vari

KITCHEN LINE rubber handle tools

ART.



71786

Levacapsule con forascatole inox e manico in gomma antiscivolo
Stainless steel bottle opener with can puncher and anti-slip rubber handle



71789

Pelapatate inox oscillante con manico in gomma antiscivolo
Stainless steel swivelling potato peeler with anti-slip rubber handle



71792

Scavino inox con manico in gomma antiscivolo
Stainless steel melon baller with anti-slip rubber handle



71785

Coltello formaggio inox con manico in gomma antiscivolo lama 13 cm
Stainless steel cheese knife with anti-slip rubber handle 13 cm blade



71711

Spremiaglio inox con manico in gomma antiscivolo
Stainless steel garlic press with anti-slip rubber handle

LINEA CUCINA IN GOMMA

Utensili vari

KITCHEN LINE rubber handle tools

ART.



72695

Spatola dolci in silicone con manico in gomma antiscivolo
Silicone kitchen spatula with anti-slip rubber handle



71787

Paletta dolce inox con manico in gomma antiscivolo
Stainless steel pie server with anti-slip rubber handle



71706

Forchettone inox con manico in gomma antiscivolo
Stainless steel fork with anti-slip rubber handle



71172

Scavino doppio inox
Stainless steel double melon baller

APRISCATOLE E SPAZZOLE

Can openers and wirebrushes

ART.

72005

Apriscatole professionale con manico legno
Professional wooden handle can opener



72007

Apriscatole professionale da banco
Professional can opener

71007

Apriscatole professionale INOX da banco
Stainless steel professional can opener

Ricambi:
Spare parts:

73610	Lama - Blade
73611	Ingranaggio - Gear
73612	Staffa - Bracket
73613	Portalamo - Blade holder



57100 | 27 cm
Spazzola con filo in acciaio ottonato
Wirebrush with brass steel wire



57101 | 39 cm
Spazzola con filo in acciaio ottonato
Wirebrush with brass steel wire



57105 | 27 cm
Spazzola con filo in acciaio inox
Wirebrush with stainless steel wire

BATTICARNE, GANCI E PUNGISALAME

Meat pounders, hooks and sausage pricker



71516 | 500 gr
Batticarne inox manico plastica
Stainless steel meat pounder with plastic holes



71520 | 800 gr
Batticarne inox tipo famiglia
House stainless steel meat pounder



71510 | 1600 gr
Batticarne inox tipo gigante
Large stainless steel meat pounder



58299 | 60x3 mm
58300 | 80x4 mm
58302 | 100x4 mm
58305 | 120x5 mm
58307 | 140x6 mm
58310 | 160x6 mm
58315 | 6180x8 mm
58320 | 220x10 mm
Gancio inox per macellaio
Stainless steel s-shaped hook



58365 | 160x6 mm
Gancio inox con anello
Stainless steel hook with ring



58325 | 120x6 mm
58330 | 130x7 mm
Gancio inox ad ancora
Double stainless steel hook



58340 | 210x9 mm
58345 | 240x10 mm
58350 | 270x12 mm
58355 | 1500x12 mm
Gancio inox snodabile
Stainless steel turnable hook



58455 | 27 cm
Pungisalame manico atossico
Sausage pricker with hygienic handle

ANELLO SEGAOSSA E SEGA PER MACELLAIO

Bone saw blades and butcher's saw

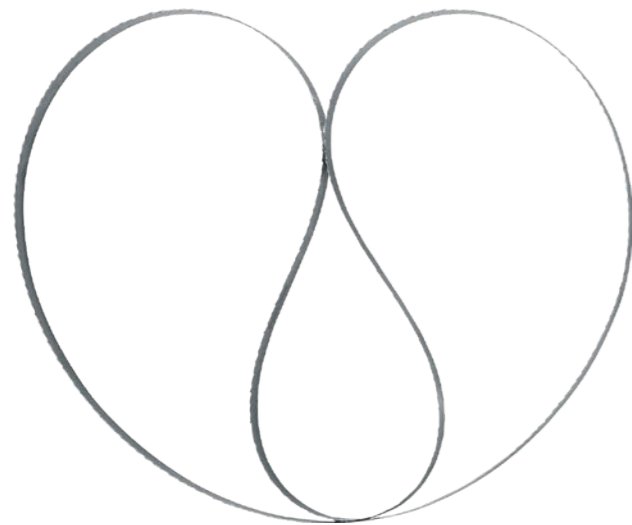

ART.	dimensioni size
58005	1490 mm
58010	1510 mm
58015	1550 mm
58020	1580 mm
58025	1600 mm
58027	1650 mm
58030	1700 mm
58032	1760 mm
58035	1800 mm
58038	1840 mm
58040	1890 mm

Anello segaossa
Bone saw blades



58050	40 cm
58055	45 cm
58060	50 cm

Sega per macellaio
Butcher's saw

58064	40 cm
58065	45 cm
58066	50 cm

**Sega per macellaio
modello inox**
Butcher's inox saw

Lame ricambio inox
Stainless steel spare blades

58404	40 cm
58405	45 cm
58410	50 cm

TAGLIERI

Chopping boards



ART.	dimensioni size
66421	22x15x1 cm
66422	30x20x1 cm

Tagliere in polietilene bianco
White polyethylene chopping board

66401	40x30x2 cm
66406	50x30x2 cm
66411	60x40x2 cm
66416	70x40x2 cm

Tagliere in polietilene bianco
White polyethylene chopping board



66405	40x30x2 cm
66410	50x30x2 cm
66415	60x40x2 cm
66420	70x40x2 cm

Tagliere in polietilene rosso
Red polyethylene chopping board

66404	40x30x2 cm
66409	50x30x2 cm
66414	60x40x2 cm
66419	70x40x2 cm

Tagliere in polietilene blu
Blue polyethylene chopping board



66440	40x25x4 cm
66441	50x35x4 cm

Tagliere in legno
Wooden chopping board

STRINGIPROSCIUTTO

Ham holder

ART.



68301

Stringiprosciutto professionale con base in legno
Professional ham holder with wooden basement

68305

Morsa portaprosciutto con base in legno di pino
Ham holder with base in pine wood



68303

Stringiprosciutto
Ham holder



FORCHETTONI E SPIEDINI

Forks and skewers

ART.

dimensioni
size



64402

17 cm

Forchettone forgiato
Forged fork



64410

28 cm

Forchettone forgiato con manico in legno
Forged fork with wooden handle

64407

57 cm

Forchettone forgiato con manico in legno
Forged fork with wooden handle



58530

53 cm

Set 4 spiedini inox con pratica placchetta scorrevole per spingere il cibo.
Stainless steel skewer 4 pieces set with practical sliding clip to push food off the skewer.



Con pratica placchetta scorrevole per spingere il cibo.
With practical sliding clip to push food off the skewer.

58500

200x3 mm

58510

250x3 mm

58520

300x3 mm

Cartella con 6 spiedini inox
Card with 6 stainless steel skewers



Forbici
SCISSORS COLLECTION

LINEA AUSONIA / AUSONIA LINE 76

LINEA APE / APE LINE 80

Espositori da banco Linea Manicure / Linea Casa
Manicure line and Home line exhibitors 88

LINEA NB / NB LINE 90

Forbici per tessitori e tagliacampioni
Weaver and pinking shears 94

ESPOSITORI / DISPLAY 96

FORBICI LINEA AUSONIA

AUSONIA SCISSORS LINE



ausonia line



Ogni forbice viene fornita con l'apposito blister. Each knife has its own blister.



ART. 11994

Espositore da banco 18 forbici AUSONIA Sette Stelle
Display box with 18 AUSONIA Sette Stelle stainless steel multipurpose scissors

ART. 11943 - 6 pz.

ART. 11944 - 6 pz.

ART. 11946 - 6 pz.

FORBICI PROFESSIONALI INOX LINEA SETTE STELLE

Sette Stelle stainless steel professional scissors

Linea di forbici di alta qualità, garantita da lame in acciaio inox X50CrMoV15 affilate a mano e da manici realizzati in plastica antiurto. High quality scissors with X50CrMoV15 sharp stainless steel blades and shockproof plastic handles.

ART.

dimensioni
size

11941

6"

Forbici da lavoro inox
Stainless steel household scissors



11943

7"

Forbici da sartina inox
Stainless steel seamstress scissors



11806

7"

Forbici multiuso inox dente speciale
Stainless steel multipurpose scissors with special tooth



11944

8,5"

Forbici multiuso inox
Stainless steel multipurpose scissors



11946

9,5"

Forbici da sarto inox
Stainless steel tailor scissors



11945

8"

Forbici da sartina inox
Stainless steel seamstress scissors



Forbici per mancini
Left-handed scissor



FORBICI PROFESSIONALI INOX LINEA AUSONIA

Ausonia stainless steel professional scissors

Le classiche forbici Ausonia con lama in acciaio inox speciale AISI 420, viti e bulloni inox e manici in ABS antiurto.
Ausonia classic scissors with special AISI 420 stainless steel blades and shockproof handles.



Ogni forbice viene fornita con l'apposito blister. Each knife has its own blister.

ART.

dimensioni
size

11907

6,5"

Forbici da lavoro inox
Stainless steel scissors



11909

7,5"

Forbici da lavoro inox
Stainless steel scissors



11800

8,5"

Forbici da sartina inox
Stainless steel seamstress scissors



11900

9"

Forbici multiuso inox
Stainless steel multipurpose scissors



11996

Espositore da banco 24 forbici AUSONIA multiuso
Display box with 24 AUSONIA stainless steel multipurpose scissors

11907 8 pz.

11909 8 pz.

11800 8 pz.



FORBICI INOX LINEA BARRACUDA

Barracuda stainless steel scissors

Forbici con lame microdentate e manici in nylon: soluzioni che sanno riunire qualità e convenienza.
Indented blades and nylon handles combine quality and convenience.



Ogni forbice viene fornita con l'apposito blister. Each knife has its own blister.

ART.

dimensioni
size

11910

5"

Forbici da lavoro inox
Stainless steel scissors



11915

6"

Forbici da lavoro inox
Stainless steel scissors



11920

7"

Forbici da sartina inox
Stainless steel seamstress scissors



11925

9"

Forbici multiuso inox
Stainless steel multipurpose scissors



11997

Espositore da banco 24 forbici BARRACUDA multiuso
Display box with 24 BARRACUDA stainless steel multipurpose scissors

11910 6 pz.

11915 6 pz.

11920 6 pz.

11925 6 pz.

FORBICI LINEA APE

APE SCISSORS LINE

Dall'antica tradizione Ausonia, un ampio assortimento di forbici nichelate stampate a caldo ed affilate a mano.
A wide range of nickel plated forged scissors from Ausonia's ancient manufacturing tradition.

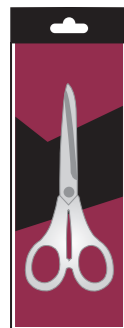

Ogni forbice
viene fornita con
l'apposito blister.
Each knife has its
own blister.



FORBICI LAVORO GAMBO MEZZA RANA ANELLO ROVESCIO

Barracuda stainless steel scissors

Forbici con lame microdentate e manici in nylon: soluzioni che sanno riunire qualità e convenienza.
Utility scissors with bent shank and reverse bow.

ART.	dimensioni size
------	--------------------

13010	4"
-------	----



13015	4,5"
-------	------



ART.	dimensioni size
------	--------------------

13025	5"
-------	----



13035	5,5"
-------	------



13040	6"
-------	----



13045	6,5"
-------	------



13050	7"
-------	----



13055	7,5"
-------	------



13060	8"
-------	----



FORBICI MERCIAIO, SARTINA, UFFICIO

Pocket, sewing and paper shears

Forbici merciaio lama stretta
Pocket scissors with narrow blade

ART. | dimensioni
size

13071 | 3,5"



13072 | 4"



13073 | 4,5"



13074 | 5"



13075 | 5,5"



Forbici sartina anello doppio
Sewing scissors with double bow

ART. | dimensioni
size

13195 | 6"



13200 | 7"



13201 | 7" **Forbici per mancini** - Left-handed scissor



Forbici per mancini
Left-handed scissor

13205 | 8"



Forbice ufficio
Paper shears

13610 | 7"
13612 | 8"
13615 | 9"
13618 | 10"



FORBICI MERCIAIO E RICAMO

Sewing and embroidery shears

Forbici merciaio lama larga
Sewing scissors with large blade

ART. | dimensioni
size

13090 | 4,5"



13100 | 5,5"



13102 | 6,5"



Forbici da ricamo gambo ricamato
Embroidery scissors with embroidered shank

ART. | dimensioni
size

13515 | 4,5"



Forbici da ricamo gambo retto anello rovescio
Embroidery scissors straight shank and reverse bow

13455 | 3,5"



13475 | 4"



Forbici da ricamo gambo retto con anelli larghi
Embroidery scissors straight shank and large bow

13485 | 4"



Forbice da ricamo gambo mezza rana
Embroidery scissors with bent shank

13460 | 3,5"



FORBICI E TRONCHESINI PER UNGHIE

Nail scissors and nippers

Forbici unghie anello rettangolare curve
Curved nail scissors with rectangular bow

ART. | dimensioni
size

13433 | 3,5"



Forbice unghie gambo retto anello rovescio
Curved nail scissors with straight shank and reverse bow

ART. | dimensioni
size

13409 | 3,5" - Curve - Curved



Forbici unghie gambo retto esagonale
Nail scissors with rectangular shank

13403 | 3,5" - Rette - Straight



Tronchesino pedicure
Cuticle and nail nipper

18678 | 14 cm

18822 | Molla ricambio - Spare spring



13406 | 3,5" - Curve - Curved



Tronchesino unghie punte larghe
Large end nail nipper

18670 | 12 cm

18820 | Gilroy-Regular - Spare spring



13439 | 4" - Curve - Curved



Tronchesino pelli punte sottili
Small end nail nipper

18674 | 10 cm

18825 | Gilroy-Regular - Spare spring



FORBICI PER UNGHIE

Nail scissors

Forbici unghie gambo retto punta lancia
Nail scissors with straight shank and lance type point

ART. | dimensioni
size

13421 | 3,5" - Rette - Straight



Forbici unghie gambo retto mezza rana
Nail scissors with bent shank

ART. | dimensioni
size

13415 | 3,5" - Curve - Curved



13427 | 3,5" - Curve - Curved



13416 | 4,5" - Curve - Curved



13430 | 4" - Curve - Curved



FORBICI MANICURE

Cuticle scissors

Forbici manicure a gambi divaricati curve
Curved cuticle scissors with spread shanks

ART. | dimensioni
size

13520 | 4"



Forbici manicure anello rettangolare curve
Curved cuticle scissors with rectangular bow

13330 | 3,5"



Forbice per peli naso
Nose scissors

13500 | 4"



Forbici manicure gambo retto esagonale
Cuticle scissors with straight hexagonal shank

ART. | dimensioni
size

13355 | 3,5" - **Rette** - Straight



13360 | 3,5" - **Curve** - Curved



13345 | 4" - **Rette** - Straight



13350 | 4" - **Curve** - Curved



Forbici manicure a punta lancia
Cuticle scissors with lance type point

13340 | 3,5" - **Curve** - Curved



FORBICI PER PARRUCCHIERI

Barber shears

Forbici parrucchieri modello leggero
Light barber shear

ART. | dimensioni
size

13265 | 6,5"



Forbici parrucchieri per sfoltire lame fresate
Thinning barber shear with milled blades

13283 | 6,5"



ESPOSITORE DA BANCO LINEA MANICURE

MANICURE line exhibitor

ART.

13992

Espositore da banco in plastica completo di 33 forbici Ausonia linea MANICURE
Plastic exhibitor with 33 Ausonia MANICURE scissors

- 8 modelli esposti:
cod. 13433 - Forbice unghie curva pl. 3,5 - 6 pezzi
cod. 13330 - Forbice pelli curva pl. 3,5 - 6 pezzi
cod. 13340 - Forbice pelli p. lancia curva pl. 3,5 - 3 pezzi
cod. 13350 - Forbice pelli curva pl. 4 - 3 pezzi
cod. 13409 - Forbice unghie p. lancia curva pl. 4 - 3 pezzi
cod. 13416 - Forbice unghie curva pl. 4,5 - 3 pezzi
cod. 18670 - Tronchesino unghie cm 12 - 6 pezzi
cod. 18678 - Tronchesino unghie cm 14 - 3 pezzi
- 8 articles displayed:
cod. 13433 - Curved nail scissor 3,5" - 6 pieces
cod. 13330 - Curved cuticle scissor 3,5" - 6 pieces
cod. 13340 - Curved cut. scissor with lance type point 3,5" - 3 pieces
cod. 13350 - Curved cuticle scissor 4" - 3 pieces
cod. 13409 - Curved nail scissor with lance type point 4" - 3 pieces
cod. 13416 - Curved nail scissor 4,5" - 3 pieces
cod. 18670 - Large end nail nipper cm 12 - 6 pieces
cod. 18678 - Cuticle and nail nipper cm 14 - 3 pieces

cm 52
cm 29
cm 36

ESPOSITORE DA BANCO LINEA CASA

HOME line exhibitor

ART.

13993

Espositore da banco in plastica completo di 33 forbici Ausonia linea CASA
Plastic exhibitor with 33 Ausonia HOME scissors

- 8 modelli esposti:
cod. 13455 - Forbice ricamo pl. 3,5 - 3 pezzi
cod. 13485 - Forbice ricamo pl. 4 - 3 pezzi
cod. 13072 - Forbice merciaio lama stretta pl. 4 - 3 pezzi
cod. 13015 - Forbice lavoro pl. 4,5 - 3 pezzi
cod. 13025 - Forbice lavoro pl. 5 - 6 pezzi
cod. 13035 - Forbice lavoro pl. 5,5 - 6 pezzi
cod. 13045 - Forbice lavoro pl. 6,5 - 3 pezzi
cod. 13200 - Forbice sartina pl. 7 - 6 pezzi
- 8 articles displayed:
cod. 13455 - Embroidery scissor 3,5" - 3 pieces
cod. 13485 - Embroidery scissor 4" - 3 pieces
cod. 13072 - Pocket scissor with narrow blade 4" - 3 pieces
cod. 13015 - Utility scissor 4,5" - 3 pieces
cod. 13025 - Utility scissor 5" - 6 pieces
cod. 13035 - Utility scissor 5,5" - 6 pieces
cod. 13045 - Utility scissor 6,5" - 3 pieces
cod. 13200 - Sewing scissor 7" - 6 pieces

cm 52
cm 29
cm 36

FORBICI LINEA NB

NB SCISSORS LINE

Dall'antica tradizione Ausonia, un ampio assortimento di forbici nichelate stampate a freddo ed affilate a mano.
A wide range of nickel plated forged scissors from Ausonia's ancient manufacturing tradition.

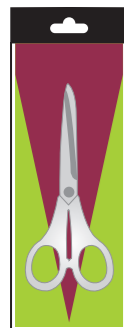

Ogni forbice viene fornita con l'apposito blister. Each knife has its own blister.



Forbici lavoro gambo mezza rana anello rovescio
Utility scissors with bent shank and reverse bow

ART.	dimensioni size
------	-----------------

15020	5"
-------	----



15025	5,5"
-------	------



15030	6"
-------	----



15040	7"
-------	----



Forbici merciaio lama stretta
Pocket scissors with narrow blade

ART.	dimensioni size
------	-----------------

15095	4,5"
-------	------



15100	5"
-------	----



FORBICI PER MERCIAIO, SARTINA, RICAMO E UNGHIE

Pocket, sewing embroidery and nail scissors

Forbici sartina anello doppio
Sewing scissors with double bow

ART.	dimensioni size
------	-----------------

15200	7"
-------	----



Forbici da ricamo gambo retto anello rovescio
Embroidery scissors straight shank and reverse bow

15460	3,5"
-------	------



Forbici unghie gambo retto esagonale
Nail scissors with rectangular shank

15405	3,5" - Curve - Curved
-------	-----------------------



15333	3,5" - Curve - Curved
-------	-----------------------



TRONCHESI E PINZETTE

Cuticle scissors

Tronchesi
Cuticle and nail clippers

ART. | dimensioni
size

18658

Tronchesino modello fine
Top quality cuticle clipper



18700

Tronchesino grande con limetta in blister
Large cuticle clipper with file - blister

18701

In barattolo 36 pz.
Jar 36 pcs



18695

Tronchesino con limetta in blister
Cuticle clipper with file - blister

18696

In barattolo 72 pz.
Jar 72 pcs



Pinzette depilatorie
Eyebrow tweezers

ART. | dimensioni
size

18720

Pinzetta depilatoria inox retta
Stainless steel straight eyebrow tweezer



18725

Pinzetta depilatoria inox obliqua
Stainless steel slanting eyebrow tweezer



18740

Pinzetta depilatoria brunita retta
Burnished straight eyebrow tweezer



18745

Pinzetta depilatoria brunita obliqua
Burnished slanting eyebrow tweezer



SET E COFANETTO MANICURE

Manicure set

Astucci manicure in pelle
Leather manicure sets

ART. | dimensioni
size

18962

Set manicure in pelle grande 8 pz inox
Leather manicure set 8 stainless steel pieces



ART. | dimensioni
size

18960

Cofanetto manicure in pelle 5 pezzi inox
Leather manicure set 5 stainless steel pieces

ART.

18958

Set manicure in pelle piccolo 3 pz inox
Leather manicure set 3 stainless steel pieces



FORBICI PER TESSITORI, TAGLIACAMPIONI, CUOIO

Weaver and pinking shears

Forbici per tessitori Weaver scissors

ART. | dimensioni
size

13901

Forbici cromate rette 1° qualità APE
APE weaver straight chromium-plated scissors



13903

Curve
Curved



16350

Forbici con manici in plastica lama inox
Weaver scissors with plastic handle and stainless steel blade



Forbici tagliacampioni Pinking shears

ART. | dimensioni
size

16309 | 7,5"

Forbici tagliacampioni linea APE
APE pinking shears



Forbice da cuoio lame brunate Heavy duty leather burnished blade scissors

16302 | 8"



Forbici da sarto lame nichelate 1a qualità APE Ape nichel plated blades tailor scissors

ART. | dimensioni
size

16145 | 7"
16147 | 8"
16149 | 9"
16151 | 10"



Forbici da sarto lame brunate 1a qualità APE Ape burnished blades tailor scissors

16157 | 7"
16159 | 8"
16161 | 9"
16163 | 10"
16165 | 11"
16167 | 12"



FORBICI DA SARTO

Tailor scissors

ART. | dimensioni
size

16148 | 8" - **Forbici per mancini**
Left-handed scissor



Forbici per mancini
Left-handed scissor

Forbice da sarto lame nichelate e microdentate tipo Wiss APE Ape tailor scissors mod. Wiss with nichel plated and microtoothed blades

16143 | 8"



ESPOSITORI

Displays

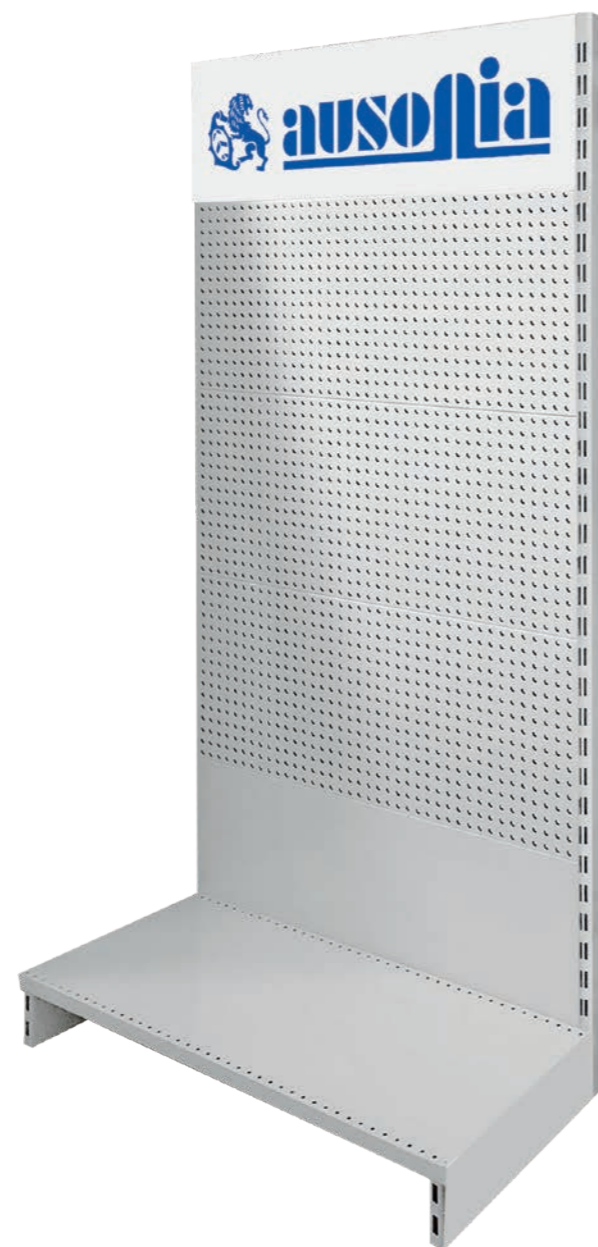
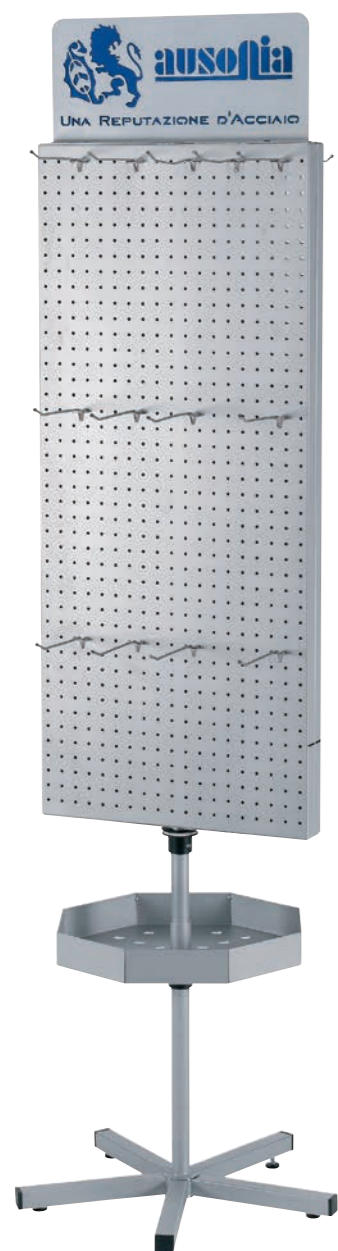

Espositore a griglia girevole completo di ganci
Rotating display with hooks

ART. | dimensioni
size

99097 | H 200 cm x P 60 cm

Espositore base 1 metro
Display

ART. | dimensioni
size

99141 | H 195 cm x P 51 cm

ESPOSITORE DA BANCO

Display



Espositore da banco
Display

ART. | dimensioni
size

99072 | H 60 cm x P 29 cm



Art.	Pag.
FORBICI INOX MANICO PLASTICA Stainless steel scissors with plastic handle	
11800	78
11806	77
11900	78
11907	78
11909	78
11910	79
11915	79
11920	79
11925	79
11941	77
11943	77
11944	77
11945	77
11946	77
11994	77
11996	78
11997	79
FORBICI NICHELATE PRIMA QUALITÀ LINEA APE APE top quality nichel plated scissors	
13010	81
13015	81
13025	81
13035	81
13040	81
13045	81
13050	81
13055	81
13060	81
13071	82
13072	82
13073	82
13074	82
13075	82
13090	83

Art.	Pag.
13100	83
13102	83
13195	82
13200	82
13201	82
13205	82
13265	87
13283	87
13330	88
13340	88
13345	86
13350	86
13355	86
13360	86
13403	84
13406	84
13409	84
13415	85
13416	85
13427	85
13430	85
13433	88
13439	84
13455	89
13460	83
13475	83
13485	83
13500	86
13515	83
13520	86
13610	82
13612	82
13615	82
13618	82
13901	94
13903	94
13992	88
13993	89

Art.	Pag.
FORBICI NICHELATE LINEA NB NB nichel plated scissors	
15020	90
15025	90
15030	90
15040	90
15095	91
15100	91
15200	91
15333	91
15405	91
15460	91
FORBICI DA SARTO Tailor scissors	
16143	95
16145	95
16147	95
16148	95
16149	95
16151	95
16157	95
16159	95
16161	95
16163	95
16165	95
16167	95
FORBICI PER MESTIERI Trade scissors	
16302	94
16309	94
16350	94

Art.	Pag.
ARTICOLI MANICURE E UFFICIO Manicure and office items	
18658	92
18670	84
18674	84
18678	84
18695	92
18696	92
18700	92
18701	92
18720	92
18725	92
18740	92
18745	92
18820	84
18822	84
18825	84
18958	93
18960	93
18962	93
ARTICOLI PER MACELLERIA Tools for butches	
58005	70
58010	70
58015	70
58020	70
58025	70
58027	70
58030	70
58032	70
58035	70
58038	70
58040	70
58050	70
58055	70
58060	70
58064	70
58065	70
58066	70

Art.	Pag.
58090	23
58299	69
58300	69
58302	69
58305	69
58307	69
58310	69
58315	69
58320	69
58325	69
58330	69
58340	69
58345	69
58350	69
58355	69
58365	69
58405	70
58410	70
58455	69
58500	73
58510	73
58530	73
COLTELLI FORGIATI LINEA AVANT Forged cutlery - Avant line	
61158	9
61159	9
61161	10
61162	10
61163	10
61165	9
61166	10
61168	9
COLTELLERIA DA CUCINA LINEA BARRACUDA Barracuda kitchen cutlery line	
61530	46
61566	46
61567	46

Art.	Pag.
COLTELLI TAVOLA, BISTECCA E VARI Various knives	
61602	46
61642	47
61647	47
61651	47
61652	47
COLTELLERIA PROFESSIONALE LINEA PREMIERE Professional cutlery - Premiere line	
61731	15
61733	15
61735	15
61737	15
COLTELLERIA TRADIZIONALE LINEA AUSONIA LEGNO Ausonia legno traditional wooden handle cutlery	
61170	41
62205	41
62215	41
62220	41
62270	41
62290	41
62307	40
62313	41
62323	41
62333	40
62335	40
62343	40
62348	40
62360	40
62364	41
62405	40
62407	40



Art.	Pag.
COLTELLERIA DA CUCINA LINEA UNIKO Uniko kitchen cutlery line	
62601	43
62621	43
62624	43
62628	43
62632	43
62654	43
62660	43
COLTELLERIA DAMASCATA LINEA PHOENIX Phoenix damascus knives	
62811	13
62812	13
62813	13
62814	13
62816	13
COLTELLI DA FORMAGGIO Cheese knives	
63005	28
63017	28
63022	28
63025	28
63032	28
63035	28
63040	28
63043	28
63052	29
63054	29
63060	28
63150	29
63203	29
63302	29

Art.	Pag.
SPATOLE DA CUCINA Kitchen spatulas	
64090	26
64095	26
64100	26
64105	26
64110	26
64115	26
MANNAIE E FORCHETTONI Cleavers and forks	
64311	30
64315	30
64318	30
64330	31
64332	31
64407	73
64410	73
TAGLIERI, RICAMBI E BLOCCHI PORTACOLTELLI Chopping boards, spare parts and wooden blocks for knives	
66401	71
66404	71
66405	71
66406	71
66409	71
66410	71
66411	71
66414	71
66415	71
66416	71
66419	71
66420	71
66421	71
66422	71
66600	41
66623	49
66630	49

Art.	Pag.
AFFILATOI PROFESSIONALI Professional sharpeners	
67005	52
67010	52
COLTELLERIA PROFESSIONALE LINEA ESPERIA Esperia professional cutlery line	
67243	38
67244	38
67245	38
67247	38
67248	38
67249	38
67250	38
67252	38
67257	38
67260	38
67267	38
67269	36
67270	36
67272	36
67276	38
67277	38
67282	36
67284	37
67286	37
67288	35
67290	36
67291	36
67292	36
67295	36
67298	38
67301	35
67302	35
67304	35
67305	35
67307	36
67311	35
67312	35

Art.	Pag.
67314	35
67315	35
67316	35
67321	36
67322	36
67326	36
67332	37
67334	37
67336	37
67342	36
COLTELLERIA PROFESSIONALE LINEA CHEF MASTER Chef Master professional cutlery line	
67401	21
67402	21
67403	21
67404	21
67405	21
67406	21
67407	21
67409	21
67410	21
67412	21
67413	21
67414	21
67415	21
67416	21
67418	21
67421	20
67423	20
67425	20
67427	20
67428	20
67433	20
67434	20
67435	20
67437	20
67438	20
67447	22
67448	22

Art.	Pag.
67449	17
67450	17
67451	17
67453	19
67454	19
67455	19
67456	19
67459	19
67460	19
67461	19
67462	19
67464	19
67466	19
67467	19
67470	19
67471	24
67472	24
67473	24
67474	24
67475	24
67476	24
67477	24
67478	24
67479	24
67480	24
67481	21
67483	21
67485	21
67486	21
67488	21
67489	19
67491	23
67492	23
67494	23
67495	23
67497	23
67500	20
67501	23
67504	22
67506	22
67507	22

Art.	Pag.
67508	22
67511	25
67512	17
67513	17
67514	17
67516	17
67517	17
67518	18
67520	18
67521	18
67522	18
67523	18
67525	18
67526	18
67527	18
67528	18
67530	25
67533	29
67602	21
67603	21
67605	21
67606	21
67607	21
67616	21
67617	21
67618	21
67619	20
67632	20
67638	17
67648	19
67651	17
67661	17
67667	17
67676	20
67681	24
67836	26
67837	27
67838	27
67839	27
67840	26
67841	26



Art.	Pag.
67846	27
67848	27
67859	25
67980	28
PORTAPROSCIUTTO Ham holders	
68301	72
68303	72
68305	72
UTENSILI CASALINGHI Houseware	
71015	60
71043	60
71056	58
71058	58
71172	67
71237	57
71239	57
71240	57
71251	56
71252	56
71254	57
71255	57
71260	40
71310	55
71313	55
71340	57
71430	55
71495	54
71496	54
71498	54
71501	54
71505	56
71508	54
71510	69
71516	69
71520	69
71538	59
71540	59

Art.	Pag.
71541	59
71542	59
71543	59
71544	59
71551	58
71555	55
71560	64
71566	64
71605	64
71610	64
71616	64
71622	56
71626	27
71627	27
71630	59
71631	59
71635	59
71644	58
71650	56
71674	65
71677	65
71678	65
71684	65
71691	64
71692	64
71697	65
71698	65
71699	65
71701	65
71703	65
71706	67
71711	66
71786	66
71787	67
71789	66
71792	66
71796	59
72005	68
72007	68
72018	60
72105	58

Art.	Pag.
72112	58
72212	53
72305	63
72322	63
72326	63
72339	62
72340	62
72346	62
72354	62
72370	62
72376	63
72650	52
72658	52
72660	52
72662	53
72673	52
72675	53
72695	67
72700	55
72708	60
ACCESSORI E RICAMBI PER CASALINGHI Fittings and spare parts for houseware	
73100	55
73610	68
73611	68
73612	68
73613	68

Art.	Pag.
COLTELLERIA IN CEPPI E CONFEZIONI Cutlery in wooden blocks and sets	
96254	25
96400	11
96521	45
96526	47
97644	25
ESPOSITORI Exhibitors	
99072	97
99097	96
99141	96
BARRE MAGNETICHE Universal magnetic rack	
99178	49
99179	49

modalità di spedizione shipment procedures

La merce viaggia a rischio del committente.
Sarà cura del cliente controllare il numero dei colli ricevuti e la loro integrità.
The goods travel at the risk of the purchaser.
It's the customer's obligation to check the number of items received and their condition upon arrival.

prezzi e imballo prices and packaging

I prezzi si intendono iva esclusa e potranno essere modificati da Ausonia in qualsiasi momento senza alcun preavviso. L'imballo è più che adeguato alle esigenze del trasporto, pertanto eventuali manomissioni od avarie presenti nell'imballo al momento della consegna dovranno essere contestate direttamente al vettore. Le spese d'imballo sono a carico di Ausonia.
Prices are VAT excluded and can be modified by Ausonia at any time without notice.
The packaging is more than suitable for the transport needs, therefore any tampering or damage to the packaging during delivery must be reported to the carrier.
The packaging costs are at Ausonia's charge.

resi di merci return of goods

I resi di merce dovranno essere autorizzati da Ausonia e saranno accettati solo se resi in porto franco e corredati dalla necessaria documentazione fiscale.
Return of goods must be authorized by Ausonia and will be accepted only if sent carriage free and together with all the necessary fiscal documentation.

modalità di consegna delivery of the goods

Ausonia si riserva la facoltà di evadere ordini anche parzialmente in relazione alle esigenze di lavorazione o alle disponibilità di magazzino.
Ausonia reserves the authority to process orders, even partially, in relation to processing needs or stock availability.

pagamenti payment

I pagamenti devono essere fatti direttamente alla Ausonia Nanutti Beltrame Spa al proprio domicilio di Maniago (PN).
La vendita viene fatta con la riserva di proprietà di cui all'art. 1523 c.c., pertanto i beni venduti passeranno in proprietà del Compratore soltanto al momento del saldo totale.
Su tutte le fatture scadute saranno applicati, in forma di sollecito, gli interessi di mora previsti per legge, nonché le spese di gestione della pratica.
Any sales is carried out with ownership reservation, according to art. 1523 of the Italian Civil Code. Therefore, the ownership of the goods will pass on the Buyer only when their whole amount has been settled.
On all overdue invoices will be applied, in the form of a reminder, the default interest provided for by law, as well as the costs of handling the practice.

garanzia warranty conditions

Il difetto di conformità rientra nella garanzia di legge se si manifesta entro due anni dalla data di consegna del bene secondo il Codice del Consumo. Per gli acquisti con Partita IVA non vale il Codice del Consumo ma il Codice Civile che prevede un diritto di garanzia di un solo anno.
La garanzia di uno o due anni, a seconda della tipologia di acquirente, copre la batteria, il motore, il meccanismo di trasmissione, la scheda elettronica, il cavo ed il caricabatterie. Tutti gli altri componenti saranno coperti da garanzia solo per i primi 3 mesi in quanto soggetti ad usura.
Il documento di garanzia presente nel manuale, debitamente compilato, dovrà essere accompagnato dalla fattura o scontrino di acquisto del prodotto. Tali documenti costituiscono elemento essenziale per potersi avvalere della garanzia applicata al prodotto.
Il titolare dovrà rivolgersi solamente al rivenditore ove ha acquistato il prodotto.
La garanzia non può in nessun caso coprire indennità per eventuali fermi lavoro durante la riparazione/manutenzione.
Sono esenti dalla garanzia i danni provocati da applicazioni non descritte dal manuale d'uso e, in generale, applicazioni diverse da quelle di un normale utilizzo, colpi dovuti a cadute, agenti esterni (calcare, prodotti chimici, entrata d'acqua, incendi, fulmini, ecc).
La garanzia non comprende difetti estetici derivanti dall'uso normale del prodotto e dagli interventi di manutenzione periodica descritti nel manuale d'uso e realizzati dall'acquirente. Questa garanzia non include i pezzi di ricambio (lama, controlama, copertura superiore, inferiore e frontale, zaino, ecc).
Ausonia will guarantee 1-year warranty for the following parts: battery, electronic components, engine and transmission mechanism.
All other components will be covered by a warranty for the first 3 months after sale.
The customer must contact only Ausonia authorized service centers.
The warranty won't cover indemnities for any work breaks during repair or maintenance.
Damages caused by applications not described in the user's manual or by applications other than normal use are excluded from the warranty.
Warranty does not include aesthetic defects caused by normal use of the product and from periodic maintenance described in the user's manual.
The warranty does not include spare parts.

reclami claims

Reclami per merce difettosa o mancante devono essere presentati ad Ausonia entro otto giorni dal ricevimento della stessa.
Reclami per consegne incomplete o danneggiate devono essere immediatamente presentati al vettore al ricevimento della merce (entro 24 ore).
Claims for faulty goods or missing goods must be communicated to Ausonia within 8 (eight) days after receiving the shipment.
Claims for damaged or missing goods must be immediately notified to the forwarding agent when receiving the shipment (within 24 hours).

forza maggiore force majeure

Ciascuna parte potrà sospendere o non eseguire i propri obblighi contrattuali qualora l'adempimento risulti oggettivamente impossibile o irragionevolmente oneroso a causa di un evento imprevedibile ed indipendente dalla sua volontà, quale, ad esempio, sciopero, boicottaggio, serrata, incendio, guerra, guerra civile, sommossa, rivoluzione, requisizione, embargo, interruzione di energia, pandemia, terremoto o altra grave calamità naturale.
Any party can suspend or unfulfill its contractual obligation when the accomplishment turns out to be objectively impossible or unreasonably onerous due to an unpredictable event beyond its control and will, such as for example, strike, boycotting, lockdown, fire, war, civil war, insurrections, revolutions, requisitions, embargo, power supply interruption, pandemic, earthquakes or other major natural disaster.

contestazioni disputes

Qualunque contestazione non dà diritto al compratore di sospendere o ritardare i pagamenti. Per qualsiasi controversia derivante da affari trattati da Ausonia Nanutti Beltrame Spa o da propri agenti, l'autorità competente è quella giudiziaria di Pordenone.
La legge applicabile è quella italiana.
Any dispute does not entitle the buyer to suspend or delay payments.
For any dispute arising from business handled by Ausonia Nanutti Beltrame SpA or its agents, the competent authority is the judicial authority of Pordenone, Italy.
The applicable law is the Italian law.

Ausonia si riserva di apportare modifiche agli articoli del catalogo senza l'obbligo di preavviso. Nella compilazione del catalogo possono essersi verificati errori di stampa.
Ausonia can modified the products included in this catalogue without notice. Printing errors may have affected the completeness of the catalogue.





Ausonia Nanutti Beltrame spa

Via Arba 31 - 33085 Maniago (PN) Italy
tel. +39 0427 71251
fax +39 0427 700316
www.ausoniatools.com
info@ausoniatools.com

Codice Fiscale e Partita IVA:
00074580937

Capitale sociale: 2.400.000,00 i.v.
C.C.I.A.A. PN n.59

Agente
Agent

Distributore
Distributor

Rivenditore
Dealer