



ARCHman

MANIAGO - ITALY

CATALOGUE 2022 / 2023

SINCE 1968 MANUFACTURERS OF PROFESSIONAL PRUNING TOOLS



For general information please contact:
Use balanced table only!
If you have any questions please contact:
Mitsubishi exclusively through Mitsuboshi!

<i>THE COMPANY AND PRODUCTION</i>	2
<i>TOP PRUNER</i>	4
<i>TELESCOPIC POLES</i>	11
<i>PROFESSIONAL PRUNING SHEARS</i>	12
<i>GARDEN AND GRAPE HARVESTING SHEARS</i>	20
<i>GRASS AND RATCHET SHEARS</i>	22
<i>LONG REACH PRUNER ALUMINIUM HANDLE</i>	23
ELECTRIC PRUNING TOOLS	
<i>LOPPERS</i>	26
<i>HEDGE SHEARS</i>	28
<i>SAWS</i>	30
<i>GARDEN TOOLS</i>	35
<i>TYING MACHINE AND MANUAL GRAFTING</i>	36
<i>PRUNING HOOKS - GRAFTING KNIVES - KNIVES</i>	38
<i>STONE SHARPENERS</i>	39
<i>OLD BEAR RANGE</i>	41
<i>HOLDER SHEARS</i>	46
<i>DISPLAYS</i>	47
<i>FOREX SIGNS</i>	48
<i>MERCHANDISING</i>	49

ARCHMAN

MANIAGO - ITALY

PRODUCTION MADE IN ITALY

the phases

1

DIE AND TOOL CONSTRUCTION

Once the prototypes are approved and preproduction is carried out, the design and creation of dies follows (dies for metal shearing, dies for metal padding, dies for plasticizing plastic materials).

Continuous investments with new technologically cutting-edge machinery and frequent training programs for staff allow the dies to be produced quickly, guaranteeing maximum precision.

Great importance is also given to the purchase the raw materials used to be of the highest quality

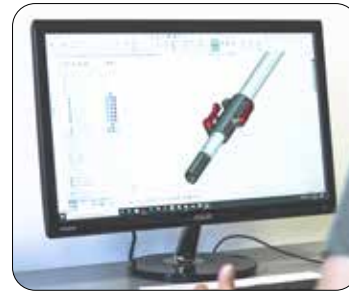

PRODUCTION

ARCHMAN is rich in values and opportunities; just think of its internal planning ability.

Our technical office is a bit like the heart of all the activity; the staff, with many years experience, uses cutting-edge software and is continually trained.

This allows us to increase, develop and improve our production line and to satisfy the customized requests of clients.

For each product, a feasibility study is carried out by creating 3D prototypes.

2

OF HIGH QUALITY

ARCHMAN brand includes products from Archman Ltd.

Present in the market for the last fifty years with its own production of shears for vineyards, orchards, and gardening.

It is synonymous with loyalty to the needs and tastes of its ever-changing clientele, which includes both professional operators and hobbyists.

Its distinctive features come from the total care with which its products are made: solid and efficient for the technical operations for which they were designed, agile and manageable so that utility and comfort are effortlessly united for their clients.

3

WASHES AND PACKAGING

After having passed inspection, the finished product is washed with oily substances to make the blades, springs and gear smooth and to make them rust-resistant.

The final phase consists in packaging them in very practical single, plastic envelopes or in press-through packaging and then in corrugated cardboard boxes containing various quantities depending on the size of the item and appropriately stored in a warehouse.

The finished product warehouse is well stocked so orders can be shipped in the least amount of time possible, guaranteeing the client with rapid service.

5



PRODUCTION CYCLE

The production cycle to produce these items is carried out almost completely within the company, except for several processes (thermal treatments and coating materials) which are outsourced. This guarantees that all controls are carried out in order to produce a quality product.

All the various production phases, with all controls to perform, are reported on the appropriately analyzed forms where potential important non-compliances are listed in order to separate the well marked and defined areas.

Suppliers are selected after an attentive evaluation of the quality of the products supplied and the timeliness of the service offered.

4

POST-SALES ASSISTANCE

Customer service does not end with the shipment of the order; post-sales assistance is guaranteed. Easily replaceable spare parts are available for all Archman products to ensure their longevity.

In addition, local agents constantly visit clients and inform them of the latest news (new products, price lists, promotions, etc.).

**SHEARS THAT ONLY
ARCHMAN CAN GIVE
ITS NAME**

ARCHMAN

MANIAGO - ITALY

The new top pruner **HELIUM** ARCHMAN is a very light tool, its weight is only gr. 1630, without effecting its resistance, as the cutting body is printed in **NYLON** reinforced with **CARBON FIBER** while the rope is in **DYNEEMA** with very high tenacity.

All this, along with the reduce movement of the handle for cutting operation, allows for an ultra-lightweight, super-resistant and super-fast tools, suitable for both professional and hobby. The extendable handle, from 2,4 mt. up to 4 mt., in anodized aluminum makes it easy to reach the most difficult points up to a height of 5,5 mt. without the use of the stair while the super compact cutting head easily enters inside the dense vegetation branches without getting caught and is tilted and adjustable on both sides (110° and 60°).

The blade is Teflon coated to reduce the friction and the cutting effort, to avoid the rust and dirty.



HELIUM

Ø 35 mm



Cutting angle adjustable from both side 110° and 60°



ITEM 30 TOP PRUNER HELIUM BY-PASS

Alloyed carbon steel **BLADE** tempered HRC 54÷56 with non stick coating fluoropolymer

Stainless steel **COUNTERBLADE**

Nylon plus carbon fiber **PLASTIC FRAME**

Dyneema with very high toughness **CUT HEAD ROPE**

Nylon plus carbon fiber **TIE-ROD BLADE**

Tempered steel **BOLT**

Anodized and painted aluminum telescopic **HANDLE** equipped with a rib that allows the passage of the rope and at the same time makes it more rigid and bending.

CODE	LENGHT	WEIGHT	CUT Ø	PACKAGING
300	from mm 2360 to mm 4000	gr. 1680	35	Carton box of 2 pcs.
334	from mm 1680 to mm 2675	gr. 1270	35	Carton box of 2 pcs.

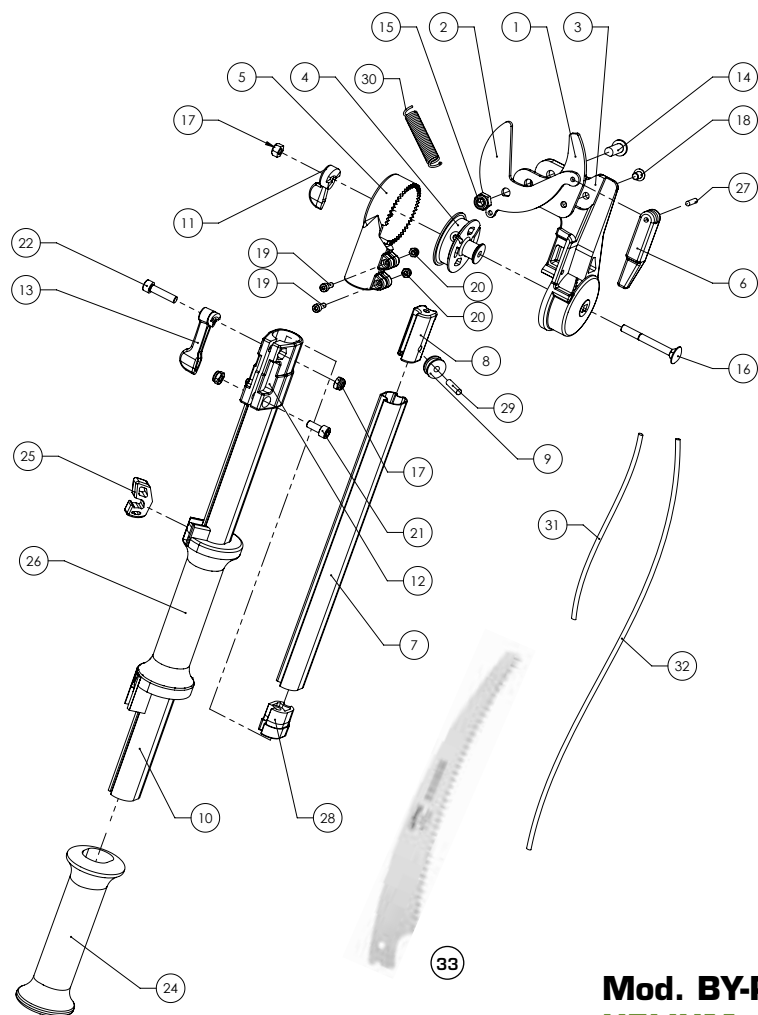

Mod. BY-PASS HELIUM

SPARE PARTS HELIUM ITEM 30 BY-PASS

Cod.	Description	Ref. N.
301	Steel counter-blade	1
302	Teflon steel blade	2
1015	Kit curved saw blade 330 mm	33
303	Nylon counter-blade + carbon fiber	3
330	Kit head cut	4+6+27+31
305	Nylon aluminium tube guard + carbon fiber	5
287	Aluminium internal tube mt.2 With plug	7+28
331	Aluminium internal tube mt.4 With plug	7+28
332	Kit slide bar	8+9+29
165	Aluminium external tube mt.4	10
310	Guard closing wing nut	11
171	Clamp	12
333	Kit aluminium tube locking lever	13+17+22
1029	Bolt and nut for head cut	14+15
469	Guard assembly screw with nut	16+17
167	Clamp screws with nut	17+21
316	Conterblade screw	18
174	Locking guard bolt and nut	19+20
299	Lower plastic handle	24
172	Blade closing lock with plastic handle	25+26
327	Spring	30
329	Aluminium tube rope mt.4	32
286	Aluminium tube rope mt.2	32

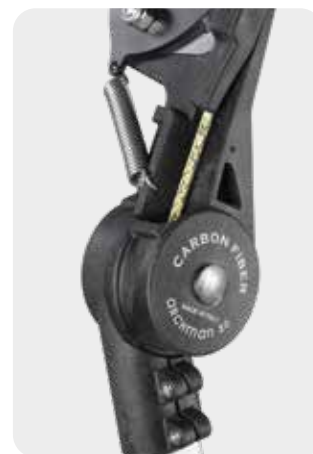

Nylon plus carbon fiber plastic frame - Dyneema cut head rope



Safety blade closing lock

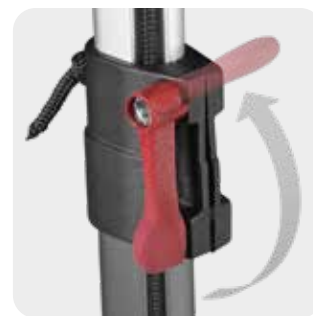

Telescopic pole up to 4 mt with locking lever

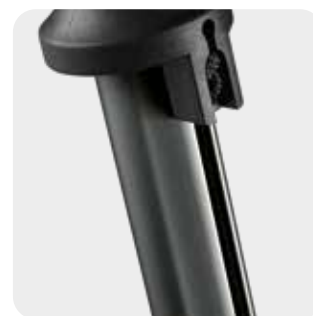

Anodized and painted aluminum telescopic pole



ARCHMAN

MANIAGO - ITALY

The top pruner **SNIPER ARCHMAN** by-pass and anvil blade is the perfect tool to cut olive and all kind of fruit trees and plants in general. It is a tool that for its system of pulleys needs a minimum effort to make a neat and precise cut of \varnothing 37 mm for the anvil version and \varnothing 40 mm for the by-pass version. Sniper is lightweight and easy to handle, the aluminum handle is easily extensible reaching 2 or 4 m. The head is adjustable both right and left with an inclination of 110° from one side and 45° from the other side. With a simple loosening of the fixing knot, the position of the upper red plastic handle is adjustable depending on the grip of the operator. The blade has a non-stick coating fluoropolymer which reduces friction, prevents rust, reduces the accumulation of dirt, reduces fatigue and keeps it sharp longer. The new version of **SNIPER evolution** anvil and by-pass blade, has added a second plastic handle and a safety lock for the blade.



\varnothing 37 mm

Telescopic handle
easy to extend

The opening of the blade
is so large as to allow
the cutting of branches
with a diameter up to 37 mm

AVAILABLE IN TWO
DIFFERENT LENGTHS

from 1670 mm up to 2570 mm
from 2385 mm up to 4075 mm

TOP PRUNER SNIPER

ITEM 5

TOP PRUNER SNIPER ANVIL BLADE *evolution*

Alloyed carbon steel **BLADE** tempered HRC 54 ÷ 56 with non-stick coating fluoropolymer

Carbon steel **COUNTER BLADE** tempered HRC 53 ÷ 55 coated nylon reinforced with fiber glass

Alloyed carbon steel **LEVER** tempered HRC 48 ÷ 50

Tempered steel **BOLTS** with self-locking latch

The **PLASTIC FRAME** is in nylon reinforced with fiber glass

Anodized and painted aluminum telescopic **HANDLE** equipped with a rib that allows the passage of the rope and at the same time makes it more rigid to bending



CODE	LENGTH	WEIGHT	CUT \varnothing	PACKING
750	from 1670 mm up to 2570 mm	1590 g	37 mm	2 piece box
751	from 2385 mm up to 4075 mm	2000 g	37 mm	2 piece box



SNIPER *evolution*



Double-balanced handle with cut-off (pull themselves)



Safety lock for the blade



110°

Ø 40 mm

AVAILABLE IN TWO DIFFERENT LENGTHS

from 1670 mm up to 2605mm
from 2370 mm up to 4065 mm

POSSIBILITY OF APPLYING A CURVED SAW BLADE OF 330 MM



ITEM 5

TOP PRUNER SNIPER BY-PASS BLADE *evolution*

Alloyed carbon steel **BLADE** tempered HRC 54 ÷ 56 with non-stick coating fluoropolymer
Carbon steel **COUNTER BLADE** tempered HRC 53 ÷ 55 coated nylon reinforced with fiber glass
Tempered steel **BOLT** with self-locking latch
The **PLASTIC FRAME** is in nylon reinforced with fiber glass
Anodized and painted aluminum telescopic **HANDLE** equipped with a rib that allows the passage of the rope and at the same time makes it more rigid to bending

CODE	LENGTH	WEIGHT	CUT Ø	PACKING
725	from 1670 mm up to 2605 mm	1560 g	40 mm	2 piece box
726	from 2370 mm up to 4065 mm	1960 g	40 mm	2 piece box

SAW BLADE WITH NUT, BOLT AND WASHER

Code 186 - BLADE mm 330



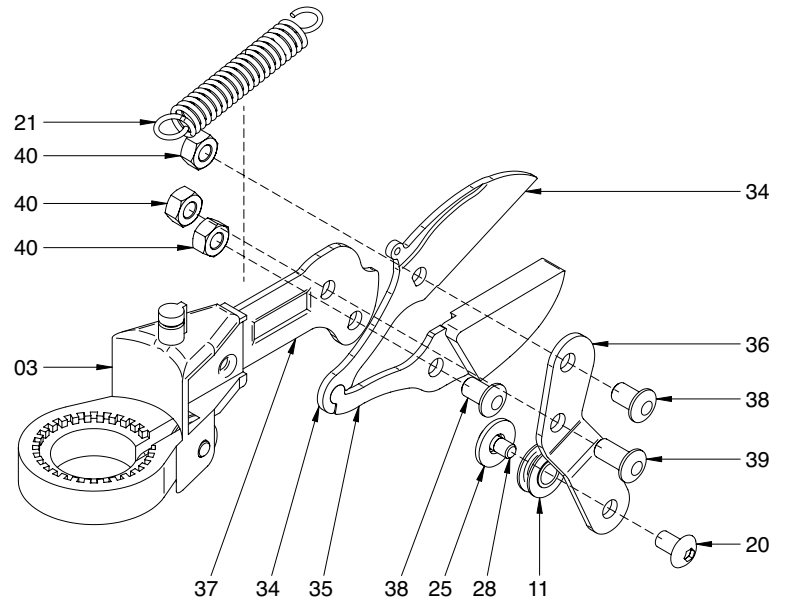

ANVIL Model *evolution*

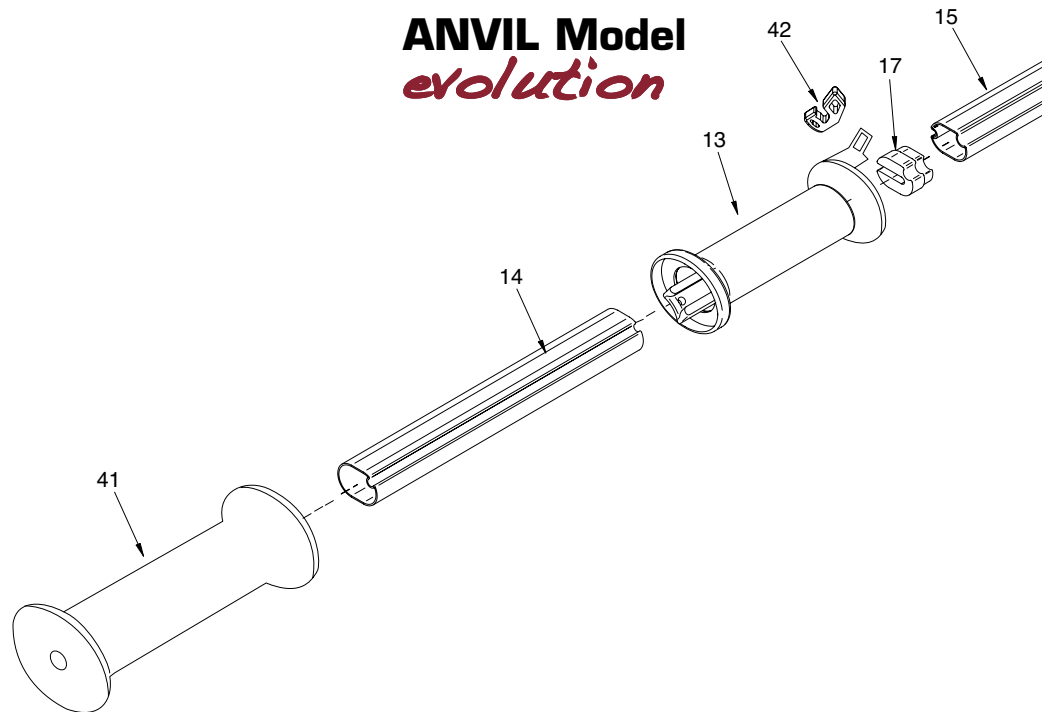

COMPONENTS OF THE PRUNER SNIPER BY-PASS



Code	Description	Part in design
727	By-pass blade	1
760	Counter blade with plastic holder	2+3
729	Bolt and nut for blade	23+29

COMPONENTS OF THE PRUNER SNIPER ANVIL

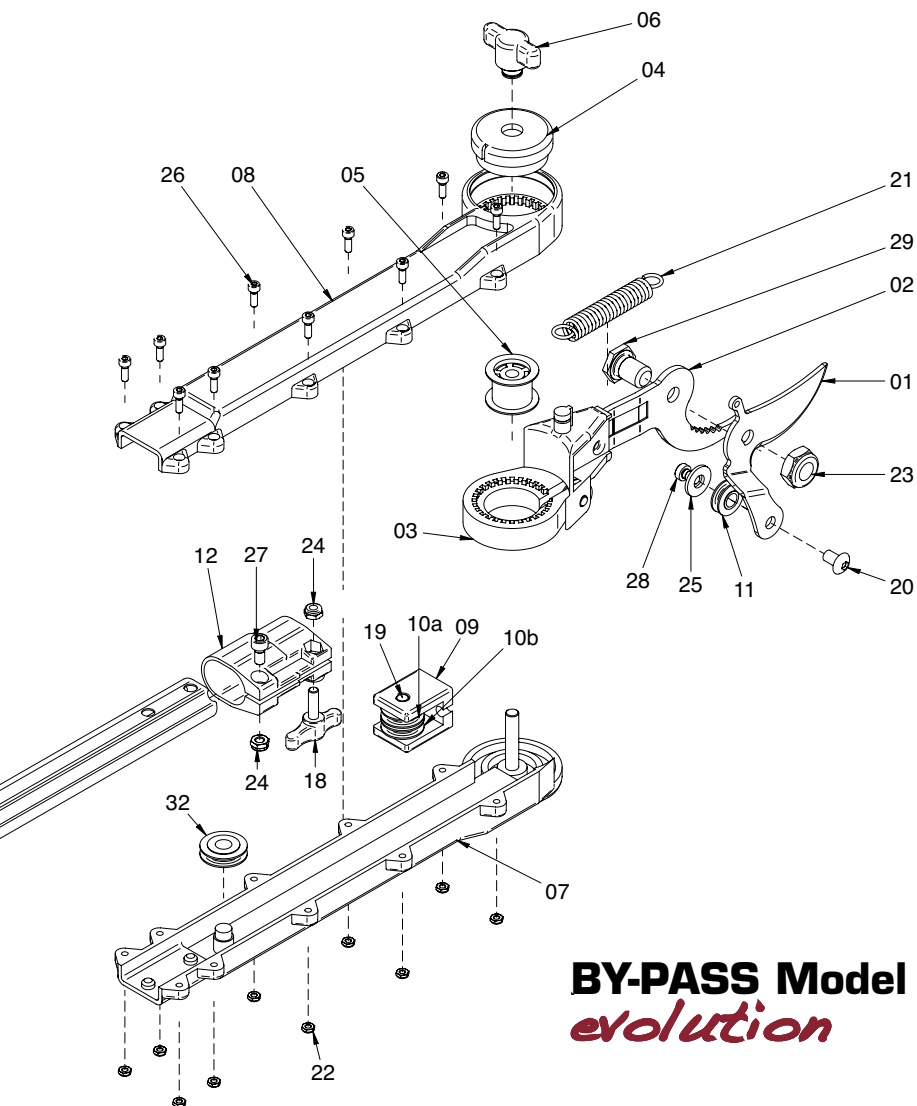
Code	Description	Part in design
761	Anvil support and lever with plastic holder	3+37
754	Anvil blade	34
755	Anvil	35
756	Lever	36
757	Bolt and nut for blade and lever	38+40
757	Bolt and nut for counterblade and anvil support	38+40
758	Bolt and nut for lever and anvil support	39+40



BY-PASS Model *evolution*

UPPER ROPE	PART IN DESIGN: 30
	m 0,55 - Code 730
HANDLE ROPE	PART IN DESIGN: 31
	m 4 - Code 731 m 6,5 Code 740
SAW BLADE WITH BOLT NUT AND WASHER	
	Code 186 - 330 mm BLADE

COMPONENTS OF THE PRUNER SNIPER BY-PASS AND ANVIL *evolution*

Code	Description	Part in design
764	Closure cap with gearing + Wingnut locking plug	4+6
168	Internal wheel for orientation of the head, complete	5
169	Shell cover with screw	7
170	Shell cover with gear	8
44	Pulley holder complete with a rope and pulleys	9+10a+10b+19+30
166	Upper pulley complete	11+20+25+28
138	Tube clamp	12
173	Handle with safety lock	13+42
163	External tube m 2	14
162	Internal tube m 2 with tube end	15+17
165	External tube m 4	14
164	Internal tube m 4 with tube end	15+17
732	External tube m 2 + Internal tube m 2 + tube end	14+15+17
733	External tube m 4 + Internal tube m 4 + tube end	14+15+17
765	Wingnut tube clamp + nut	18+24
728	Spring	21
174	Bolt and nut for shell cover	22+26
167	Bolt and nut for tube clamp	24+27
730	Rope m 0,55 for head	30
731	Rope m 4 for telescopic handle of m 2	31
740	Rope m 6,5 for telescopic handle of m 4	31
161	Large pulley inside the shells	32
182	Lower handle	41

The ARCHMAN TWISTER Lopping Shears with a by-pass blade is an innovative tool that unites a lever and gear system for a geared-down pulley movement that allows branches up to 40 mm in diameter to be cut easily. The inclined adjustable head can be adjusted 250° according to your cutting needs.



ITEM 6

TWISTER LOPPING SHEARS









- HRC 54-56 tempered alloy carbon steel **BLADE**
- HRC 53-55 tempered carbon steel **CONTRA-ROTATING BLADE**
- Tempered carbon steel **LEVER**
- Tempered steel **BOLTS**
- Reinforced fibreglass nylon **PLASTIC BODY**
- Telescopic anodized aluminium **HANDLE** with guided pulley up to 8 m long





OPTION OF APPLYING A CURVED BLADE STARTING FROM 330 mm IN LENGTH

CODE	LENGTH	WEIGHT	CUT Ø	EQUIPPED WITH	PACKING
626	370 mm	970 g	40 mm	7.5 m cord and handle	cardstock
200	4370 mm	2052 g	40 mm	telescopic aluminium handle item 21 - m 4 Ø 32-35 mm, cord and handle	2 piece box
201	6370 mm	2590 g	40 mm	telescopic aluminium handle item 22 - m 6 Ø 28,5-32-35 mm, cord and handle	2 piece box
202	8370 mm	3036 g	40 mm	telescopic aluminium handle item 23 - m 8 Ø 25-28,5-32-35 mm, cord and handle	2 piece box

REPLACEMENT PARTS

BLADE	LEVER	SPRING	BOLT AND NUT	BOLT AND NUT	HEAD HOLDER	FULL SET OF UPPER PULLEYS
 Code 638	 Code 639	 Code 640	 BLADE Code 641	 LEVER Code 642	 Code 753	Code 767

ADAPTER	Code 228 - Ø 25 - per code 196 - 198
	Code 297 - Ø 20,5 - per code 194 - 197
	Code 298 - Ø 32 - per code 195

COUNTERBLADE WITH PLASTIC PART	Code 160
	

CORD	5,5 m Code 643
	7,5 m Code 644
	9 m Code 645

Code 646 BLADE mm 330



TWISTER LOPPING SHEARS



ITEM 21

PROFESSIONAL TELESCOPIC ALUMINIUM POLE

CODE	LENGTH	TUBE Ø	WEIGHT	PACKING
194	4 m	28,5 - 32 mm	1026 g	2 piece box
195	4 m	32 - 35 mm	1080 g	2 piece box

REPLACEMENT PARTS

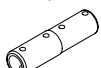
 adapter	Code 228 - Ø mm 25 - per Code 196 - 198
	Code 297 - Ø mm 28,5 - per Code 194 - 197
	Code 298 - Ø mm 32 - per Code 195

ITEM 22

PROFESSIONAL TELESCOPIC ALUMINIUM POLE

CODE	LENGTH	TUBE Ø	WEIGHT	PACKING
196	6 m	25-28,5-32 mm	1450 g	2 piece box
197	6 m	28,5-32-35 mm	1600 g	2 piece box

ITEM 23

PROFESSIONAL TELESCOPIC ALUMINIUM POLE

CODE	LENGTH	TUBE Ø	PESO	PACKING
198	mt. 8	25-28,5-32-35 mm	2036 g	2 piece box







ITEM 24

PROFESSIONAL TELESCOPIC OVAL ALUMINIUM POLE

N. 2 **POLE** sections of pre-anodized electro-welded aluminium
Heat shrinkable rubber **SHEAT**
Double **LOCK SYSTEM** with lever + interlocking bottom

CODE	LENGTH	WEIGHT	PACKING
920	from 1085 mm up to 2000 mm	890 g	2 piece box
870	from 2170 mm up to 4000 mm	1520 g	2 piece box

REPLACEMENT PARTS:

 Code 871	 Code 872	 Code 922	 Code 877	 Code 878	 Code 873
---	---	---	---	---	---

Code 923

Full set of spare parts in blister
(tube locking lever, screw and nut)

Code 924

Full set of spare parts in blister
(bottom, spring, 2 rivets and brass pin)



ARCHMAN

MANIAGO - ITALY

ARCHMAN Professional Pruning Shears are tools especially designed and built for pruning professionals. Made entirely of special steel and coated in plastic, non-slip rubbery material. Polished alloy steel and super sharpness allows for a clean and precise cut.



ITEM 1





INTERCHANGEABLE BLADE SHEARS FOR VINEYARD PRUNING

HRC 54÷56 tempered carbon steel alloy **BLADE** guarantees resistance and an optimal cut
Steel and aluminium **COUNTERBLADE**
Pressed galvanized iron **HANDLE**
coated in plastic material



CODE	LENGTH	WEIGHT	CUT Ø	PACKING
341	230 mm	280 g	24 mm	Blister

REPLACEMENT PARTS:

BLADE	SPRING	BOLT AND NUT	LOCK	WASHER
 Code 20	 Code 13	 Code 293	 Code 360	 Code 547

Code 345

Full set of spare parts in blister
(Blade, spring, bolt and nut)



ITEM 2

INTERCHANGEABLE BLADE SHEARS FOR VINEYARD PRUNING

HRC 54÷56 tempered carbon steel alloy **BLADE** guarantees resistance and an optimal cut





Burnished tempered carbon steel **COUNTERBLADE** and **BLADE HOLDER**
Plastic material **HANDLE**

They can be supplied with a strap and spring hook **ON REQUEST**



CODE	LENGTH	WEIGHT	CUT Ø	PACKING
342	210 mm	230 g	24 mm	Blister

REPLACEMENT PARTS:

BLADE	SPRING	BOLT AND NUT	LOCK
 Code 41	 Code 43	 Code 294	 Code 368

Code 346

Full set of spare parts in blister
(Blade, spring, bolt and nut)



ITEM 3

INTERCHANGEABLE BLADE SHEARS FOR VINEYARD PRUNING







HRC 54÷56 tempered carbon steel alloy **BLADE** guarantees resistance and an optimal cut

Nickel-plated tempered carbon steel **COUNTERBLADE** and **BLADE HOLDER**
Plastic material **HANDLE**

They can be supplied with a strap and spring hook **ON REQUEST**

CODE	LENGTH	WEIGHT	CUT Ø	PACKING
343	210 mm	230 g	24 mm	Blister

REPLACEMENT PARTS:

BLADE	SPRING	BOLT AND NUT	LOCK
			
Code 62	Code 63	Code 295	Code 368

Code 347

Full set of spare parts in blister
(Blade, spring, bolt and nut)



ITEM 4

FIXED BLADE SHEARS FOR VINEYARD PRUNING



HRC 54÷56 burnished tempered carbon steel alloy **BLADE**



Burnished tempered carbon steel **COUNTERBLADE**

Plastic material **HANDLE**

They can be supplied with a strap and spring hook **ON REQUEST**

CODE	LENGTH	WEIGHT	CUT Ø	PACKING
344	210 mm	210 g	24 mm	Blister

REPLACEMENT PARTS:

SPRING	BOLT AND NUT	LOCK
		
Code 63	Code 296	Code 402



ITEM 7T

INTERCHANGEABLE TEFLON BLADE SHEARS WITH SHOCK ABSORBER FOR VINEYARD PRUNING







BLADE entirely Teflon coated to protect against rust and reduces the cutting effort considerably.

Burnished tempered carbon **COUNTERBLADE** and **BLADE HOLDER**

Rubber **SHOCK ABSORBER** to reduce kickbacks.

CODE	LENGTH	WEIGHT	CUT Ø	PACKING
819	mm 220	gr.268	mm 25	Blister

REPLACEMENT PARTS:

BLADE	MOLLA	BULLONE E DADO	FERMADADO
			
Cod. 506	Cod. 43	Cod. 361	Cod. 362

Cod. 824

Full set of spare parts in blister (Teflon blade, spring, bolt and nut, nut lock with screws and shock absorber)



ITEM

10





INTERCHANGEABLE BLADE SHEARS FOR VINEYARD PRUNING

HRC 54÷56 tempered carbon steel alloy **BLADE** guarantees resistance and an optimal cut

Burnished tempered carbon steel **COUNTERBLADE** and **BLADE HOLDER**
Ergonomic, non-slip, rubbery plastic **HANDLE**

CODE	LENGTH	WEIGHT	CUT Ø	PACKING
525	220 mm	250 g	24 mm	Blister

REPLACEMENT PARTS:

BLADE	SPRING	BOLT AND NUT	NUT LOCK WITH SCREW	LOCK
				
Code 484	Code 485	Code 361	Code 362	Code 511

Code 458

Full set of spare parts in blister
(Blade, spring, bolt and nut, nut lock with screws)



ITEM

10T





INTERCHANGEABLE TEFLON BLADE SHEARS FOR VINEYARD PRUNING

HRC 54÷56 tempered carbon steel alloy **BLADE** guarantees resistance and an optimal cut. Blade entirely Teflon coated to protect against rust and noticeably ease shearing force.

Burnished tempered carbon steel **COUNTERBLADE** and **BLADE HOLDER**
Ergonomic, non-slip, rubbery plastic **HANDLE**

CODE	LENGTH	WEIGHT	CUT Ø	PACKING
500	220 mm	250 g	25 mm	Blister

REPLACEMENT PARTS:

BLADE	SPRING	BOLT AND NUT	NUT LOCK WITH SCREW	LOCK
				
Code 506	Code 485	Code 361	Code 362	Code 511

Code 459

Full set of spare parts in blister
(Teflon blade, spring, bolt and nut, nut lock with screws)

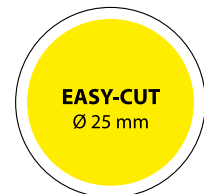
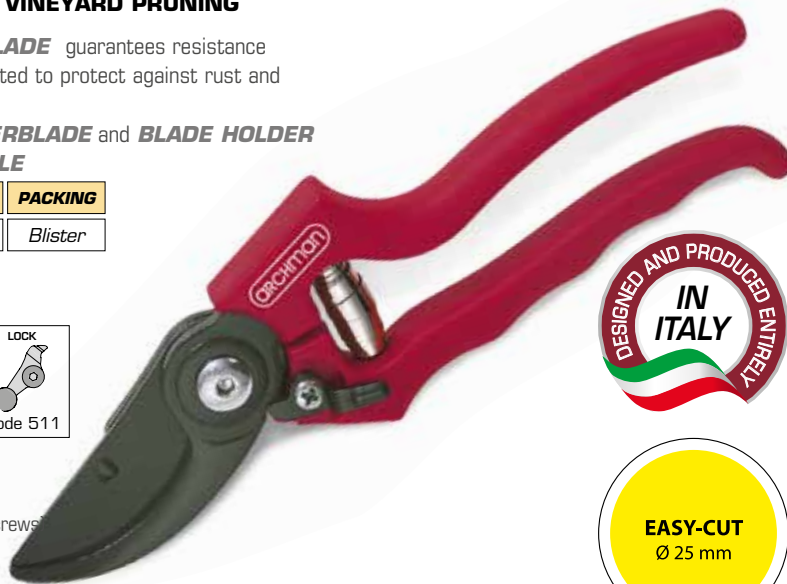

TRADEMARK MODEL

New patented built-in system to easily replace the blade





ITEM **12**





INTERCHANGEABLE SHORT BLADE SHEARS FOR VINEYARD PRUNING

HRC 54÷56 tempered carbon steel alloy **BLADE** guarantees resistance and an optimal cut.

Burnished tempered carbon steel **COUNTERBLADE** and **BLADE HOLDER**
Ergonomic, non-slip, rubbery plastic **HANDLE**

CODE	LENGTH	WEIGHT	CUT Ø	PACKING
415	190 mm	200 g	24 mm	Blister

REPLACEMENT PARTS:

BLADE	SPRING	BOLT AND NUT	NUT LOCK WITH SCREW	LOCK
				
Code 358	Code 63	Code 361	Code 362	Code 511

Cod. 363

Full set of spare parts in blister
(Blade, spring, bolt and nut, nut lock with screws)



ITEM **12T**





INTERCHANGEABLE SHORT TEFLON BLADE SHEARS FOR VINEYARD PRUNING

HRC 54÷56 tempered carbon steel alloy **BLADE** guarantees resistance and an optimal cut. Blade entirely Teflon coated to protect against rust and noticeably ease shearing force.

Burnished tempered carbon steel **COUNTERBLADE** and **BLADE HOLDER**
Ergonomic, non-slip, rubbery plastic **HANDLE**

CODE	LENGTH	WEIGHT	CUT Ø	PACKING
416	190 mm	200 g	25 mm	Blister

REPLACEMENT PARTS:

BLADE	SPRING	BOLT AND NUT	NUT LOCK WITH SCREW	LOCK
				
Code 359	Code 63	Code 361	Code 362	Code 511

Code 364

Full set of spare parts in blister
(Teflon blade, spring, bolt and nut, nut lock with screws)

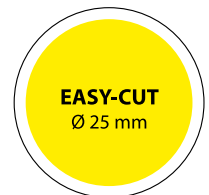

ARCHMAN

MANIAGO - ITALY

HYBRID by ARCHMAN is the new teflon coated curved blade pruning shears. The counter-blade is made of ultra-resistant aluminum alloy that makes the scissors very light, only 180 gr. Made of special tempered steels with an ergonomic non-slip grip.



ITEM 26H

ANVIL SHEARS CURVED TEFLON BLADE INTERCHANGEABLE BLADE AND ALUMINUM ANVIL

HRC 54÷56 tempered carbon steel alloy **BLADE** guarantees resistance and an optimal cut.

Blade entirely Teflon coated to protect against rust and noticeably ease shearing force

Aluminum alloy curved **ANVIL**







HRC 48÷50 burnished tempered carbon steel **BLADE-HOLDER**

Ergonomic, non-slip, rubbery plastic **HANDLE**

CODE	LENGTH	WEIGHT	CUT Ø	PACKING
910	210 mm	180 g	25 g	Blister



REPLACEMENT PARTS:

BLADE	PLASTICATED ALUMINUM ANVIL	SPRING	BOLT AND NUT	NUT LOCK WITH SCREW	LOCK	2 NYLON BUSHING
						
Code 231	Code 911	Code 63	Code 233	Code 362	Code 180	Code 912

Code 921 - Full set of spare parts in blister (curved teflon blade, spring, bolt and nut, 2 nylon bushing, lock washer with screw)

ITEM 9T

ANVIL SHEARS STRAIGHT TEFLON BLADE

HRC 54÷56 tempered carbon steel alloy **BLADE** guarantees resistance and an optimal cut. Blade entirely Teflon coated to protect against rust and significantly reduce the shears stress

HRC 54÷56 burnished tempered carbon steel alloy **ANVIL** coated in nylon6 VTR30%







HRC 48÷50 burnished tempered carbon steel **ANVIL-HOLDER** and **BLADE-HOLDER**

Ergonomic, non-slip, rubbery plastic **HANDLE**

CODE	LENGTH	WEIGHT	CUT Ø	PACKING
176	210 mm	250 g	25 mm	Blister



REPLACEMENT PARTS:

BLADE	SPRING	BOLT AND NUT	NUT LOCK WITH SCREW	LOCK	PLASTIC ANVIL
					
Code 181	Code 63	Code 179	Code 362	Code 180	Code 178

Code 183 - Full set of spare parts in blister (teflon blade, anvil, spring, bolt and nut, lock washer with screw)



ORCHMAN double-hedge shears are perfect for pruning fruit trees, the two cutting blades make a clean cut in order to avoid damage to the plants. **Item 17** is the traditional double-edge shears made entirely of tempered forged carbon steel and covered with injected rubbery plastic that becomes soft and non-slip to the touch. **Item 19** made with tempered carbon steel handles covered with soft and non-slip rubber, while blades are made with a special alloy carbon steel to keep the edge and extend the life of the cut. The ergonomic handles and light help to reduce the fatigue of the user's hand. Blades are easier interchangeable or reversed to permit also to the lefty and easier cut. Both models are equipped with a micrometer screw that permit easier to adjust the closing point of the blades so that the edges match up perfectly for a precise cut.





ITEM 17

FORGED DOUBLE-EDGED SHEARS FOR ORCHARD PRUNING

HRC 54÷56 C50 forged steel **BLADE**
Non-slip, rubbery plastic **HANDLE**

CODE	LENGTH	WEIGHT	CUT Ø	PACKING
501	210 mm	290 g	24 mm	Blister

REPLACEMENT PARTS:

SPRING	BOLT AND NUT	NUT LOCK WITH SCREW
		
Code 63	Code 423	Code 424

Code 440 - Full set of spare parts in blister (Spring, nut and bolt, nut lock with screws)



NUT LOCK







ITEM 19

DOUBLE HEDGE SHEARS

HRC 54÷56 tempered carbon steel alloy **BLADES** guarantee resistance and an optimal cut
HRC 48÷50 tempered and burnished **BLADES-HOLDER**
Ergonomic, non-slip, rubbery plastic **HANDLE**

CODE	LENGTH	WEIGHT	CUT Ø	HANDLE COULOR	PACKING
191	mm 210	gr. 290	mm 24	Bordeaux	Blister

REPLACEMENT PARTS:

BLADES	SPRING	BOLT AND NUT	ADJUST LOCK SCREW	LOCK
				
Code 211	Code 63	Code 212	Code 213	Code 180

Code 214 - Full set of spare parts in blister for BORDEAUX HANDLES (couple of blades, spring, bolt and nut, adjust lock screw)







ITEM 19T

DOUBLE HEDGE SHEARS TELFON BLADE

BLADE entirely Teflon coated to protect against rust and noticeably ease shearing force
HRC 54÷56 tempered carbon steel alloy **BLADES** guarantee resistance and an optimal cut
HRC 48÷50 tempered and burnished **BLADES-HOLDER**
Ergonomic, non-slip, rubbery plastic **HANDLE**

CODE	LENGTH	WEIGHT	CUT Ø	HANDLE COULOR	PACKING
223	mm 210	gr. 290	mm 25	Bordeaux	Blister

REPLACEMENT PARTS:

TEFLON BLADES	SPRING	BOLT AND NUT	ADJUST LOCK SCREW	LOCK
				
Code 225	Code 63	Code 212	Code 213	Code 180

Code 226 - Full set of spare parts in blister for BORDEAUX HANDLES (couple of teflon blades, spring, bolt and nut, adjust lock screw)



EASY-CUT
Ø 25 mm



The forged aluminium alloy pruning shears are ideal for all types of cut. Light, robust and ergonomic



ITEM 133

FORGED ALUMINIUM BY-PASS PRUNING SHEARS INTERCHANGEABLE BLADE

BLADE in carbon tempered steel HRC 55÷56





COUNTERBLADE AND BLADE HOLDER in forged aluminium alloy

HANDLE in forged aluminium alloy coated in rubbery plastic with rubber shock absorber and closure to protect the wrist

TOOTHED NUT for easy and precise adjustment of the blade and counterblade

CODE	LENGTH	WEIGHT	CUT Ø	PACKING
674	215 mm	279 g	22 mm	Blister

REPLACEMENT PARTS:

BLADE	SPRING	BOLT, NUT AND NUT-LOCK	LOCK	SHOCK ABSORBER
 Code 671	 Code 63	 Code 688	 Code 689	 Code 880

Code 690

Full set of spare parts in blister (blade, spring, nut and nut-lock, lock with screw)



ITEM 134

FORGED ALUMINIUM BY-PASS PRUNING SHEARS INTERCHANGEABLE BLADE

BLADE in carbon tempered steel HRC 55÷56

BLADE HOLDER in forged aluminium alloy





COUNTERBLADE in carbon tempered steel HRC 54÷55

HANDLE in forged aluminium alloy coated in rubbery plastic with rubber shock absorber and closure to protect the wrist

TOOTHED NUT for easy and precise adjustment of the blade and counterblade

CODE	LENGTH	WEIGHT	CUT Ø	PACKING
675	210 mm	248 g	22 mm	Blister

REPLACEMENT PARTS:

BLADE	SPRING	BOLT, NUT AND NUT-LOCK	LOCK	SHOCK ABSORBER
 Code 691	 Code 63	 Code 241	 Code 720	 Code 880

Code 692

Full set of spare parts in blister (blade, spring, nut and nut-lock, lock with screw)

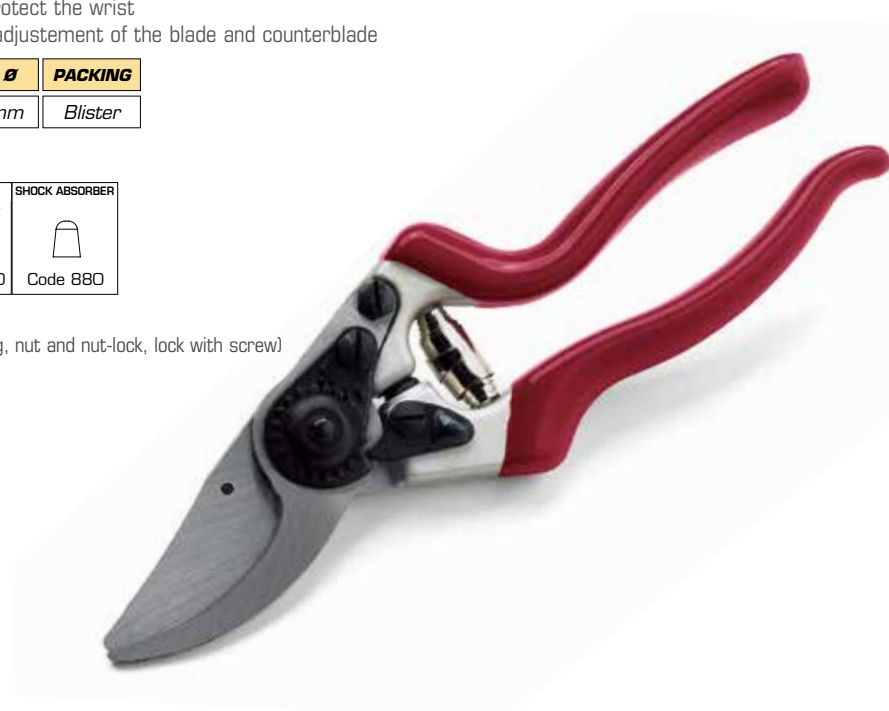



ITEM **160**





FORGED ALUMINIUM BY-PASS PRUNING SHEARS INTERCHANGEABLE BLADE



BLADE in carbon tempered steel HRC 55÷56
BLADE HOLDER in forged aluminium alloy
COUNTERBLADE in carbon tempered steel HRC 54÷55
HANDLE in forged aluminium alloy coated in rubbery plastic with rubber shock absorber and closure to protect the wrist
TOOTHED NUT for easy and precise adjustment of the blade and counterblade

CODE	LENGTH	WEIGHT	CUT Ø	PACKING
782	215 mm	255 g	22 mm	Blister

REPLACEMENT PARTS:

BLADE	SPRING	BOLT, NUT AND NUT-LOCK	LOCK	SHOCK ABSORBER
 Code 784	 Code 63	 Code 787	 Code 789	 Code 880

Code 792
 Full set of spare parts in blister
 (blade, spring, nut and nut-lock, lock with screw)



ITEM **161**





FORGED ALUMINIUM BY-PASS PRUNING SHEARS INTERCHANGEABLE SHORT BLADE



BLADE in carbon tempered steel HRC 55÷56
BLADE HOLDER in forged aluminium alloy
COUNTERBLADE in carbon tempered steel HRC 54÷55
HANDLE in forged aluminium alloy coated in rubbery plastic with rubber shock absorber and closure to protect the wrist
TOOTHED NUT for easy and precise adjustment of the blade and counterblade

CODE	LENGTH	WEIGHT	CUT Ø	PACKING
783	200 mm	230 g	22 mm	Blister

REPLACEMENT PARTS:

BLADE	SPRING	BOLT, NUT AND NUT-LOCK	LOCK	SHOCK ABSORBER
 Code 785	 Code 63	 Code 788	 Code 790	 Code 880

Code 793
 Full set of spare parts in blister (blade, spring, nut and nut-lock, lock with screw)



ARCHMAN

MANIAGO - ITALY

ARCHMAN *Professional Grape Harvesting Shears* are light and manageable tools suitable for harvesting grapes or cutting flowers.





ITEM 16 stainless steel FLOWER CUTTING SHEARS



HRC 52 tempered stainless steel **BLADE**
Plastic **HANDLE**

CODE	LENGTH	WEIGHT	CUT Ø	PACKING
696	190 mm	109 g	14 mm	Blister

REPLACEMENT PARTS:

SPRING	BOLT AND NUT
	
Code 272	Code 409





ITEM 18 stainless steel GRAPE HARVESTING SHEARS



HRC 52 tempered stainless steel **BLADE**
Plastic **HANDLE**

CODE	LENGTH	WEIGHT	PACKING
707	160 mm	62 g	Blister without strap

REPLACEMENT PARTS:

SPRING	BOLT AND NUT
	
Code 87	Code 412



AVAILABLE
WITH OR WITHOUT
STRAP



ITEM 20 stainless steel GRAPE HARVESTING SHEARS



HRC 52 tempered stainless steel **BLADE**
Plastic **HANDLE**

CODE	LENGTH	WEIGHT	PACKING
713	190 mm	82 g	Blister without strap

REPLACEMENT PARTS:

SPRING	BOLT AND NUT
	
Cod. 272	Cod. 409



Shears perfect for vineyards, orchards and flower cutting. Available with both straight blades that adjust according to their use. Grip coated in plastic for a comfortable hold.

ITEM 116 stainless steel

STRAIGHT BLADE VINEYARD AND GARDENING SHEARS



Straight, stainless steel **BLADE**
Steel **GRIP** coated in plastic material

CODE	LENGTH	WEIGHT	PACKING
559	190 mm	110 g	Blister

REPLACEMENT PARTS:

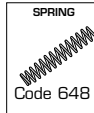

ITEM 117 stainless steel

CURVED BLADE VINEYARD AND GARDENING SHEARS



Curved, stainless steel **BLADE**
Steel **GRIP** coated in plastic material

CODE	LENGTH	WEIGHT	PACKING
633	190 mm	110 g	Blister

REPLACEMENT PARTS:

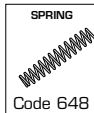

CURVED BLADE



ITEM 118 stainless steel

STRAIGHT BLADE VINEYARD AND GARDENING SHEARS



Straight, stainless steel **BLADE**
Steel **GRIP** coated in plastic material

CODE	LENGTH	WEIGHT	PACKING
634	170 mm	109 g	Blister

REPLACEMENT PARTS:

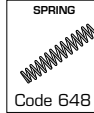

ITEM 119 stainless steel

CURVED BLADE VINEYARD AND GARDENING SHEARS



Curved, stainless steel **BLADE**
Steel **GRIP** coated in plastic material

CODE	LENGTH	WEIGHT	PACKING
635	170 mm	109 g	Blister

REPLACEMENT PARTS:

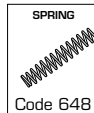

CURVED BLADE



ITEM 126 stainless steel

GARDEN AND GRAPE STAINLESS STEEL SHEARS BY-PASS BLADE



By-pass, stainless steel **BLADE**
HANDLE in steel coated with plastic material

CODE	LENGTH	WEIGHT	PACKING
768	180 mm	115 g	Blister

REPLACEMENT PARTS:

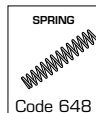

ARCHMAN

MANIAGO - ITALY

Grass shears, perfect for trimming lawn borders, are available in two models.



ITEM

156

SWIVEL GRASS SHEARS



360° adjustable **BLADE** in tempered steel
Upper blade coated in non-stick material
Chromed lower blade
Plastic **GRIP**

CODE	WEIGHT	PACKING
207	330 g	Blister



ITEM

85

FIXED GRASS SHEARS



Burnished tempered steel **BLADE**
Plastic coated **GRIP**

CODE	WEIGHT	PACKING
553	262 g	Envelope



The ARCHMAN garden shears are available: ratchet, for cutting extremely hard branches as this type of system allows to distribute cutting effort; by-pass or curved anvil blade equipped with handles with non-slip rubber inserts.



ITEM

88

FIXED CURVED BLADE RATCHET SHEARS

Interchangeable curved **BLADE** in HRC 53÷54 tempered steel, entirely coated in non-stick material to noticeably reduce the shearing force.

Aluminium **CONTRA-ROTATING BLADE**
Aluminium **GRIP** with rubber coating

CODE	WEIGHT	CUT Ø	PACKING
560	223 g	24 mm	Blister



RATCHET SYSTEM



Adjustable shears with aluminium fixed handles or telescopic handles "Cut and hold" system to cut flowers, fruit or small hard-to-reach branches. Ergonomic aluminium grip coated in rubbery material. Equipped with a practical close



ITEM **106**

SWINGING LONG REACH PRUNER FIXED ALUMINIUM HANDLE



Steel **BLADE** coated in non-stick material
Tempered steel **CONTRA-ROTATING BLADE**
Fixed anodized aluminium **POLE**

CODE	LENGTH	WEIGHT	PACKING	PACKAGE
578	mm 830	497 g	Blister	Box of 4 pcs.

REPLACEMENT PARTS: Code 581
Complete series of steel replacement blades (Blade, contra-rotating blade, screw and nut)

Code 805
HANDLE

Code 1011
HEAD JUNCTION

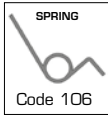

ITEM **107**

SWINGING LONG REACH PRUNER TELESCOPIC ALUMINIUM HANDLE



Steel **BLADE** coated in non-stick material
Tempered steel **CONTRA-ROTATING BLADE**
Telescopic anodized aluminium **POLE**

CODE	LENGTH	WEIGHT	PACKING	PACKAGE
715	from mm 1370 to mm 2070	943 g	Blister	Box of 2 pcs.

REPLACEMENT PARTS: Code 581
Complete series of steel replacement blades (Blade, contra-rotating blade, screw and nut)

Code 805
HANDLE

Code 1011
HEAD JUNCTION

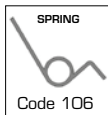

ITEM **108**

SWINGING LONG REACH PRUNER TELESCOPIC ALUMINIUM HANDLE



Steel **BLADE** coated in non-stick material
Tempered steel **CONTRA-ROTATING BLADE**
Telescopic anodized aluminium **POLE**

CODE	LENGTH	WEIGHT	PACKING	PACKAGE
716	from mm 1840 to mm 3090	1160 g	Blister	Box of 2 pcs.

REPLACEMENT PARTS: Code 581
Complete series of steel replacement blades (Blade, contra-rotating blade, screw and nut)

Code 805
HANDLE

Code 1011
HEAD JUNCTION

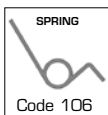

ITEM 106 ITEM 107 ITEM 108

REINFORCED FIBREGLOSS NYLON HANDLE

LONG REACH PRUNER ALUMINIUM HANDLE



ARCHman

MANIAGO - ITALY



ARCHman

MANIAGO - ITALY

ARCHman
MANIAGO - ITALY

BATTERIA
16.8V 2.6AH

CE
RECYCLING SYMBOLS
LITHIUM ION BATTERY SYMBOLS

ARCHman
POMPE DA PISTONAZZA
A BATTERIA (E.DI)
16.8V
2.6AH
CE
RECYCLING SYMBOLS
LITHIUM ION BATTERY SYMBOLS



ITEM

13

LOPPERS SHEARS BY-PASS BLADE



HRC 54-56 tempered carbon steel curved **BLADE**, particularly resistant to wear and tear
 HRC 52-54 for tempered carbon steel **COUNTERBLADE**
 Ergonomic, non-slip rubbery plastic **GRIP**
 Different length, anodized aluminium **HANDLES**
 Tempered steel **BOLT** with nut locks
 Rubberly plastic **SHOCK ABSORBERS** to reduce backlash

CODE	LENGTH	WEIGHT	CUT Ø	PACKING
432	60 cm	970 g	40 mm	Plastic case
420	80 cm	1150 g	40 mm	Plastic case
419	100 cm	1300 g	40 mm	Plastic case

REPLACEMENT PARTS:

BLADE	COUNTERBLADE	BOLT AND NUT	NUT LOCK	SHOCK ABSORBERS
Code 434	Code 614	Code 502	Code 509	Code 622
BLADE WITH HANDLE				
		Code 610 60 cm Code 612 80 cm Code 613 100 cm		
COUNTERBLADE WITH HANDLE				
		Code 616 60 cm Code 618 80 cm Code 619 100 cm		



Code 435
 Full set of spare parts in blister
 (shock absorbers, nut and bolt,
 lock washer with screw)



LOPPERS

ITEM

15

LOPPERS SHEARS ANVIL BLADE



HRC 54-56 tempered carbon steel straight **BLADE**, resistant to intense shearing force with a polished convex wire to cut through dry branches better.
 Tempered carbon steel **COUNTERBLADE**
 Nylon **HINGES** reinforced with fibreglass
 Tempered steel **LEVER**
 Ergonomic, non-slip rubbery plastic **GRIP**
 Anodized aluminium **HANDLES**
 Tempered steel **BOLTS**

CODE	LENGTH	WEIGHT	CUT Ø	PACKING
88	80 cm	1260 g	40 mm	Plastic case

REPLACEMENT PARTS:

BLADE	STEEL LEVER	NYLON COUNTERBLADE	STEEL COUNTERBLADE	BOLT AND NUT
Code 289	Code 548	Code 290	Code 291	Code 348 Code 597 Code 598 Code 599 Code 600
LEVER WITH HANDLE				
			Code 607 80 cm	
BLADE WITH HANDLE				
			Code 603 80 cm	



Code 292
 Full spare parts bolts and nuts in blister
 (5 bolts and nuts)

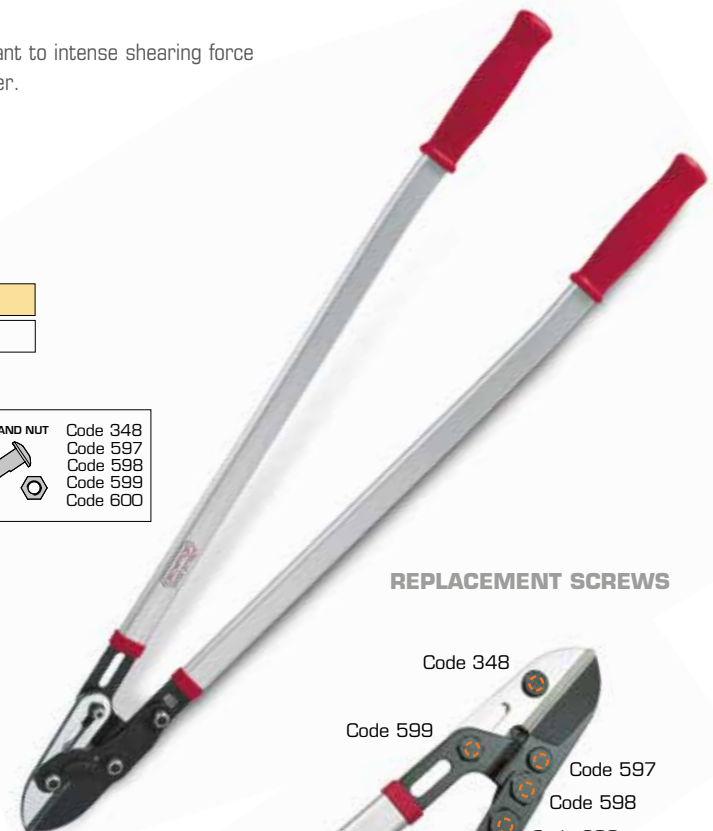

REPLACEMENT SCREWS

Code 348
 Code 599
 Code 597
 Code 598
 Code 600



ITEM 28T

LOPPERS SHEARS ANVIL CURVED TEFLON BLADE

HRC 54÷56 tempered carbon steel alloy **BLADE** guarantees resistance and an optimal cut; Blade entirely Teflon coated to protect against rust and to reduce the effort of cut **ANVIL** in aluminum anodized with burnished and tempered carbon steel core HRC 48÷50 burnished tempered carbon steel **BLADE-HOLDER** and **COUNTERBLADE** Aluminum anodized **HANDLES** covered with non-slip rubber plastic Tempered and burnished steel **BOLT**



CODE	LENGTH	WEIGHT	CUT Ø	PACKING
245	cm 60	gr. 810	mm 40	Plastic case
247	cm 80	gr. 960	mm 40	Plastic case
248	cm 100	gr. 1120	mm 40	Plastic case

SPARE PARTS:

TEFLON BLADE	STEEL COUNTERBLADE	STEEL BLADE-HOLDER	ALUMINIUM ANVIL - SCREWS	BOLT AND NUT	ADJUST LOCK SCREW
Code 249	Code 250	Code 251	Code 929	Code 253	Code 254
BLADE-HOLDER WITH HANDLE			Code 255 cm 60 Code 257 cm 80 Code 258 cm 100		
COUNTERBLADE WITH HANDLE			Code 259 cm 60 Code 261 cm 80 Code 262 cm 100		

Code 263

Full set of spare parts in blister (teflon blade, aluminium anvil and screws, bolt and nut, adjust lock screw)



ITEM 29T

LOPPERS SHEARS ANVIL CURVED TEFLON BLADE WITH LEVERAGE SYSTEM

HRC 54÷56 tempered carbon steel alloy **BLADE** guarantees resistance and an optimal cut; Blade entirely Teflon coated to protect against rust and to reduce the effort of cut **ANVIL** in aluminum anodized with burnished and tempered carbon steel core Tempered and burnished steel **LEVER** HRC 48÷50 tempered and burnished carbon steel **BLADE-HOLDER** Aluminum anodized **HANDLES** covered with non-slip rubber plastic Tempered and burnished steel **BOLTS**



CODE	LENGTH	WEIGHT	CUT Ø	PACKING
913	cm 60	gr. 880	mm 40	Plastic case
914	cm 80	gr. 1030	mm 40	Plastic case
915	cm 100	gr. 1190	mm 40	Plastic case

SPARE PARTS:

TEFLON BLADE	STEEL COUNTERBLADE	STEEL BLADE-HOLDER	STEEL LEVER	ALUMINIUM ANVIL - SCREWS	BOLT AND NUT
Code 925	Code 926	Code 927	Code 928	Code 929	Code 930
LEVER WITH HANDLE			Code 954 cm 60 Code 955 cm 80 Code 956 cm 100		
COUNTERBLADE WITH HANDLE			Code 951 cm 60 Code 952 cm 80 Code 953 cm 100		
					COUNTERBLADE BOLT AND NUT Code 931
					LEVER BOLT AND NUT Code 932

Code 934

Full set of spare parts in blister (teflon blade, aluminium anvil and screws, 3 bolts and nuts)



The hedge cutter shears with aluminium handles is available in two versions:

Undulated blade with telescopic handle covered in non-slip soft plastic; the press-button system to extend the handle guarantees secure and stable block;

Straight blade with lopper use particularly ideal for hedge cutting with the possibility of cutting large branches up to 22 mm in diameter as it has a specific side blade.



ITEM 141

HEDGE SHEARS UNDULATED BLADE ALUMINIUM TELESCOPIC HANDLE



BLADES undulated in carbon tempered steel HRC 50÷52

The top blade is entirely teflon coated, the lower chromed blade has a lever system that makes cutting smoother and less tiring

HANDLE telescopic in anodized aluminium

HANDLE in non-slip rubber plastic material

CODE	LENGTH	WEIGHT	PACKING
682	650 mm	1250 g	Envelope
	710 mm		
	775 mm		
	840 mm		

REPLACEMENT PARTS:

BOLT	WASHER	LOCK BOTTON
Code 184	Code 185	Code 222



ITEM 142

HEDGE SHEARS AND LOPPER USE STRAIGHT BLADE AND ALUMINIUM HANDLE



BLADES smooth in carbon tempered steel HRC 50-52 fitted with side blades for cutting larger branches up to 22 mm in diameter

HANDLE in aluminium

HANDLE in non-slip rubber plastic material

CODE	LENGTH	WEIGHT	PACKING
683	570 mm	710 g	Plastic case



Side blades for cutting large branches

ARCHMAN hedge trimmers.
 Entirely tempered carbon steel blade guarantees resistance and an optimal cut.
 Perfect for trimming hedges or ornamental art work.



ITEM 25

HEDGE SHEARS ALUMINIUM HANDLE

HRC 52-54 serrated burnished tempered carbon steel **BLADE**
 Aluminium **HANDLE**
 Rubber **SHOCK ABSORBER** to reduce backlash
 Tempered steel **BOLT**



CODE	LENGTH	WEIGHT	PACKING
218	550 mm	972 g	Plastic case
199	650 mm	1000 g	Plastic case
219	750 mm	1073 g	Plastic case

REPLACEMENT PARTS:

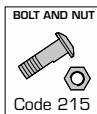

The ARCHMAN pruning saws are equipped with an interchangeable fixed blade, plastic handle and sheath.
Chromed blade with TRI-EDGS sharpening for a faster and lighter cut.

ITEM 178

PRUNING SAW WITH SHEATH

Chromed tempered steel **BLADE**

Plastic **HANDLE**

CODE	BLADE LENGHT	WEIGHT	PACKING
958	mm 240	gr. 120	Bulk

SPARE PARTS: Cod. 959 BLADE mm 240



ITEM 174

PRUNING SAW WITH SHEATH

Chromed tempered steel **BLADE**

Plastic **HANDLE**

CODE	BLADE LENGHT	WEIGHT	PACKING
857	mm 270	gr. 130	Bulk

SPARE PARTS: Cod. 858 BLADE mm 270



ITEM 175

PRUNING SAW WITH SHEATH

Chromed tempered steel **BLADE**

Plastic **HANDLE**

CODE	BLADE LENGHT	WEIGHT	PACKING
859	mm 300	gr. 140	Bulk

SPARE PARTS: Cod. 860 BLADE mm 300



ITEM 176

PRUNING SAW WITH SHEATH

Chromed tempered steel **BLADE**

Plastic **HANDLE**

CODE	BLADE LENGHT	WEIGHT	PACKING
861	mm 350	gr. 150	Bulk

SPARE PARTS: Cod. 862 BLADE mm 350



ARCHMAN closable blade pruning saws are equipped with an interchangeable straight blade and auto-lock button. Extremely sharp tempered teeth for a quick and clean cut. Anatomically non-slip rubber coated handle.



ITEM 58

FOLDING PRUNING SAW



HRC 50÷52 tempered chrome **BLADE**
Plastic **GRIP**

CODE	BLADE LENGTH	WEIGHT	PACKING
381	140 mm	168 g	Blister

REPLACEMENT PARTS:

Code 390 BLADE 140 mm



Cod. 962 HANDLE mm 140

ITEM 57

FOLDING PRUNING SAW



HRC 50÷52 tempered chrome **BLADE**
Plastic **GRIP**

CODE	BLADE LENGTH	WEIGHT	PACKING
380	180 mm	218 g	Blister

REPLACEMENT PARTS:

Code 389 BLADE 180 mm



Cod. 961 HANDLE mm 180

ITEM 56

FOLDING PRUNING SAW



HRC 50÷52 tempered chrome **BLADE**
Plastic **GRIP**

CODE	BLADE LENGTH	WEIGHT	PACKING
379	210 mm	242 g	Blister

REPLACEMENT PARTS:

Code 388 BLADE 210 mm



Cod. 960 HANDLE mm 210



AUTOLOCK
BUTTON



STRENGTH
HRC 50-52



CHROME COATINGS
Not only to prevent rusting
but also for a moving cut

TRI-EDGES
For a quick and light cut



ARCHMAN

MANIAGO - ITALY

ARCHMAN fixed blade pruning saws are equipped with an interchangeable straight blade and a sheath with a strap. Extremely sharp tempered teeth for a quick and clean cut. Anatomical aluminium handle recoated in non-slip rubber.



ITEM 110

PRUNING SAW WITH SHEATH

HRC 50-52 tempered chrome **BLADE**
Aluminium **GRIP** coated in non-slip rubber material

CODE	BLADE LENGTH	WEIGHT
624	210 mm	200 g

REPLACEMENT PARTS: Code 625 - 210 mm BLADE



ITEM 59

PRUNING SAW WITH SHEATH

HRC 50-52 tempered chrome **BLADE**
Aluminium **GRIP** coated in non-slip rubber material

CODE	BLADE LENGTH	WEIGHT
382	240 mm	210 g

REPLACEMENT PARTS: Code 391 - 240 mm BLADE



ITEM 60

PRUNING SAW WITH SHEATH

HRC 50-52 tempered chrome **BLADE**
Aluminium **GRIP** coated in non-slip rubber material

CODE	BLADE LENGTH	WEIGHT
383	270 mm	220 g

REPLACEMENT PARTS: Code 392 - 270 mm BLADE



ITEM 66

PRUNING SAW WITH SHEATH

HRC 50-52 tempered chrome **BLADE**
Aluminium **GRIP** coated in non-slip rubber material

CODE	BLADE LENGTH	WEIGHT
426	300 mm	230 g

REPLACEMENT PARTS: Code 427 - 300 mm BLADE



ITEM 67

PRUNING SAW WITH SHEATH

HRC 50-52 tempered chrome **BLADE**
Aluminium **GRIP** coated in non-slip rubber material

CODE	BLADE LENGTH	WEIGHT
443	350 mm	240 g

REPLACEMENT PARTS: Code 442 - 350 mm BLADE



ARCHMAN pruning saws with umbrella handle and an interchangeable straight blade has special extremely sharp tempered teeth for a quick and clean cut. Steel tube handle.

ARCHMAN pruning saws with an interchangeable curved blade and sheath have special extremely sharp tempered teeth for a quick and clean cut. Anatomical aluminium handle coated in non-slip rubber.



ITEM 61
UMBRELLA HANDLE PRUNING SAW

HRC 50÷52 tempered chrome **BLADE**
Steel tube **GRIP**

CODE	BLADE LENGTH	WEIGHT	PACKING
431	300 mm	245 g	Cardboard

REPLACEMENT PARTS: Code 393 - 300 mm BLADE



ITEM 68
UMBRELLA HANDLE PRUNING SAW

HRC 50÷52 tempered chrome **BLADE**
Steel tube **GRIP**

CODE	BLADE LENGTH	WEIGHT	PACKING
441	350 mm	255 g	Cardboard

REPLACEMENT PARTS: Code 192 - 350 mm BLADE



ITEM 78
CURVED PRUNING SAW WITH SHEATH

HRC 50÷52 tempered chrome **BLADE**
Aluminium **GRIP** coated with non-slip rubber material

CODE	BLADE LENGTH	WEIGHT	PACKING
523	330 mm	265 g	Cardboard

REPLACEMENT PARTS: Code 595 - 330 mm BLADE



ARCHMAN pruning saws with telescopic poles with curved blades have special extremely sharp, tempered teeth for a quick and clean cut. Steel tube handle. Can be used with telescopic poles.



ITEM **109**

CURVED BLADE PRUNING SAW WITH SHEATH

HRC 50÷52 tempered chrome curved **BLADE**
Steel tube **GRIP** to apply to aluminium telescopic poles from 4-6-8 m

CODE	BLADE LENGTH	WEIGHT	PACKING
596	460 mm	388 g	Cardboard



ITEM **69**

CURVED BLADE PRUNING SAW

HRC 50÷52 tempered chrome curved **BLADE**
Steel tube **GRIP** to apply to aluminium telescopic poles from 4-6-8 m

CODE	BLADE LENGTH	WEIGHT	PACKING
444	330 mm	314 g	Cardboard



SEPARATE TELESCOPIC POLES

SAWS

CHROME COATING

Not only to prevent rusting but also for a moving cut

STRENGTH
HRC 50-52

TRI-EDGES

For a quick and light cut



BUTTERFLY BROOM LEAVES ITEM 177 perfect for cleaning gardens and courtyards even of large dimensions, it makes work easier and faster, saving time. Made of high impact material, it is super light, flexible and ultra resistant.

MEMORY BROOM LEAVES ITEM 173 with plastic memory that allows the teeth, even if bent or trampled, to always return to their position and not break. Equipped with a universal attachment for all types of handles, the Archman compatible fiber glass handle is item 169. Supplied with display box.



ITEM 155

STEEL RAKE WITH PLASTIC SUPPORT

CODE	WIDTH	N. TEETH	WEIGHT	PACKING	PACKAGE
206	460 mm	25	320 g	Bulk	Box of 12 pcs.



ITEM 169

FIBER GLASS HANDLE WITH RING FOR RAKES AND BROOMS

CODE	LENGHT	WEIGHT	PACKING	PACKAGE
627	1500 mm	475 g	Plastic case	Box of 12 pcs.



ITEM 177

BUTTERFLY BROOM LEAVES HANDLES ONLY FOR HANDLE ITEM 168M

CODE	WIDTH	N. TEETH	WEIGHT	PACKING
949	mm 650	27	gr. 620	Box of 12 pcs.



ITEM 168M

FIBERGLASS HANDLE ONLY FOR BROOM LEAVES ITEM 177

CODE	LENGTH	WEIGHT	PACKING	PACKING
535	mm 1400	gr. 400	Cardboard box	Box of 12 pcs.



ITEM 173

MEMORY BROOM LEAVES

CODE	WIDTH	N. TEETH	WEIGHT	PACKING
847	mm 455	27	gr. 220	Box of 12 pcs.



ITEM 173M

FIBER GLASS HANDLE WITH THREADED RING ONLY FOR BROOM LEAVES ITEM 173

CODE	LENGHT	WEIGHT	PACKING	PACKAGE
886	1500 mm	475 g	Plastic case	Box of 12 pcs.



Tying Machine perfect for all types of plants: yards, gardens and vineyards.
To be used with tapes of different thicknesses and colors.







ITEM 86
TYING MACHINE



CODE	WEIGHT	PACKING
554	520	Box

REPLACEMENT PARTS:

BLADE	STAPLES- 10,000 STAPLE BOX	STAPLE PUSHER	CLINCHER	SPRING
				
Code 556	Code 558	Code 587	Code 588	Code 744



ITEM 121
PVC TAPE

CODE	COLOR	LENGTH	BOX
557	BLUE	26 m	10 piece box
586	GREEN	26 m	10 piece box
620	OLIVE GREEN	26 m	10 piece box
621	WHITE	40 m	10 piece box
623	RED	16 m	10 piece box

Netting Machine perfect for all types of plants: yards, gardens and vineyards.

To be used with iron wire coated in plastic and paper



ITEM 87
MANUAL NETTING MACHINE

CODE	WEIGHT	PACKING
555	216 g	Blister



The **Manual Grafter 4T** is a clamp that can perform four types of grafting: Notch Graft - English Double Split Graft - Omega Graft - Bud Graft. With a single grafting can achieve all four models of cutting as it has interchangeable blades, simply by unscrewing the two screws located on the head can be mounted to the desired blade. The types of coupling are four in order to meet various needs of plants that respond differently when they are cut, so you can operate on fruit trees, vines, kiwis, flowers etc. ...



ITEM 76
MANUAL GRAFTING 4T

CODE	LENGTH	WEIGHT	PACKING
776	200 mm	295 g	Blister

REPLACEMENT PARTS:

SLOT BLADE Code 777	OMEGA BLADE Code 778	BUD BLADE Code 779
ENGLISH DOUBLE SPLIT BLADE Code 895	BIG ANVIL Code 780	SMALL ANVIL Code 781



SLOT GRAFT



ENGLISH DOUBLE SPLIT GRAFT



OMEGA GRAFT



BUD GRAFT



ITEM 96

PRUNING HOOK FOR GARDENING AND FLOWER CUTTING

Bubinga wood **HANDLE** with ring, iron bolsters and iron joint
C60-C70 tempered carbon steel **BLADE**, polished finish

CODE	LENGTH	WEIGHT	BLADE	PACKING
569	190 mm	82 g	77 mm	Blister

ITEM 97

PROFESSIONAL GRAFTING KNIFE

Bubinga wood **HANDLE**, brass bolsters, brass rivets
C70 tempered carbon steel **BLADE**, satin finish

CODE	LENGTH	WEIGHT	BLADE	PACKING
570	170 mm	65 g	64 mm	Blister

ITEM 98

TRADITIONAL GRAFTING KNIFE

Bubinga wood **HANDLE**, iron bolsters, brass rivets
C60-C70 tempered carbon steel **BLADE**, polished finish

CODE	LENGTH	WEIGHT	BLADE	PACKING
564	170 mm	56 g	64 mm	Blister

ITEM 99

TRADITIONAL CURVED BLADE GRAFTING KNIFE

Bubinga wood **HANDLE**, iron bolsters, brass rivets
C60-C70 tempered carbon steel **BLADE**, polished finish

CODE	LENGTH	WEIGHT	BLADE	PACKING
571	170 mm	56 g	64 mm	Blister

ITEM 100

GRAFTING KNIFE

ABS red plastic **HANDLE**, iron bolsters, brass rivets
C60-C70 tempered carbon steel **BLADE**, polished finish

CODE	LENGTH	WEIGHT	BLADE	PACKING
572	170 mm	46 g	69 mm	Blister

ITEM 101

CURVED BLADE GRAFTING KNIFE

ABS red plastic **HANDLE**, iron bolsters, brass rivets
C60-C70 tempered carbon steel **BLADE**, polished finish

CODE	LENGTH	WEIGHT	BLADE	PACKING
573	170 mm	46 g	69 mm	Blister

ITEM 102

STRAIGHT BLADE GRAFTING KNIFE

ABS red plastic **HANDLE**, iron bolsters, brass rivets
C60-C70 tempered carbon steel **BLADE**, polished finish

CODE	LENGTH	WEIGHT	BLADE	PACKING
574	170 mm	44 g	69 mm	Blister

ITEM 103

PRUNING HOOK FOR GARDENING AND FLOWING CUTTING

ABS red plastic **HANDLE**, iron bolsters, brass rivets
C60-C70 tempered carbon steel **BLADE**, polished finish

CODE	LENGTH	WEIGHT	BLADE	PACKING
575	170 mm	48 g	67 mm	Blister



Series of stones to sharpen blades
 To use with water for greater effectiveness of sharpening.
 For the cleaning of natural stone you may want to soak them in water and vinegar.



ITEM 53
NATURAL SHARPENING STONE

CODE	LENGTH	WEIGHT
377	10 cm	80 g



ITEM 54
CORUNDUM SHARPENING STONE

CODE	LENGTH	WEIGHT
378	10 cm	45 g



ITEM 79
TWO GRAIN RECTANGULAR STONE carbon/silicon

CODE	LENGTH	WEIGHT
515	10 cm	68 g

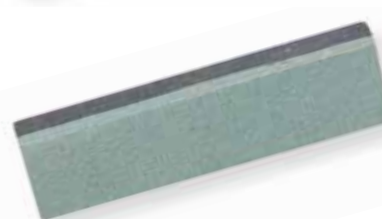

ITEM 122
NATURAL HONE STONE BERGAMO/BERGAMASCA

CODE	LENGTH	WEIGHT
649	23-24 cm	400 g



ITEM 123
NATURAL HONE STONE 3 RINGS BERGAMO

CODE	LENGTH	PESO
650	23-24 cm	340 g



ITEM 124
HONE EMERY STONE MILAN (CORUNDUM)

CODE	LENGTH	WEIGHT
651	23-24 cm	210 g



HISTORY



PAST



ARCHman

MANIAGO - ITALY

TRADITION



Old Bear
Since 1925 - Maniago - Italy
★★★★★



OLD BEAR is ARCHMAN new and exclusive folding knife line featuring simple and ergonomic lines and intentionally involves a production process engaging high levels of manual production, skilled and experienced manufacture. The

handle knife is in oil-treated walnut wood, while its blade is in stainless steel and is stone sharpened by skilled and qualified craftsman's hands.

The "Old Bear™" knife comes without no-return spring meaning its blade locking system features a solid safety ring (covered by patent n.1187282 deposited in year 1985 by Todesco company from Maniago which is active partner of this project) that fixes the handle in open and closed position.

ITEM **83N**

OLD BEAR WALNUT KNIFE STAINLESS STEEL



HANDLE knife is in oil-treated walnut wood
Tempered HRC 54÷56 stainless steel Aisi 420 **BLADE**; satin finish
Hand brushed brass **RING** with lock

CODE	LENGHT	WEIGHT	BLADE	PACKING
963	mm 150 "XS"	gr. 27	mm 60	Carton box
882	mm 170 "S"	gr. 32	mm 70	Carton box
800	mm 190 "M"	gr. 37	mm 80	Carton box
801	mm 210 "L"	gr. 62	mm 90	Carton box
883	mm 230 "XL"	gr. 67	mm 100	Carton box



ITEM **83NC**

OLD BEAR WALNUT KNIFE CARBON STEEL



HANDLE knife is in oil-treated walnut wood
C67 carbon steel **BLADE** for longer wire life; satin finish
Hand brushed brass **RING** with lock

CODE	LENGHT	WEIGHT	BLADE	PACKING
989	mm 150 "XS"	gr. 27	mm 60	Carton box
990	mm 170 "S"	gr. 32	mm 70	Carton box
991	mm 190 "M"	gr. 37	mm 80	Carton box
992	mm 210 "L"	gr. 62	mm 90	Carton box
993	mm 230 "XL"	gr. 67	mm 100	Carton box



ITEM **52N**

OLD BEAR WALNUT GRAFTING KNIFE



HANDLE knife is in oil-treated walnut wood
Tempered HRC 54÷56 stainless steel Aisi 420 **BLADE**; satin finish
Hand brushed brass **RING** with lock

CODE	LENGHT	WEIGHT	BLADE	PACKING
966	mm 175 "M"	gr. 43	mm 75	Carton box



ITEM **71N**

OLD BEAR WALNUT ELECTRICIAN KNIFE



HANDLE knife is in oil-treated walnut wood
Tempered HRC 54÷56 stainless steel Aisi 420 **BLADE**; satin finish
Hand brushed brass **RING** with lock

CODE	LENGHT	WEIGHT	BLADE	PACKING
967	mm 190 "M"	gr. 46	mm 80	Carton box



ITEM **84**

OLD BEAR WALNUT PRUNING HOOK



HANDLE knife is in oil-treated walnut wood
Tempered HRC 54÷56 stainless steel Aisi 420 **BLADE**; satin finish
Hand brushed brass **RING** with lock

CODE	LENGHT	WEIGHT	BLADE	PACKING
1021	mm 170 "S"	gr. 60	mm 75	Carton box
884	mm 215 "L"	gr. 105	mm 95	Carton box

ITEM **83U**

OLD BEAR OLIVE KNIFE STAINLESS STEEL



HANDLE knife is in oil-treated olive wood
Tempered HRC 54÷56 stainless steel Aisi 420 **BLADE**; satin finish
Hand brushed brass **RING** with lock

CODE	LENGHT	WEIGHT	BLADE	PACKING
964	mm 150 "XS"	gr. 33	mm 60	Carton box
888	mm 170 "S"	gr. 38	mm 70	Carton box
889	mm 190 "M"	gr. 43	mm 80	Carton box
890	mm 210 "L"	gr. 70	mm 90	Carton box
891	mm 230 "XL"	gr. 88	mm 100	Carton box

ITEM **83UC**

OLD BEAR OLIVE KNIFE CARBON STEEL



HANDLE knife is in oil-treated olive wood
C67 carbon steel **BLADE** for longer wire life; satin finish
Hand brushed brass **RING** with lock

CODE	LENGHT	WEIGHT	BLADE	PACKING
995	mm 150 "XS"	gr. 33	mm 60	Carton box
996	mm 170 "S"	gr. 38	mm 70	Carton box
997	mm 190 "M"	gr. 43	mm 80	Carton box
998	mm 210 "L"	gr. 70	mm 90	Carton box
999	mm 230 "XL"	gr. 88	mm 100	Carton box

ITEM **83M**

OLD BEAR MULTILAYER KNIFE



HANDLE knife is in oil-treated multilayer wood
Tempered HRC 54÷56 stainless steel Aisi 420 **BLADE**; satin finish
Hand brushed brass **RING** with lock

CODE	LENGHT	WEIGHT	BLADE	PACKING
965	mm 150 "XS"	gr. 27	mm 60	Carton box
898	mm 170 "S"	gr. 33	mm 70	Carton box
899	mm 190 "M"	gr. 39	mm 80	Carton box
900	mm 210 "L"	gr. 57	mm 90	Carton box
901	mm 230 "XL"	gr. 60	mm 100	Carton box



ITEM **83B**

OLD BEAR BLACK KNIFE



Black laminated wood **HANDLE**
Tempered HRC 54÷56 stainless steel Aisi 420 **BLADE**; black PTFE coated
Brass **RING** with chemical nickel-plating

CODE	LENGHT	WEIGHT	BLADE	PACKING
970	mm 150 "XS"	gr. 27	mm 60	Carton box
971	mm 170 "S"	gr. 33	mm 70	Carton box
972	mm 190 "M"	gr. 39	mm 80	Carton box
973	mm 210 "L"	gr. 57	mm 90	Carton box
974	mm 230 "XL"	gr. 60	mm 100	Carton box



ITEM **83TB**

OLD BEAR TOTAL BLACK KNIFE



Black laminated wood **HANDLE**
Tempered HRC 54÷56 stainless steel Aisi 420 **BLADE**; black PTFE coated
Aluminum **RING** with black anodization

CODE	LENGHT	WEIGHT	BLADE	PACKING
976	mm 150 "XS"	gr. 19	mm 60	Carton box
977	mm 170 "S"	gr. 25	mm 70	Carton box
978	mm 190 "M"	gr. 31	mm 80	Carton box
979	mm 210 "L"	gr. 43	mm 90	Carton box
980	mm 230 "XL"	gr. 46	mm 100	Carton box



ITEM **83R**

OLD BEAR RAINBOW KNIFE

CODE	LENGHT	WEIGHT	BLADE	PACKING
983	mm 150 "S"	gr. 27	mm 60	Carton box
984	mm 170 "S"	gr. 33	mm 70	Carton box
985	mm 190 "M"	gr. 39	mm 80	Carton box
986	mm 210 "L"	gr. 57	mm 90	Carton box
987	mm 230 "XL"	gr. 60	mm 100	Carton box



ITEM **179**

OLD BEAR LEATHER KNIFE HOLDER

CODE	SUITABLE FOR
968	XS - S - M
969	L - XL





ITEM 74N

OLD BEAR WALNUT STAINLESS STEEL DISPLAYS

KNIVES handle in oil-treated walnut wood stainless steel Aisi 420 **BLADE**

CODE	DESCRIPTION	PACKING
887	3S+3M+4L+3XL	Carton box

ITEM 74NC

OLD BEAR WALNUT CARBON STEEL DISPLAYS

KNIVES handle in oil-treated walnut wood C67 carbon steel **BLADE**

CODE	DESCRIPTION	PACKING
994	3S+3M+4L+3XL	Carton box

ITEM 74U

OLD BEAR OLIVE STAINLESS STEEL DISPLAY

KNIVES handle in oil-treated olive wood stainless steel Aisi 420 **BLADE**

CODE	DESCRIPTION	PACKING
897	3S+3M+4L+3XL	Carton box

ITEM 74UC

OLD BEAR OLIVE CARBON STEEL DISPLAY

KNIVES handle in oil-treated olive wood C67 carbon steel **BLADE**

CODE	DESCRIPTION	PACKING
1000	3S+3M+4L+3XL	Carton box

ITEM 74M

OLD BEAR MULTILAYER DISPLAY

KNIVES handle in multilayer wood

CODE	DESCRIPTION	PACKING
907	3S+3M+4L+3XL	Carton box

ITEM 74B

OLD BEAR BLACK DISPLAYS

KNIVES handle in black laminated wood

CODE	DESCRIPTION	PACKING
975	3S+3M+4L+3XL	Carton box

ITEM 74R

OLD BEAR RAINBOW DISPLAY

KNIVES handle in multicolor laminated wood

CODE	DESCRIPTION	PACKING
988	3S+3M+4L+3XL	Carton box

ITEM 74TB

OLD BEAR TOTAL BLACK DISPLAY

KNIVES handle in black laminated wood

CODE	DESCRIPTION	PACKING
981	3S+3M+4L+3XL	Carton box

ITAM **73N-U**

OLD BEAR WALNUT AND OLIVE STAINLESS STEEL DISPLAYS

KNIVES handle in walnut and olive stainless steel blade

CODE	DESCRIPTION	PACKING
893	2x (XS-S-M-L-XL) walnut 2x (XS-S-M-L-XL) olive Total 20 knives	Carton box



ITEM **74B-TB**

OLD BEAR BLACK AND TOTAL BLACK DISPLAYS

KNIVES handle in black laminated wood

CODE	DESCRIPTION	PACKING
982	1x (XS-S-M-L-XL) Black 1x (XS-S-M-L-XL) Total Black Total 10 knives	Carton box



ITEM **74FC**

OLD BEAR FULL COLOR DISPLAYS

KNIVES handle in colored wood

CODE	DESCRIPTION	PACKING
894	6 x S (different colors) 16 x M (different colors) Total 12 knives	Carton box



ARCHMAN

MANIAGO - ITALY

The ARCHMAN line offers suitable quality sheaths and accessories that allow professionals to work with ease.



ITEM 50

LEATHER SHEARS HOLDER WITH BELT

CODE

370



ITEM 77

RUBBERY PLASTIC SHEATH WITH TWO POCKETS FOR SHEARS AND SAW

CODE

519



ITEM 51

LEATHER SHEARS HOLDER WITH BELT

CODE

371



ITEM 70

LEATHER SHEARS HOLDER WITH BELT

CODE

425





ITEM 14
WOOD SALES POINT DISPLAY

The ARCHMAN sales point display is made with wood and is formed by interlocking modular panels that are assembled without using any screws and tool that allows you to easily assemble in a short time. Equipped with hooks and banner with product photo and ARCHMAN logo. Total size: cm.60x39x170h

CODE
841

ITEM 11

SNIPER AND HELIUM DISPLAY 5 PLACES

SNIPER NAD HELIUM display for sales point in an exclusive ARCHMAN design made entirely of painted steel and equipped with special hooks
Dimension cm.55x37x122H it is not cumbersome and therefore easy to place inside the point of sale.
Weight kg.11

CODE **DISPLAY FOR**
763 **5 PCS. TOP PRUNER**



ITEM 81
MODULAR COUNTER DISPLAY

The ARCHMAN counter display can be supplied already assembled, complete with shears, or unassembled since it is easy to put together. Made entirely from polypropylene, it is tough and resistant. Very little space is needed to display 12 shears, either of the same model or a variety.



CODE **CARDBOARD DISPLAY**
189 **FOR SHEARS**
12 PIECES



CODE **CARDBOARD**
216 **DISPLAY FOR SAWS**
12 PIECES



CODE	SIZE
ARC-G1	S
ARC-G2	M
ARC-G3	L
ARC-G4	XL

SOFT SHELL JACKET

with three layers waterproof and breathable

- 97% polyester - 3% elastane
- 6000 mm / H2O water resistance
- breathability 4000 g / M2 / 24h
- detachable sleeves
- interior in anti-pilling fleece
- detachable hood with zip
- taped hinges
- chest pocket with zip
- two external pockets with zip
- zip pocket on the arm
- internal mobile phone pocket
- elastic cuffs with adjustable Velcro
- drawstring at the bottom



CODE	SIZE
ARC-F1	S
ARC-F2	M
ARC-F3	L
ARC-F4	XL

SWEAT

in 100% polyester knit, knitted fabric with internal raising

- contrasted zippers
- zip on the arm
- two zip pockets
- reinforcement tape inside the collar
- stretch fabric at the cuffs and at the bottom of the shirt



CODE	SIZE
ARC-TS1	S
ARC-TS2	M
ARC-TS3	L
ARC-TS4	XL

T-SHIRT

- 100% cotton 30/1 ring spun soft
- thin ribbed crew neck
- European cut, tubular structure



CODE	SIZE
ARC-CAP	one size

CAP



MANIAGO - ITALY

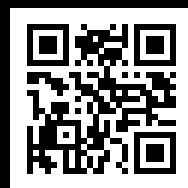

www.archman.it

ARCHMAN S.r.l. Via Cristans, 10 - 33085 MANIAGO (PN) - ITALY
Tel +39.0427.71150 / 701020 - Fax +39.0427.71150 - info@archman.it