

Healthy Choice[®]

COLD BREW COFFEE MAKER



Model: CB707 | Batch: PR4685

Carefully read all instructions before use and save for future reference.

Contents

Important Safeguards	4-5
Parts	6-7
Assembly & Disassembly How to Use Your Cold Brew Coffee Maker	8-10
Brewing Tips	11
Recipes	12
Care & Cleaning	13-14

IMPORTANT SAFEGUARDS

PLEASE READ AND SAVE THIS INSTRUCTION MANUAL FOR FUTURE REFERENCE

When using the appliance, basic safety precautions should be followed, including:

1. READ ALL INSTRUCTIONS.
2. Remove all packaging from the appliance before first use.
3. Wash and dry the appliance thoroughly before use.
4. Unplug the appliance before disassembling, cleaning, and when not in use.
5. All parts must be properly assembled before use.
6. To protect against the risk of electric shock, never immerse the cord, plug, or main unit in water or any other liquid.
7. Operate the appliance on a stable and dry surface only.
8. Do not operate the appliance if the cord or plug are damaged. If the appliance malfunctions or is damaged, return the appliance to the supplier for examination, repair, or electrical and/or mechanical adjustment.
9. Refrain from using attachments that are not recommended by the appliance manufacturer, as this may result in fire, electric shock, or personal injury.
10. Do not use outdoors. This appliance is intended for indoor and household purposes only.
11. This appliance is not intended for use by persons (including children) with reduced physical, sensory, or mental capabilities, or lack of experience and knowledge unless they are provided with supervision and instruction concerning the use of the appliance by a person responsible for their safety.

12. Never immerse the main unit in water or any other liquid; instead, wipe the surface with a soft, damp cloth and then dry thoroughly.
13. Children should not play with the appliance.
14. Always be sure to unplug the appliance from the power outlet before assembly, disassembly, cleaning, and storage.
17. This appliance is intended for household use ONLY; It is not for commercial or industrial use.
18. Always turn off and unplug the appliance if left unattended.
19. Check and make sure the voltages and currents of the appliance are compatible with the power supply.
20. USE ONLY COLD OR ROOM-TEMPERATURE WATER. NEVER USE HOT WATER.

PARTS

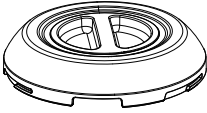

Lid



Top Filter

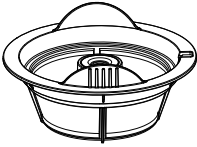

Coffee Basket

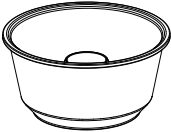

Ice Basket



Removable Sprayer

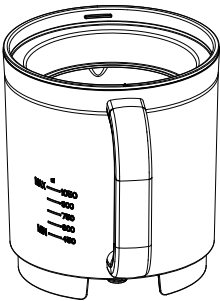

Jug

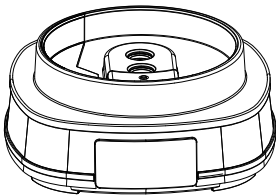

Main Unit

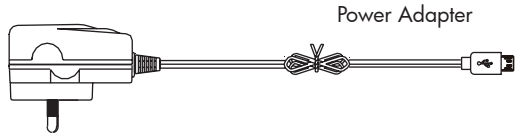

Power Adapter

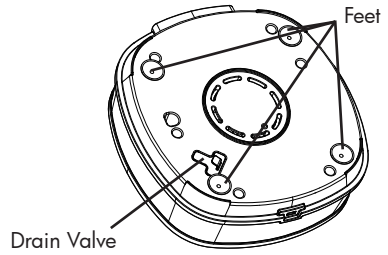

Drain Valve

Feet

Inner Inlet Filter

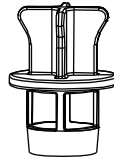

CONTROL PANEL DETAILS:

START / STOP

Touch the START / STOP icon to start or stop. Long press for 3 seconds to reset.

TIME

Touch the TIME icon to set the working time. Options include 10, 20, 30 and 40 minutes.

Long press for 3 seconds for the chilling cycle. CH:LL will be displayed on the control panel.

Add ice cubes into the ice basket after the cold brewing cycle is finished. The machine will run the chilling program for 6 minutes.

ASSEMBLY & DISASSEMBLY

HOW TO USE YOUR COLD BREW COFFEE MAKER

1. Remove all packaging and clean all the parts before first use.

2. Fill the jug with room-temperature water and place it on the main unit (Fig.1)

NOTE: PLEASE DO NOT ADD HOT OR ICED WATER. DO NOT FILL WATER BEYOND THE MAX LINE - MAX CAPACITY IS 1050ML.

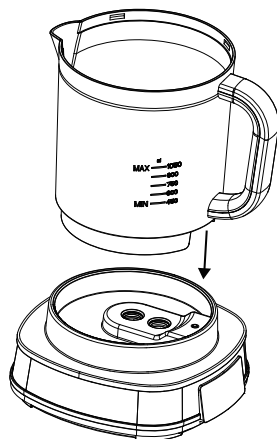

Fig.1

3. Install the removable sprayer into the sprayer connector and turn clockwise to lock it into place. (Fig.2)

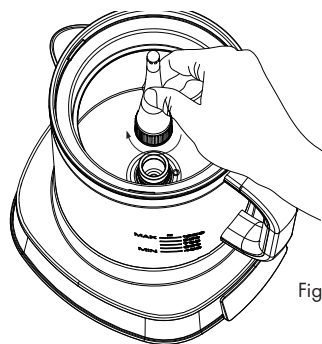

Fig.2

4. Add medium or coarse ground coffee into the coffee basket. The max coffee weight is 60g (there are lines on the inner side of the filter basket's four ribs to indicate the max line). Then place the coffee basket in the top section of the jug and lightly press down. (Fig.3)

NOTE: FINE COFFEE GROUNDS ARE NOT SUITABLE TO USE IN THE COLD BREW COFFEE MAKER.

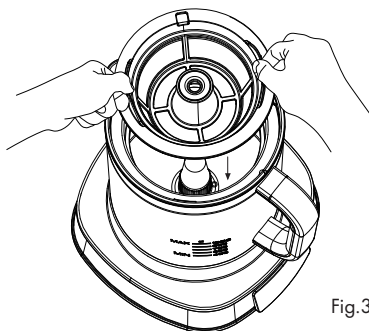

Fig.3

5. Put the top filter on top of the coffee basket and lightly press down to lock it in place. (Fig.4)

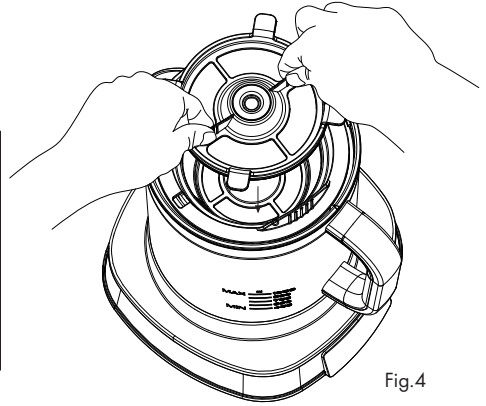

Fig.4

CAUTION: TO AVOID COFFEE POWDER BLOCKING THE PUMP OR PIPES, ALWAYS USE THE TOP FILTER. BE CAREFUL NOT TO SPILL COFFEE GROUNDS INTO THE JUG.

6. Place the lid on the jug, align the lock symbols with the arrows and turn to lock into place. (Fig.5)

7. Connect the power adapter. Select the time (10, 20, 30 or 40 minutes) and touch the START / STOP to begin the brewing cycle.

To cancel brewing, touch START / STOP again.

TIP: When the brewing cycle has commenced you can add more time in 1-minute increments by touching the time icon.

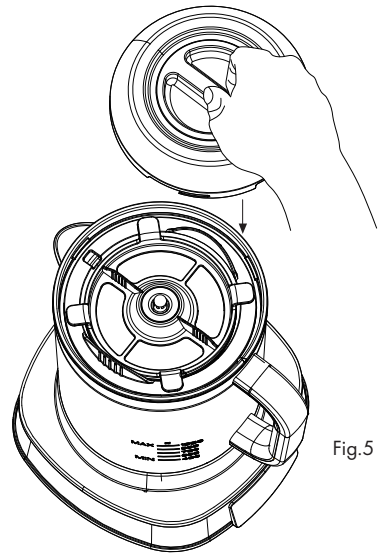

Fig.5

8. When the brewing cycle has been completed, the screen will stop the countdown, signalling that the coffee is ready.

9. After brewing, remove the coffee basket and the top filter.

10. To cool the coffee further, add some ice to the ice basket and place it in the jug. Place the top filter and the lid. Long press the TIME icon for 3 seconds to start the chilling cycle. CH:LL will be displayed on the control panel. The machine will run the chilling program for 6 minutes. (Fig.6)

NOTE: DO NOT ADD MORE THAN 160G OF ICE.

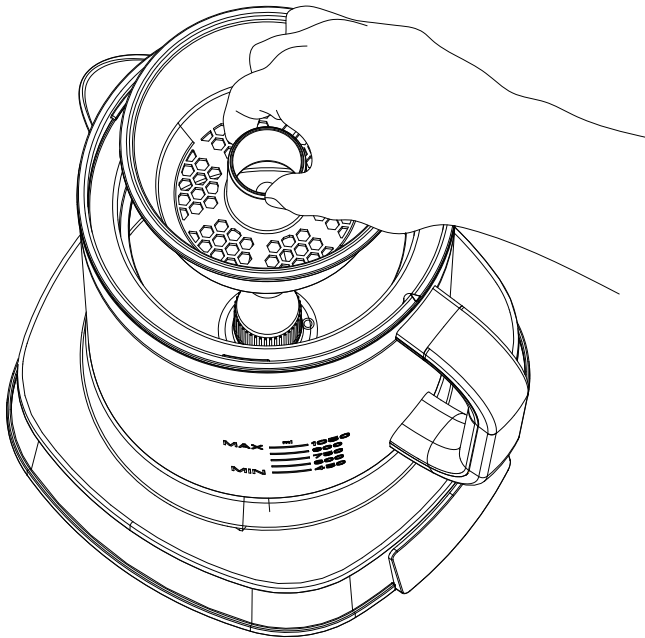

Fig.6

BREWING TIPS

Water volume	Coffee grounds
450ml / 3 cups	40g
600ml / 4 cups	50g
750ml / 5 cups	60g
900ml / 6 cups	60g
1050ml / 7 cups (Max line)	60g

Brew strength	Work time
Light	10 minutes
Medium	20 minutes
Strong	30 minutes
Concentrate	40 minutes

TONIC COLD BREW RECIPE

INGREDIENTS:

100ml cold brew concentrate
150ml chilled tonic water
ice cubes
slice of a fresh orange

INSTRUCTIONS:

1. Pour the cold brew concentrate into a tall glass. Top with the chilled tonic water, add ice cubes and garnish with an orange slice.
2. Serve immediately.

SPARKLING MINT COLD BREW RECIPE

INGREDIENTS:

75ml cold brew concentrate
125ml chilled soda water
fresh mint leaves
ice cubes
slice of a fresh lemon

INSTRUCTIONS:

1. Pour the cold brew concentrate into a tall glass. Top with the chilled soda water. Add mint leaves, ice cubes and stir. Garnish with an lemon slice.
2. Serve immediately.

CARE & CLEANING

Make sure the appliance is disconnected from the power supply before cleaning.

Never immerse the main unit in water or any other liquid. Wipe with a damp cloth and dry thoroughly.

CLEANING:

1. Remove the lid, top filter, coffee basket, and ice basket from the jug. Discard coffee grounds and wash all elements thoroughly.
2. Pour fresh cold water into the jug, place the lid on top and run a 10-minute brewing cycle to clean the pump.
3. Remove the jug from the main unit and pour out the pump-cleaning water.
4. Turn the removable sprayer counterclockwise to remove it from the jug. Wash it thoroughly.
5. Lift the drain valve, located on the bottom of the main unit, to drip out the old coffee/water from the pump and pipes.

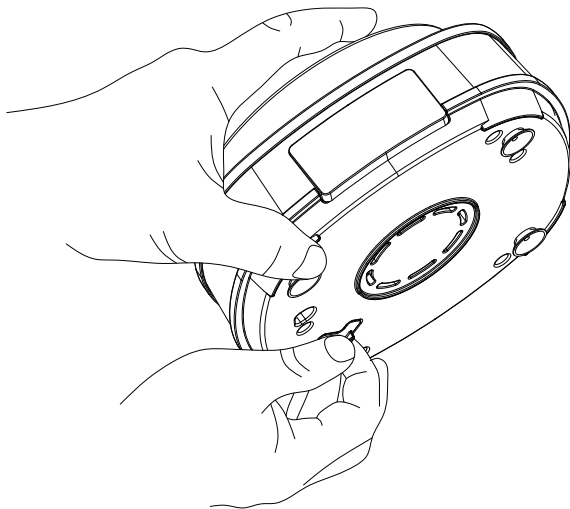

CAUTION:

Please clean the machine after every use and pay attention especially to step 5, as this may significantly influence the flavour and quality of your future brews.

The drain valve **MUST** be properly closed after cleaning, otherwise, machine can not be used and water will leak from the bottom of the main unit.

6. Dry all parts after cleaning.

CAUTION: Do not pour any water into the main unit once the jug has been removed.

All parts listed below can be washed in warm, soapy water and rinsed thoroughly, or cleaned in the top drawer of a dishwasher.

- Lid
- Top filter
- Coffee basket
- Ice basket
- Removable sprayer
- Jug

LENOXX®

www.lenoxx.com.au



1300 666 848



LenoxxElectronics



LenoxxElectronics



@LenoxxAustralia