

LENOXX
AP90

AIR PURIFIER

with CADR 170m³/h



Model: AP90

Batch: PR4081

PLEASE READ AND RETAIN THESE INSTRUCTIONS FOR FUTURE REFERENCE.

THIS PRODUCT IS INTENDED FOR HOUSEHOLD USE ONLY.

The illustrations used in the manual are to illustrate the operation method and structure of the product. Where there is a small difference between the physical item and the illustrations, please take the physical as the standard.

ABOUT THE PRODUCT:

Air treatment is heavily influenced by the extreme weather conditions of bushfires and floods. This puts a strain on asthma and allergies, causing breathing difficulties. This Air Purifier with CADR 170m³/h will prevent interior risks of poor air quality with its sleek design, smart features and high-filtration performance.

Featuring a HEPA filter with activated carbon, this air purifier has a CADR, known as Clean Air Delivery Rate, of 170m³/h and an area coverage of 20m² for high level air purification. There's nothing more important than the air we breathe and this air purifier is here to ensure it's always a cleaner, healthier experience in the place you spend most of your time; your home or small office.

With four fan speeds, you can choose from low, medium, high or sleep mode. The intelligent sleep mode senses the light in the room and self-adjusts the fan speed while dimming the indicator lights, perfect for a good night's rest. Enjoy a low noise level, 7 colour-changing lights and an adjustable bright white light, an adjustable standby mode night light in warm-white and cool-white temperatures, air quality sensor to display the indoor air quality, keylock mode to lock all buttons while your little ones are around and a filter replacement indicator. You can also choose a set time of two, four or eight hours of purification time before the air purifier powers off. Alternatively, the brilliant memory will remember the fan speed.

We recommend replacing the filters about every six to eight months, sooner or later depending on the frequency of use and pollution level in the environment. The filter replacement indicator will illuminate on the touch screen and an increased operating noise coupled with decreased airflow will signal it is time to change out the size 18.6cm x 14.2cm HEPA filter. Changing the filter is as simple as twisting open the bottom of the air purifier and swapping out the filter. This air purifier comes pre-packaged with one HEPA filter. Always ensure the packaging is removed first before inserting the filter into the air purifier.

It's time to finally breathe easy with our impressive Air Purifier with CADR 170m³/h.

IMPORTANT SAFEGUARDS:

When using electrical appliances, basic safety precautions should always be followed, including the following:

1. Read instructions carefully before use.
2. Remove and safely disregard any packaging material and labels before using this product for the first time. Ensure children and babies do not play with plastic bags or any packaging materials.
3. If the filter is covered by a plastic bag when shipped, remove the plastic bag before use.
4. Before use, check that your local voltage corresponds with the specifications shown on the appliance nameplate located under the appliance.
5. Always operate the appliance on a horizontal surface which is level, stable and non-combustible. Never place on soft surfaces such as a bed or sofa as this could cause the unit to tip over and block the air inlet or outlet vents.
6. Do not place the appliance on or near a hot gas or electric burner, or in a heated oven.
7. Never connect this appliance to an external timer or separate remote-control system.
8. Never use this appliance with an extension cord or power board. Ensure it is plugged into a dedicated power point and without any other appliances on the same outlet.
9. Do not turn on the power until the appliance and parts are in place as required.
10. To protect against electric shock, do not immerse the cord, plug, or appliance in water or any other liquid. Do not expose the appliance to dripping or splashing and ensure that no objects filled with liquids such as vases are placed on the appliance. Do not rinse it under the tap. The air purifier is not an aromatiser or vaporiser. Do not put any water or other liquid into the main housing of the appliance through the vents.
11. Do not touch the appliance, power cord or power plug with wet hands.
12. Unplug from the outlet when not in use and before cleaning or moving the unit, opening the base, changing the filter.
13. The appliance does not contain any serviceable parts inside. Do not attempt to open and repair the unit yourself. All components should only be serviced by a qualified technician.
14. Do not use the appliance if the plug, power cable or unit itself are damaged. If the power cord is damaged, you must have it replaced at a service centre with qualified persons in order to avoid a hazard.
15. Do not use the appliance for anything other than the intended use. It is for household use only. It is not to be used outdoors or for commercial purposes.

16. Close supervision is necessary when any appliance is used near children. Keep the appliance and power cord out of reach of children when it is in operation.

17. This appliance is intended to be used in household and similar applications such as:

- Staff kitchen areas in shops, offices and other working environments;
- Farm houses;
- By clients in hotels, motels and other residential type environments;
- Bed and breakfast type environments

18. This air purifier should be operated on a separate electrical power point from other operating appliances. If the power point is overloaded with other appliances, this air purifier may not work properly.

19. Leave enough open space from other objects while in use. Do not block air intakes or exhausts.

20. Do not place the appliance against a wall or against other appliances. Leave at least 5 inches of free space on the back and sides and above the appliance. Do not place anything on top of the appliance.

21. Do not cover the air purifier while in use.

22. Do not let the cord hang over the edge of the table or counter.

23. Do not unplug the air purifier by pulling on the cord.

24. This appliance is not designed to be used by people (including children) with a physical, sensory or mental impairment, or people without knowledge or experience, unless they are supervised or given prior instructions concerning the use of the appliance by someone responsible for their safety. Children must be supervised to ensure that they do not play with the appliance.

25. Do not leave the appliance operating while unattended.

26. Never drop or insert any objects into the openings of the unit.

27. The appliance should only be used in a room with a temperature between 4 Degrees Celsius and 43 Degrees Celsius.

SHORT CORD INSTRUCTIONS:

Do not use with an extension cord. A short power supply cord is provided to reduce the risks resulting from being entangled in or tripping over a long cord.

PREPARATION FOR USE:

Before using the air purifier for the first time:

Carefully unpack the air purifier and remove all the packing materials.

Place the air purifier on a flat and stable surface.

Use a soft cloth to remove any dust on the surface that may happen during packing and transport.

PRODUCT STRUCTURE:

- 1. Control panel
- 2. Night light
- 3. Air outlet
- 4. Upper body
- 5. Power cord
- 6. Air inlet
- 7. True HEPA-4 stage filter
- 8. Base cover

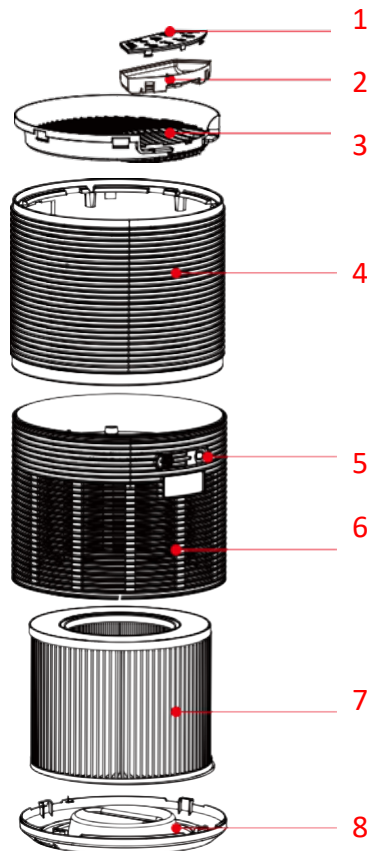

BEFORE FIRST USE:

PLACING THE FILTERS:

The air purifier comes with all filters fitted inside, but the filter packaging needs to be removed before you can use the air purifier. Remove all the filters, unpack them and place them back into the air purifier as described below, ensuring the filters are inserted in the correct position.

1. Put the air purifier upside down on a soft cloth to avoid scratching, to open the base cover, you need to find an arrow point ▲ on the base cover corresponding the LOCK position, turn the base cover counter-clockwise from LOCK to OPEN position, then the lock is released.

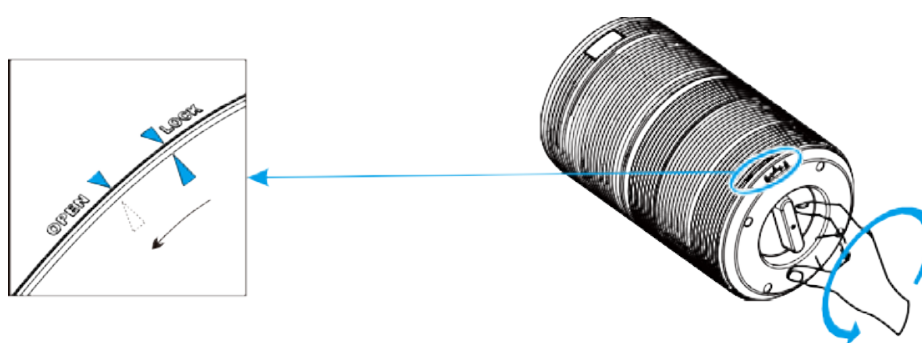

2. Remove the base cover and take out the filter.
3. Remove the packaging material from the filter.

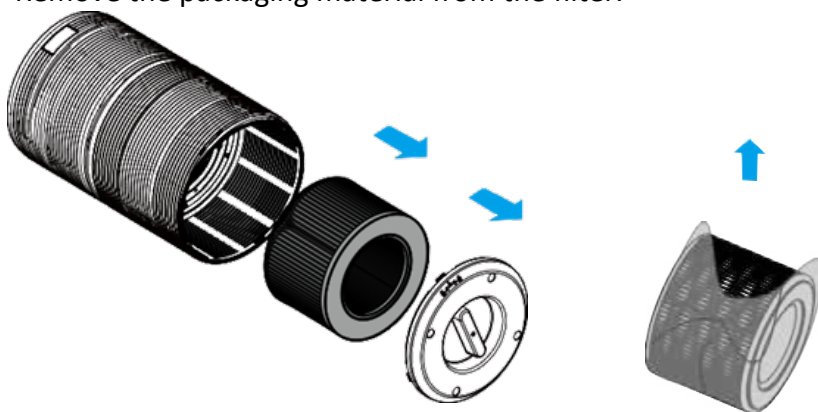

4. Put the filter back into the air purifier.



5. Turn the base cover clockwise from OPEN position to LOCK position, you will hear a "click" sound, the base cover is fastened.

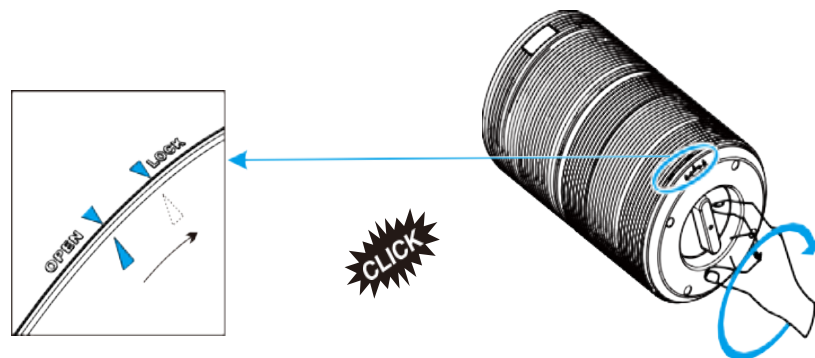

USING THE AIR PURIFIER:

CONTROL PANEL:

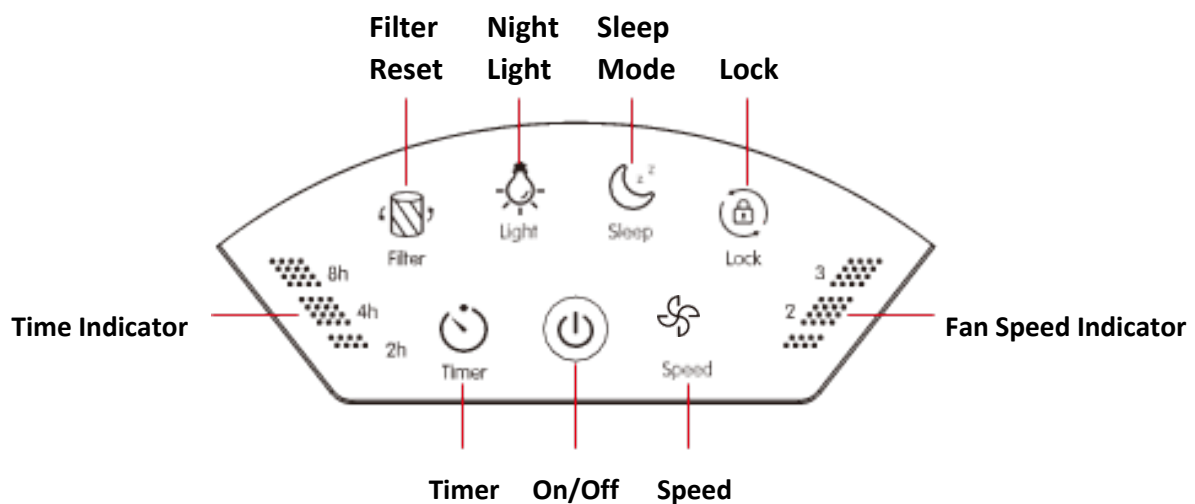

1. Plug the air purifier into a power point,

All the lights will come on, the air purifier will make a beep sound and the all the lights will go off.

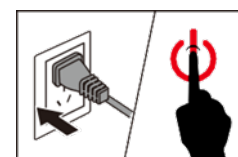

2. Press the power button to switch the air purifier on.

The power light. The night light will be on and fan speed 2 light will be illuminated.

3. Fan speed adjustment:

The fan speed light indicated at which fan speed the air purifier is operating.

Press the speed button to adjust the fan speed level, there are 3 levels to choose from; 1 – 3 refers to low, medium or high.

4. Sleep mode:

When the air purifier is set onto sleep mode, it operated very quietly.

Press the sleep button to activate the sleep mode.

The timer and sleep buttons will be illuminated at half brightness. All other buttons will not be illuminated.

Press any button to end the sleep mode except the filter button or the timer button.

5. Light:

When the purifier is powered on, the light will be illuminated white and on breathing mode. Breathing mode is a light changing pattern from low light to high light on a repeat cycle.

Working state:

Press the light button to change to bright white illumination.

Then press again to change to half brightness illumination.

Then press again to change to see a changing light cycle of 7 colours.

Then press again to turn off the light.

Press and hold the light button for 3 seconds to turn the breathing mode on or off.

While the light is in colour changing mode, press and hold the light button for 3 seconds, the colour will be on without breathing mode.

Press and hold the light button for 3 seconds to have the coloured light on with the breathing mode also on.

Standby status (night light mode):

When the air purifier is in standby mode:

Press the light button to turn on the night light. The light will be orange and on half-light.

Press the light button again to change the night light mode to orange at full brightness.

Press the light button again to change the night light mode to white half brightness.

Press the light button again to change the night light mode to white full brightness.

Press the light button again to turn the night light off.

6. Setting a timer:

The timer function allows a 2 hour, 4 hour or 8 hour operation time to be set.

Press the timer button to choose between 2 hour, 4 hour or 8 hour mode.

The air purifier will automatically power off once the timer is finished.

Press the timer button to set a timer and to cycle through the timer options.

Press time timer button or unplugging the air purifier will cancel the timer.

7. Keylock mode:

Press the lock button to activate the keylock mode.

All buttons will be locked to avoid controls being accessed.

To cancel the keylock mode, press and hold the lock button for 3 seconds.

8. Filter replacement light:

When the filter replacement light is illuminated, the filter needs to be cleaned or replaced.

Note: the filters lifetime is based on your homes air quality and usage time of the air purifier.

Using the air purifier in a humid environment will reduce the lifetime of the filter.

9. Memory function:

When the air purifier is plugged in, it will remember its previous fan speed setting.

FILTER REPLACEMENT:

It is recommended to change the air filter every 6–8 months. However, you may need to change your filter sooner or later depending on how often you use your air purifier.

It is important to watch out for the following signs of expired filter:

- Increased operating noise
- Decreased airflow
- Clogged filter
- Increased presence of odours

NOTE:

- The environment in which the air purifier being used may also extend or shorten the lifetime of the filter. Using your air purifier in an environment of relatively high pollution may mean you will need to change the filter more often.
- If the air pollution in your environment is very high, there is a possibility that the filters may not be completely effective and may need to be replaced before the change filter light is illuminated.
- Remember to reset the air purifier after changing the filter.

HOW TO REPLACE THE FILTER:

1. Switch off the air purifier and unplug it. (a)

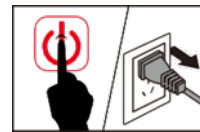

(a)

2. Put the air purifier upside down on a soft cloth to avoid scratching, to open the base cover, you need to find an arrow point on the base cover corresponding the LOCK position, turn the base cover counter-clockwise from the LOCK to OPEN position, then the lock is released. (b)

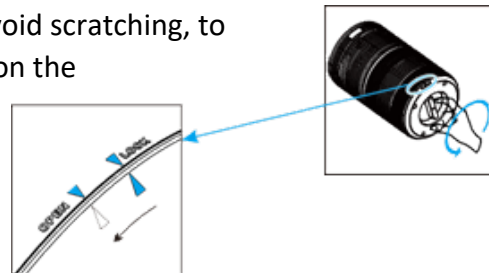

(b)

3. Remove the old filter. (c)



(c)

4. Remove the packaging material of the new filter. (d)

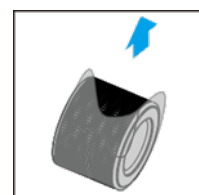

5. Put the new filter back into the air purifier. (e)

(d)

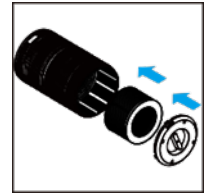

6. Turn the base cover clockwise from OPEN position to LOCK position.

(e)

You will hear a click sound; the base cover will be fastened. (f)

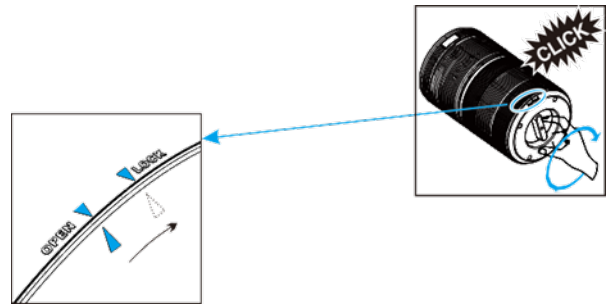

(f)

7. Plug the air purifier back into a power point and switch it on again. (g)

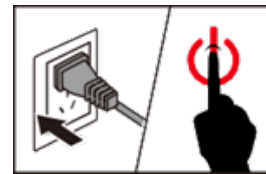

(g)

8. Re-set the filter's lifetime:

The filter's lifetime needs to be re-set if the filter light is illuminated after replacing the filter.

- Plug in the air purifier and turn it on.
- Press and hold the filter button for 3 seconds.
- Release the filter light button and the light will turn off indicating that the re-set is complete.

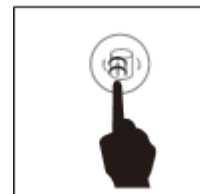

FILTER REPLACEMENT FORCE MODE:

When using the air purifier in an environment of heavy pollution, the lifespan of the air filter may be significantly reduced. You can change the filters even if the filter light does not illuminate. Follow the steps below to perform a hard reset.

1. Replace the air filter as mentioned in the Filter Replacement section.
2. Plug in the air purifier and turn it on.
3. Press and hold the filter button for 3 seconds, and it will light up.
4. Press and hold the filter button again for 3 seconds, and it will turn off. The reset is now complete.

CLEANING:

Regularly clean the inside and outside of the body to prevent dust from collecting on the inside and outside.

1. Always unplug the air purifier before you clean it.
2. Wipe away dust with a soft dry cloth from the body of the air purifier.
3. Clean the air inlet and the air outlet with a soft dry cloth.
4. Never immerse the air purifier in water or any other liquid.
5. Never use aggressive or flammable cleaning agents such as bleach or alcohol to clean any part of the air purifier.
6. The HEPA filter is NOT washable.

STORAGE:

Unplug the power cord, then wipe the air purifier clean, put the air purifier in a plastic bag and then store it away in a dry place.

Do not rinse it under the tap.

TROUBLESHOOTING:

Problem	Cause	Solution
Air purifier does not power on.	Unit is not plugged into an electrical outlet.	Connect the plug to a powered electrical outlet.
	Outlet is not working properly.	Try plugging the air purifier into a different outlet.
	Power button has not been pressed after plugging in the air purifier.	Press '⏻' once to turn on the air purifier.
	Power cord is damaged.	Immediately discontinue use and contact Customer Support .
	Air purifier is defective or malfunctioning.	
Air purifier does not respond to button controls.	Air purifier is not plugged into an outlet.	Connect the plug to a powered electrical outlet.
	Air purifier is defective or malfunctioning.	Immediately discontinue use and contact Customer Support.
Air purifier makes an unusual noise while operating.	Air filters are dirty.	Replace the air filters as instructed in the Filter Replacement section.
	Filter does not fit properly.	Properly place filter(s) as noted in the Before first use and Filter Replacement sections.
	Foreign object inside the unit.	Immediately discontinue use and contact Customer Support . DO NOT attempt to open the air purifier.
Significantly reduced airflow.	Filter packaging has not been removed.	Remove filter from packaging before use.
	Fan speed is low.	Press '🌀' to adjust fan speed.
	Air filters need to be replaced.	Replace the air filters as instructed in the Filter Replacement section.
	Not enough clearance on all sides of the purifier.	Ensure there is at least 38 cm (15 inches) of clearance on all sides of the purifier.
Poor air purification quality.	Air filters need to be replaced.	Replace the air filters as instructed in the Filter Replacement section.
	Room is too large for the air purifier's applicable area.	Ensure the room is smaller than (120 ft ²).
	Air inlet or outlet is blocked.	Remove objects blocking air inlet or outlet.
	Filters not properly placed in housing.	Properly place filters as noted in the Before first use and Filter Replacement sections.
Filter reset button is still illuminated after replacing the air filters.	The air purifier has been reset incorrectly.	See the Filter Replacement section on how to properly reset the unit.
Air purifier turns on, then suddenly turns off.	Air purifier is defective or malfunctioning.	Immediately discontinue use and contact Customer Support . DO NOT attempt to open the air purifier for self-servicing.
Air purifier beeps repeatedly after being powered on or plugged in.		

SPECIFICATIONS:

Product: AP90

Takes filter model: APF90

Power: 35W

Voltage: 220-240V / 50Hz

Application area: 20m²

LENOXX

www.lenoxx.com.au

 1300 666 848

 LenoxxElectronics

 LenoxxElectronics

 @LenoxxAustralia