

Rev	Date
A	12 / 08 / 2021

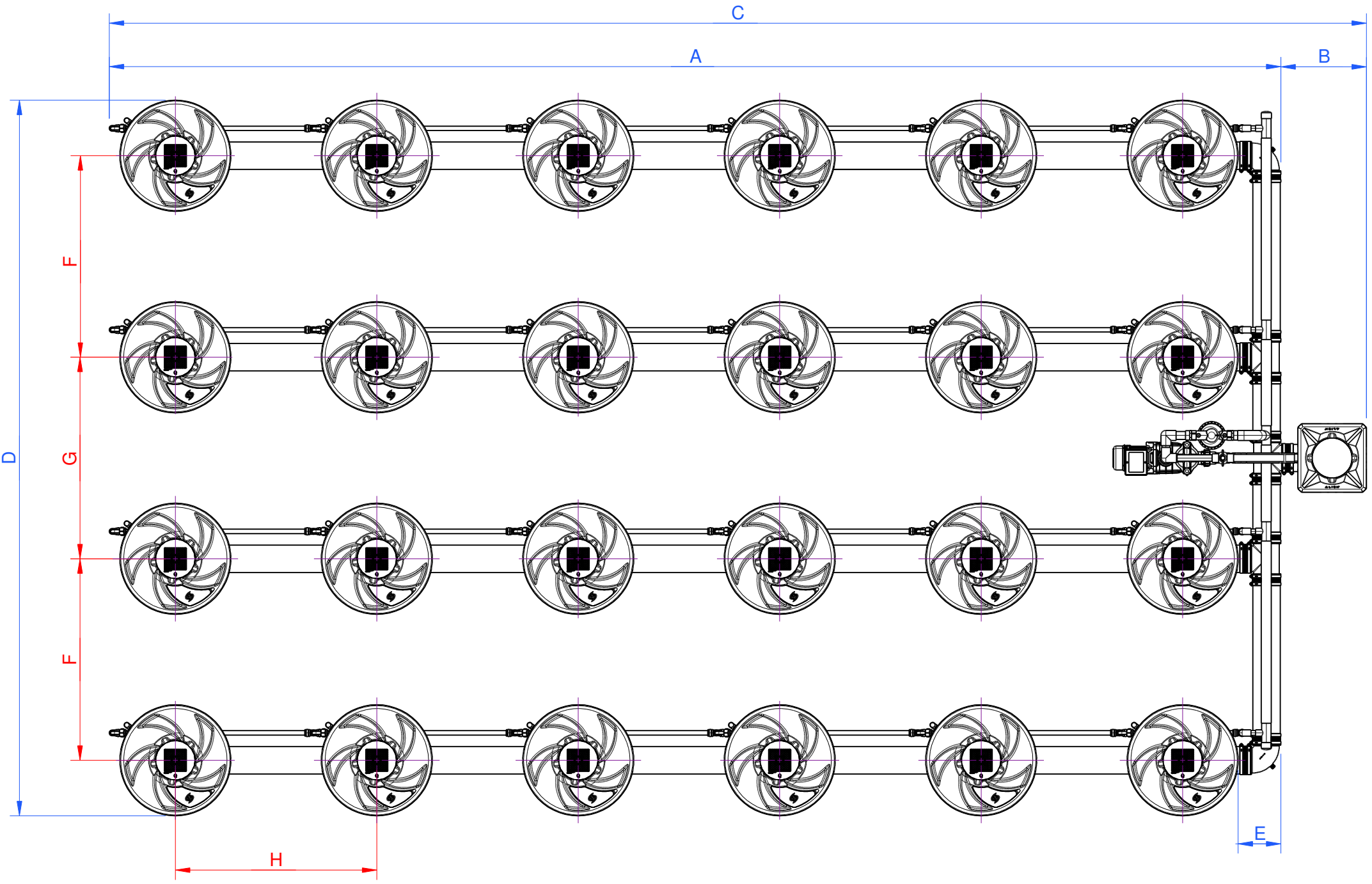

Inverted Header:

The header can be located inside the footprint as shown.

This option reduces overall length of system to dimension "A" (please refer to dimensions table).

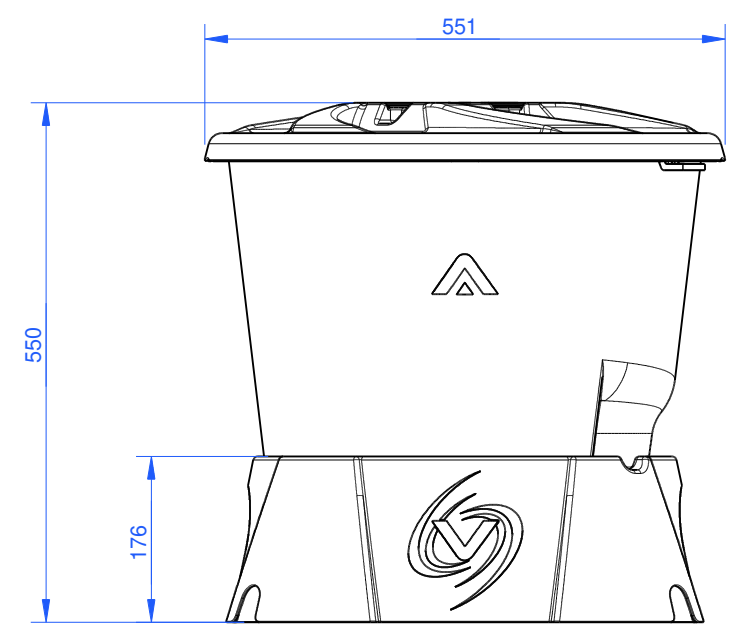
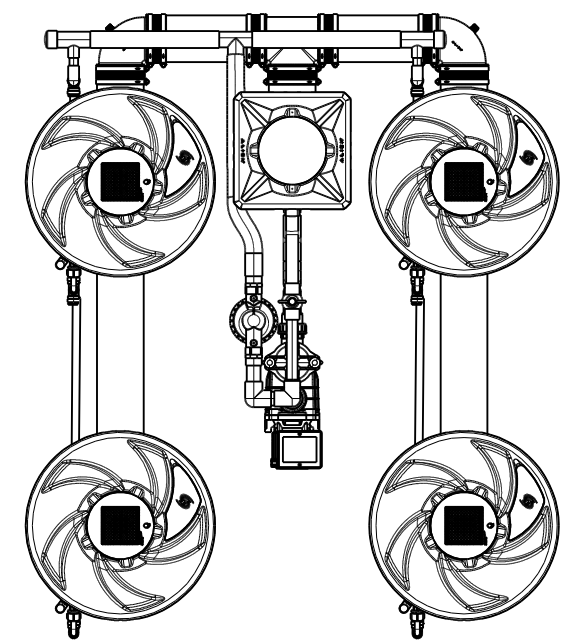

Dimensions (mm)	Minimum (mm)	Maximum (mm) @ 1m Plant Centres*
A	3690	5820
B	420	1070
C	4110	6890
D	2320	3550
E	210	210
F	560	1000
G	650	1000
H	580	1000

*** Note:**
Plant centres greater than 1m are possible with custom order lengths of 5" tubing, please contact tech@alienhydroponics.co.uk for more details.



Project: V-SYSTEM	Scale 1 : 24
Title: 4 Row 24 Pot	
Drawing Number: V-4.24	Sheet 1 of 1