

1. Part Number: A926-8

2. Photograph:

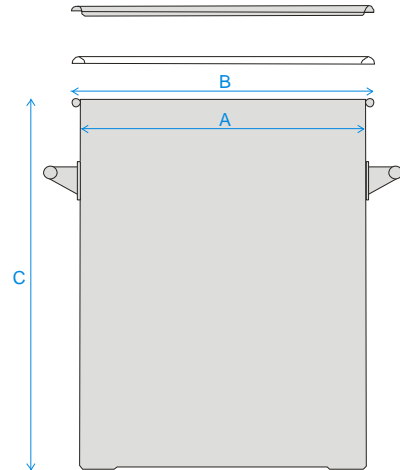

3. Product Information:

Description

Toggle Drum 8L

Materials of Construction:

- Body: 316L stainless steel
- Lid: 316L stainless steel
- Toggles: 304 stainless steel
- Handles: 304 stainless steel
- Gasket: Silicone (FDA 177.2600 compliant & BSE/TSE free)

Nominal Volume:

8 Litres

Brimful Volume:

9 Litres

Method of Construction:

Welds ground and polished

Surface Finish:

Better than 0.5 microns Ra

Dimensions

A = 196 mm
B = 216 mm
C = 300 mm

Graduation Marks:

None

Handles:

2 side handles welded onto patch plates

Number of Toggles:

4

Weight:

3.2 Kg (body + gasket + lid)

BSE/TSE statement:

All polishing compounds used in the manufacture of this product are of vegetable origin.

Recommended Storage Conditions:

Dry and ambient temperature

4. Approval:

Signed:



Name: Kuldeep Flora

Position: Quality Manager

Date: 13-Oct-20



Sampling Systems Ltd.

4-5 Forge Mills Park, Coleshill, Warwickshire, B46 1JH, UK.

Tel: +44(0)1675 466992 Email: info@sampling.com Web: www.sampling.com