

**1. Part Number:** A926-20

**2. Photograph:**

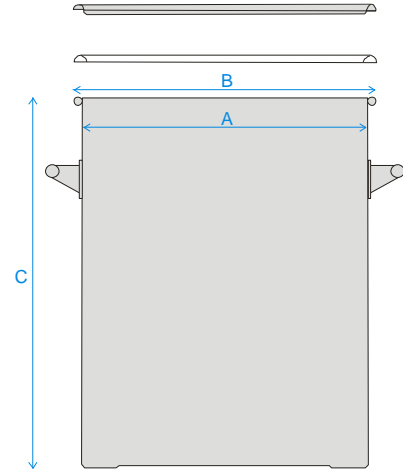

**3. Product Information:**

Description	Toggle Drum 20L
Materials of Construction:	<ul style="list-style-type: none"> <li>- Body: 316L stainless steel</li> <li>- Lid: 316L stainless steel</li> <li>- Toggles: 304 stainless steel</li> <li>- Handles: 304 stainless steel</li> <li>- Gasket: Silicone (FDA 177.2600 compliant &amp; BSE/TSE free)</li> </ul>
Nominal Volume:	20 Litres
Brimful Volume:	21 Litres
Method of Construction:	Welds ground and polished
Surface Finish:	Better than 0.5 microns Ra
Dimensions	A = 300 mm B = 320 mm C = 300 mm
Graduation Marks:	None
Handles:	2 side handles welded onto patch plates
Number of Toggles:	4
Weight:	5.5 Kg (body + gasket + lid)
BSE/TSE statement:	All polishing compounds used in the manufacture of this product are of vegetable origin.
Recommended Storage Conditions:	Dry and ambient temperature

**4. Approval:**

Signed:



Name: Kuldeep Flora

Position: Quality Manager

Date: 13-Oct-20



**Sampling Systems Ltd.**

4-5 Forge Mills Park, Coleshill, Warwickshire, B46 1JH, UK.

Tel: +44(0)1675 466992 Email: info@sampling.com Web: www.sampling.com