

1. Part Number: A196-05

2. Photograph:

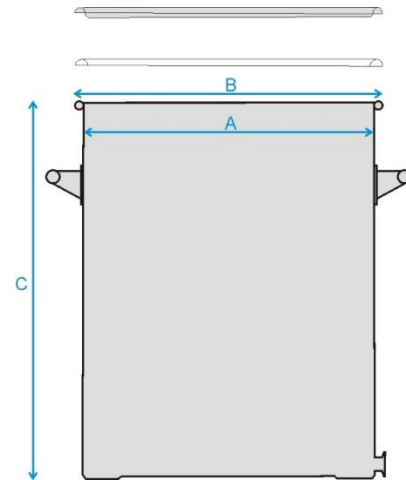

3. Product Information:

Description	Stainless Storage Drum 5L with 1" Ferrule
Materials of Construction:	<ul style="list-style-type: none"> - Body: 316L stainless steel - Ferrule: 316L stainless steel - Lid: 316L stainless steel - Clamp: 304 stainless steel - Handles: 304 stainless steel - Gasket: Silicone (FDA 177.2600 and USP Class VI compliant)
Nominal Volume:	5 Litres
Method of Construction:	Welds ground and polished
Surface Finish:	Better than 0.5 microns Ra
Dimensions	A = 196 mm B = 216 mm C = 200 mm
Graduation Marks:	None
Ferrule:	1" (to standard BS4825-3)
Ferrule location	25mm from base to underside of ferrule
Handles:	2 side handles welded onto patch plates
Weight:	2.8 Kg (body + gasket + lid + clamp)
BSE/TSE statement:	All polishing compounds used in the manufacture of this product are of vegetable origin
Recommended Storage Conditions:	Dry and ambient temperature
Note:	This product should be thoroughly cleaned before it is used for the first time

4. Approval:

Signed:



Name: Kuldeep Flora

Position: Quality Manager

Date: 2-Mar-22



Sampling Systems Ltd.

4-5 Forge Mills Park, Coleshill, Warwickshire, B46 1JH, UK.
 Tel: +44(0)1675 466992 Email: info@sampling.com Web: www.sampling.com