

MODENO

York Fire Bowl / Newbridge Fire Bowl

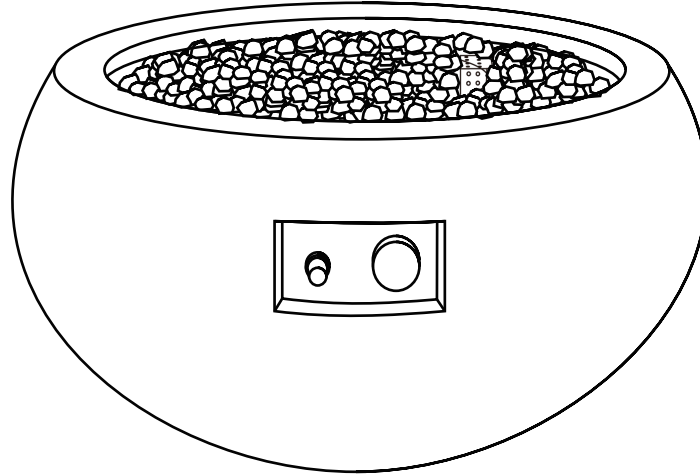

OFG115LP / OFG138LP

Owner's Manual
Gas Type: Propane

IMPORTANT

INSTALLER:
Leave this manual with the appliance.
CONSUMER:
Retain this manual for future reference.

WARNING

Do not store or use gasoline or other flammable vapors and liquids, in the vicinity of this or any other appliance. An LP-cylinder not connected for use should not be stored in the vicinity of this or any other appliance.

WARNING

• If the information in this manual is not followed exactly, a fire or explosion may result causing property damage personal injury or loss of life.

- Installation and service must be performed by a qualified installer, service agency or gas supplier.
- Improper Installation, adjustment, alteration, service or maintenance can cause injury or property damage.
- Read the installation, operation and maintenance instructions thoroughly before installing or servicing this equipment.
- Save these instructions for future reference. If you are assembling this unit for someone else, give this manual to him or her to read and save for future reference.

DANGER

FIRE OR EXPLOSION HAZARD

If you smell gas:

- Shut off gas to the appliance.
- Extinguish any open flame.
- If odor continues, leave the area immediately.
- After leaving the area, call your gas supplier or fire department.

Failure to follow these instructions could result in fire or explosion, which could cause property damage, personal injury, or death.

WARNING

For outdoor use only
Installation and service must be performed by a qualified installer, service agency, or the gas supplier.



TABLE OF CONTENTS

Important Safety Information ----- 3

Propane (LP) Dangers and Warnings -----5

Hose & Regulator Assembly and Replacement -----7

Parts List -----8

Assembly Instructions ----- 9



Lighting Instructions -----13

Care and Cleaning -----14

Gas Component Checks ----- 15

Troubleshooting -----17

Warranty ----- 19

 DANGER	CARBON MONOXIDE HAZARD
	<p>This appliance can produce carbon monoxide which has no odor.</p> <p>Using it in an enclosed space can kill you.</p> <p>Never use this appliance in an enclosed space such as a camper, tent, car or home.</p>

 **WARNING:** This product can expose you to Carbon monoxide, which is known to the State of California to cause birth defects or other reproductive harm. For more information go to www.P65Warnings.ca.gov .

 **WARNING:** This product can expose you to Disononyl phthalate (DINP), which is known to the State of California to cause cancer. For more information go to www.P65Warnings.ca.gov .

 **WARNING:** This product can expose you to Butylbenzyl phthalate (BBP)/Di-n-butyl phthalate (DBP) , which is known to the State of California to cause birth defects or other reproductive harm. For more information go to www.P65Warnings.ca.gov .

 **WARNING:** This product can expose you to Lead/ Di(2-ethylhexyl)phthalate(DEHP) , which is known to the State of California to cause cancer and birth defects or other reproductive harm. For more information go to www.P65Warnings.ca.gov .

IMPORTANT SAFETY INFORMATION



WARNING FIRE TABLE IS FOR OUTDOOR USE ONLY

IF YOU SMELL GAS

- Shut off gas supply to the fire table.
- Extinguish any open flame.
- Do not try lighting any appliance.
- Do not touch any electrical switch; do not use any phone in your building.
- Immediately call your gas supplier from a neighbor's phone.
- Follow the gas supplier's instructions.
- If you cannot reach your gas supplier, call the fire department.

Installation and repair should be done by a qualified service person. The appliance should be inspected before use and at least annually by a qualified service person. More frequent cleaning may be required as necessary. It is imperative that the control compartment, burners, and circulating air passageways of the appliance are kept clean.

• **WARNING:** Failure to follow the dangers, warning and cautions in this manual may result in serious bodily injury or death, or in a fire or an explosion causing damage to property.

• **IMPORTANT NOTICE:** Read and understand all warnings and precautions prior to assembly and use of your gas fire table. Improper installation, adjustment, alteration, service or maintenance can cause injury or property damage.

• **NOTE:** The use and installation of this product must conform to local codes, or in the absence of local codes with the National Fuel Gas Code, ANSI Z223.1 • NEPA 54; Natural Fuel Gas code ; Natural Gas and Propane Installation Code, CSA B149.1; or Propane Storage and Handling code B149.2; This appliance complies with ANSI Z21.97-2017• CSA2.41-2017 Outdoor Decorative Gas Appliances Standards.

• **Minimum Clearance from Unit to Combustible Materials**

72”(182.9cm) minus the height of appliance from the top; 48” (121.9cm) from all sides and back.

• Do not locate this fire table under any overhead enclosure.

• The minimum inlet gas supply pressure: 25 PSI.

The maximum inlet gas supply pressure: 250 PSI.

• Keep these instructions for future reference. If you are assembling this unit for someone else, give this manual to him or her to read and keep for future reference.

• This gas fire table must be used **ONLY** outdoors in a well-ventilated space and shall **NOT** be used inside a building, garage, or any other enclosed area.

• **DO NOT** use this outdoor gas fire table for indoor heating. **TOXIC** carbon monoxide fumes can accumulate and cause asphyxiation.

• **NEVER LEAVE** this gas fire table unattended when in using.

• Children and adults should be alerted to the hazards of high surface temperatures and should stay away to avoid burns or clothing ignition.

• Do not store or use gasoline or other flammable vapors and liquids within 25 feet (7.62m) of this or any other appliance.

• Do not store any combustible materials in the base enclosure.

• The use of alcohol, prescription or non-prescription drugs may impair an individual's ability to properly assemble or safely operate this outdoor fire table.

IMPORTANT SAFETY INFORMATION

- DO NOT use in an explosive atmosphere. Keep gas fire table area clear and free from combustible materials, gasoline and other flammable vapors and liquids.
- This outdoor fire table is NOT to be operated by children. Young children should be closely supervised when in the vicinity of this outdoor fire table.
- This outdoor fire table is not to be installed or used in or on recreation vehicles and/or boats.
- Always use in accordance with all applicable local, state and national codes. Contact your local fire department for details on outdoor burning.
- Use the same precautions you would with any open fire when using this outdoor fire table.
- DO NOT burn solid fuels such as: wood, charcoal briquettes, lump charcoal, manufactured logs, driftwood, trash, leaves, paper, cardboard, plywood, painted or stained or pressure treated wood in this outdoor fire table.
- DO NOT use this outdoor fire table until it is COMPLETELY assembled and all parts are securely fastened and tightened.
- DO NOT store another LP gas tank within 10 feet (3.05 m) of this outdoor fire table while it is in operation.
- DO NOT use this outdoor fire table near automobiles, trucks, vans or recreational vehicles.
- DO NOT use this outdoor fire table under any overhead structure or near any unprotected combustible constructions. Avoid using near or under overhanging trees and shrubs.
- Always use this outdoor fire table on a hard, level non-combustible surface such a concrete, rock or stone. An asphalt or blacktop surface may not be acceptable for this purpose.
- DO NOT use this outdoor fire table if any part has been under water. Immediately call a qualified service technician to inspect the fire table and to replace any part or control system and any gas control which has been under water.
- DO NOT wear flammable or loose clothing when operating this outdoor fire table.
- DO NOT use in windy conditions.
- Keep all electrical cords away from a hot outdoor fire table.
- Certain areas of this outdoor fire table when in use will become too hot to touch. Do not touch hot surfaces until the unit has cooled unless you are wearing protective gear such as insulated pot holders or heat resistant gloves or mittens to avoid burns.
- DO NOT hang or place clothing or other flammable materials on or near the gas fire table.
- Any guard or other protective device removed for servicing the fire table must be replaced prior to operating the fire table.
- DO NOT attempt to move or store this outdoor fire table until all parts are cool.
- DO NOT lean over this outdoor fire table when lighting or when in using.
- Use only the regulator and hose assembly provided. The replacement regulator and hose assembly shall be that specified by the manufacturer.
- DO NOT attempt to disconnect the gas regulator from the tank or any gas fitting while the outdoor fire table is in using.
- Always shut off gas supply at the tank valve and disconnect regulator from the tank when the fire table is not in using
- DO NOT sit on the mantle when the unit is in operation.
- DO NOT throw anything onto the fire when the unit is in operation.
- Lava rocks are very hot; please keep the children or pets away at a safe distance.
- It is essential to keep the outdoor fire table valve compartment, burners, and circulating air passages clean. Inspect outdoor fire table before each use.
- Prior to each fire table operation, check the hose for evidence of excessive abrasion or wear by looking through the visual check hole. If the hose is damaged, cracked or cut, it must be replaced before using the gas fire table. The hose assembly can only be replaced with a hose assembly specified by the manufacturer.

IMPORTANT SAFETY INFORMATION

- Before each use, remove the lava rocks. Examine the burner and its components. If dirty, clean with a soft brush and soapy water solution. Examine the area around the burner; any dirt or foreign material, such as spider webs or nests in this area should be removed. If it is evident that the burner is damaged, the fire table must not be used. The burner assembly cannot be replaced. Please contact Ocean Rock USA at 800-678-7294 for technical support.
- Place the hose out of the pathways where people may trip over it. Do not place the hose in areas where it may be subjected to accidental damage.



WARNING

This outdoor fire table is for use with liquid propane (LP) gas only. The conversion to or attempted use of natural gas in this outdoor fire table is dangerous and could result in serious personal injury, or property damage.

ATTENTION: Any alteration of the outdoor fire table that is not specifically directed in the operations manual will void manufacturer warranty.

PROPANE (LP) DANGERS AND WARNINGS

LP Gas

LP gas is flammable and hazardous if handled improperly. Become aware of the characteristics before using any LP gas product.

Propane Characteristics

- Flammable, explosive under pressure, heavier than air and settles in pools in low areas.
- In its natural state, propane has no odor. For your safety, an odorant has been added.
- Contact with propane could burn your skin.
- Propane is extremely flammable and hazardous if handled improperly.

LP GAS WARNINGS

- Cylinders must be stored outdoors in a well-ventilated area out of reach of children.
- Disconnected cylinders must have threaded valve plugs tightly installed and must not be stored in a building, garage or any other enclosed area.
- Never use a propane cylinder with a damaged body, valve, collar or footing.
- Dented or rusted propane cylinders may be hazardous and should be checked by your propane gas supplier.
- Be sure to use only one 20 lb (9.1 kg) LP gas cylinder with a Type 1 valve with this appliance as required by the American National Standards Institute (ANSI) and the Canadian Standards steering Committee. Only tanks marked "propane" may be used.
- The LP gas supply tank must be constructed and marked in accordance with the specifications for LP gas LP gas tanks of the U.S. Department of Transportation (DOT) or the National Standard of Canada, CAN/CSA-B339, LP gas tanks, Spheres and Tubes for the Transportation of Dangerous Goods and Commission.
- LP gas tank must be arranged for vapor withdrawal.

PROPANE (LP) DANGERS AND WARNINGS

- The LP gas tank must have a tank collar to protect the tank valve.
- LP gas cylinder must contain a shut-o valve as specified in the Standard for Compressed Gas Cylinder Valve Outlet and Inlet Connection, ANSI/CGA-V-1-1977, CSA B96.
- The LP gas tank should not be dropped or handled roughly.
- Tanks must be stored outdoors out of the reach of children. Do NOT store in a building, garage, or any other enclosed area.
- Never store your LP gas tank where temperatures can reach over 125°F.
- Do not store the LP gas cylinder in direct sunlight or near a source of heat or combustion.
- Never keep a filled LP gas tank in a hot car or car trunk. Heat will cause the gas pressure to increase, which may open the relief valve and allow gas to escape.
- Place dust cap on valve outlet whenever the LP gas tank is not in use. Only install the type of dust cap on the LP gas tank valve outlet that is provided with the LP gas tank valve. Other types of caps or plugs may result in leakage of propane.
 - a. Do not store a spare LP gas cylinder under or near this appliance.
 - b. Never fill the LP gas cylinder beyond 80% full.
 - c. If the information in (a) and (b) is not followed exactly, a fire causing death or serious injury may occur.
- LP gas cylinders should be filled only by a certified LP gas dealer.
- The pressure regulator is set for 11 inches of water column (pressure).
- The maximum inlet gas pressure for this outdoor fire table is 14 inches of water column pressure.
- Never attempt to attach this appliance to the self-contained LP gas system of a camper trailer, motor home or house.
- Always use the pressure regulator and hose assembly provided with the appliance to connect to a LP gas cylinder. Never connect to an unregulated LP gas supply. For technical support contact Ocean Rock USA at 800-678-7294.
- Hand turn the manual gas control valve. Never use tools. If the valve will not turn by hand, do not try to repair it. Call a Certified Gas Technician. The use of force or any self attempted repair may result in a fire or explosion.



















Connecting your gas cylinder

Before connection, be sure that there is no debris caught in the head of the gas cylinder, head of the regulator valve or in the head of the burner and burner ports. Connect regulator valve and hand-tighten firmly. Disconnect the propane cylinder from the regulator valve when the fire table is not in use. DO NOT obstruct the flow of combustion air and ventilation air to the burner.

HOSE & REGULATOR ASSEMBLY AND REPLACEMENT

1. This fireplace comes equipped with a standard LP gas hose and regulator including the appliance side connection for a CGA No 791 Cylinder Connection Device. The LP gas hose and regulator supplied with this fire table must be used. Only a hose and regulator specified by manufacturer can be used for replacement.
 - a. The CGA No 791 connection incorporates a magnetic flow limiting device that acts to limit the flow of gas if a leak is detected between the regulator and the burner valve.
 - b. If the burner valve is open prior to the LP gas cylinder service valve being opened, the connection will interpret this free flow of gas to be a leak.
 - c. The connection safety feature will reduce gas flow from the regulator to the appliance to a minimal level.
 - d. Be sure that the burner control valve is closed prior to opening the LP gas cylinder service valve to ensure that the connection flow limiting device is not triggered mistakenly.
 - e. If the connection flow limiting device is triggered mistakenly, close the LP gas cylinder service valve and the burner valve, wait 10 seconds to allow the device to reset, open the cylinder service valve, then open the burner valve and light the fireplace as per lighting instructions.
2. Be sure to protect the hose from any hot surfaces. Serious danger may result if the hose contacts any hot surface
3. Regular maintenance of the hose and regulator:
 - a. Inspect the hose before each use of the fire table. If the hose shows signs of cracks, abrasions, cuts or damage of any kind, do not operate the appliance. Fix or replace the hose as required before using the appliance. For assistance with repair or replacement of the hose, call Ocean Rock USA at 800-678-7294. Use only replacement parts from the manufacturer.
 - b. Inspect the seal inside the CGA No 791 service valve on the LP gas cylinder when replacing the cylinder or at least once per year. If there is any indication of damage, have the seal replaced by a certified gas dealer before operating the appliance.
4. Do not use tools to tighten the CGA No 791 connection nut onto the LP gas cylinder service valve. Hand tighten only.
5. Be careful to not cross the threads on the connection when tightening the CGA No 791 connection on to the LP gas cylinder service valve.
6. "Leak Test" should always be performed after attaching the connection to the LP gas cylinder service valve. (See "Checking for Leaks" section of this manual on page 12)
7. For the connection of the hose and regulator to the LP tank, refer to the "Connection" section of the LP gas cylinder section above.

PARTS LIST

Item	Picture	Description	Qty.
01		Burner Ring	1 pc
02		Guard	1 pc
03		Fire bowl	1 pc
04		Orifice	1 pc
05		Valve	1 pc
06		Ignitor	1 pc
07		Control Knob	1 pc
08		Thermocouple	1 pc
09		Electrode	1 pc
10		Ground wire	1 pc
11		Corrugated Pipe	1 pc
12		Control Panel	1 pc
13		LP Regulator and Hose	1 pc
14		Battery	1 pc
15		Lava Rock	6 kgs
16		Cover	1 pc
17		Fire Pit	1 pc
18		Tank seat	1 pc
19		Touch up kit	1 pc

! WARNING
 For technical support or replacement parts or missing parts please contact Ocean Rock USA at 800-678-7294.

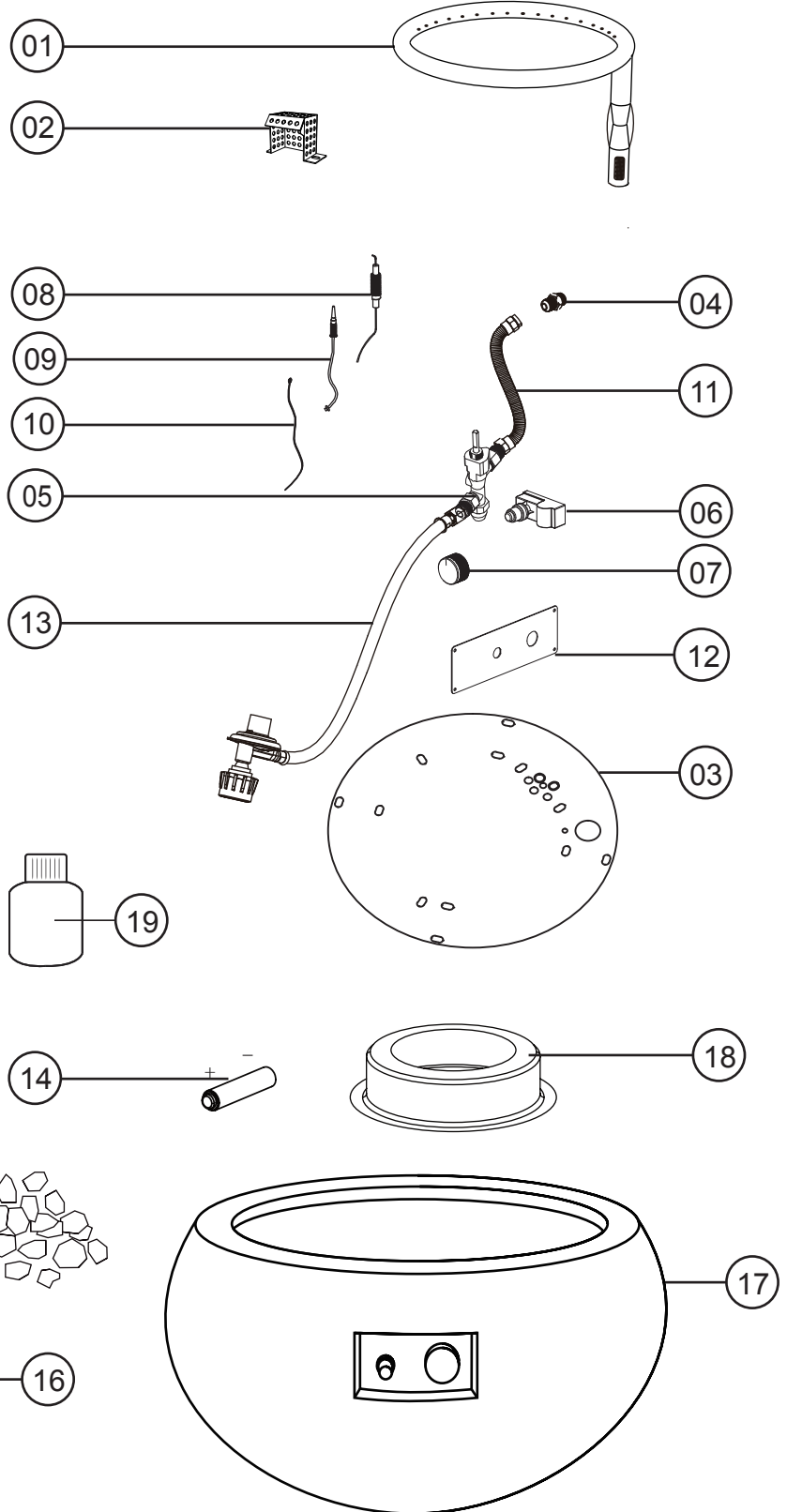

ASSEMBLY INSTRUCTIONS

1

Make sure the gas supply system is turned to "OFF".
Install the AAA battery as shown in the diagram below.

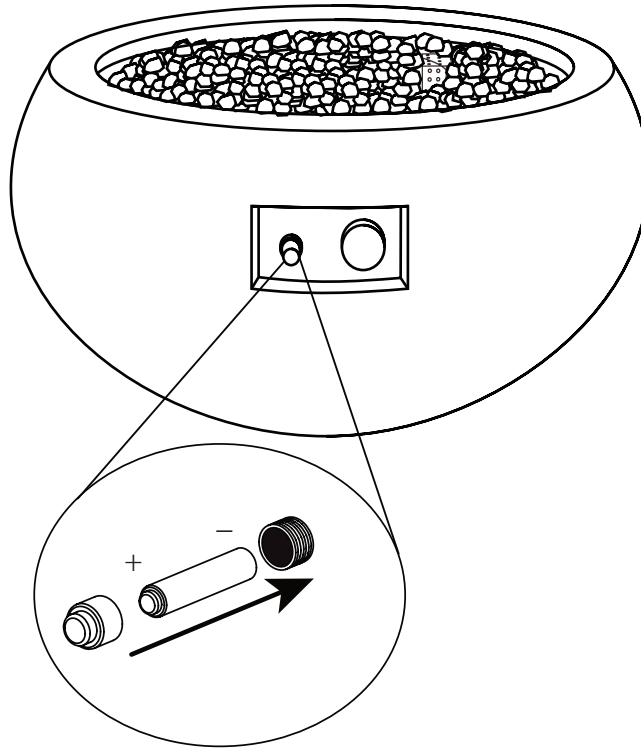

1. Place the tank seat on the ground and place a 20 lb. propane tank into the tank seat.
2. Tighten down the screw on the side of the tank seat to secure the propane tank.

2

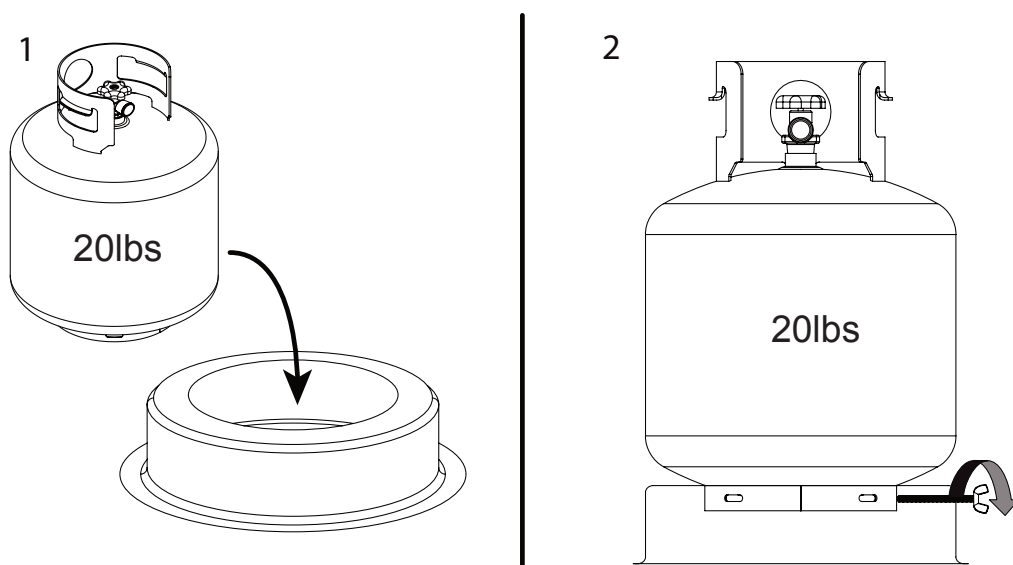

ASSEMBLY INSTRUCTIONS

3

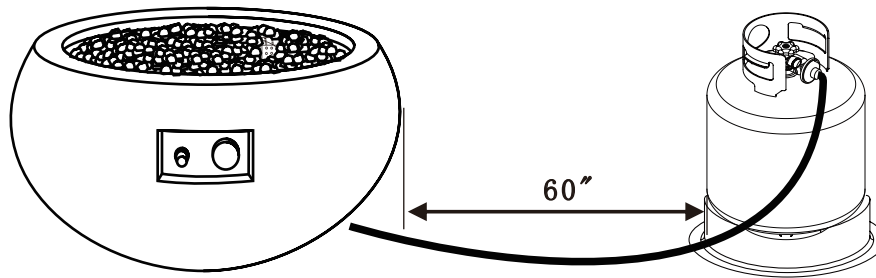

WARNING

Fire Pit must be 60 inches away from the Gas Tank.
Pay attention to the tipping hazard!

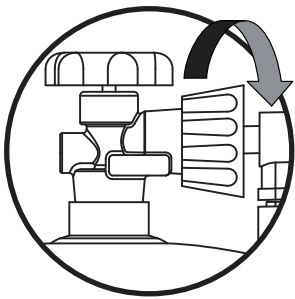

Connecting the LP Gas Tank

Check to make sure there is no debris in the head of the LP gas tank or in the head of the regulator valve. Make sure you check the burner and burner ports as well.

Connect gas line to tank by turning knob clockwise. Hand tighten only.

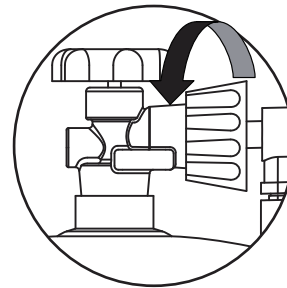

Disconnecting the LP Gas Tank

Make sure the valve on the LP gas tank is OFF.

Disconnect by turning the knob counter clockwise until it is detached from the valve.

Provided with a listed overfilling prevention device; and provided with a cylinder connection device compatible with the connection for the appliance.

ASSEMBLY INSTRUCTIONS

4

Place lava rock by hand. DO NOT dump bag out into tray to avoid clogging the burner with dust. Position the lava rock to a level about 1" above the top of the burner. Make sure that you do not block the igniter box with lava rock to ensure proper ignition.

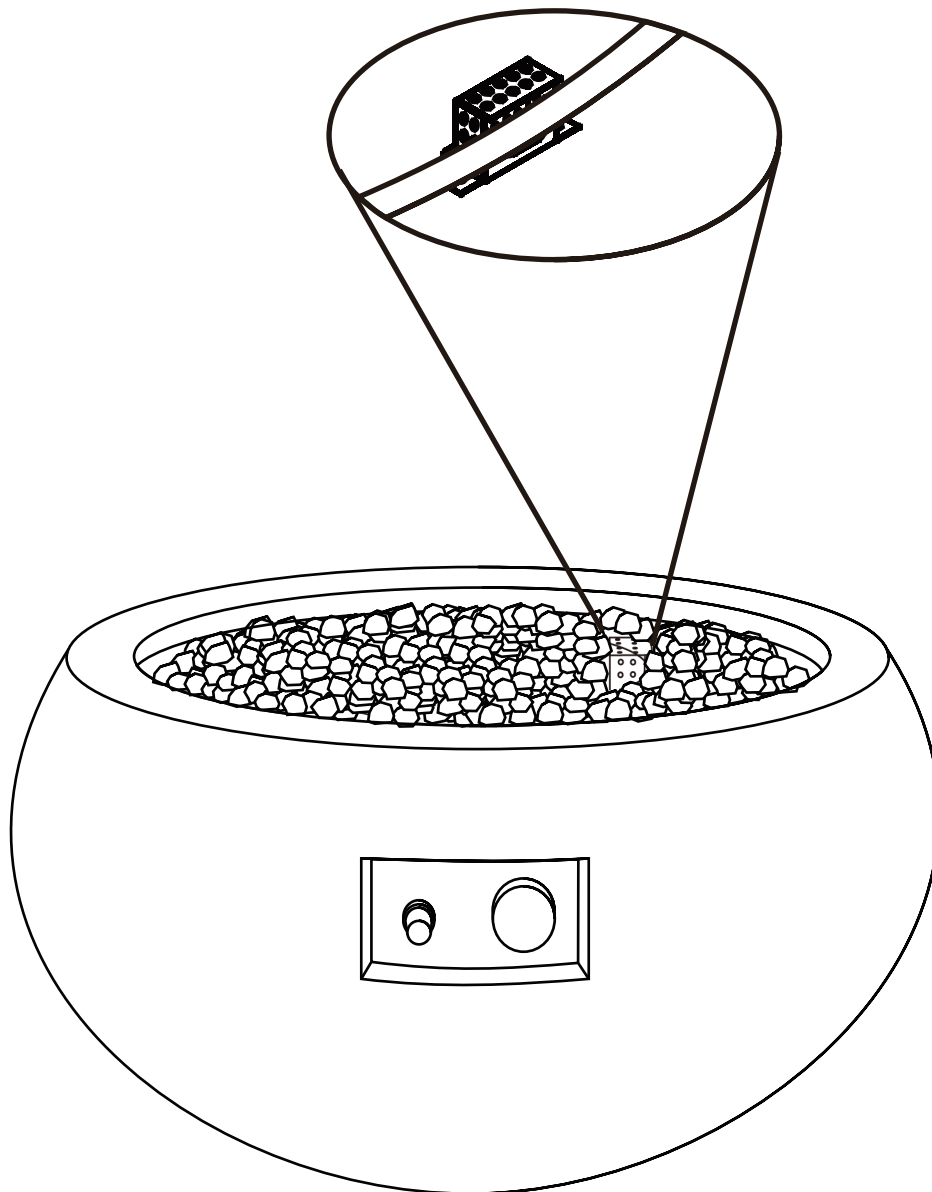

PRE-USE INSTRUCTIONS



WARNING Before using this outdoor fire table, make sure you have read, understand and are following all information provided in the Important Safety Information section of this manual. Failure to follow those instructions can cause death, serious injury or property damage.

Prior to each gas fireplace operation, check the hose and valve for evidence of excessive abrasion or wear through the visual check hole on the side of the base. Replace visual check cap prior to operating fireplace.

BURNER CONNECTIONS

Make sure the regulator valve and hose connections are securely fastened to the burner and the tank. If your unit was assembled for you, visually check the connection between the burner pipe and orifice. Make sure the burner pipe fits over the orifice.

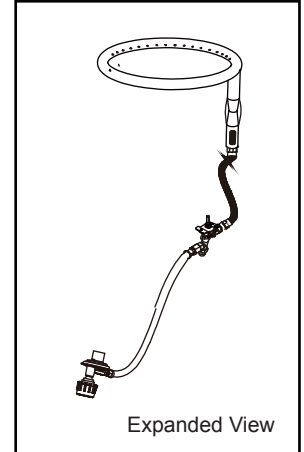

WARNING

Failure to inspect this connection or follow these instructions could cause a fire or an explosion. Failure to position the parts in accordance with these diagrams or failure to use only parts specifically approved with this appliance may result in property damage or personal injury.

Please refer to diagram for proper installation.

If the burner pipe does not rest flush to the orifice please contact Ocean Rock USA at 800-678-7294 for assistance.

CHECKING FOR LEAKS

Make a leak check solution by mixing 1 part dish washing soap with 3 parts water in a spray bottle. Make sure control knob is "OFF." Then, turn LP gas tank to "ON" at valve.

Spray leak solution on valve connections paying particular attention to the areas indicated by arrows. If any bubbles appear turn LP gas tank OFF, reconnect and re-test. If you continue to see bubbles after several attempts, disconnect LP gas source and contact Ocean Rock USA at 800-678-7294 for assistance. If no bubbles appear after one minute turn tank OFF, wipe away solution and proceed.

Orifice is located in this connection

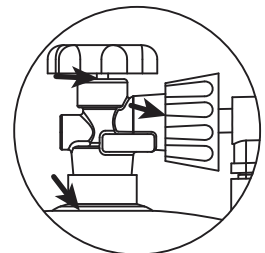
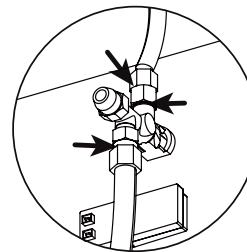
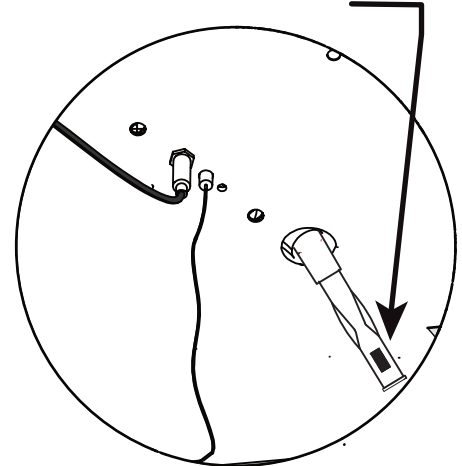

Check for leaks at these locations

LIGHTING INSTRUCTIONS

Using the Ignitor

1. Read instructions before lighting.
2. Control knob must be in the "OFF" position.
3. Connect propane cylinder (See Manual), slowly open valve on LP gas cylinder.
4. Push and hold igniter button to create sparks.
5. While holding the igniter button with one hand, use your other hand to push and turn the control knob to the "LOW" position to light the burner.
6. If ignition does not occur in 5 seconds, push and turn the Control Knob to "OFF", wait 5 minutes and allow gas to dissipate.
7. Once the burner is lit, continue to hold the knob in for another 20 seconds and release.
8. Observe flame, make sure all burner ports are lit. Flame height should be no higher than 13 inches tall.
9. Adjust flame to desired flame with the control knob.



Keep the lava rock covered and make sure it is dry before igniting.

Using a Long Match or Lighter

1. Prior to lighting, use a shovel to move lava rocks for access to the burner.
2. Wearing heat resistant gloves, position the burning long match or burning butane lighter near the side of the burner. DO NOT lean over the fire table while lighting!
3. Turn control knob counterclockwise to "LOW".
4. Remove long match/long butane lighter.
5. After lighting, use a shovel and heat resistant gloves to carefully move the lava rocks back into their proper position.
6. Observe flame, make sure all burner ports are lit. Flame height should be no higher than 13 inches tall.
7. Adjust the flame to the desired height with the control knob.



WARNING

When using this method to light your fire table use heat resistant gloves and follow the step by step instructions. Failure to do so could result in severe injury.



WARNING

If burner flame goes out during operation, immediately turn the control knob "OFF" and let the gas clear a minimum of 5 minutes before attempting to re-light the fire table.

Please refer to the trouble shooting pages for additional support, beginning on page 17.

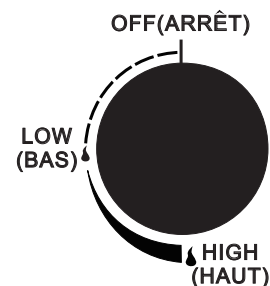

TURNING OFF

1. Turn and push the control knob clockwise to the "OFF" position.
2. Turn the cylinder valve on the gas tank to clockwise to close.

CARE AND CLEANING

Inspecting

This outdoor fire table must be inspected regularly to insure that the product is safe to use and to extend product life.



WARNING

DO NOT inspect this outdoor fireplace until the fire is COMPLETELY out.

1. Check the burner to make sure it is securely in place.
2. Check the air mixer to make sure it is clear and free of insects, spider nests and other debris(see picture).
3. Check all gas connections for leaks.
4. Check ignition system to insure proper sparking.
5. Check components for any signs of damage, rust or excessive wear.
6. If damage to any component is detected, DO NOT operate until the proper repairs have been made.

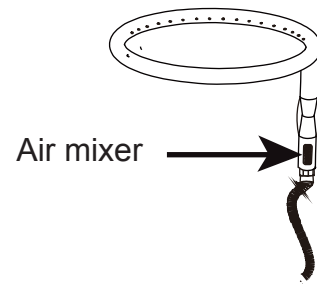

WARNING

DO NOT tamper with this appliance. This is DANGEROUS and will void the warranty. Any part found to be faulty must be replaced with an approved part, confirmed by manufacturer. For technical support contact Ocean Rock USA at 800-678-7294.

General Care and Cleaning

This outdoor fireplace should be cleaned regularly to ensure safe use and extend product life.

Note: After repeated use, a slight discoloration of the finishes may occur.

Table

1. Wipe exterior surfaces with a mild dish washing soap or baking soda, then rinse clean with water.

Stainless Steel

1. For general cleaning use warm water, soap, ammonia, or detergent apply with a soft cloth or Sponge
2. For finger prints or smears use 3M Stainless Steel Cleaner and Polish, Arcal 20, Lac-O-Nu, LuminWash, O'Cedar Cream Polish, or Stainless Shine, this will provide a barrier file to minimize fingerprints.
3. For stubborn stains and discoloration use 3M Stainless Steel Cleaner and Polish, Allchem Concentrated Cleaner, Samae, Twinkle, Cameo Copper Cleaner, Liquid Nu Steel, Copper's or Revere Stainless Steel Cleaner, apply using a soft cloth in the same direction of the polish lines.
4. While using in salt air environments we recommend cleaning all stainless steel surfaces at least every two weeks to keep the item in prime condition. Stainless steel is corrosion-resistant but it is not impervious to rust. Exposure to salt air and sea spray will cause surface rust if you do not care for your products properly. The best thing you can do to protect the stainless steel is to clean it frequently.

* Use of proprietary names is intended only to indicate a type of cleaner and does not constitute endorsement. Omission of any proprietary cleanser does not imply its inadequacy. All products should be used in strict accordance with instructions on package.

Storage



WARNING

DO NOT move or store this fire table unless the fire is COMPLETELY out and cool to the touch.

1. Turn gas OFF at tank connection. Remove tank and store in a cool, dry location outdoors, away from children.
2. Carefully remove rock filler and store components flat to protect them from breakage.
3. ALWAYS cover your outdoor fire table when not in use.
4. Store in a cool, dry location away from children and pets.

GAS COMPONENT CONNECTION CHECKS

If the burner will not light or stay lit, please perform the following checks.

1. Make sure the electrode wire is correctly connected. Both electrode wires must be fully inserted into the igniter box.

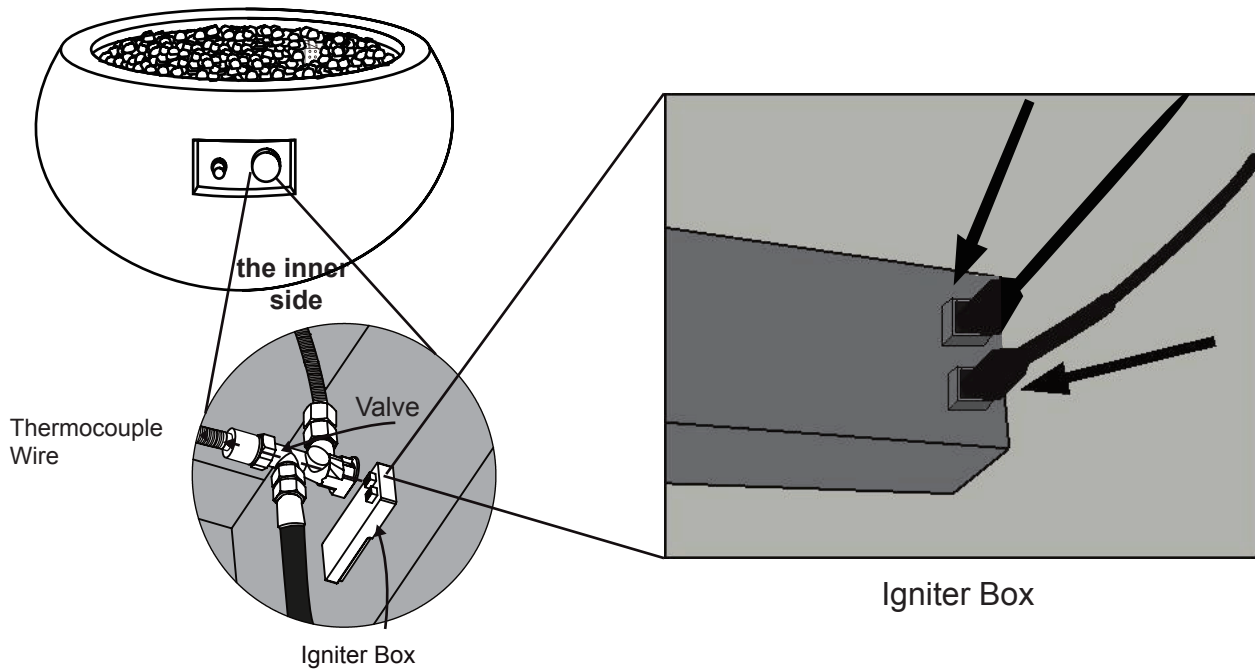

2. Make sure that the pilot housing is unobstructed.

Clear any debris on top of the pilot housing and make sure there is no debris between the igniter pin, thermocouple and the burner tube.



CORRECT



INCORRECT

GAS COMPONENT CONNECTION CHECKS

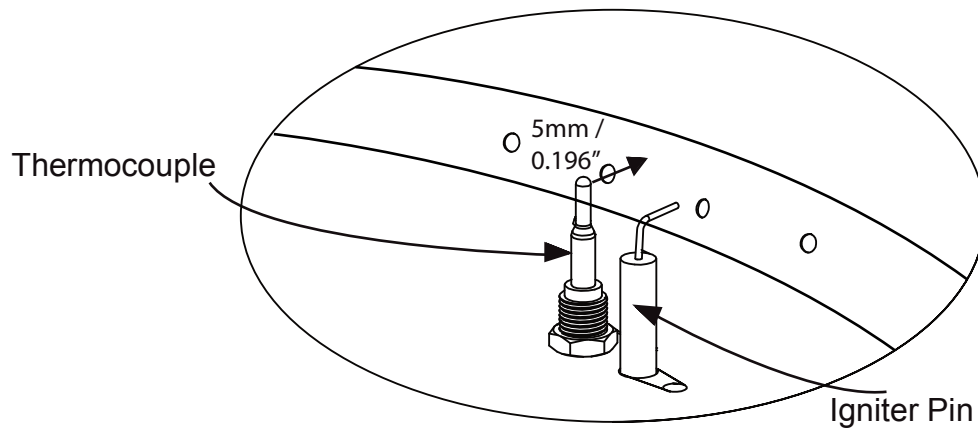

3. Make sure that the igniter pin and thermocouple are correctly positioned.
- The igniter pin should be pointed straight to the thermocouple.
 - The thermocouple should be positioned 5mm / 0.196" away from the burner tube.

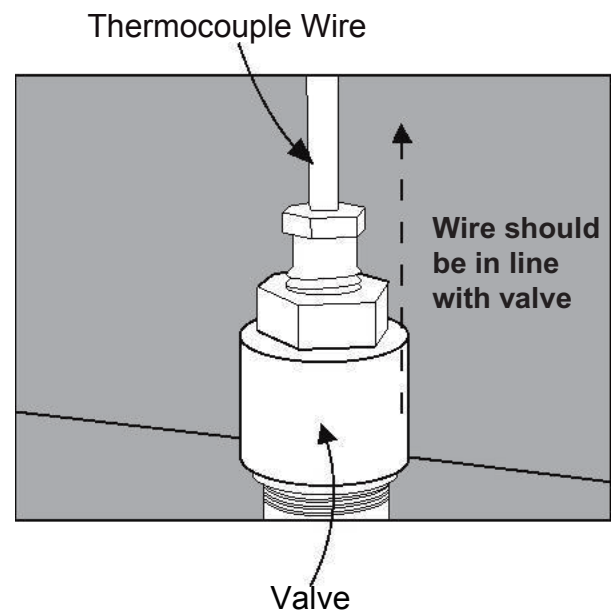
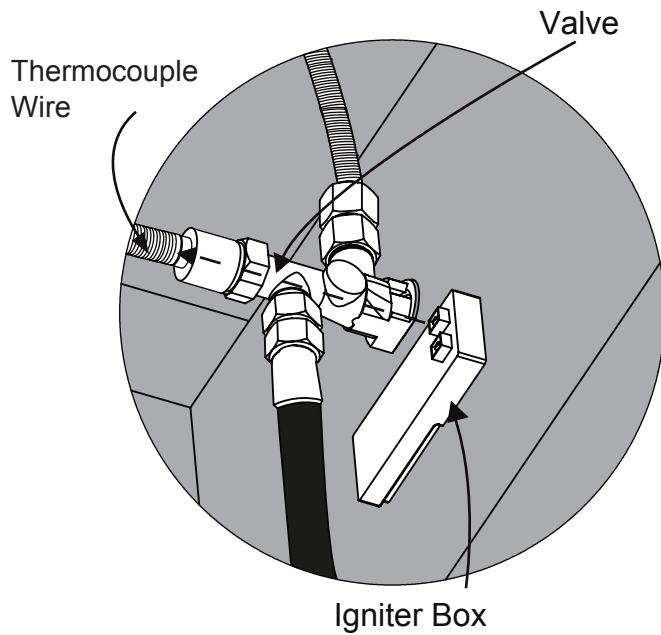

4. Make sure that the thermocouple wire is correctly positioned. The thermocouple wire should be in line with the valve.

TROUBLESHOOTING

Problem: Burner will not light using igniter

Possible Cause 1: Electrode and burners are wet.

-Wipe dry with cloth.

Possible Cause 2: Igniter battery is dead or backwards.

-Check that the AAA battery is inserted correctly in the igniter (see page 9) or replace the battery.

Possible Cause 3: Igniter Pin cracked or broken - sparks at crack.

-Call Ocean Rock USA at 800-678-7294 for technical support.

Possible Cause 4: Wire loose or disconnected.

-Reference page 15, step 1, reconnect wire. Call Ocean Rock USA at 800-678-7294.

Possible Cause 5: Wire is shorting (sparking) between igniter and electrode.

-Call Ocean Rock USA at 800-678-7294 for support.

Possible Cause 6: Bad Igniter.

-Call Ocean Rock USA at 800-678-7294 for supporting.

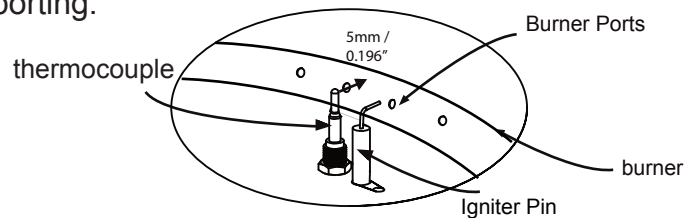

Problem: Burner will not light with match

Possible Cause 1: No Gas Flow.

-Check if the LP gas tank is empty. If empty, replace and refill. If the propane tank is not empty, refer to "Problem: Sudden drop in gas flow" on the following page.

Possible Cause 2: Coupling nut and regulator not fully connected.

-Turn the coupling nut about one half to three fourths a turn, until you feel a solid stop. Do not use tools, tighten by hand only.

Possible Cause 3: Obstruction of gas flow.

- Check for bent or kinked hose.

Possible Cause 4: Spider webs or insect nest in the Air mixer.

- Clean the Air mixer.

Possible Cause 5: Burner ports clogged or blocked.

-Reference "Problem: Irregular flame pattern" on the following page. Clean the burner ports as described there.

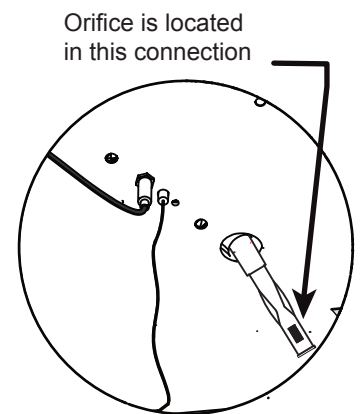

Problem: The Fire Table emits a lot of black smoke when in use

Possible Cause 1: Hose from gas fireplace is pinched.

-Make sure the hose is not pinched between the fire table and the source of the gas.

Possible Cause 2: Flame is being obstructed at burner ports.

-Make sure that the gas ports on the burner are free of any lava rocks so that the flame can flow naturally.

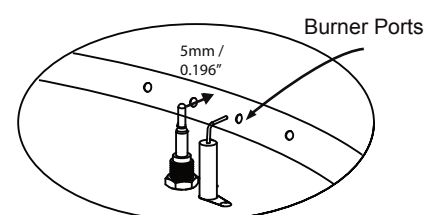

TROUBLESHOOTING

Problem: Sudden drop in gas flow, or a reduced flame height

Possible Cause 1: Out of gas.

-Refill your LP tank.

Possible Cause 2: Excess flow safety device may have been activated.

-Turn control knob to "OFF", wait 30 seconds and light outdoor fireplace. If flames are still too low reset the excessive flow safety device by turning off the control knob and LP gas tank valve.

Disconnect regulator. Turn burner control knob to "HIGH". Wait 1 minute. Turn burner control knob off. Reconnect regulator and perform a leak check at tank connection. Turn LP gas tank valve on slowly, wait 30 seconds and then light outdoor fire table.

Problem: Irregular flame pattern, flame does not run the full length of the burner

Possible Cause: Burner ports are clogged or blocked.

-Clean burner ports. Do this by inserting a paperclip into each of the burner ports to ensure they are not clogged.

WARNING: Make sure burner is not on and the gas supply has been properly disconnected. Allow 15 minutes for unit to cool before touching it.

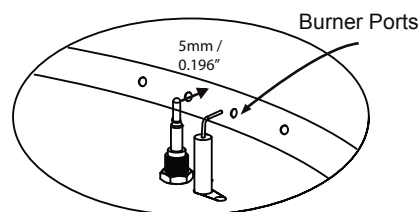

Problem: Flame blow out

Possible Cause 1: High or gusting winds.

-Increase flame to "HIGH" setting.

Possible Cause 2: Low on LP gas.

-Replace or refill LP gas tank.

Possible Cause 3: Excess flow valve tripped.

-Refer to "Problem: Sudden drop in gas flow".

Problem: Flame seems to lose heat when burning in cold weather- temperature below 50°F

Possible Cause 1: Ice has built up on the outside of the LP gas tank because the vaporization process is too low.

-Turn the control knob and the LP gas tank to "OFF". Replace with a spare LP gas tank and resume burning. Store the spare LP gas tank in a well ventilated area, away from children

Warranty

Ocean Rock USA INC. warrants fire features and accessories to be free from defects in parts and workmanship under normal use and service for a period of 1 year from the date of purchase. In the event of such defects Ocean Rock will, at its option, repair or replace the defective product. The foregoing is at the discretion of Ocean Rock.

There will be no charge for the replacement parts or product, however it will be the consumer's responsibility to return the product to the original place of purchase.

Ocean Rock will not be responsible for consequential damages in excess of the purchase price of the product on which such liability is based and the warranty does not cover costs including freight, removal and reinstallation.

This warranty is non-transferable and applies only for units that are for non-commercial personal use only.

Under this warranty agreement, all gas lines must be installed by a licensed gas fitter.

Damage caused by shipping, staining and abuse are not covered under this warranty. Dings, dents and scratches, fading and natural weathering are not covered under this warranty. Decorative rock is not covered under this warranty. Improper installations, repair or modifications made by anyone other than Ocean Rock will void this warranty and any damage caused by such is also not covered under this warranty.

Minor chipping, weather fading, water staining and non-structural hairline cracks are typical of the material of this product and are not covered under this warranty. Some color and texture variation is typical of the material and finish for this product and is not covered under this warranty.

Cast concrete is a hand finished process. As such, this product's finish will vary by unit. There will be a color variance of up to 15% in each unit. There may also be uneven texture or pattern as well as small holes in the surface caused by air or water trapped on the surface during casting. This is a normal trait of cast concrete and is not covered under warranty.

MODENO

Ocean Rock USA INC.

692 Parkridge Ave Norco, CA 92860, USA

www.oceanrockusa.com

info@oceanrockusa.com

Tel: 800-678-7294