

Replacement parts list



500, 9e Avenue
Richmond (Quebec) J0B 2H0
Phone : (888) 854-1111
Fax : (819) 826-6370



TABLE OF CONTENTS

Current models

MINI BTH

Models from 3 to 12 kW : 208/240V (Single phase)	4
--------------------------------------------------------	---

MINI ULTRA

Models from 3 to 12 kW : 208/240V (Single phase)	5
--------------------------------------------------------	---

BTH ULTRA

Models from 12 to 24 kW : 208/240V (single phase)	6
---------------------------------------------------------	---

Models from 27 to 36 kW : 208/240V (single phase)	7
---------------------------------------------------------	---

Models from 7 to 36 kW : 208/240V (3 phases)	8
----------------------------------------------------	---

Models from 7 to 36 kW : 480/600V (3 phases)	9
----------------------------------------------------	---

VOLTMAX

Models from 30 to 180 kW : 480/600V (3 phases)	10
------------------------------------------------------	----

Models from 192 to 408 kW : 480/600V (3 phases)	12
-------------------------------------------------------	----

AltSource

Power capacity from 4.5 kW to 29 kW : 208/240V (single phase)	15
---------------------------------------------------------------------	----

COMBOMAX ULTRA

Power capacity from 4.5 kW to 29 kW : 208/240V (single phase)	16
---------------------------------------------------------------------	----

COMBOMAX 109 COMMERCIAL

Power capacity from 6 kW to 30 kW : 240V (single phase)	17
---------------------------------------------------------------	----

Power capacity from 9 kW to 30 kW : 600V (3 phases)	18
-----------------------------------------------------------	----

TurboMax

Models 23, 24, 33, 34, 43, 44, 45, 65, 65A, 109 and 109A	19
----------------------------------------------------------------	----

DoubleMax

Models 50-4, 80-5 and 120-9	20
-----------------------------------	----

BuffMax

Models 30, 50, 80, 120, 120A, 175A, 200A	21
------------------------------------------------	----

VenTum

Modèles 40 et 60	22
------------------------	----

TABLE OF CONTENTS

Previous models

MINI BTH (2014 models and less)

Models from 3 kW to 12 kW : 208/240V (single phase)	23
-----------------------------------------------------------	----

BTH

Models from 8 kW to 33 kW : 240V (single phase)	24
Models from 9 kW to 36 kW : 600V (3 phases)	25

BTH ULTRA (2014 models and less)

Models from 6 kW to 33 kW : 240V (single phase)	26
-------------------------------------------------------	----

DTH

Models from 42 kW to 144 kW : 240V (single phase)	28
Models from 42 kW to 144 kW : 480/600V (3 phases)	28

INSTOMAX

Power capacity from 4.5 kW to 12 kW : 240V (single phase)	30
-----------------------------------------------------------------	----

COMBOMAX RESIDENTIAL

Models 23 to 64 with Power capacity from 8 kW to 24 kW : 240V (single phase)	31
------------------------------------------------------------------------------------	----

MINI BTH

Electric Boilers

Models from 3 to 12 kW : 208/240V (Single phase)

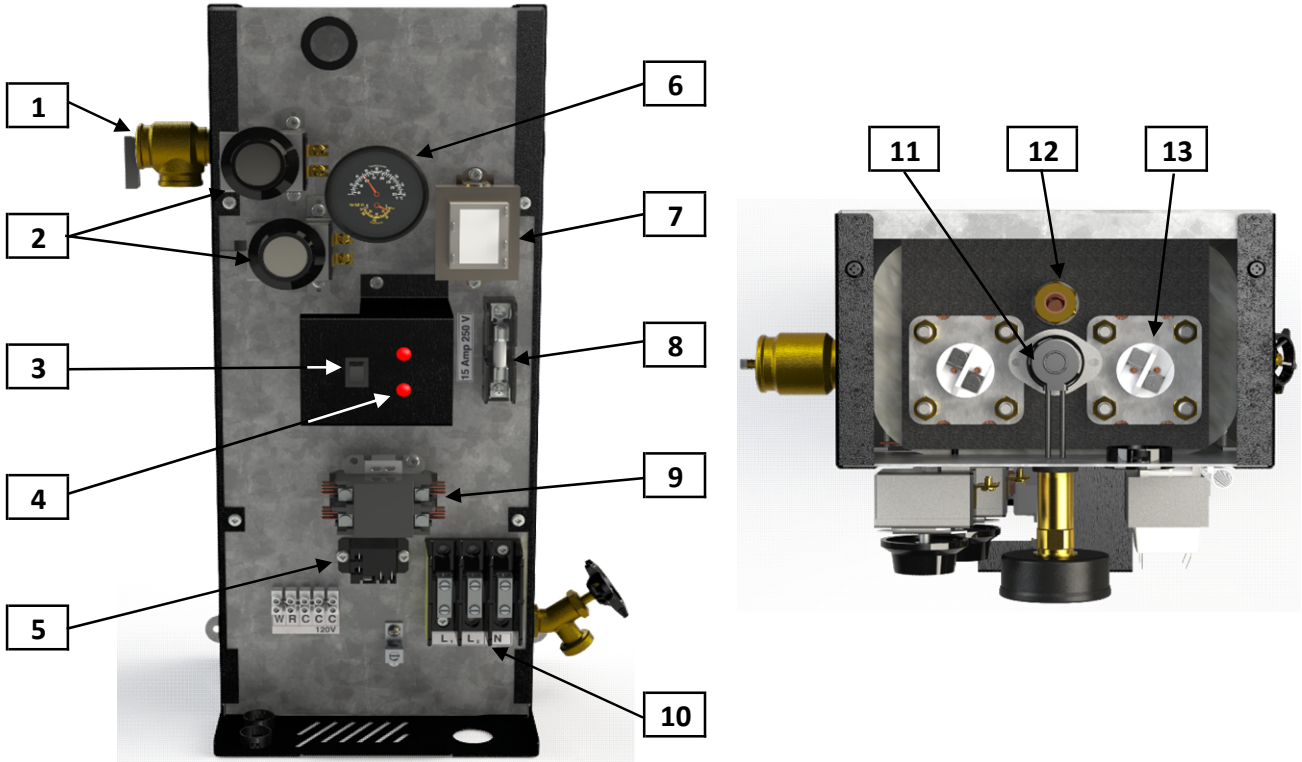

Item	Part number	Models	Description
1	ZMC200-SV30PSI1	All	Safety Valve 30 psi, 3/8"
2	ZEL200-G111781	All	Temperature control
3	ZEL900-ROCKER5A	All	On/Off Switch
4	ZEL150-240VRED	All	Indicating lamp
5	ZEL100-24ACSPST	All	Power relay 24Vac
6	ZMC300-75P160CN	All	Temperature and Pressure Indicator
7	ZEL400-20842440	All	Transformer 208V-240V/24V 40VA
8	ZEL250-TDCC15A	All	Time Delay Fuse 600V 15 Amp Class CC
9	ZEL100-2PC5024	3kW ; 4.5kW ; 7.5kW ; 9kW	2 poles Contactor 24Vac
	ZEL100-4P50A24	12kW	4 poles Contactor 24Vac
10	ZEL800-3P115600	All	Terminal Block 600V 3Poles 115A
11	ZEL200-L6C732	All	High-Limit automatic reset Switch
	ZMC100-3/8NPT	All	Well 3/8 NPT x 7 1/2"
12	ZMC100-1/2X5.9	All	Well 1/2 NPT x 5.9"
13	ZEL300-240V3KW	3kW ; 7.5kW	Heating element 3 kW 240V
	ZEL300-240V45KW	4.5kW ; 9kW	Heating element 4.5 kW 240V
	ZEL300-240V6KW	12kW	Heating element 6 kW 240V

MINI ULTRA

Electric Boiler

Models from 3 to 12 kW : 208/240V (Single phase)

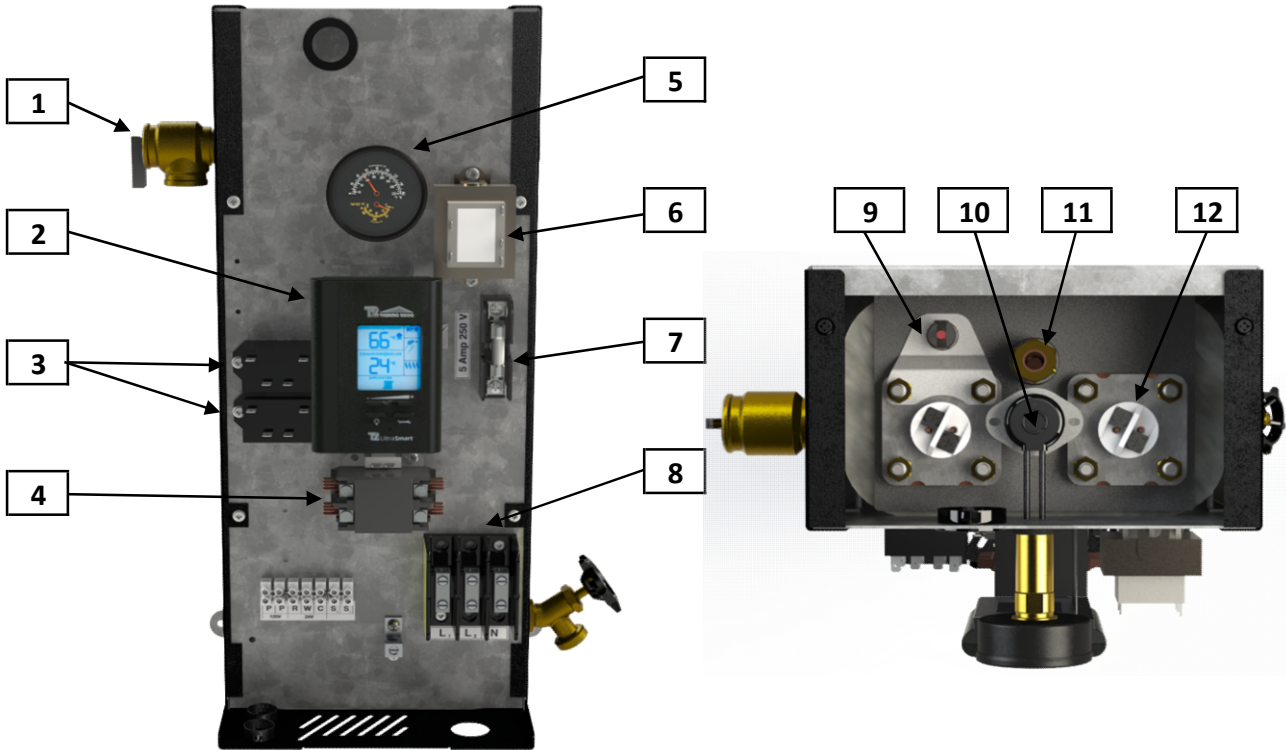

Item	Part number	Models	Description
1	ZMC200-SV30PSI1	All	Safety Valve 30 psi, 3/8"
2	ZEL100-ULTRA	All	UltraSmart Controller
3	ZEL100-24ACNO30	All	Power relay 24Vac
4	ZEL100-2PC5024	3kW ; 4.5kW ; 7.5kW ; 9kW	2 poles Contactor 24Vac
	ZEL100-4P50A24	12kW	4 poles Contactor 24Vac
5	ZMC300-75P160CN	All	Temperature and Pressure Indicator
6	ZEL400-20842440	All	Transformer 208V-240V/24V 40VA
7	ZEL250-TDMIDJ5	All	Fuse
8	ZEL800-3P115600	All	Terminal Block 600V 3Poles 115A
9	ZEL200-DISC227	USA models	Surface High-Limit
	ZEL200-L6C732	All	High-Limit automatic reset Switch
10	ZMC100-3/8NPT	All	Well 3/8 NPT x 7 1/2"
	ZEL100-SENSUNI	All	Boiler temperature sensor
11	ZMC100-1/2X37/8	All	Well 1/2 NPT x 3 7/8"
	ZEL300-240V3KW	3kW ; 7.5kW	Heating element 3 kW 240V
	ZEL300-240V45KW	4.5kW ; 9kW	Heating element 4.5 kW 240V
12	ZEL300-240V6KW	12kW	Heating element 6 kW 240V

BTH ULTRA 208/240V-1 ph.

Electric Boiler

Models from 12 to 24 kW : 208/240V (single phase)

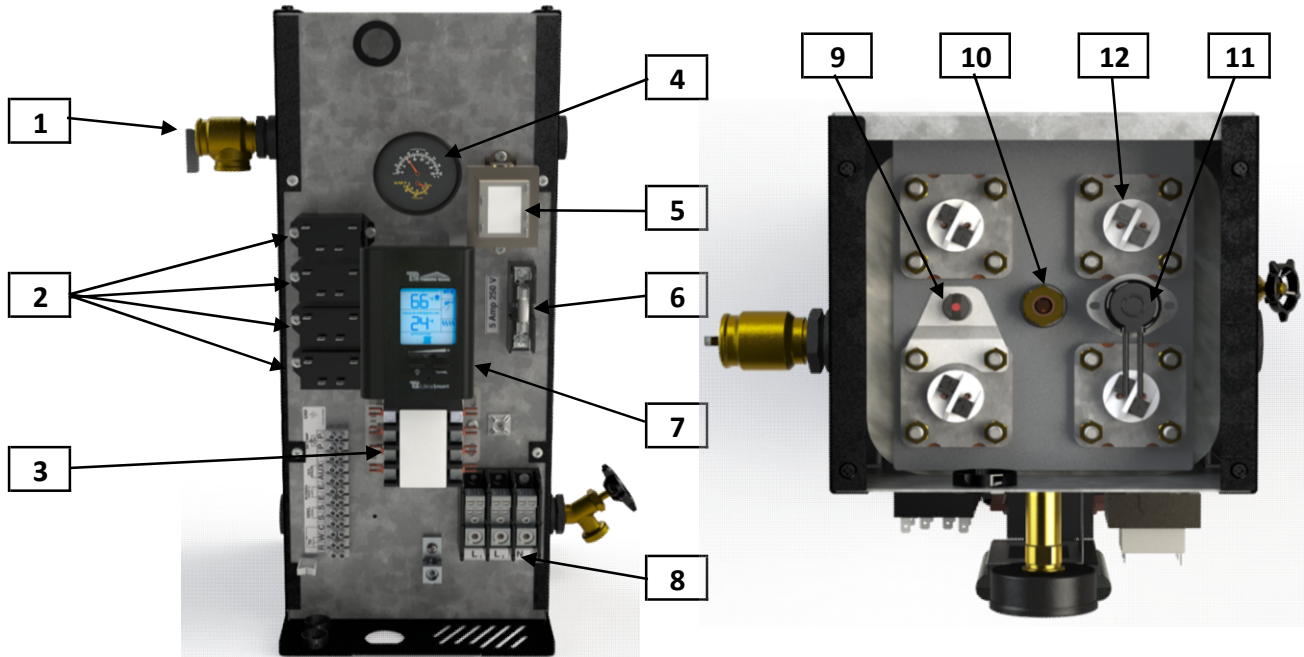

Item	Part number	Models	Description
1	ZMC200-SV30PSI1	All	Safety Valve 30 psi, 3/8"
2	ZEL100-24ACNO30	All	Power relay 24Vac
3	ZEL100-4P50A24	All	4 poles Contactor 24Vac
4	ZMC300-75P160CN	All	Temperature and Pressure Indicator
5	ZEL400-20842440	All	Transformer 208V-240V/24V 40VA
6	ZEL250-TDMIDJ5	All	Fuse
7	ZEL100-ULTRA	All	UltraSmart Controller
8	ZEL800-3P175600	All	Terminal Block 600V 3Poles 175A
9	ZEL200-DISC227	USA models	Surface High-Limit
10	ZEL100-SENSUNI	All	Boiler temperature sensor
	ZMC100-1/2X37/8	12kW to 24kW	Well 1/2 NPT x 3 7/8"
	ZMC100-3/8X37/8	12kW to 24kW ASME	Well 3/8 NPT x 3 7/8"
11	ZEL200-L6C732	All	High-Limit automatic reset Switch
	ZMC100-3/8NPT	All	Well 3/8 NPT x 7 1/2"
12	ZEL300-240V3KW	12kW ; 15kW	Heating element 3 kW 240V
	ZEL300-240V45KW	15kW ; 18kW	Heating element 4.5 kW 240V
	ZEL300-240V5KW	20kW	Heating element 5 kW 240V
	ZEL300-240V6KW	24kW	Heating element 6 kW 240V

BTH ULTRA 208/240V-1 ph.

Electric Boiler

Models from 27 to 36 kW : 208/240V (single phase)

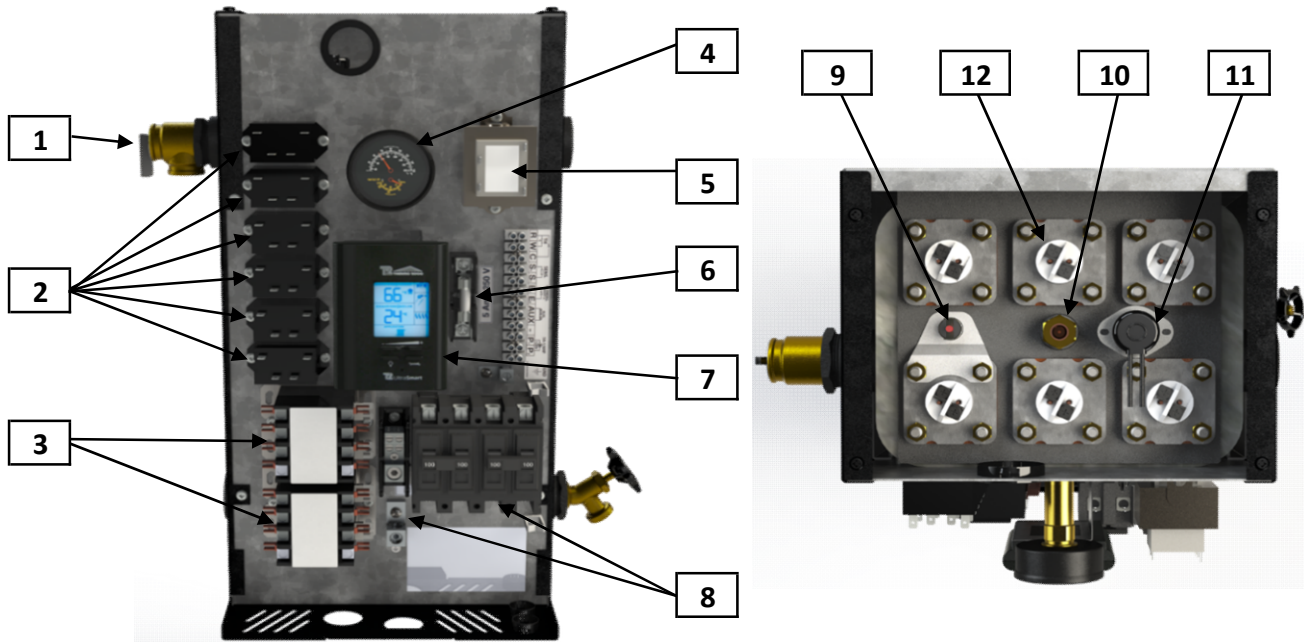

Item	Part number	Models	Description
1	ZMC200-SV30PSI1	All	Safety Valve 30 psi, 3/4"
2	ZEL100-24ACNO30	All	Power relay 24Vac
3	ZEL100-4P50A24	All	4 poles Contactor 24Vac
4	ZMC300-75P160CN	All	Temperature and Pressure Indicator
5	ZEL400-20842450	All	Transformer 208V-240V/24V 50VA
6	ZEL250-TDMIDJ5	All	Fuse
7	ZEL100-ULTRA	All	UltraSmart Controller
8	ZEL800-1P175600	33 kW ; 36 kW	Terminal Block 600V 1Poles 175A
	ZEL800-2P175600	27 kW ; 29 kW	Terminal Block 600V 2Poles 175A
	ZEL800-3P175600	27 kW ; 29 kW	Terminal Block 600V 3Poles 175A
	ZEL900-2P100A	33 kW ; 36 kW	Breaker
9	ZEL200-DISC227	33kW ; 36kW and USA models	Surface High-Limit
10	ZEL100-SENSUNI	All	Boiler temperature sensor
	ZMC100-1/2X37/8	27kW ; 29kW	Well 1/2 NPT x 3 7/8"
	ZMC100-3/8X37/8	27kW to 36kW ASME	Well 3/8 NPT x 3 7/8"
11	ZEL200-L6C732	All	High-Limit automatic reset Switch
	ZMC100-3/8NPT	All	Well 3/8 NPT x 7 1/2"
12	ZEL300-240V45KW	27kW ; 29kW	Heating element 4.5 kW 240V
	ZEL300-240V5KW	29kW ; 33kW	Heating element 5 kW 240V
	ZEL300-240V6KW	33kW ; 36kW	Heating element 6 kW 240V

BTH ULTRA 208/240V-3 ph.

Electric Boiler

Models from 7 to 36 kW : 208/240V (3 phases)

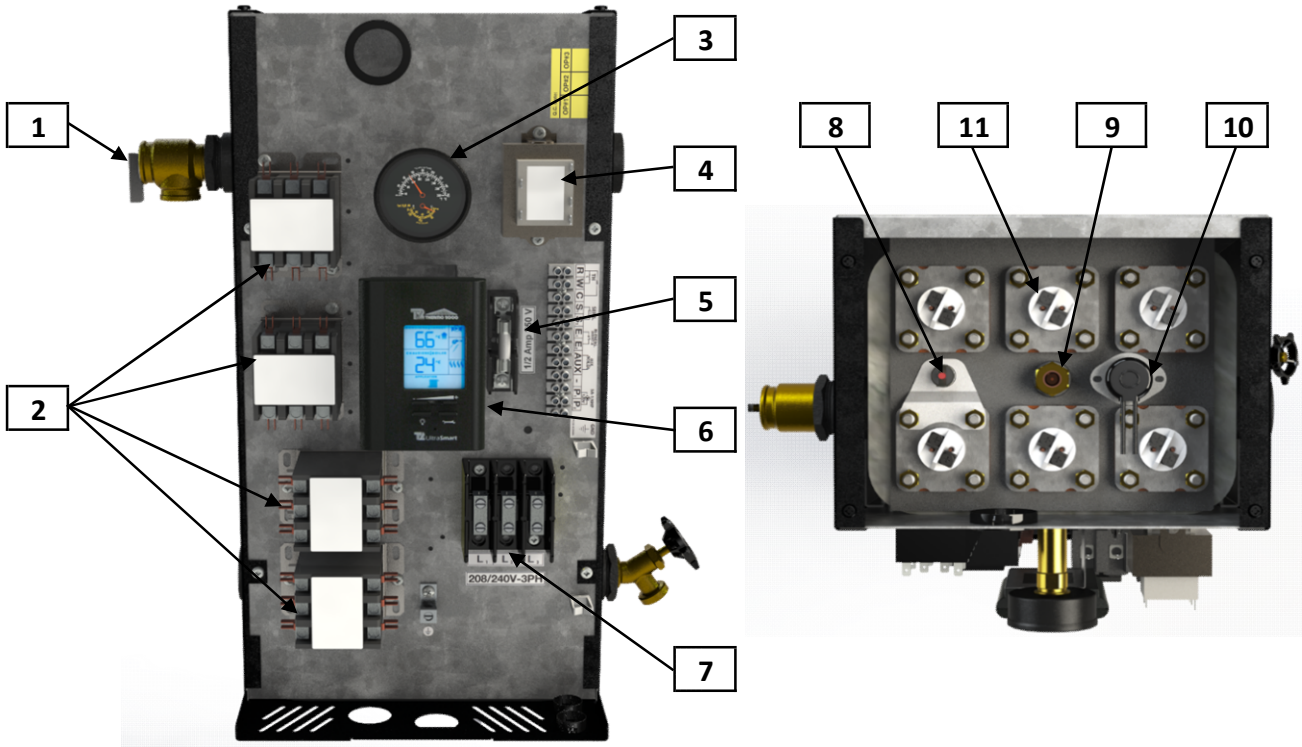

Item	Part number	Models	Description
1	ZMC200-SV30PSI1	All	Safety Valve 30 psi, 3/8"
2	ZEL100-3P50A24	All	3 poles Contactor 24Vac
3	ZMC300-75P160CN	All	Temperature and Pressure Indicator
4	ZEL400-20842450	All	Transformer 208V-240V/24V 50VA
5	ZEL250-FAMID1/2	All	Fuse 1/2 amp.
6	ZEL100-ULTRA	All	UltraSmart Controller
7	ZEL800-3P115600	All	Terminal Block 600V 3Poles 115A
8	ZEL200-DISC227	USA models	Surface High-Limit
9	ZEL100-SENSUNI	All	Boiler temperature sensor
	ZMC100-1/2X37/8	7kW to 30kW	Well 1/2 NPT x 3 7/8"
	ZMC100-3/8X37/8	7kW to 36kW ASME	Well 3/8 NPT x 3 7/8"
10	ZEL200-L6C732	All	High-Limit automatic reset Switch
	ZMC100-3/8NPT	All	Well 3/8 NPT x 1 1/2"
11	ZEL300-240V3KW	7kW ; 13kW ; 17kW	Heating element 3 kW 240V
	ZEL300-240V45KW	10kW ; 17kW ; 20kW	Heating element 4.5 kW 240V
	ZEL300-240V5KW	11kW ; 22kW ; 25kW	Heating element 5 kW 240V
	ZEL300-240V6KW	25kW ; 27kW	Heating element 6 kW 240V

BTH ULTRA 480/600V-3 ph.

Electric Boiler

Models from 7 to 36 kW : 480/600V (3 phases)

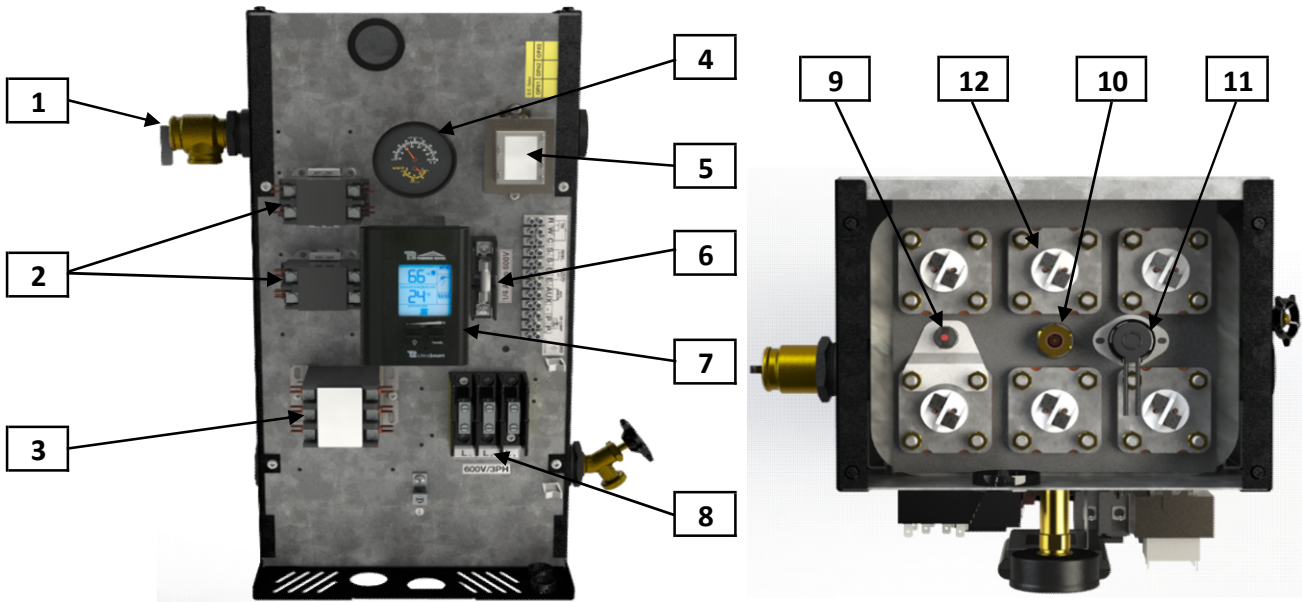

Item	Part number	Models	Description
1	ZMC200-SV30PSI1	All	Safety Valve 30 psi, 3/8"
2	ZEL100-2PC5024	All	2 poles Contactor 24Vac
3	ZEL100-3P50A24	All	3 poles Contactor 24Vac
4	ZMC300-75P160CN	All	Temperature and Pressure Indicator
5	ZEL400-48024-40	480V models	Transformer 480V/24V 40VA
	ZEL400-57524-50	600V models	Transformer 575/24V 50VA
6	ZEL250-TDCC1/4A	All	Time Delay Fuse 600V 1/4 Amp Class CC
7	ZEL100-ULTRA	All	UltraSmart Controller
8	ZEL800-3P115600	All	Terminal Block 600V 3Poles 115A
9	ZEL200-DISC227	33kW ; 36kW and USA models	Surface High-Limit
10	ZEL100-SENSUNI	All	Boiler temperature sensor
	ZMC100-1/2X37/8	7kW to 30kW	Well 1/2 NPT x 3 7/8"
	ZMC100-3/8X37/8	7kW to 36kW ASME	Well 3/8 NPT x 3 7/8"
11	ZEL200-L6C732	All	High-Limit automatic reset Switch
	ZMC100-3/8NPT	All	Well 3/8 NPT x 7 1/2"
12	ZEL300-277V5KW	15kW ; 30kW (480V)	Heating element 5 kW 277V
	ZEL300-277V6KW	18kW ; 36kW (480V)	Heating element 6 kW 277V
	ZEL300-347V3KW	9kW ; 18kW ; 22kW (600V)	Heating element 3 kW 347V
	ZEL300-347V45KW	13kW ; 22kW ; 27kW (600V)	Heating element 4.5 kW 347V
	ZEL300-347V5KW	30kW (600V)	Heating element 5 kW 347V
	ZEL300-347V6KW	36kW (600V)	Heating element 6 kW 347V

VOLTMAX 480/600V-3 ph.

Electric Boiler

Models from 30 to 180 kW : 480/600V (3 phases)

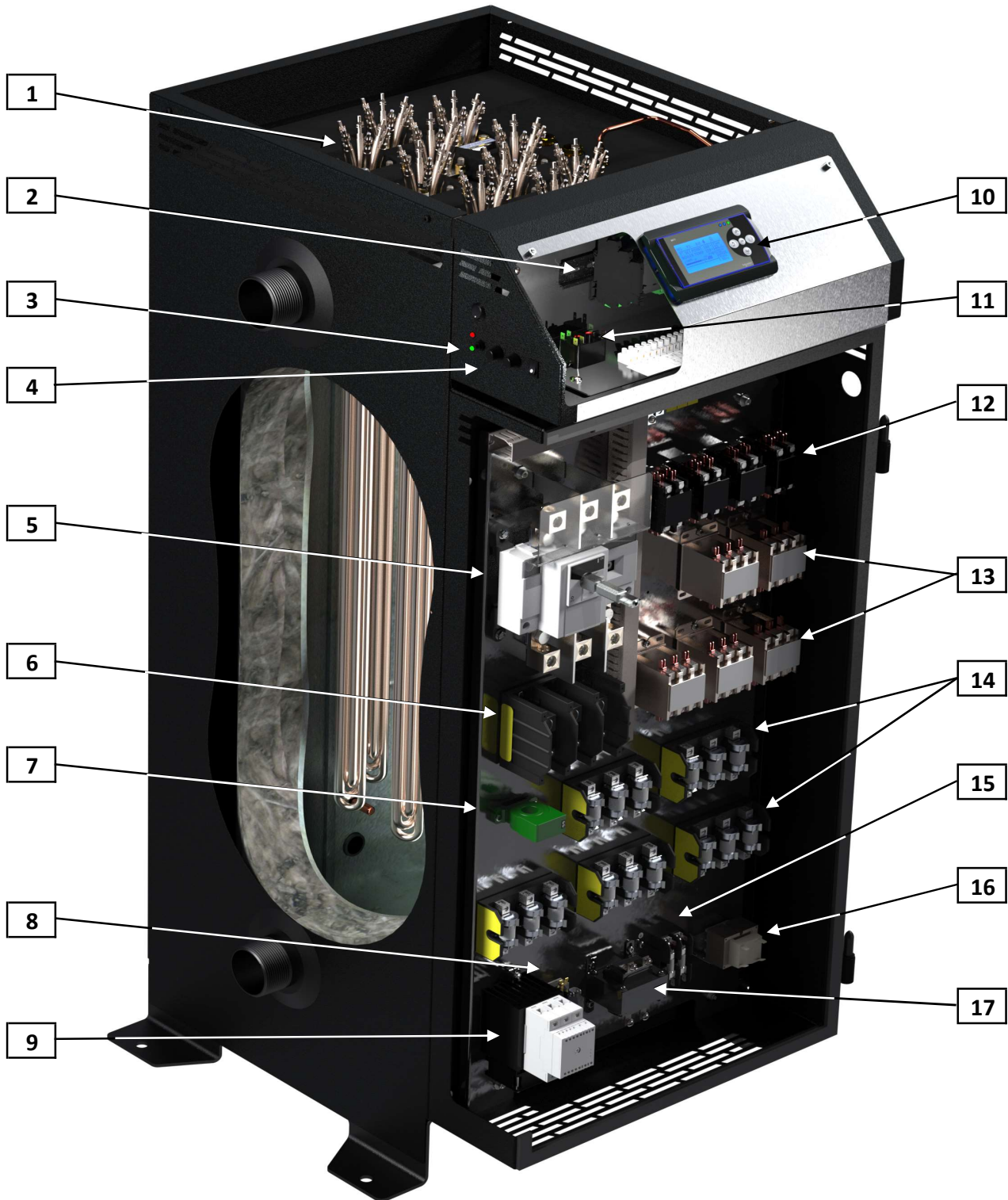

VOLTMAX 480/600V-3 ph.*Electric Boiler***Models from 30 to 180 kW : 480/600V (3 phases)**

Item	Part number	Models	Description
1	ZEL300-480V15WY	480V models	Heating element 15 kW 480V
	ZEL300-480V18WY	480V models	Heating element 18 kW 480V
	ZEL300-600V15WY	600V models	Heating element 15 kW 600V
	ZEL300-600V18WY	600V models	Heating element 18 kW 600V
2	ZEL100-SEXP171	All	VOLTMAX Expansion module
3	ZEL200-NIV120V	Option and 120kW to 180kW	Low water cut-off
4	ZEL250-TEMP1/2A	All	Fuse
	ZEL250-TEMP3/4A	75kW to 144kW	Fuse
	ZEL250-TEMP1A	150kW to 180kW	Fuse
5	ZEL550-SWIT60A	Option	Main disconnect switch 60A without fuse
	ZEL550-SWIF60A	Option	Main disconnect switch 60A with fuse
	ZEL550-SWIT100A	Option	Main disconnect switch 100A without fuse
	ZEL550-SWIF100A	Option	Main disconnect switch 100A with fuse
	ZEL550-SWIT200A	Option	Main disconnect switch 200A without fuse
	ZEL550-SWIF200A	Option	Main disconnect switch 200A with fuse
6	ZEL800-3P175600	30kW to 144kW	Terminal Block 600V 3Poles 175A
	ZEL800-3P310600	150kW to 180kW	Terminal Block 600V 3Poles 310A
7	ZEL450-CSENS200	SCR models	Current transducer 200A
8	ZEL200-SEQ120NO	120kW to 180kW	Simple sequencer
9	ZEL100-SCR30APH	SCR models 30kW to 90kW	Solid state SCR relay 30A/600V/3ph
	ZEL100-SCR65APH	SCR models 99kW to 180kW	Solid state SCR relay 65A/600V/3ph
10	ZEL100-SDISM171	All	VOLTMAX digital controller
11	ZEL100-RELDPST	All	Relay DPST- 1NO/1NC 120Vac
12	ZEL100-2PC50120	All	2 poles Contactor 120Vac
13	ZEL100-3P50A120	All	3 poles Contactor 120Vac
14	ZEL250-FAT25A	45 to 54kW and 75 to 90kW	Fast Acting Fuse 600V 25 Amp Class T
	ZEL250-FAT50A	All	Fast Acting Fuse 600V 50 Amp Class T
15	ZEL250-TDCC2/10	30kW to 72kW	Time Delay Fuse 600V 2/10 Amp Class CC
	ZEL250-TDCC1/4A	75kW to 108kW	Time Delay Fuse 600V 1/4 Amp Class CC
	ZEL250-TDCC1/2A	120kW to 180kW	Time Delay Fuse 600V 1/2 Amp Class CC
16	ZEL400-120V40VA	All	Transformer 120V/24V 40VA
17	ZEL400-480100VA	30kW to 180kW (480V)	Transformer 480V/120V 100VA
	ZEL400-600V50VA	30kW to 54kW (600V)	Transformer 600V/120V 50VA
	ZEL400-600100VA	60kW to 180kW (600V)	Transformer 600V/120V 100VA

VOLTMAX 480/600V-3 ph.

Electric Boiler

Models from 192 to 408 kW : 480/600V (3 phases)

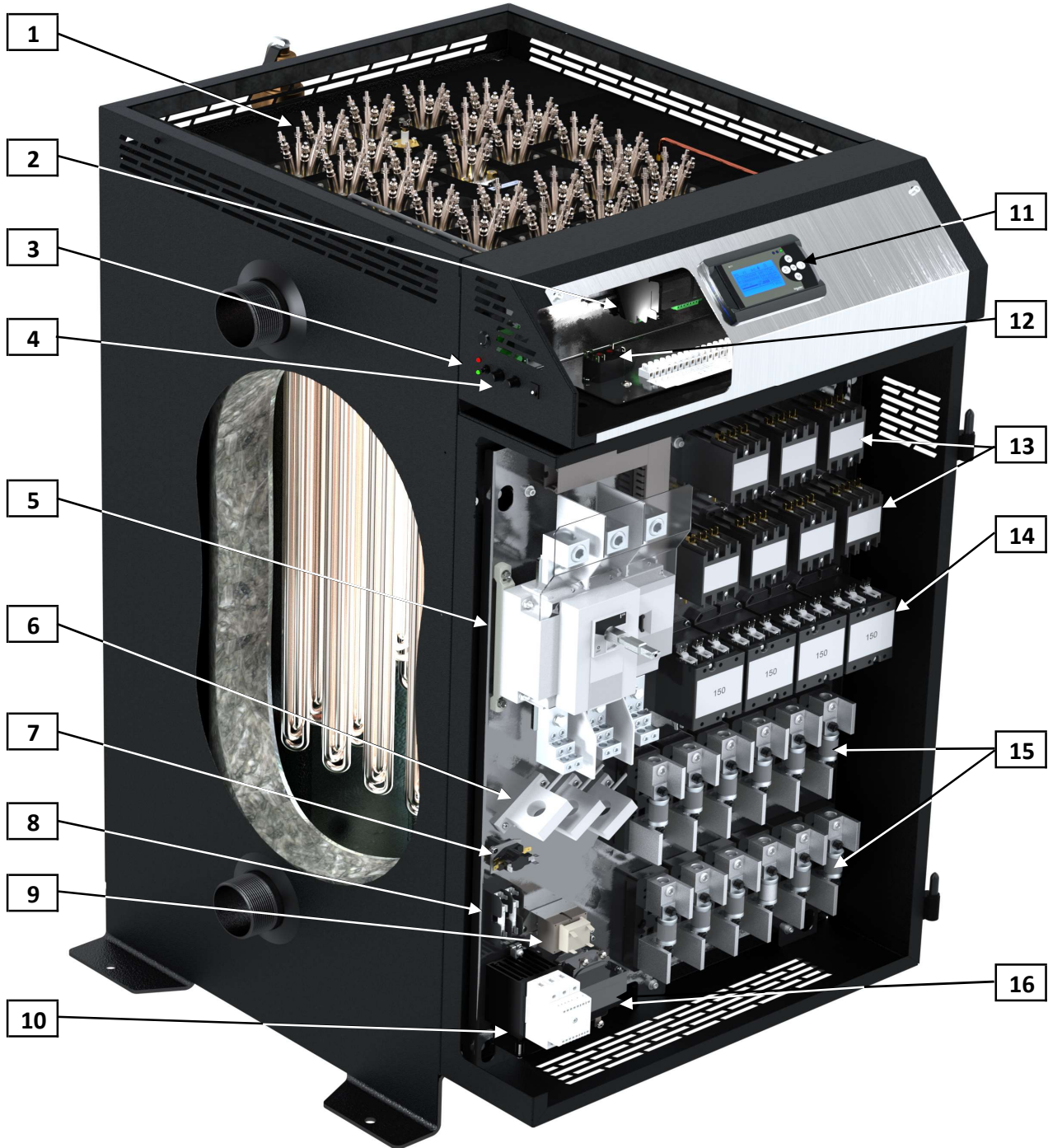

VOLTMAX 480/600V-3 ph.*Electric Boiler***Models from 192 to 408 kW : 480/600V (3 phases)**

Item	Part number	Models	Description
1	ZEL300-480V15WY	480V models	Heating element 15 kW 480V
	ZEL300-480V18WY	480V models	Heating element 18 kW 480V
	ZEL300-600V15WY	600V models	Heating element 15 kW 600V
	ZEL300-600V18WY	600V models	Heating element 18 kW 600V
2	ZEL100-SEXP171	All	VOLTMAX Expansion module
3	ZEL200-NIV120V	All	Low water cut-off
4	ZEL250-TEMP3/4A	All	Fuse
	ZEL250-TEMP1A	192kW to 204kW	Fuse
	ZEL250-TEMP1.5A	225kW to 306kW and 324kW	Fuse
	ZEL250-TEMP2A	315kW and 336kW to 408kW	Fuse
5	ZEL800-3P310600	192kW (480V) 192kW to 255kW (600V)	Terminal Block 600V 3Poles 310A
	ZEL800-3P380600	204kW to 255kW (480V) 270kW to 324kW (600V)	Terminal Block 600V 3Poles 380A
	ZEL800-3P420600	288kW (480V) 336kW to 357kW (600V)	Terminal Block 600V 3Poles 420A
	ZEL800-3P570600	306kW to 384kW (480V) 378kW to 408kW (600V)	Terminal Block 600V 3Poles 570A
	ZEL800-3P760600	408kW (480V)	Terminal Block 600V 3Poles 760A
	ZEL550-SWIT400A	Option	Main disconnect switch 400A without fuse
	ZEL550-SWIF400A	Option	Main disconnect switch 400A with fuse
6	ZEL450-CSENS200	All	Current transducer 200A
7	ZEL200-SEQ120NO	225kW to 408kW	Simple sequencer
8	ZEL250-TDCC1/2A	192kW to 204kW(480V) 192kW to 270kW (600V)	Time Delay Fuse 600V 1/2 Amp Class CC
	ZEL250-TDCC6/10	225kW to 255kW(480V) 288kW to 324kW (600V)	Time Delay Fuse 600V 6/10 Amp Class CC
	ZEL250-TDCC3/4A	288kW to 357kW(480V) 315kW to 408kW (600V)	Time Delay Fuse 600V 3/4 Amp Class CC
	ZEL250-TDCC1A	384kW and 408kW (480V)	Time Delay Fuse 600V 1 Amp Class CC
9	ZEL400-120V40VA	All	Transformer 120V/24V 40VA
10	ZEL100-SCR65APH	All	Solid state SCR relay 65A/600V/3ph
11	ZEL100-SDISM171	All	VOLTMAX digital controller
12	ZEL100-RELDPST	All	Relay DPST- 1NO/1NC 120Vac
13	ZEL100-3P75A120	All	3 poles Contactor 120Vac
14	ZEL100-3P150A120	All	3 poles Contactor 120Vac

VOLTMAX 480/600V-3 ph.*Electric Boiler***Models from 192 to 408 kW : 480/600V (3 phases)**

Item	Part number	Models	Description
15	ZEL250-FAT60A	225kW to 270kW and 315kW to 378kW (600V)	Fast Acting Fuse 600V 60 Amp Class T
	ZEL250-FAT80A	225kW to 255kW et 315kW to 357kW (480V)	Fast Acting Fuse 600V 80 Amp Class T
	ZEL250-FAT125A	192kW to 408kW (600V)	Fast Acting Fuse 600V 125 Amp Class T
	ZEL250-FAT150A	192kW to 408kW (480V)	Fast Acting Fuse 600V 150 Amp Class T
16	ZEL400-480200VA	480V models	Transformer 480V/120V 200VA
	ZEL400-600200VA	600V models	Transformer 600V/120V 200VA

Power capacity from 4.5 kW to 29 kW : 208/240V (single phase)

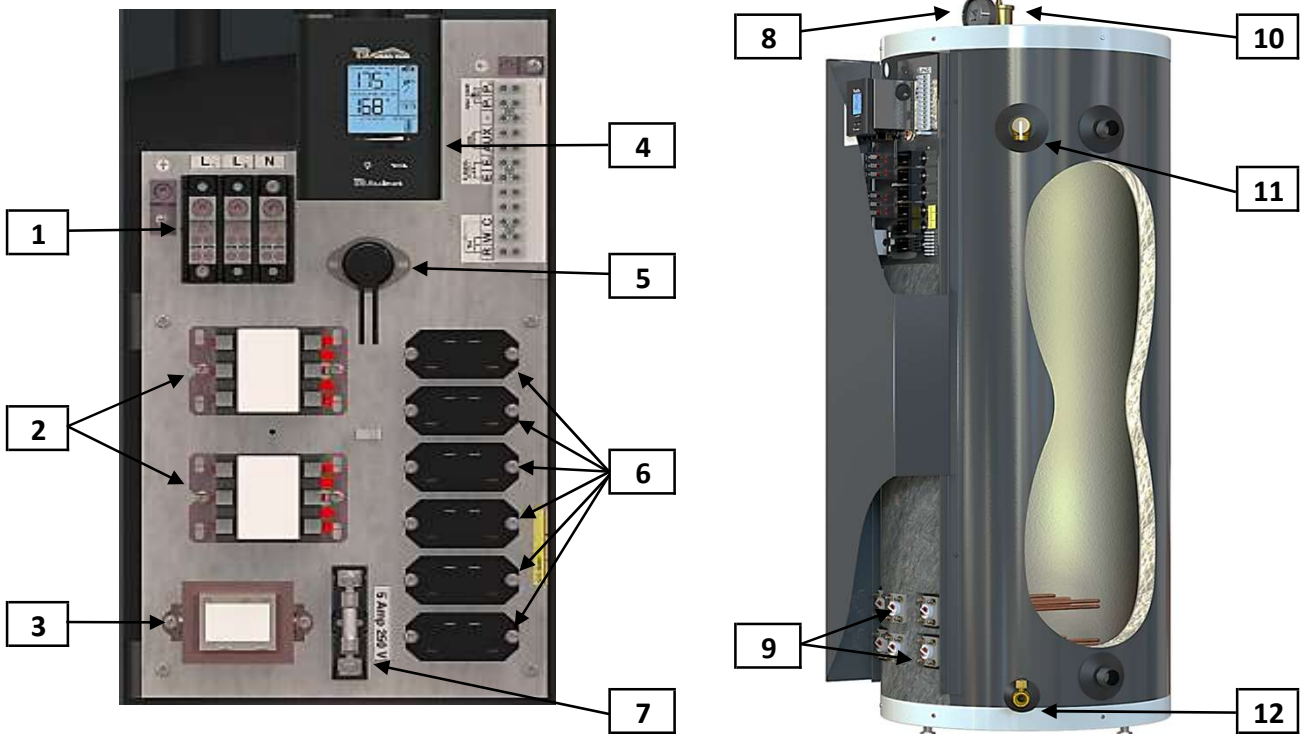

Item	Part number	Models	Description
1	ZEL800-3P115600	3kW to 12kW	Terminal Block 600V 3Poles 115A
	ZEL800-3P175600	15kW to 29kW	Terminal Block 600V 3Poles 175A
2	ZEL100-2PC5024	4.5kW ; 7.5kW ; 9kW	2 poles Contactor 24Vac
	ZEL100-4P50A24	12kW to 24kW	4 poles Contactor 24Vac
	ZEL100-3P50A24	27kW to 29kW	3 poles Contactor 24Vac
3	ZEL400-20842440	All	Transformer 208V-240V/24V 40VA
4	ZEL100-ULTRA	All	UltraSmart Controller
5	ZEL200-HL195F	All	High-Limit automatic reset Switch
6	ZEL100-24ACNO30	All	Power relay 24Vac
7	ZEL250-TDMIDJ5	All	Fuse
8	ZMC300-120PT4PO	All	Temperature and Pressure Indicator
9	ZEL300-240V3KW	7.5kW ; 15kW	Heating element 3 kW 240V
	ZEL300-240V45KW	4.5 ; 7.5 ; 15 ; 27 ; 29kW	Heating element 4.5 kW 240V
	ZEL300-240V5KW	20kW ; 29kW	Heating element 5 kW 240V
	ZEL300-240V6KW	12kW ; 24kW	Heating element 6 kW 240V
10	ZMC600-AV1/2	All	Air vent 1/2"
	ZMC600-CV1/2	All	Check valve
11	ZMC200-SV30PSI2	All	Safety Valve 30 psi, 3/4"
12	ZMC200-BVP34NPT	All	Drain valve 3/4"

COMBOMAX ULTRA

Combined electric boiler and
instantaneous water heater

Power capacity from 4.5 kW to 29 kW : 208/240V (single phase)

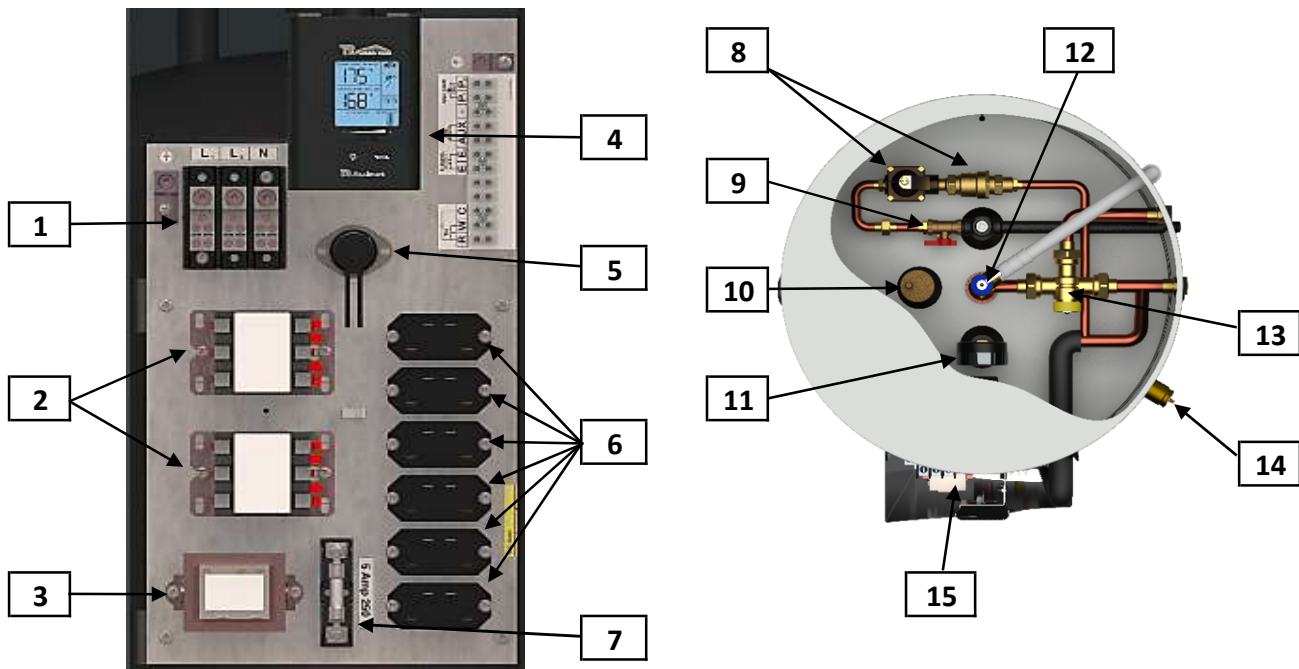

Item	Part number	Models	Description
1	ZEL800-3P115600	3kW to 12kW	Terminal Block 600V 3Poles 115A
	ZEL800-3P175600	15kW to 29kW	Terminal Block 600V 3Poles 175A
2	ZEL100-2PC5024	4.5kW ; 7.5kW ; 9kW	2 poles Contactor 24Vac
	ZEL100-4P50A24	12kW to 24kW	4 poles Contactor 24Vac
	ZEL100-3P50A24	27kW to 29kW	3 poles Contactor 24Vac
3	ZEL400-20842440	All	Transformer 208V-240V/24V 40VA
4	ZEL100-ULTRA	All	UltraSmart Controller
5	ZEL200-HL195F	All	High-Limit automatic reset Switch
6	ZEL100-24ACNO30	All	Power relay 24Vac
7	ZEL250-TDMIDJ5	All	Fuse
8	ZMC950-PRES&CHK	All	Pressure reducer and check valve
9	ZMC200-BVP12NPT	All	Ball valve ½"
10	ZMC600-AV1/2	All	Air vent ½"
	ZMC600-CV1/2	All	Check valve
11	ZMC300-120PT4PO	All	Temperature and Pressure Indicator
12	ZMC200-SVTP125	All	Safety Relief Valve 125 psi, ¾"
13	ZMC200-MIX34SWT	All	Mixing Valve 100F-145F
14	ZMC200-SV30PSI2	All	Safety Valve 30 psi, ¾"
15	ZEL300-240V3KW	7.5kW ; 15kW	Heating element 3 kW 240V
	ZEL300-240V45KW	4.5 ; 7.5 ; 15 ; 27 ; 29kW	Heating element 4.5 kW 240V
	ZEL300-240V5KW	20kW ; 29kW	Heating element 5 kW 240V
	ZEL300-240V6KW	12kW ; 24kW	Heating element 6 kW 240V

COMBOMAX 109 COMMERCIAL

Combined electric boiler and
instantaneous water heater

Power capacity from 6 kW to 30 kW : 240V (single phase)

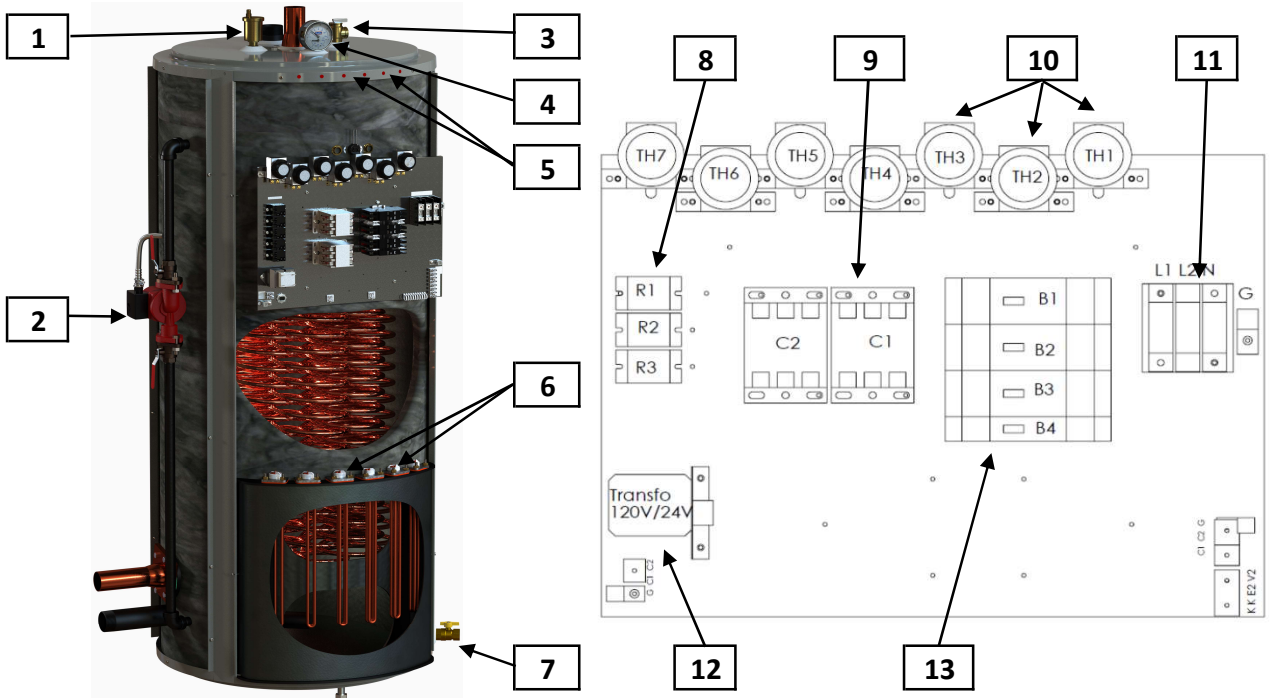

Item	Part number	Models	Description
1	ZMC600-AV1/2	All	Air vent ½"
	ZMC600-CV1/2	All	Check valve
2	ZMC960-UPS15RU	All	Recirculating pump
3	ZMC200-SV30PSI2	All	Safety Valve 30 psi, ¾"
4	ZMC300-120PT4PO	All	Temperature and Pressure Indicator
5	ZEL150-240VRED	All	Indicating lamp
6	ZEL300-240V3KW	6kW ; 8kW ; 12kW ; 15kW	Heating element 3 kW 240V
	ZEL300-240V45KW	15kW ; 18kW ; 27kW	Heating element 4.5 kW 240V
	ZEL300-240V5KW	8kW ; 10kW ; 20kW ; 30kW	Heating element 5 kW 240V
	ZEL300-240V6KW	24kW	Heating element 6 kW 240V
7	ZMC200-BVP34NPT	All	Drain valve ¾"
8	ZEL100-24ACSPST	All	Power relay 24Vac
9	ZEL100-3P50A120	All	3 poles Contactor 120Vac
10	ZEL200-G111781	All	Temperature control
11	ZEL800-3P175600	All	Terminal Block 600V 3Poles 175A
12	ZEL400-120V40VA	All	Transformer 120V/24V 40VA
13	ZEL250-TDCC6/10	6kW to 24kW	Time Delay Fuse 600V 6/10 Amp Class CC
	ZEL250-TDCC15A	6kW to 24kW	Time Delay Fuse 600V 15 Amp Class CC
	ZEL900-1P15A	27kW to 30kW	Braker 1 pole 15A
	ZEL900-2P60A	27kW to 30kW	Braker 2 poles 60A

COMBOMAX 109 COMMERCIAL

Combined electric boiler and
instantaneous water heater

Power capacity from 9 kW to 30 kW : 600V (3 phases)

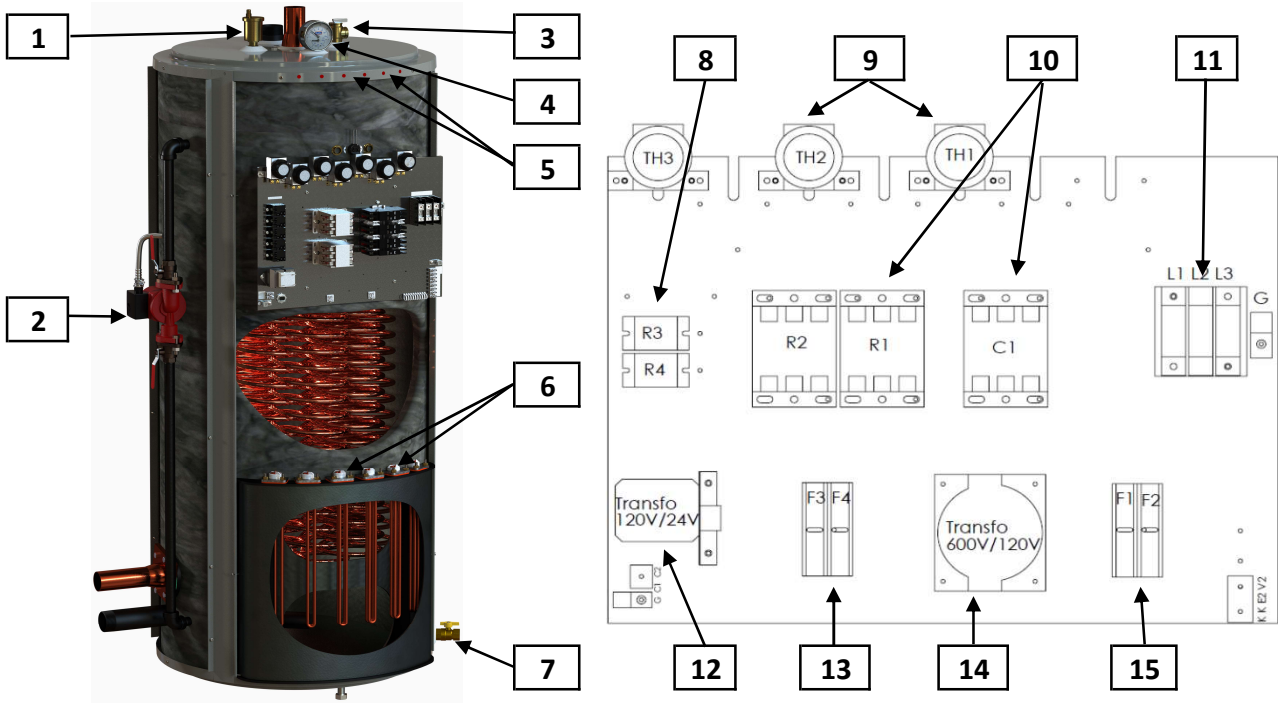

Item	Part number	Models	Description
1	ZMC600-AV1/2	All	Air vent ½"
	ZMC600-CV1/2	All	Check valve
2	ZMC960-UPS15RU	All	Recirculating pump
3	ZMC200-SV30PSI2	All	Safety Valve 30 psi, ¾"
4	ZMC300-120PT4PO	All	Temperature and Pressure Indicator
5	ZEL150-120VAMB	All	Indicating lamp
6	ZEL300-347V3KW	9kW ; 18kW ; 22kW	Heating element 3 kW 347V
	ZEL300-347V45KW	13kW ; 22kW ; 27kW	Heating element 4.5 kW 347V
	ZEL300-347V5KW	30kW	Heating element 5 kW 347V
7	ZMC200-BVP34NPT	All	Drain valve ¾"
8	ZEL100-24ACSPST	All	Power relay 24Vac
9	ZEL200-G111781	All	Temperature control
10	ZEL100-3P50A120	All	3 poles Contactor 120Vac
11	ZEL800-3P115600	All	Terminal Block 600V 3Poles 115A
12	ZEL400-120V40VA	All	Transformer 120V/24V 40VA
13	ZEL250-TDCC2A	All	Time Delay Fuse 600V 1 Amp Class CC
14	ZEL400-600100VA	9kW to 22kW	Transformer 600V/120V 100VA
	ZEL400-600200VA	27kW to 30kW	Transformer 600V/120V 200VA
15	ZEL250-FAMID1/2	All	Fuse ½ amp.

TurboMax

Instantaneous Indirect Water Heater

Models 23, 24, 33, 34, 43, 44, 45, 65, 65A, 109 and 109A



Item	Part number	Models	Description
1	ZMC600-AV1/2	All	Air vent ½"
	ZMC600-CV1/2	All	Check valve
2	ZMC300-120PT4PO	24, 44, 45, 65, 109	Temperature and Pressure Indicator
	ZMC300-120PT8PO	65A, 109A	Temperature and Pressure Indicator
3	ZMC200-SV30PSI2	23, 33, 34, 43, 44, 45, 65	Safety Valve 30 psi, ¾"
	ZMC200-SV50PSI2	65A	Safety Valve 50 psi, ¾"
	ZMC200-SV50PSI3	109, 109A	Safety Valve 50 psi, ¾"
4	ZEL200-AQU_AJUS	All	Aquastat
5	ZMC200-BVP34NPT	All	Drain valve ¾"

DoubleMax

Instantaneous indirect double-wall water heater

Models 50-4, 80-5 and 120-9



Item	Part number	Models	Description
1	ZMC600-AV1/2	All	Air vent 1/2"
	ZMC600-CV1/2	All	Check valve
2	ZMC200-SV30PSI2	50-4 ; 80-5	Safety Valve 30 psi, 3/4"
	ZMC200-SV50PSI3	120-9	Safety Valve 50 psi, 3/4"
3	ZMC300-200P160C	All	Temperature and Pressure Indicator
4	ZMC100-1/2X53/8	All	Well 1/2 NPT x 5 3/8"
	ZEL200-AQAJUSDM	All	Aquastat
5	ZMC200-BVP34NPT	All	Drain valve 3/4"

BuffMax

Buffer tank
Storage tank
Hydraulic separator

Models 30, 50, 80, 120, 120A, 175A, 200A

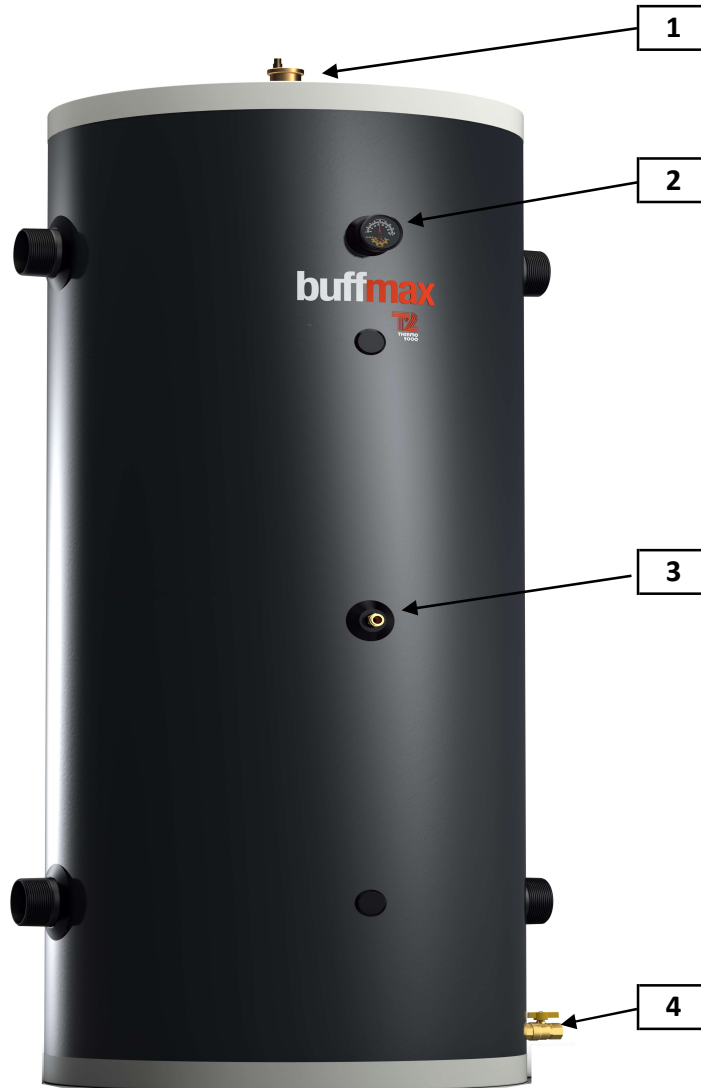

Item	Part number	Models	Description
1	ZMC600-AV1/2	All	Air vent 1/2"
	ZMC600-CV1/2	All	Check valve
2	ZMC300-200P160C	All	Temperature and Pressure Indicator
3	ZMC100-1/2X53/8	All	Well 1/2 NPT x 5 3/8"
4	ZMC200-BVP34NPT	All	Drain valve 3/4"

Ventum

Hydronic fancoil

Models 40 and 60

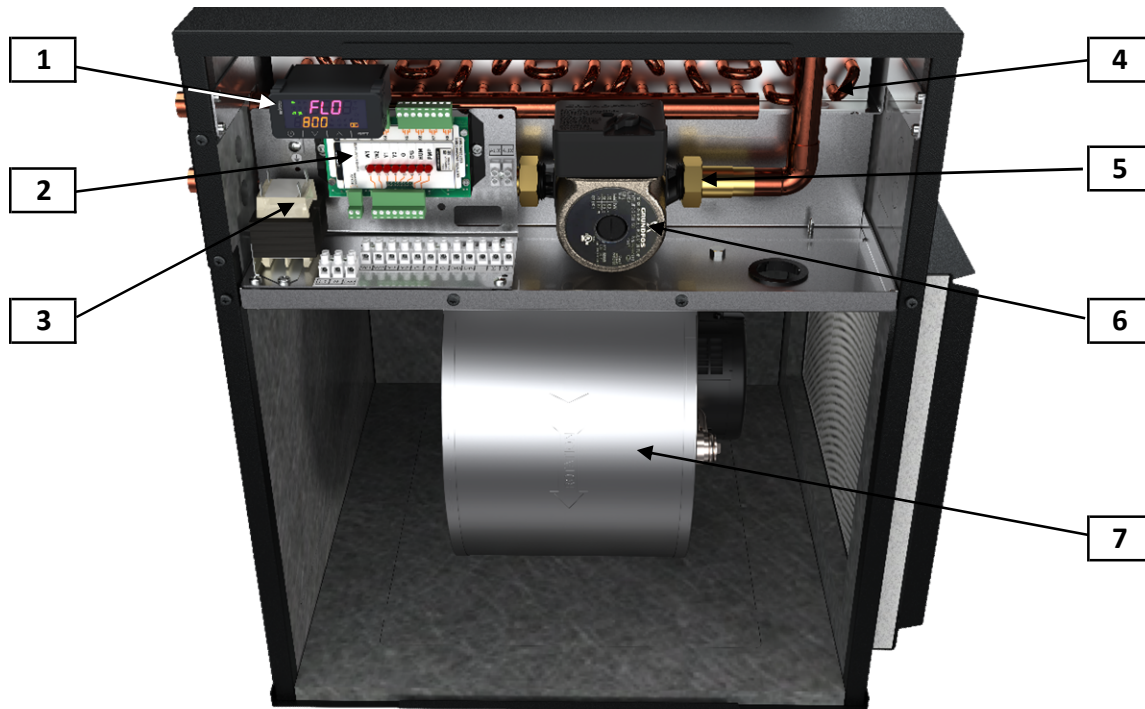

Item	Part number	Models	Description
1	ZEL100-CPRO3	All	C-PRO 3 nano evco controller
2	ZEL100-MRB824V	All	MRB-8-24VAC relay board
3	ZEL400-120V40VA	All	Transformer 120V/24V 40VA
4	ZMC250-RAD40	40	40MBH coil
	ZMC250-RAD60	60	60MBH coil
5	ZMC200-UPS15RU	All	3/4 sweat fitting with check valve for RU
6	ZMC960-UPS15RU	All	Recirculating pump
7	ZMC700-9X6EON	40	9x6 1/2HP Eon ferrite blower
	ZMC700-10X10EO	60	10 x 10 3/4 hp eon ferrite blower

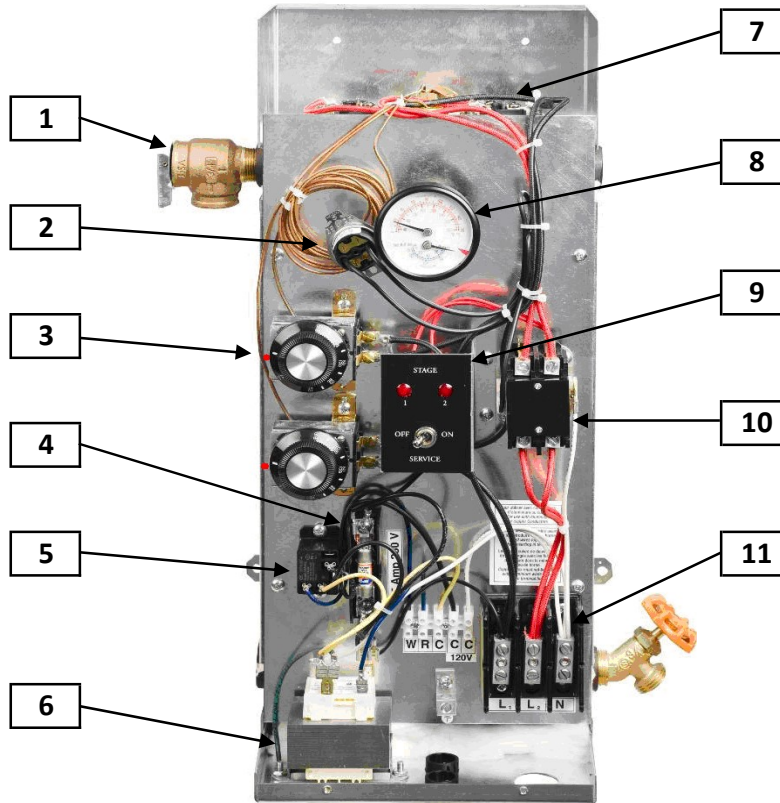
MINI BTH (2014 models and less)**Electric Boiler****Models from 3 kW to 12 kW : 208/240V (single phase)**

Item	Part number	Models	Description
1	ZMC200-SV30PSI1	All	Safety Valve 30 psi, ¼"
2	ZEL200-L6C732	All	High-Limit automatic reset Switch
3	ZEL200-G1111781	All	Temperature control
4	ZEL250-TDCC15A	All	Time Delay Fuse 600V 15 Amp Class CC
5	ZEL100-24ACSPST	All	Power relay 24Vac
6	ZEL400-120V40VA	All	Transformer 120V/24V 40VA
7	ZEL300-240V3KW	3 ; 7.5kW	Heating element 3 kW 240V
	ZEL300-240V45KW	4.5 ; 7.5 ; 9kW	Heating element 4.5 kW 240V
	ZEL300-240V6KW	12kW	Heating element 6 kW 240V
8	ZMC300-75P160C	All	Temperature and Pressure Indicator
9	ZEL150-240VRED	All	Indicating lamp
10	ZEL100-2PC50120	3 ; 4.5 ; 7.5 ; 9kW	2 poles Contactor 120Vac
	ZEL100-4P50A120	12kW	4 poles Contactor 120Vac
11	ZEL800-3P115600	All	Terminal Block 600V 3Poles 115A

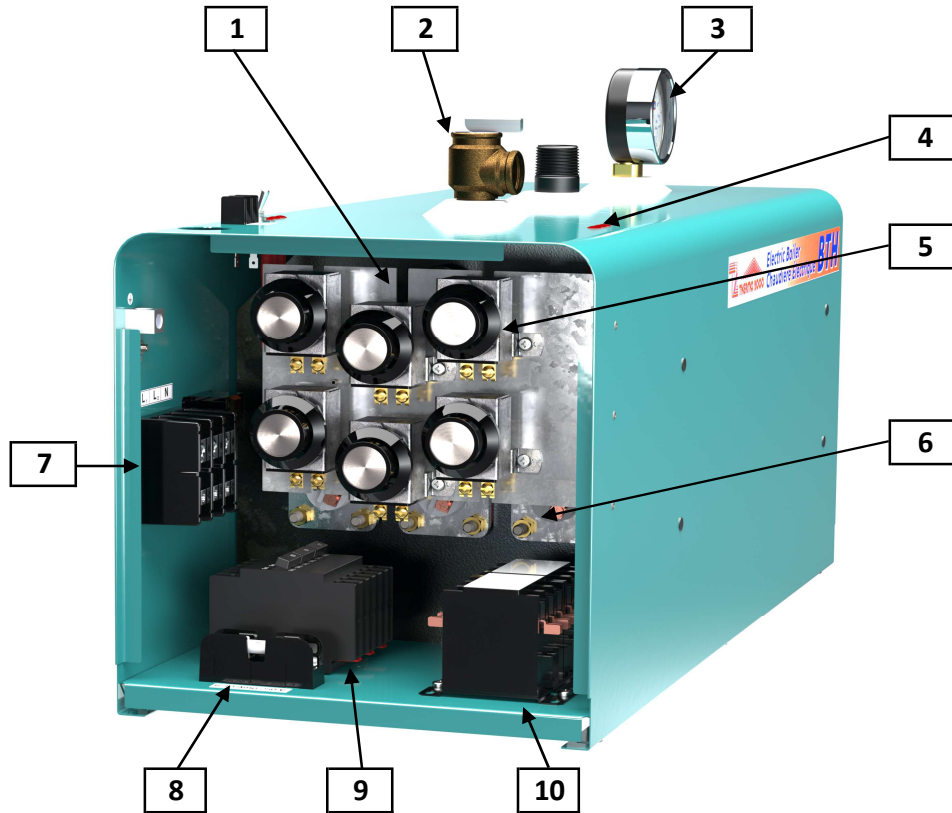
BTH**Electric Boiler****Models from 8 kW to 33 kW : 240V (single phase)**

Item	Part number	Models	Description
1	ZEL200-L6C732	All	High-Limit automatic reset Switch
2	ZMC200-SV30PSI1	All	Safety Valve 30 psi, 3/8"
3	ZMC300-75P160CN	All	Temperature and Pressure Indicator
4	ZEL150-240VRED	All	Indicating lamp
5	ZEL200-G111781	All	Temperature control
6	ZEL300-240V3KW	8kW ; 12kW ; 15kW	Heating element 3 kW 240V
	ZEL300-240V45KW	15kW ; 18kW ; 27kW	Heating element 4.5 kW 240V
	ZEL300-240V5KW	8 ; 10 ; 20kW ; 30kW ; 33kW	Heating element 5 kW 240V
	ZEL300-240V6KW	24kW ; 33kW	Heating element 6 kW 240V
7	ZEL800-3P175600	All	Terminal Block 600V 3Poles 175A
8	ZEL250-TDCC6/10	All	Time Delay Fuse 600V 6/10 Amp Class CC
9	ZEL900-2P60A	30kW ; 33kW	Braker 2 poles 60A
10	ZEL100-3P50A120	8kW ; 10 kW ; 27kW to 33kW	3 poles Contactor 120Vac
	ZEL100-4P50A120	12kW to 24kW	4 poles Contactor 120Vac
	ZEL100-3P50A240	2006 models and less	3 poles Contactor 240Vac
	ZEL100-4P50A240	2006 models and less	4 poles Contactor 240Vac

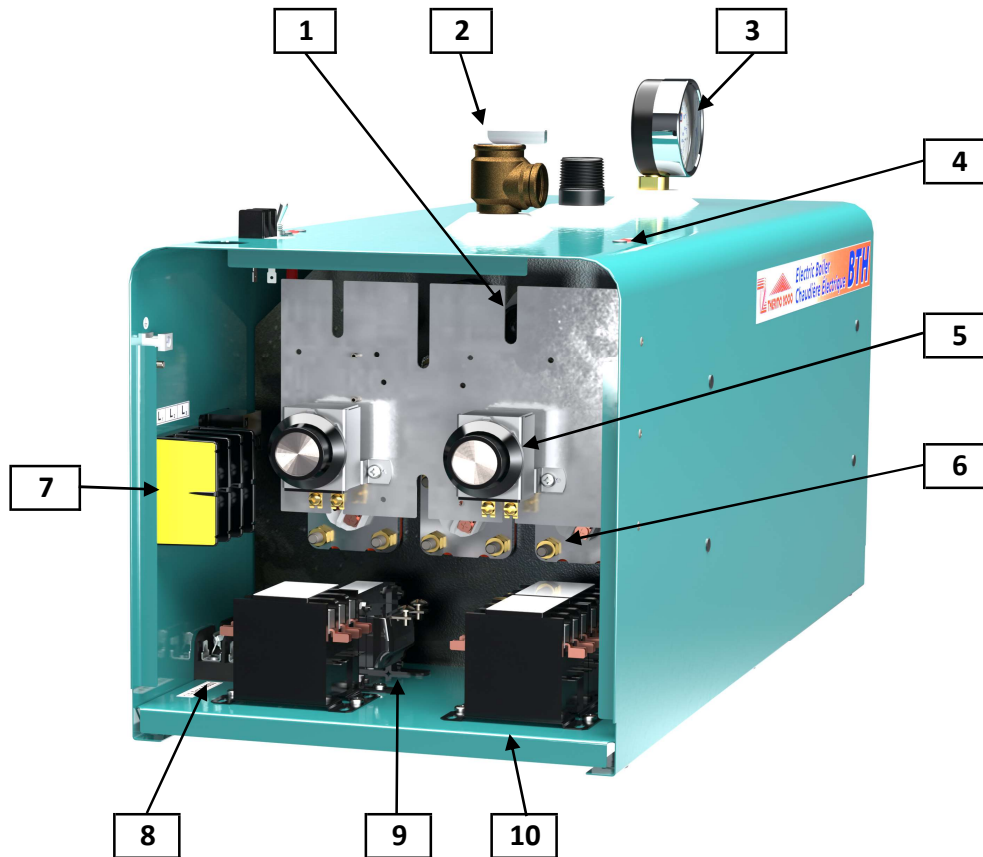
BTH**Electric Boiler****Models from 9 kW to 36 kW : 600V (3 phases)**

Item	Part number	Models	Description
1	ZEL200-L6C732	All	High-Limit automatic reset Switch
2	ZMC200-SV30PSI1	All	Safety Valve 30 psi, 3/4"
3	ZMC300-75P160CN	All	Temperature and Pressure Indicator
4	ZEL150-120VAMB	All	Indicating lamp
5	ZEL200-G111781	All	Temperature control
6	ZEL300-347V3KW	9kW ; 18kW ; 22kW	Heating element 3 kW 347V
	ZEL300-347V45KW	13kW ; 27kW	Heating element 4.5 kW 347V
	ZEL300-347V5KW	30kW	Heating element 5 kW 347V
	ZEL300-347V6KW	36kW	Heating element 6 kW 347V
7	ZEL800-3P115600	All	Terminal Block 600V 3Poles 115A
8	ZEL250-TDCC1/4A	All	Time Delay Fuse 600V 1/4 Amp Class CC
9	ZEL400-600100VA	All	Transformer 600V/120V 100VA
10	ZEL100-3P50A120	All	3 poles Contactor 120Vac
	ZEL100-3P50A240	2006 models and less	3 poles Contactor 240Vac

BTH ULTRA (2014 models and less)

Electric Boiler

Models from 6 kW to 33 kW : 240V (single phase)

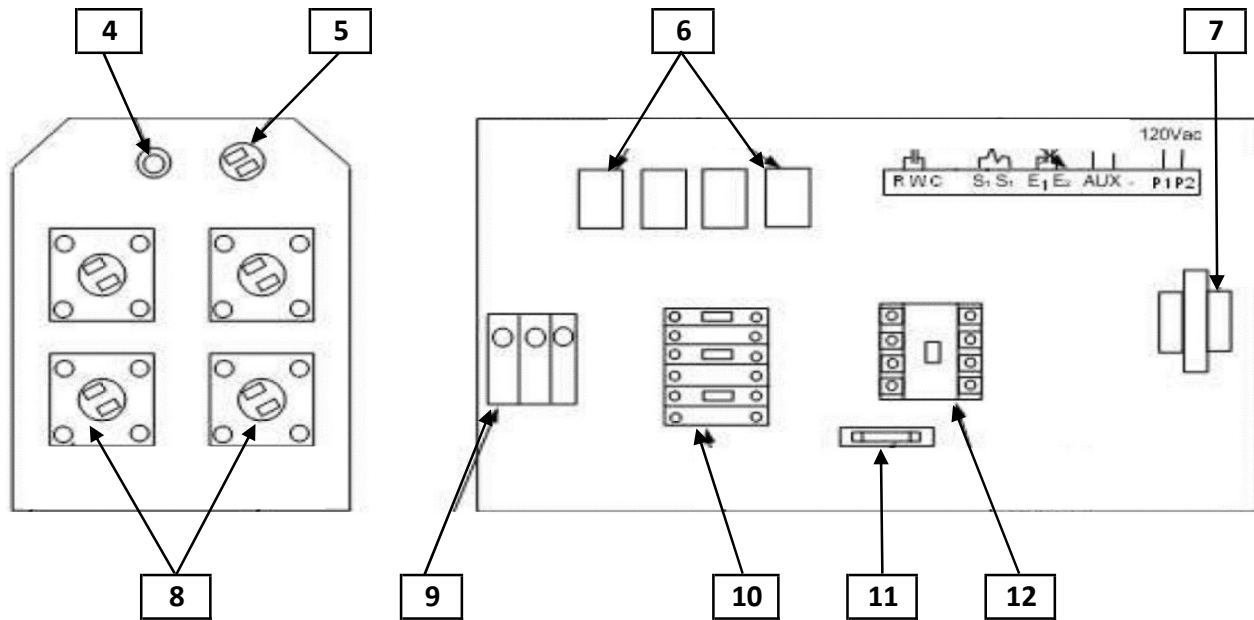
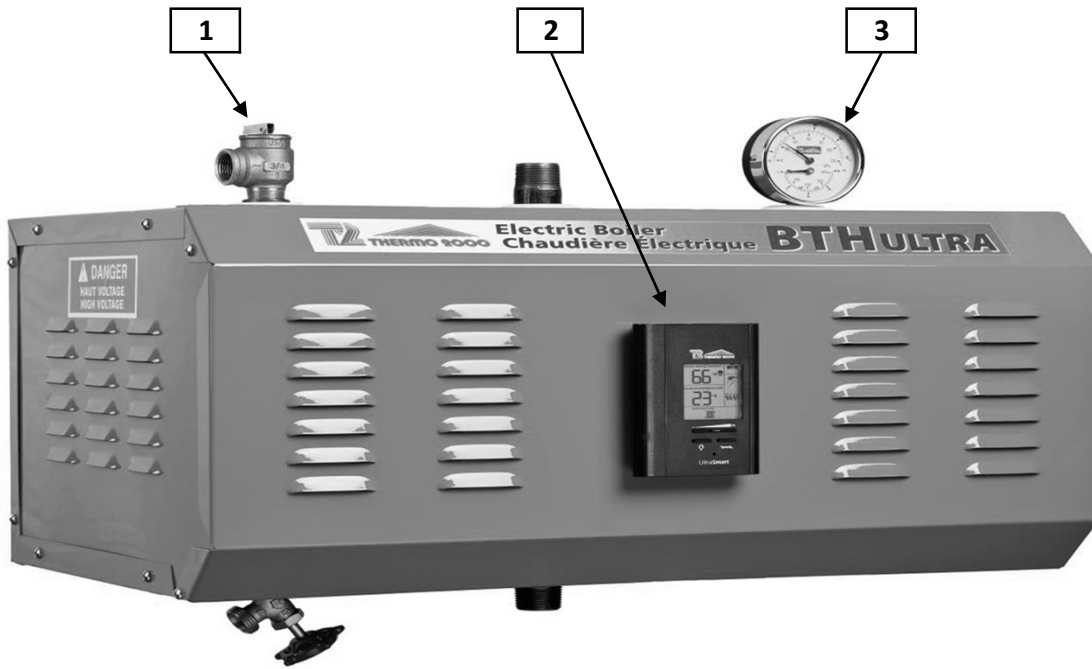

BTH ULTRA (2014 models and less)**Electric Boiler****Models from 6 kW to 33 kW : 240V (single phase)**

Item	Part number	Models	Description
1	ZMC200-SV30PSI1	All	Safety Valve 30 psi, ¼"
2	ZEL100-ULTRA	All	UltraSmart Controller
3	ZMC300-75P160CN	All	Temperature and Pressure Indicator
4	ZEL100-SENSUNI	All	Boiler temperature sensor
5	ZEL200-L6C732	All	High-Limit automatic reset Switch
6	ZEL100-24ACNO30	All	Power relay 24Vac
7	ZEL400-120V40VA	All	Transformer 120V/24V 40VA
8	ZEL300-240V3KW	6kW ; 8kW ; 12kW ; 15kW	Heating element 3 kW 240V
	ZEL300-240V45KW	15kW ; 18kW ; 27kW	Heating element 4.5 kW 240V
	ZEL300-240V5KW	8 ; 10 ; 20kW ; 30kW ; 33kW	Heating element 5 kW 240V
	ZEL300-240V6KW	24kW ; 33kW	Heating element 6 kW 240V
9	ZEL800-3P115600	6kW to 10kW	Terminal Block 600V 3Poles 115A
	ZEL800-3P175600	12kW to 33kW	Terminal Block 600V 3Poles 175A
10	ZEL900-2P60A	30kW ; 33kW	Braker 2 poles 60A
11	ZEL250-TDCC15A	All	Time Delay Fuse 600V 15 Amp Class CC
12	ZEL100-2PC50120	6kW to 10kW	2 poles Contactor 120Vac
	ZEL100-4P50A120	12kW to 24kW	4 poles Contactor 120Vac
	ZEL100-3P50A120	27kW to 33kW	3 poles Contactor 120Vac

DTH

Electric Boiler

Models from 42 kW to 144 kW : 240V (single phase) and 480/600V (3 phases)

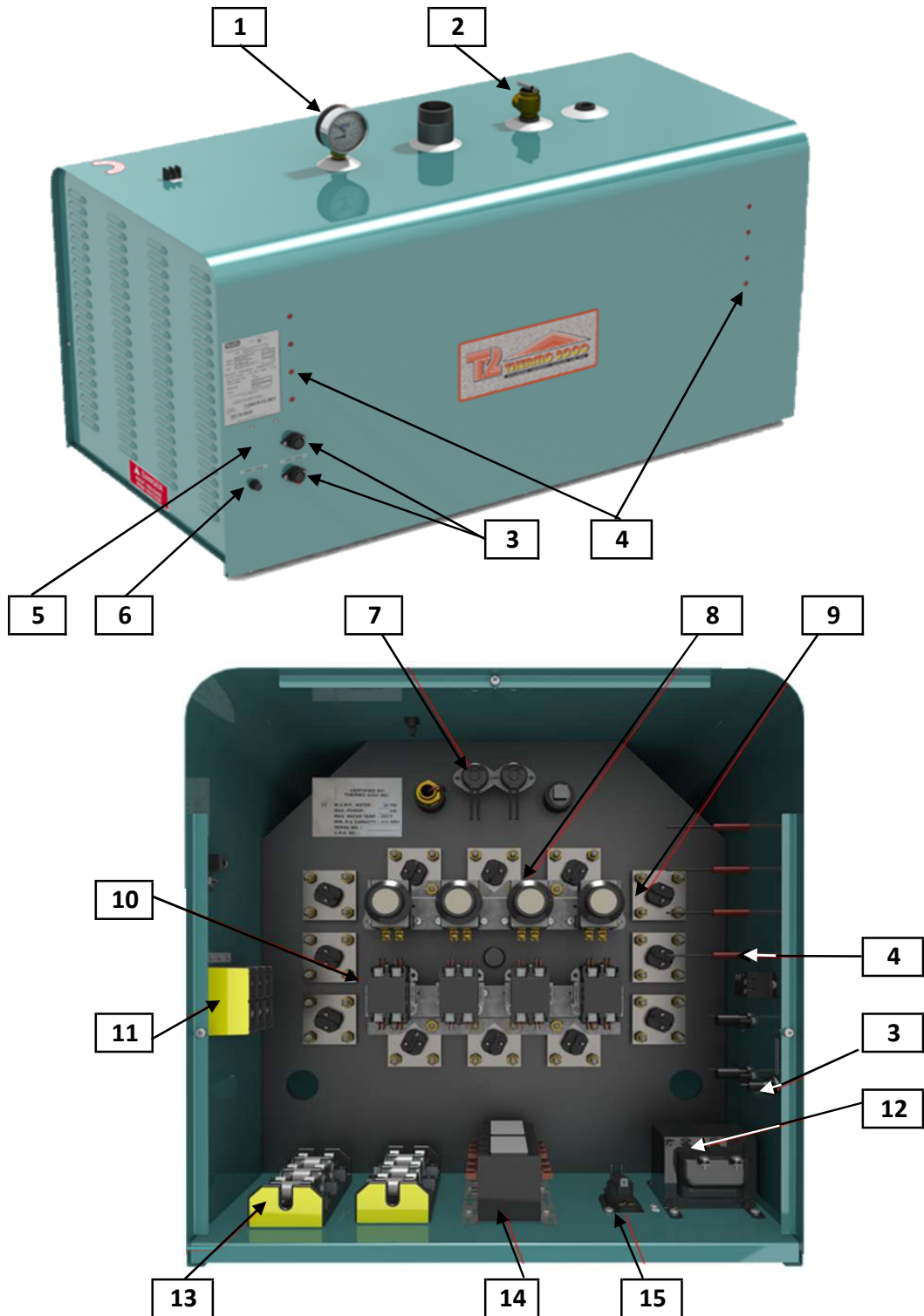

Models from 42 kW to 144 kW : 240V (single phase) and 480/600V (3 phases)

Item	Part number	Models	Description
1	ZMC300-75P160CN	All	Temperature and Pressure Indicator
2	ZMC200-SV30PSI1	72kW and under	Safety Valve 30 psi, ¾"
	ZMC200-SV60PSI1	78kW and over or option	Safety Valve 60 psi, ¾"
3	ZEL250-FAMIDJ1A	All	Fuse 1 amp.
4	ZEL150-120VAMB	480V and 600V models	Indicating lamp
	ZEL150-240VRED	240V models	Indicating lamp
5	ZEL250-FAGLAS1A	All	Fuse 1 amp.
6	ZEL200-NIV120V	All	Low water cut-off
7	ZEL200-L6C732	All	High-Limit automatic reset Switch
8	ZEL200-G111781	All	Temperature control
9	ZEL300-240V6KW	240V models	Heating element 6 kW 240V
	ZEL300-277V5KW	480V models	Heating element 5 kW 277V
	ZEL300-277V6KW	480V models	Heating element 6 kW 277V
	ZEL300-347V5KW	600V models	Heating element 5 kW 347V
	ZEL300-347V6KW	600V models	Heating element 6 kW 347V
10	ZEL100-2PC50120	480V and 600V models	2 poles Contactor 120Vac
11	ZEL800-2P380600	240V models	Terminal Block 600V 2Poles 380A
	ZEL800-3P175600	480V and 600V models	Terminal Block 600V 3Poles 175A
12	ZEL400-240100VA	240V models	Transformer 240V/120V 100VA
	ZEL400-600200VA	Modèle 600V	Transformer 600V/120V 200VA
13	ZEL900-2P60A	240V models	Braker 2 poles 60A
	ZEL250-FAT50A	480V and 600V models	Fast Acting Fuse 600V 50 Amp Class T
14	ZEL100-2PC50120	480V and 600V models	2 poles Contactor 120Vac
	ZEL100-3P50A120	480V and 600V models	3 poles Contactor 120Vac
	ZEL100-4P50A120	240V models	4 poles Contactor 120Vac
	ZEL100-2PC50240	2008 models and less	2 poles Contactor 240Vac
	ZEL100-3P50A240	2008 models and less	3 poles Contactor 240Vac
	ZEL100-4P50A240	2008 models and less	4 poles Contactor 240Vac
15	ZEL200-SEQ120NO	All	Simple sequencer

INSTOMAX

Instantaneous water heater

Power capacity from 4.5 kW to 12 kW : 240V (single phase)

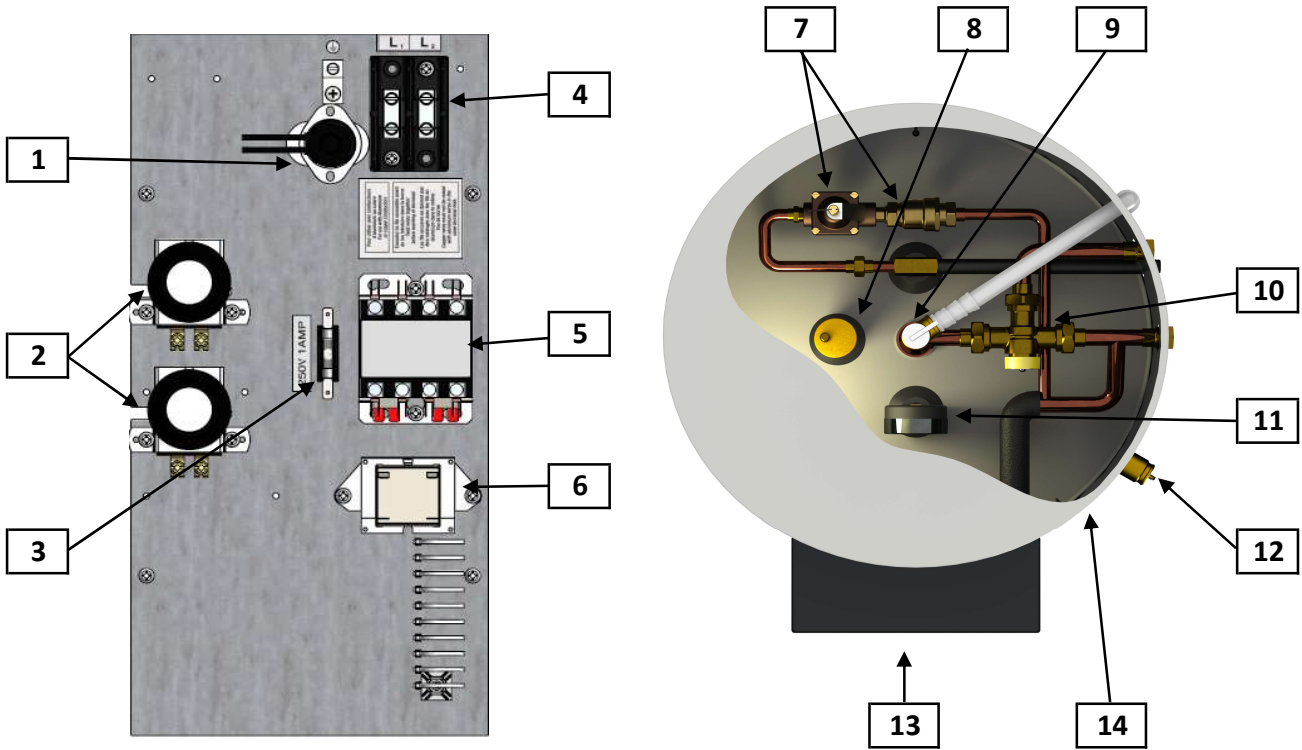

Item	Part number	Models	Description
1	ZEL200-HL195F	All	High-Limit automatic reset Switch
2	ZEL200-G111781	All	Temperature control
3	ZEL250-FAGLAS1A	All	Fuse 1 amp.
4	ZEL800-2P115600	All	Terminal Block 600V 2Poles 115A
5	ZEL100-4P50A24	All	4 poles Contactor 24Vac
6	ZEL400-20842440	All	Transformer 208V-240V/24V 40VA
7	ZMC950-PRES&CHK	All	Pressure reducer and check valve
8	ZMC600-AV1/2	All	Air vent 1/2"
	ZMC600-CV1/2	All	Check valve
9	ZMC200-SVTP125	All	Safety Relief Valve 125 psi, 3/4"
10	ZMC200-MIX34SWT	All	Mixing Valve 100F-145F
11	ZMC300-120PT4PO	All	Temperature and Pressure Indicator
12	ZMC200-SV30PSI2	All	Safety Valve 30 psi, 3/4"
13	ZEL300-240V3KW	7.5kW	Heating element 3 kW 240V
	ZEL300-240V45KW	4.5kW ; 9kW	Heating element 4.5 kW 240V
	ZEL300-240V6KW	6kW ; 12kW	Heating element 6 kW 240V
14	ZEL150-240VRED	All	Indicating lamp

COMBOMAX RESIDENTIAL

Combined electric boiler and instantaneous water heater

Models 23 to 64 with Power capacity from 8 kW to 24 kW : 240V (single phase)

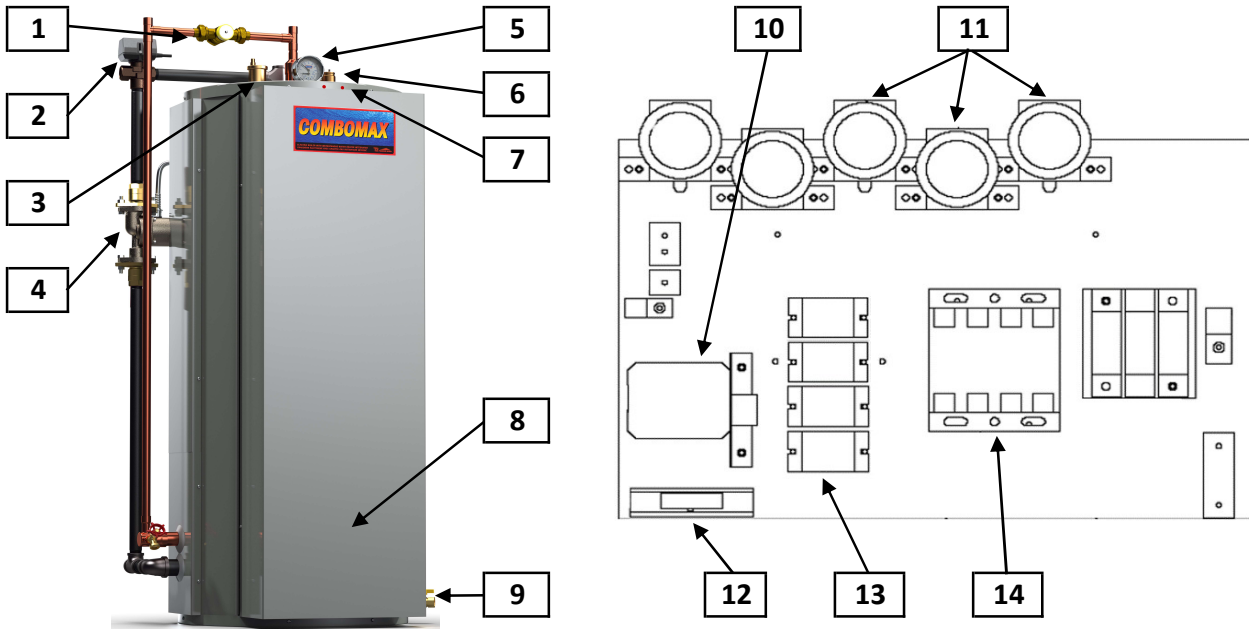

Item	Part number	Models	Description
1	ZMC200-MIX34SWT	All	Mixing Valve 100F-145F
2	ZMC200-3WV1NPT	All	3 Way Valve Body 1" NPT
	ZMC200-VA2P24V	All	Valve Actuator 24V
3	ZMC600-AV1/2	All	Air vent 1/2"
	ZMC600-CV1/2	All	Check valve
4	ZMC960-UPS15RU	All	Recirculating pump
5	ZMC300-120PT4PO	All	Temperature and Pressure Indicator
6	ZMC200-SV30PSI2	All	Safety Valve 30 psi, 3/4"
7	ZEL150-240VRED	All	Indicating lamp
8	ZEL300-240V3KW	8kW ; 15kW	Heating element 3 kW 240V
	ZEL300-240V45KW	15kW ; 18kW	Heating element 4.5 kW 240V
	ZEL300-240V5KW	8kW ; 10kW ; 20kW	Heating element 5 kW 240V
	ZEL300-240V6KW	24kW	Heating element 6 kW 240V
9	ZMC200-BVP34NPT	All	Drain valve 3/4"
10	ZEL400-120V40VA	All	Transformer 120V/24V 40VA
11	ZEL200-G111781	All	Temperature control
12	ZEL250-TDCC6/10	All	Time Delay Fuse 600V 6/10 Amp Class CC
	ZEL250-TDCC15A	All	Time Delay Fuse 600V 15 Amp Class CC
13	ZEL100-24ACSPST	All	Power relay 24Vac
14	ZEL100-2PC50120	8kW ; 10kW	2 poles Contactor 120Vac
	ZEL100-4P50A120	15kW to 24kW	4 poles Contactor 120Vac