



Lucky Dog™

Manufactured by
Jewett-Cameron Company
CUSTOMER SERVICE
1-800-955-2879

CHAINLINK OUTDOOR KENNELS

ASSEMBLY INSTRUCTIONS *scan QR code for video*



5ft. Wide x 10ft. Long x 4ft./6ft. High (pg. 5 & 6)

8ft. Wide x 6.5ft. Long x 4ft./6ft. High (pg. 8 & 9)



5ft. x 10ft.



8ft. x 6.5ft.

5ft. Wide x 15ft. Long x 6ft. High (pg. 4 & 6)

10ft. x 10ft. x 6ft. High (pg. 7 & 9)



5ft. x 15ft.

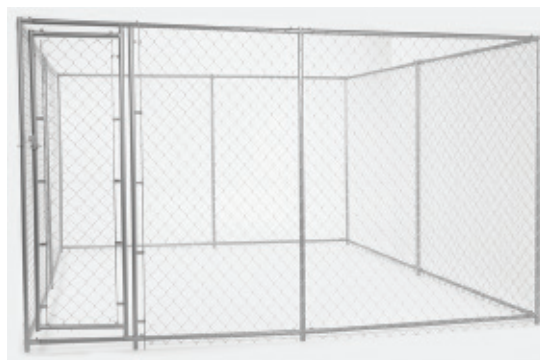

10ft. x 10ft.

TABLE OF CONTENTS

Parts Identifier & Quantities	Pg. 2
Gate Assembly	Pg. 3
5'x15' Kennel	Pg. 4
5'x10' Kennel	Pg. 5
5' x 10' & 5' x 15' Assembly Cont'	Pg.6
10'x10' Kennel	Pg. 7
8.5'x6' Kennel	Pg. 8
10' x 10' & 8.5' x 6' Assembly Cont'	Pg.9
Warranty	Pg. 10
Cover Installation	Pg. 11
Anchor & Windscreen Installation	Pg. 12
<i>(covers and accessories are sold separately)</i>	

IMPORTANT NOTICE!

PLEASE READ INSTRUCTIONS COMPLETELY PRIOR TO ASSEMBLING YOUR LUCKY DOG™ CHAIN LINK OUTDOOR KENNEL.

Watch for helpful “HINTS” when following these instructions.

Approximate assembly time with 2 people: 1-2 hours

STEP 1 PARTS LIST

Separate and identify all parts A-K, as shown below

TOOLS NEEDED



STEP 2 SITE PREPARATION

Choosing your kennel location is very important to the well being and safety of your pet companion. The site should be flat and clear of foreign objects and should be protected from sun and other weather elements that may be harmful to your pet.

PARTS IDENTIFIER, A - K

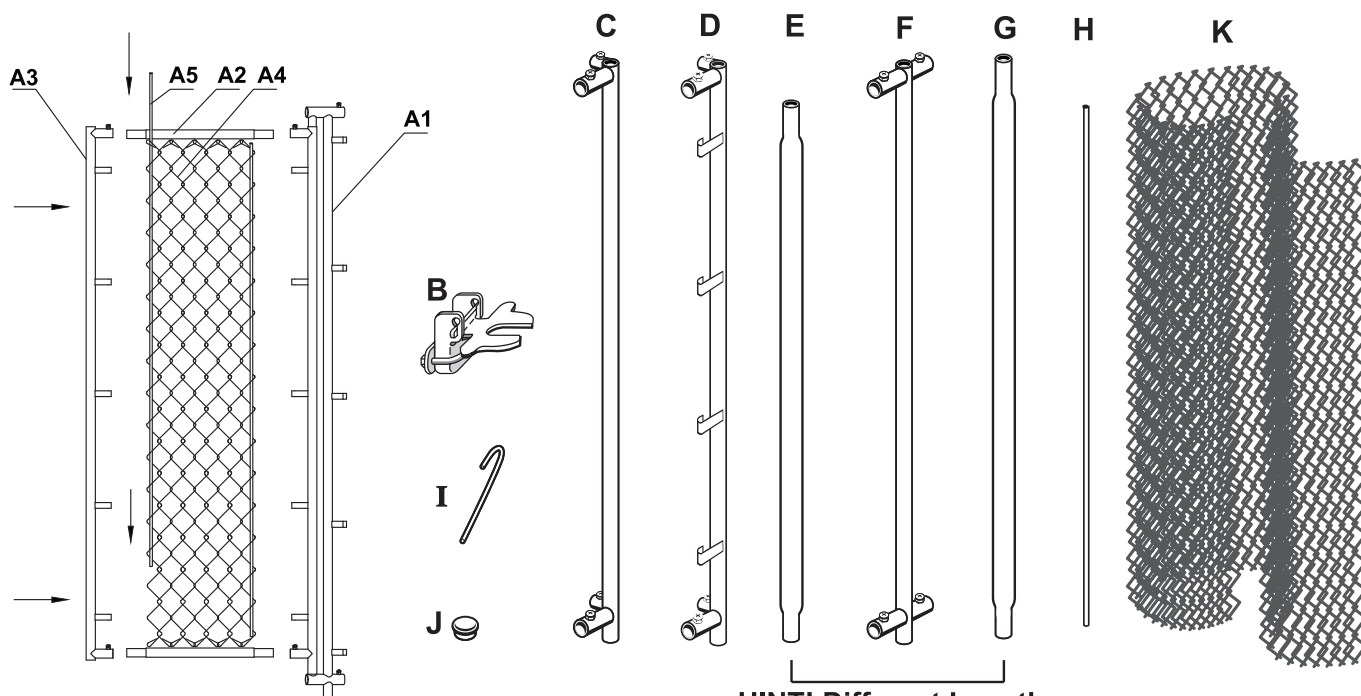

HINT! Different Lengths

Parts A1-A5 combine to make Part A - SWINGING GATE

- A1:** Gate Stand - Swinging side (1)
- A2:** Upper & Lower Spreader bars (2)
- A3:** Gate Stand - Latch side (1)
- A4:** Chain Link piece for Gate (1)
- A5:** Round Tension Rods (for gate, shorter ones) (2)

- B:** Lockable Gate Latch
- C:** Corner Stands NO Rod Clips
- D:** Corner Stand WITH Rod Clips
- E:** Upper & Lower END Railings
- F:** Center Stands
- G:** Upper & Lower SIDE Railings
- H:** Round Tension Rods (for kennel)
- I:** Steel Wire Ties
- J:** Pole Caps
- K:** Chain link Roll for kennel

	5 x10	5x15
	8x6.5	10x10

1	1
3	3
1	1
12	4
4	4
4	12
2	2
49	64
9	9
1	1

STEP 3 ASSEMBLING THE SWINGING GATE

HINT! Assemble the gate first and set it aside before assembling the kennel frame.

A1: Gate Stand - Swinging side (1)
A2: Upper & Lower Spreader bars (2)
A3: Gate Stand - Latch side (1)

A4: Chain Link piece for Gate (1)
A5: Round Tension Rods (for gate, shorter ones) (2)

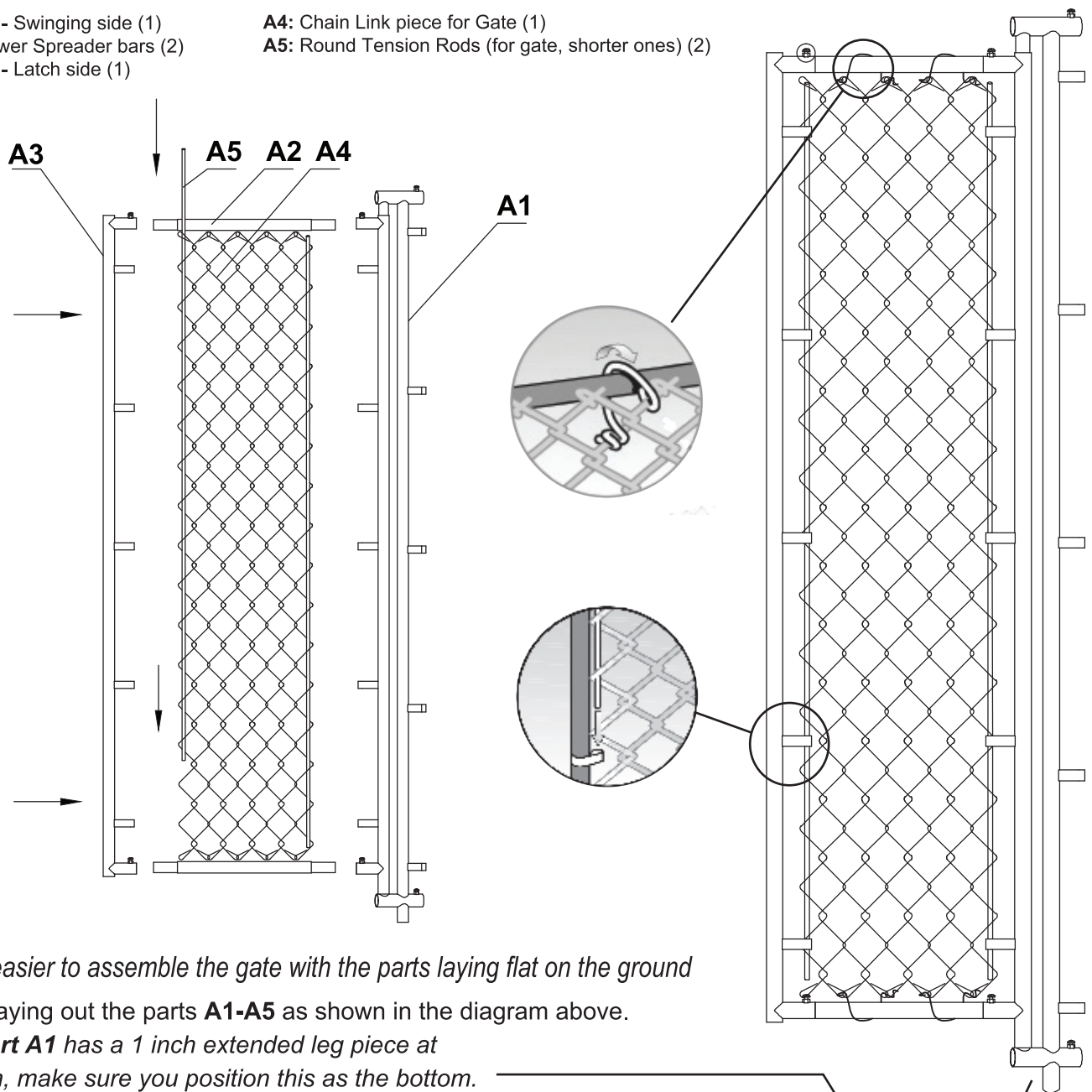

HINT! It is easier to assemble the gate with the parts laying flat on the ground

1. Begin by laying out the parts **A1-A5** as shown in the diagram above.

NOTE: **Part A1** has a 1 inch extended leg piece at the bottom, make sure you position this as the bottom.

2. Insert parts **A2 (UPPER & LOWER SPREADER BARS)** into the receiving tube pieces on part **A1**. Make sure tubes are fully inserted, then tighten set screws.

3. Now attach part **A3 (GATE STAND, LATCH SIDE)** to the upper and lower spreader bars, make sure it is fully inserted, tighten set screws.

4. Attaching the chain link mesh - Run **TENSION RODS, Part A5** through the sides of the **CHAIN LINK MESH, Part A4**. Now attach the tension rods to the clips on the gate stands, as shown.

5. Secure the chain link to the gate frame with **STEEL WIRE TIES, Part I**.
2-3 on the top, 2-3 on the bottom.

HINT! Ensure the ends of the steel wire ties are pointing away from the inside of the kennel, to avoid injury to your pet.

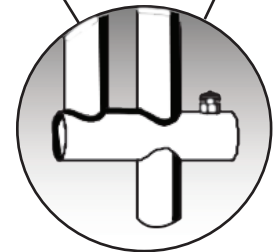

STEP 4A ASSEMBLING THE KENNEL FRAMEWORK - 5ft.x15ft. ONLY (see pg. 5 for 5x10 / pg. 7 for 10ft. x 10ft. / pg. 8 for 8ft. x 6.5ft.)

Begin by laying your assembled gate (A) mesh side (face) down. Loosen the set-screws on the top and bottom of the **RECEIVER TUBES** of the gate (see illustration below) and slide top and bottom **END RAILS (E)** through the receiver tubes. **DO NOT TIGHTEN THE SET SCREWS YET**, they will need to be loose in a later step to adjust the gate.

STEP 5A

(Still laying face down) Attach **CORNER STAND WITH ROD CLIPS (D)** to the upper and lower end rails, on the latch side of the gate (figure 1). Tighten set screws. *Be careful not to over-tighten, as this may cause damage to the welded nut.*

STEP 6A

Attach **CORNER STAND WITHOUT ROD CLIPS (C)** to the other side of the upper and lower end rails. Tighten set screws. Do not over-tighten.

STEP 7A

Now insert **2 BOTTOM SIDE RAILS (G)** into the bottoms of the corner stands. Tighten set screws. You can now carefully stand this side upright.

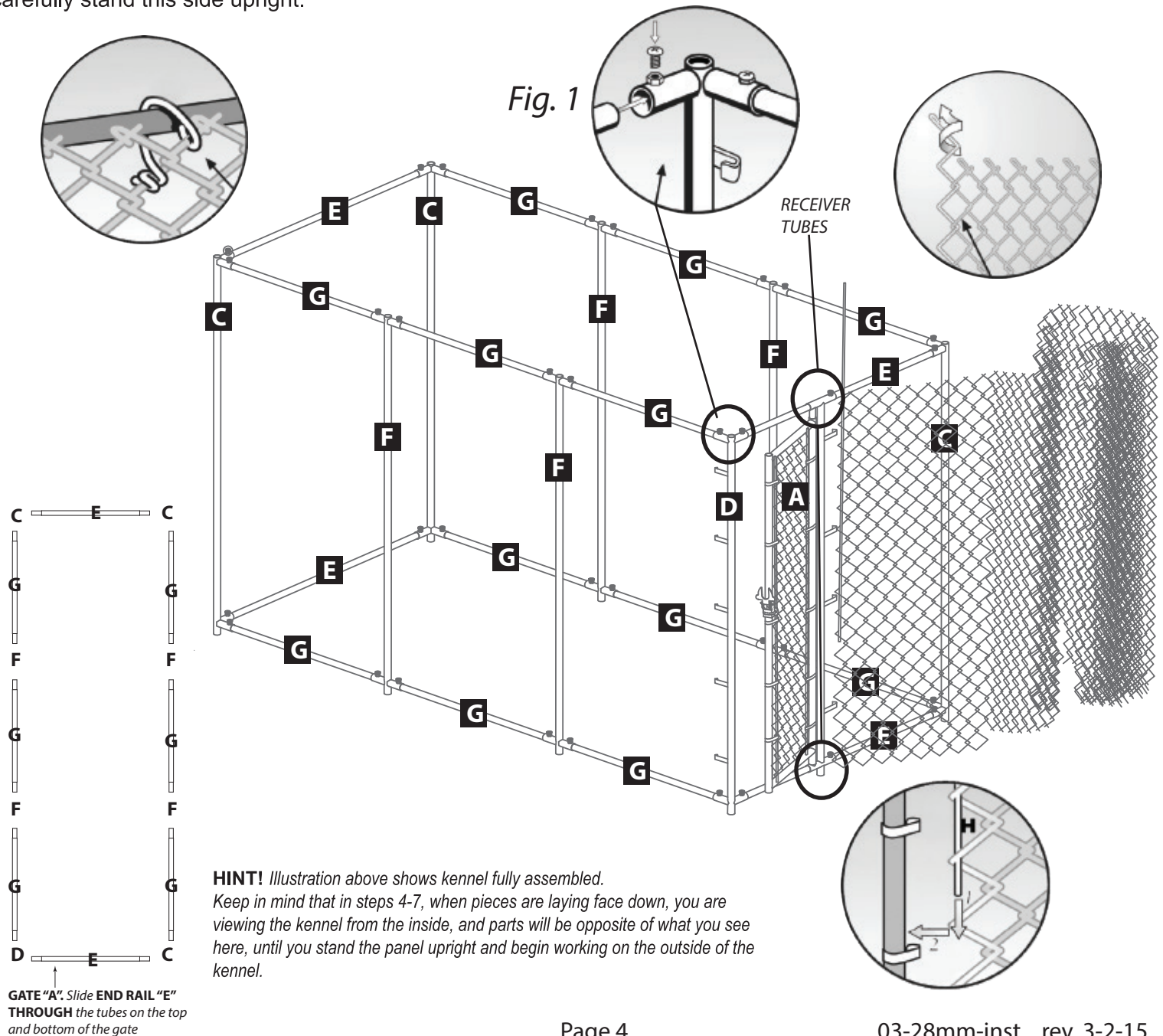

HINT! Illustration above shows kennel fully assembled. Keep in mind that in steps 4-7, when pieces are laying face down, you are viewing the kennel from the inside, and parts will be opposite of what you see here, until you stand the panel upright and begin working on the outside of the kennel.

STEP 4A ASSEMBLING THE KENNEL FRAMEWORK - 5ft.x10ft. ONLY (see pg. 4 for 5x15 / pg. 7 for 10ft. x 10ft. / pg. 8 for 8ft. x 6.5ft.)

Begin by laying your assembled gate (A) mesh side (face) down. Loosen the set-screws on the top and bottom of the **RECEIVER TUBES** of the gate (see illustration below) and slide top and bottom **END RAILS (G)** through the receiver tubes. **DO NOT TIGHTEN THE SET SCREWS YET**, they will need to be loose in a later step to adjust the gate.

STEP 5A

(Still laying face down) Attach **CORNER STAND WITH ROD CLIPS (D)** to the upper and lower end rails, on the latch side of the gate (figure 1). Tighten set screws. *Be careful not to over-tighten, as this may cause damage to the welded nut.*

STEP 6A

Attach **CORNER STAND WITHOUT ROD CLIPS (C)** to the other side of the upper and lower end rails. Tighten set screws. Do not over-tighten.

STEP 7A

Now insert **2 BOTTOM SIDE RAILS (E)** into the bottoms of the corner stands. Tighten set screws. You can now carefully stand this side upright.

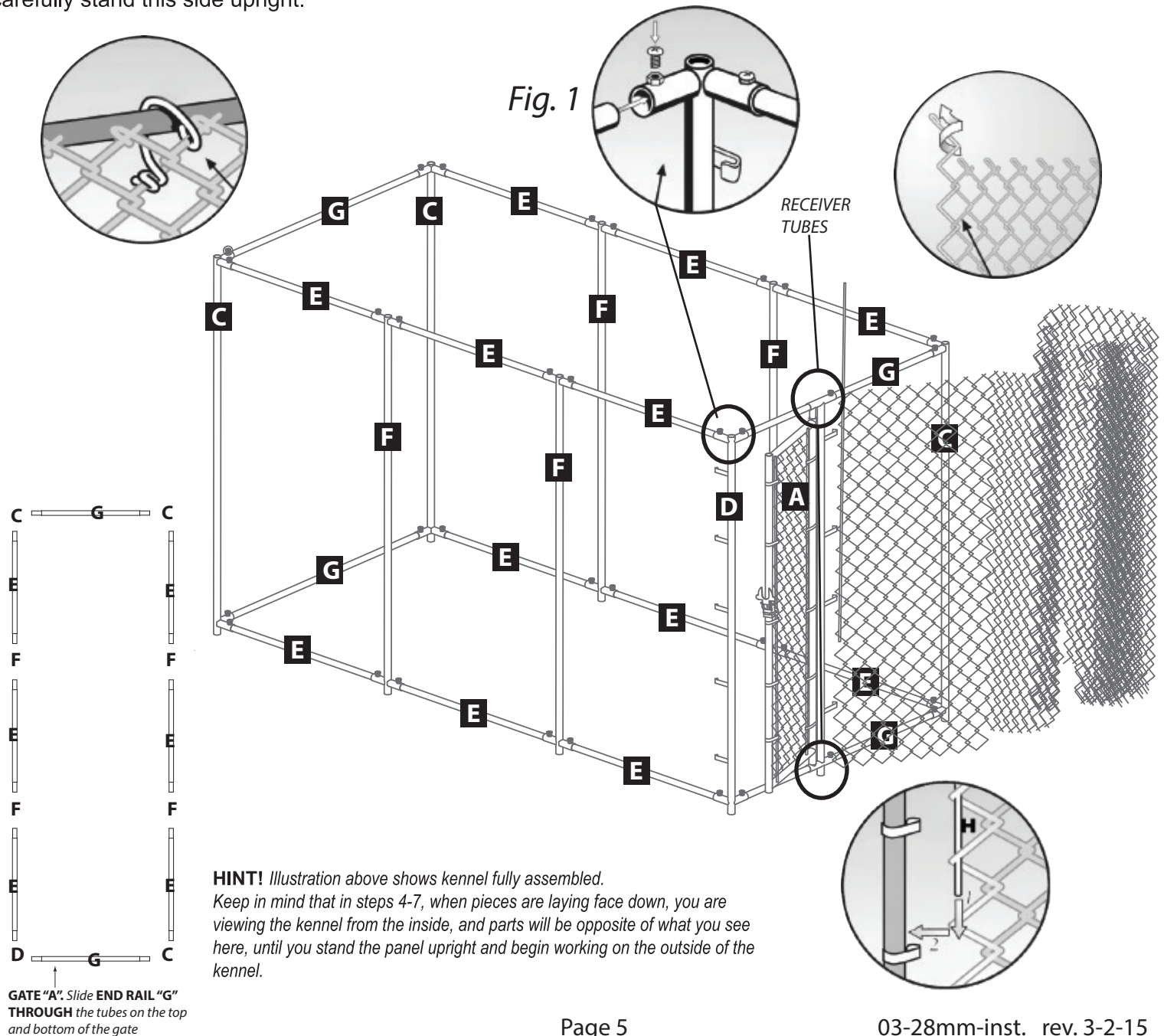

HINT! Illustration above shows kennel fully assembled. Keep in mind that in steps 4-7, when pieces are laying face down, you are viewing the kennel from the inside, and parts will be opposite of what you see here, until you stand the panel upright and begin working on the outside of the kennel.

GATE "A": Slide END RAIL "G" THROUGH the tubes on the top and bottom of the gate

STEP 8

Now insert **2 SIDE RAILS (G)** into the tops of the corner stands. Tighten set screws.

STEP 9

Attach **CENTER STANDS (F)** to the top and bottom side rails on each side of the kennel, tighten set screws.

Remember to keep the 1 inch leg extensions on the bottom.

HINT! *Larger kennels have more than one CENTER STAND per side.*

STEP 10

Continue installation with top and bottom side rails **(G)** on each side, then **CORNER STANDS WITHOUT ROD CLIPS (C)**, finish with **END RAILS (E)** along the back of the kennel. Tightening set screws as you go. Your frame should now be complete.

STEP 11 - CHAIN LINK MESH INSTALLATION

For ease of shipping, the roll of chain link is folded versus rolled. The recommended handling of this mesh is to unfold it onto a flat surface, checking along the top and bottom for any pickets that may have come unhooked, from each other or that need to be twisted back into place.

After checking, roll the chain link back up like you would a carpet. This will allow ease of handling when you attach it to the frame.

STEP 12

Working on the **OUTSIDE** of the kennel, stand the chain link next to the **CORNER STAND WITH ROD CLIPS (D)**, insert a **ROUND TENSION ROD (H)** through the edge of the chain link, hook the tension rod onto the clips. (figure 2)

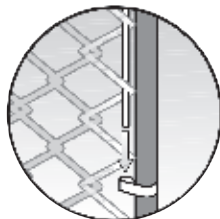

Figure 2

STEP 13

Unroll the chain link mesh around the outside of the kennel frame, pull the chain link tight at each **CENTER AND CORNER STAND**, as you work your way around the kennel and secure the chain link to the top and bottom rails, Using **STEEL WIRE TIES (I)** to keep it from sliding back and becoming loose. (figure 3)



Figure 3

STEP 14 - GATE LATCH

Attach **LOCKABLE GATE LATCH (B)** to the latch side of the gate frame, at the desired height. Tighten bolts until latch is firmly attached to frame. Slide the gate into position leaving approximately 2 inches between the gate and the corner stand, (figure 4)

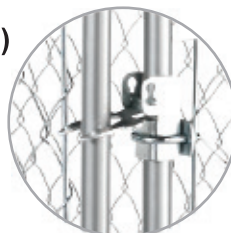

Figure 4

Make sure the latch opens and closes easily.

Now you can tighten the set screws on the gate, that were left loose in step 4. (figure 5)

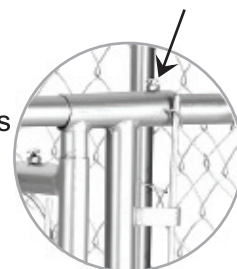

Figure 5

STEP 15

Once you have completely unrolled the chain link mesh around the entire kennel frame, install the remaining **TENSION ROD (H)** through the edge of the chain link and clip it to the rod clips on the gate frame. (figure 6)

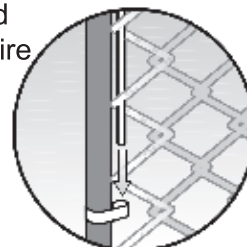

Figure 6

HINT! *The chain link mesh is pre-cut to easily fit the kennel size, however exact length is not always possible. Therefore, one or more chain link pickets may need to be removed to insure proper tension on the mesh. If pickets need to be removed, straighten out the ends of as many pickets as necessary at top and bottom and twist out the picket. (figure 7)*

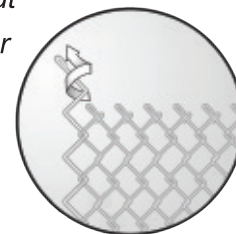

Figure 7

STEP 16

Using the remaining wire ties **(I)**, secure the mesh to the top and bottom rails (figure 3). The top wire ties should be approximately 18 inches apart, the bottoms 12 inches. If you have any wire ties left over, use them at the center and corner stands.

HINT! *Remember to keep the tail ends of the wire ties pointing toward the outside of the kennel to keep your pet from coming in contact with them.*

CONGRATULATIONS! *You now have a quality kennel product for your pet companion, that will provide you with many years of use when cared for properly.*

HINT! *Optional kennel covers for the protection of your pet are available. Please visit www.jewettcameron.com for more details.*

STEP 4B ASSEMBLING THE KENNEL FRAMEWORK - 10ft.x10ft. ONLY (see pg. 4 for 5ft. x 15ft. /pg. 5 for 5x10 / pg. 8 for 8ft. x 6.5ft.)

Begin by laying your assembled gate (A) mesh side (face) down. Loosen the set-screws on the top and bottom of the **RECEIVER TUBES** of the gate (see illustration below) and slide top and bottom **END RAILS (E)** through the receiver tubes. **DO NOT TIGHTEN THE SET SCREWS YET**, they will need to be loose in a later step to adjust the gate.

STEP 5B

(Still laying face down) Attach **CORNER STAND WITH ROD CLIPS (D)** to the upper and lower end rails, on the latch side of the gate (figure 1). Tighten set screws. *Be careful not to over-tighten, as this may cause damage to the welded nut.*

STEP 6B

Attach **CENTER STAND (F)** to the other side of the upper and lower end rails. Next, attach **UPPER & LOWER SIDE RAILS (G)** to the open end of **CENTER STAND (F)**. Tighten set screws. Do not over tighten.

STEP 7B

Attach **CORNER STAND WITHOUT ROD CLIPS (C)** to the other side of the upper & lower side rails. Tighten set screws. Do not over tighten. You can now carefully stand this side upright.

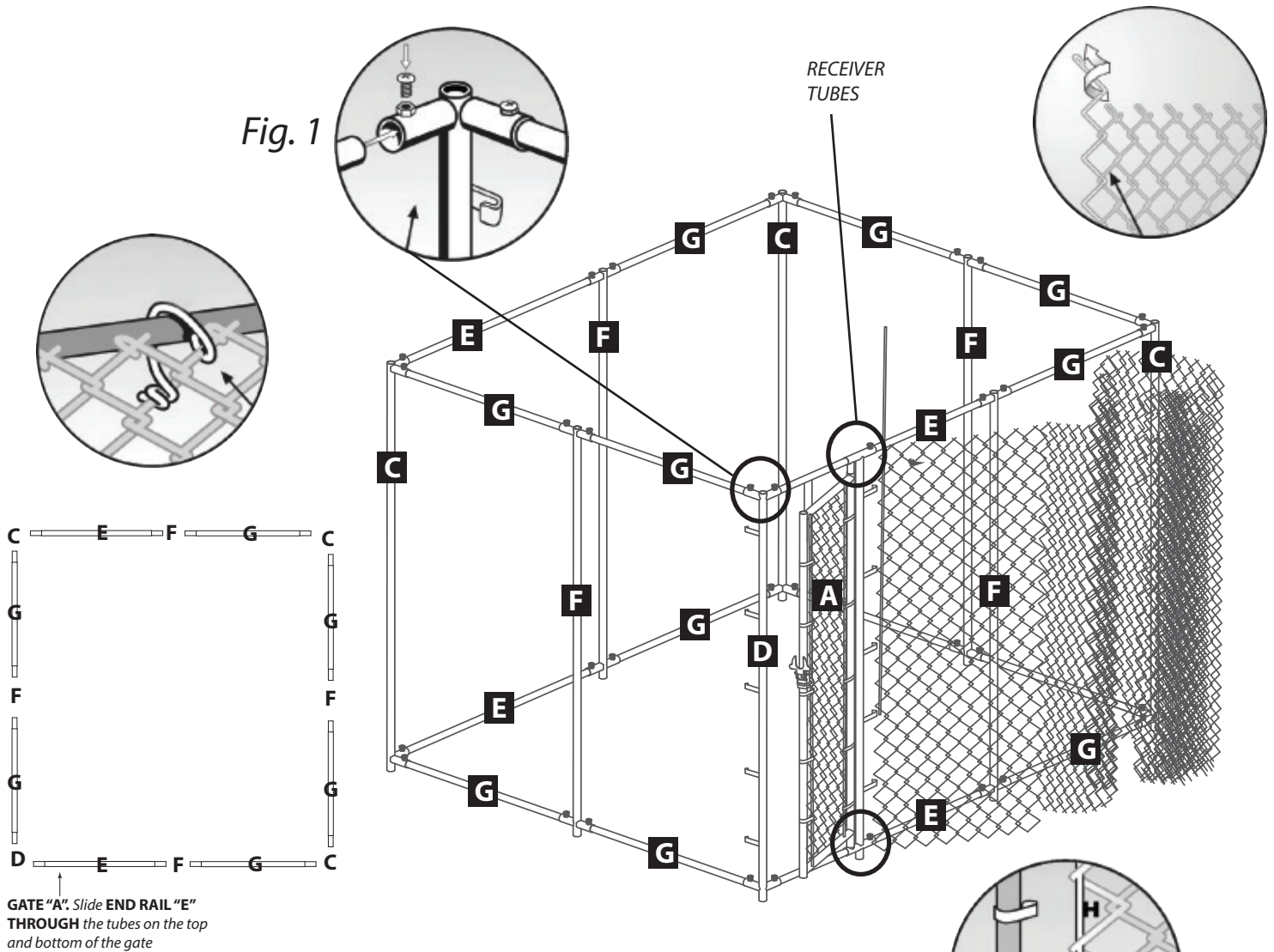

HINT! Illustration above shows kennel fully assembled. Keep in mind that in steps 4-7, when pieces are laying face down, you are viewing the kennel from the inside, and parts will be opposite of what you see here, until you stand the panel upright and begin working on the outside of the kennel.

STEP 4B ASSEMBLING THE KENNEL FRAMEWORK - 8.5ft.x6ft. ONLY (see pg. 4 for 5ft. x 15ft. /pg. 5 for 5x10 / pg. 7 for 10ft. x 10ft.)

Begin by laying your assembled gate (A) mesh side (face) down. Loosen the set-screws on the top and bottom of the RECEIVER TUBES of the gate (see illustration below) and slide top and bottom END RAILS (G) through the receiver tubes. **DO NOT TIGHTEN THE SET SCREWS YET**, they will need to be loose in a later step to adjust the gate.

STEP 5B

(Still laying face down) Attach **CORNER STAND WITH ROD CLIPS (D)** to the upper and lower end rails, on the latch side of the gate (figure 1). Tighten set screws. *Be careful not to over-tighten, as this may cause damage to the welded nut.*

STEP 6B

Attach **CENTER STAND (F)** to the other side of the upper and lower end rails. Next, attach **UPPER & LOWER SIDE RAILS (E)** to the open end of **CENTER STAND (F)**. Tighten set screws. Do not over tighten.

STEP 7B

Attach **CORNER STAND WITHOUT ROD CLIPS (C)** to the other side of the upper & lower side rails. Tighten set screws. Do not over tighten. You can now carefully stand this side upright.

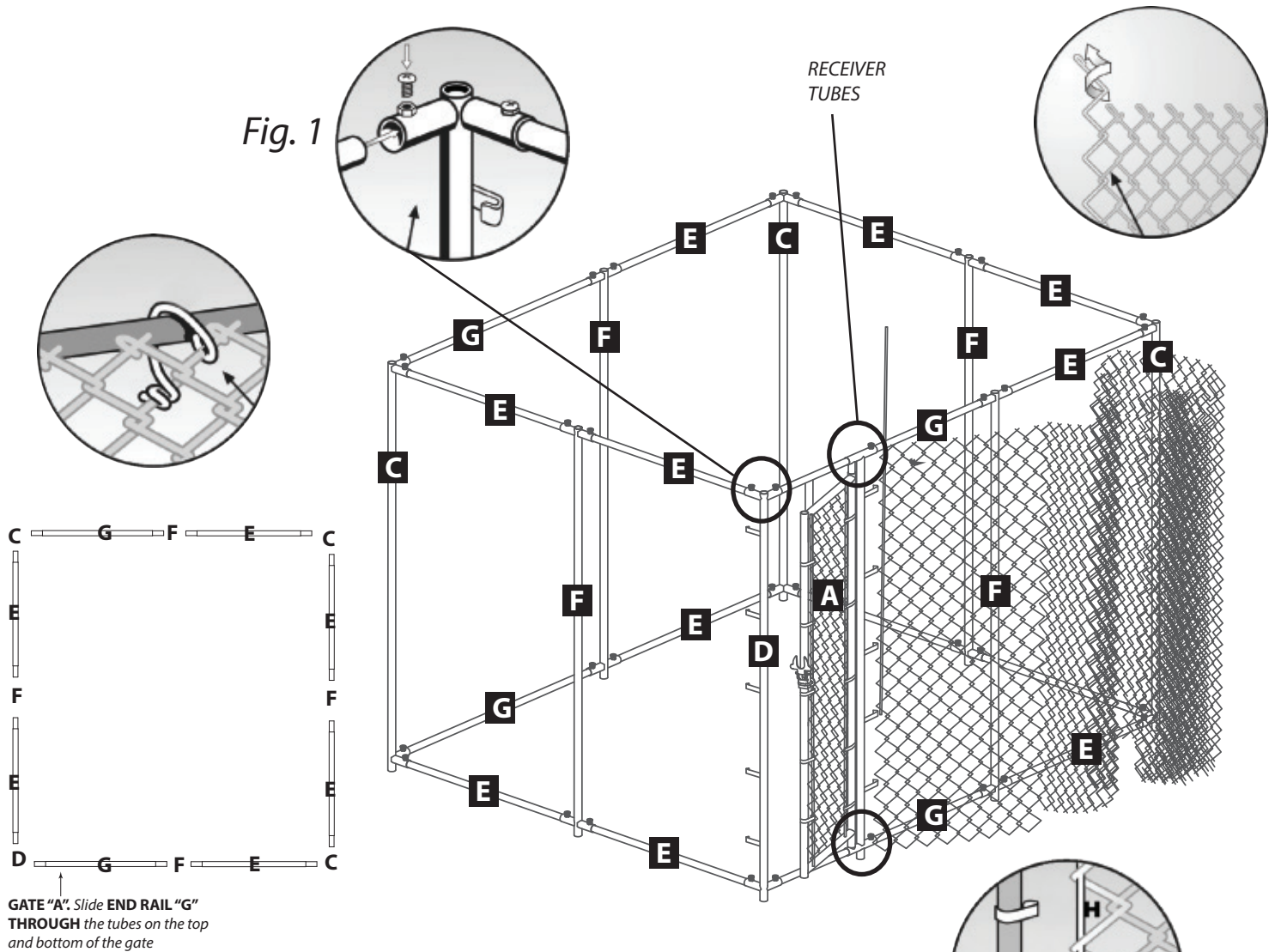

Fig. 1

GATE "A". Slide END RAIL "G" THROUGH the tubes on the top and bottom of the gate

HINT! Illustration above shows kennel fully assembled. Keep in mind that in steps 4-7, when pieces are laying face down, you are viewing the kennel from the inside, and parts will be opposite of what you see here, until you stand the panel upright and begin working on the outside of the kennel.

STEP 8

Now insert **2 SIDE RAILS (G)** into the tops of the corner stands. Tighten set screws.

STEP 9

Attach **CENTER STANDS (F)** to the top and bottom side rails on each side of the kennel, tighten set screws.

Remember to keep the 1 inch leg extensions on the bottom.

HINT! Larger kennels have more than one **CENTER STAND** per side.

STEP 10

Continue installation with top and bottom side rails **(G)** on each side, then **CORNER STANDS WITHOUT ROD CLIPS (C)**, finish with **END RAILS (E)** along the back of the kennel. Tightening set screws as you go. Your frame should now be complete.

STEP 11 - CHAIN LINK MESH INSTALLATION

For ease of shipping, the roll of chain link is folded versus rolled. The recommended handling of this mesh is to unfold it onto a flat surface, checking along the top and bottom for any pickets that may have come unhooked, from each other or that need to be twisted back into place.

After checking, roll the chain link back up like you would a carpet. This will allow ease of handling when you attach it to the frame.

STEP 12

Working on the **OUTSIDE** of the kennel, stand the chain link next to the **CORNER STAND WITH ROD CLIPS (D)**, insert a **ROUND TENSION ROD (H)** through the edge of the chain link, hook the tension rod onto the clips. (figure 2)

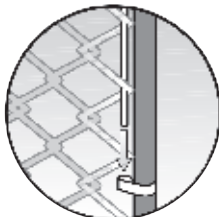

Figure 2

STEP 13

Unroll the chain link mesh around the outside of the kennel frame, pull the chain link tight at each **CENTER AND CORNER STAND**, as you work your way around the kennel and secure the chain link to the top and bottom rails, Using **STEEL WIRE TIES (I)** to keep it from sliding back and becoming loose. (figure 3)



Figure 3

STEP 14 - GATE LATCH

Attach **LOCKABLE GATE LATCH (B)** to the latch side of the gate frame, at the desired height. Tighten bolts until latch is firmly attached to frame. Slide the gate into position leaving approximately 2 inches between the gate and the corner stand, (figure 4)

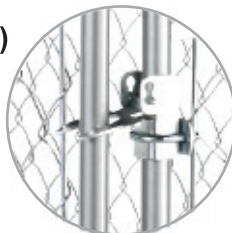

Figure 4

Make sure the latch opens and closes easily.

Now you can tighten the set screws on the gate, that were left loose in step 4. (figure 5)

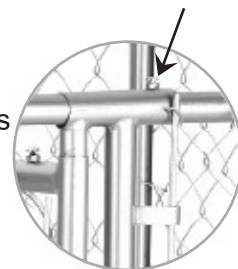

Figure 5

STEP 15

Once you have completely unrolled the chain link mesh around the entire kennel frame, install the remaining **TENSION ROD (H)** through the edge of the chain link and clip it to the rod clips on the gate frame. (figure 6)

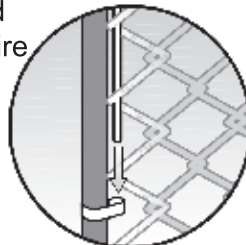

Figure 6

HINT! The chain link mesh is pre-cut to easily fit the kennel size, however exact length is not always possible. Therefore, one or more chain link pickets may need to be removed to insure proper tension on the mesh. If pickets need to be removed, straighten out the ends of as many pickets as necessary at top and bottom and twist out the picket. (figure 7)

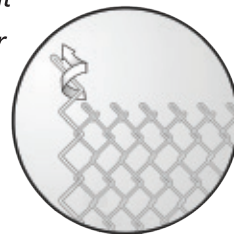

Figure 7

STEP 16

Using the remaining wire ties **(I)**, secure the mesh to the top and bottom rails (figure 3). The top wire ties should be approximately 18 inches apart, the bottoms 12 inches. If you have any wire ties left over, use them at the center and corner stands.

HINT! Remember to keep the tail ends of the wire ties pointing toward the outside of the kennel to keep your pet from coming in contact with them.

CONGRATULATIONS! You now have a quality kennel product for your pet companion, that will provide you with many years of use when cared for properly.

HINT! Optional kennel covers for the protection of your pet are available. Please visit www.jewettcameron.com for more details.

EXTREMELY IMPORTANT!

Pet companions are very comfortable in the safety enclosure: however, it is suggested that there be a brief introduction period to acclimate your pet companion. To begin this process, place your pet in the kennel for short periods of time (10-20 minutes) throughout the day while you are able to observe their behavior. If your pet begins to show signs of discomfort or nervousness (e.g., barking or whining) administer verbal correction from a distance. As the training continues, gradually increase the duration of stays inside the kennel until the pet has become completely comfortable with their new surroundings. Providing play things for your pet companion will also comfort them. Also, insure that clean and adequate water and food is available at all times.

REMEMBER, verbal and physical affection will aid your pet companion to be completely satisfied with their new safety enclosure.

EXTRÊMEMENT IMPORTANT !

Les animaux de compagnie sont très confortables dans leur enclos de sécurité : toutefois, nous vous suggérons une brève période d'acclimatation de votre animal. Pour débuter ce processus, placez votre animal dans le chenil durant de courtes périodes (10 à 20 minutes) durant la journée lorsque vous êtes en mesure d'observer son comportement. Si votre animal commence à montrer des signes d'inconfort ou de nervosité (ex. jappement ou plainte), corrigez-le verbalement, à distance. Au fur et à mesure que l'entraînement se poursuit, augmentez graduellement la durée des séjours dans le chenil jusqu'à ce que l'animal soit totalement confortable dans son nouvel environnement. Offrir des jouets à votre animal le reconfortera davantage. De plus, assurez-vous que de l'eau propre et des aliments sont à portée de l'animal en tout temps.

N'OUBLIEZ PAS, les marques d'affection verbales et physiques aideront votre animal à se sentir totalement à l'aise dans son nouvel enclos de sécurité.

MUY IMPORTANTE!

Las mascotas son muy cómodo en el recinto de seguridad: sin embargo, se sugiere que haya un período breve introducción a acclamate su mascota. Para comenzar este proceso, el lugar de su mascota en la perrera por períodos cortos de tiempo (10-20 minutos) durante todo el día mientras usted es capaz de observar su comportamiento. Si su mascota empieza a mostrar signos de malestar o nerviosismo (por ejemplo, ladridos o silbidos) administrar corrección verbal a distancia. Como la formación continua, aumentar gradualmente la duración de las estancias dentro de la jaula hasta que la mascota se ha convertido en completamente cómodo con su nuevo entorno. Desempeñar aportando cosas para su mascota ayudará a consolarlos. También aseguran que la limpieza y adecuada agua y los alimentos están disponibles en todo momento.

RECUERDE, verbales y físicas de afecto, ayuda a tu mascota compañero esté completamente satisfecho con su nuevo recinto de seguridad.

LIMITED EXPRESS WARRANTY

Jewett-Cameron Company warrants your product to be free of defects in workmanship and further warrants that under normal use will be free of problems for one full year from date of purchase by original purchaser. **JEWETT-CAMERON COMPANY WILL NOT HAVE OTHER OR GREATER LIABILITY FOR DEFECTS, NOR WILL JEWETT-CAMERON COMPANY HAVE ANY LIABILITIES FOR INCIDENTAL OR CONSEQUENTIAL DAMAGES.** Some states do not allow the exclusion or limitation of incidental or consequential damages, so the above limitation or exclusion may not apply to you. If you discover a defect in the product during the warranty period and wish to obtain replacement parts or have questions, send notice of claim to: **Jewett-Cameron Company • PO Box 1010 • North Plains, Oregon 97133**

Include your return address, a copy of the original invoice or proof of purchase date, plus a description of claimed defect. All implied warranties of merchantability and fitness for particular purpose are limited to a duration of one (1) year from date of purchase. Some states do not allow limitations on how long an implied warranty may last, so the above limitations may not apply to you. This warranty gives you specific legal rights and you may also have other rights, which may vary from state to state.

GARANTIE EXPRESSE LIMITÉE

Jewett-Cameron Company garantit que votre produit exempt de tout défaut de fabrication et qu'il ne vous causera aucun problème pendant une période de un an à compter de la date de l'achat par l'acheteur initial s'il est utilisé dans des conditions normales. **JEWETT-CAMERON COMPANY N'ASSUME AUCUNE RESPONSABILITÉ AUTRE OU ACCRUE RELATIVEMENT AUX DÉFAUTS ET N'EST PAS RESPONSABLE DES DOMMAGES ACCESSOIRES OU CONSÉCUTIFS.** Certains États ou certaines provinces ne permettent pas l'exclusion ou la limitation des dommages accessoires ou consécutifs, de sorte que les exclusions ou les limitations mentionnées ci-dessus peuvent ne pas s'appliquer à vous. Si votre produit présente un défaut au cours de la période de la garantie et que vous souhaitez obtenir des pièces de rechange ou que vous avez des questions, envoyez une réclamation à l'adresse suivante : **Jewett-Cameron Company • PO Box 1010 • North Plains, Oregon 97133 États-Unis** Veuillez inclure votre adresse, une copie de la facture originale ou une autre pièce prouvant la date d'achat, ainsi qu'une description du défaut. Toute garantie implicite de qualité marchande ou d'adéquation à un usage particulier est limitée à une durée de un (1) an à compter de la date d'achat. Certains États ou certaines provinces ne permettent pas de limitations quant à la durée des garanties implicites, de sorte que les limitations indiquées ci-dessus peuvent ne pas s'appliquer à vous. Cette garantie vous confère des droits précis. Il est possible que vous disposiez également d'autres droits, qui varient d'un État ou d'une province à l'autre.

GARANTÍA EXPLÍCITA LIMITADA

Jewett-Cameron Company garantiza que la producto no presentará defectos en la mano de obra y que en condiciones de uso normal garantiza que no tendrá problemas durante un período de un año **JEWETT-CAMERON COMPANY NO SERÁ RESPONSABLE DE LOS DEFECTOS NI DAÑOS INCIDENTALES O RESULTANTES.** Algunos estados no permiten la exclusión o limitación de los daños accidentales o resultantes, de modo que la exclusión o limitación anterior tal vez no se aplica a su caso. Si descubre defectos en el producto durante el periodo de vigencia de la garantía y desea obtener piezas de repuesto o tiene preguntas, envíe un aviso de reclamo a: **Jewett-Cameron Company • PO Box 1010 North Plains, Oregon 97133.** Incluya su dirección para devoluciones y una copia de la factura original o prueba de la fecha de compra además de una descripción del defecto que reclama. Todas las garantías implícitas de comerciabilidad e idoneidad para un fin en particular, se limitan en duración a (1) año a partir de la fecha de compra. Algunos estados no permiten limitaciones sobre la duración de una garantía implícita, de modo que las limitaciones antes descritas puede que no se apliquen en su caso. Esta garantía le otorga derechos legales específicos, pero podría tener también otros derechos que pueden variar según el estado.

KENNEL COVER & ROOF SYSTEM ASSEMBLY -If purchased separately or with your kennel
INSTALLATION DE COUVERTURE DE CHENIL - (Il peut être acheté séparément ou avec dog kennel)
CUBIERTA PARA CASILLA DE PERRO Y MONTAJE DEL TECHO - (se pueden comprar por separado o incluido con la casilla)

Item Number	Description	Part Qty						
		L1	L2	M	N	O1	O2	P
CL 00300	5'x5' kennel cover kit	2	2	0	2	1	1	10
CL 00301	5'x10' kennel cover kit	4	4	2	2	3	2	16
CL 00302	5'x15' kennel cover kit	4	4	2	2	3	3	20
CL 00303	10'x10' kennel cover kit	3	3	1	2	2	0	20
CL 00304	8'x6.5' kennel cover kit	3	3	1	2	2	0	14



Q (1)



Tools needed: Phillips screwdriver, Adjustable wrench
 Assembly time with 2 people: 30 minutes

Outils nécessaires: Tournevis cruciforme, Clé réglable
 Temps pour l'assemblage avec 2 personnes: 30 minutes

Herramientas Necesarias: Destornillador phillips, Llave ajustable
 El tiempo de la asamblea con 2 personas: 30 minutos

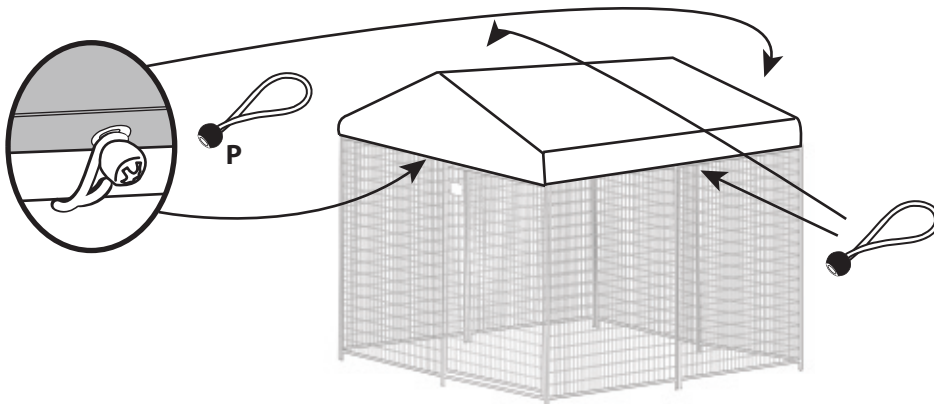
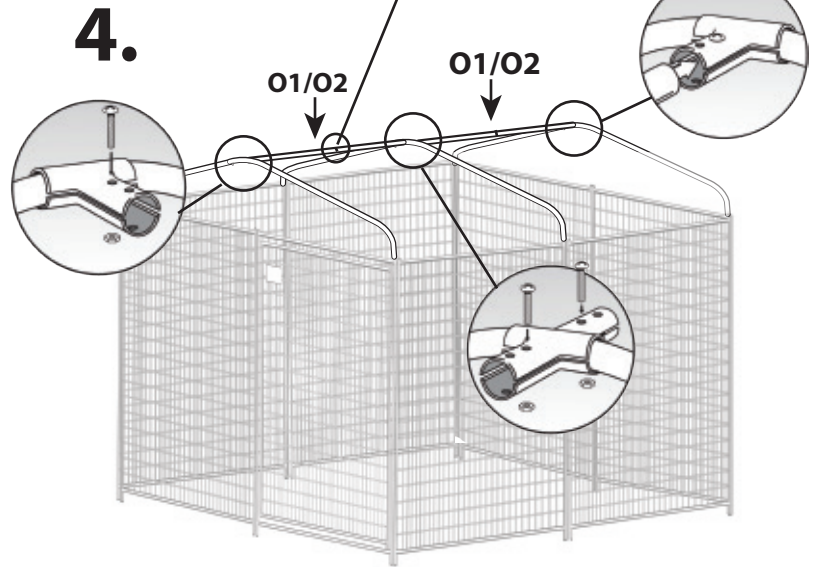
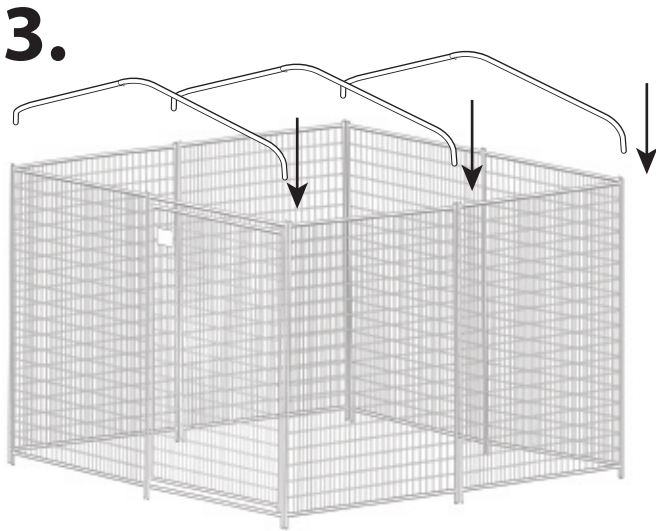
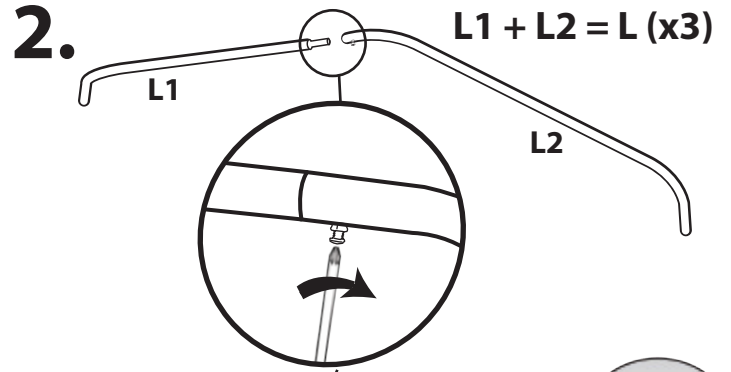

Ground Anchor

ANCHORING SYSTEM INSTALLATION - If purchased separately or included with kennel
INSTALLATION DE L'ANCRAGE - (peut avoir été acheté séparément ou avec le chenil)
INSTALACIÓN DE SISTEMA DE SUJECIÓN O ANCLAJE - (se pueden comprar por separado o incluido con la casilla)

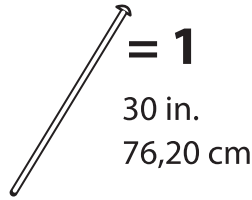
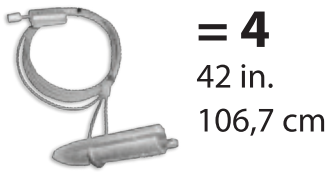

An excellent way to secure your dog kennel, greenhouse or shelter to the ground. Suitable for all soil conditions. No digging required.

Une façon excellente de protéger votre chenil de chien, serre ou abri à la terre. Convenable pour toutes les conditions de sol. Aucun bêchage exigé.

Una excelente manera de asegurar al suelo la casilla de su perro, el Invernadero o el refugio. Apto para todas las condiciones de suelo. No requiere excavación.

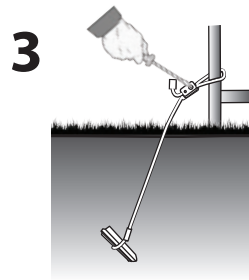
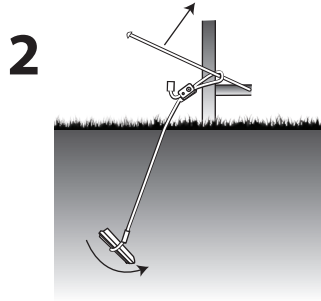
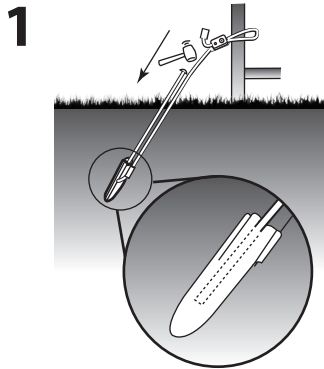

1. Drive anchor into ground

Conduisez l'ancre dans la terre

Ponga el ancla dentro de la tierra.

2. Pull up on cable to set anchor

Tirez en haut sur le câble pour mettre l'ancre

Tire del cable para fijar el ancla

3. Attach to kennel or item to be anchored

Faites partie du chenil ou de l'article à être ancré

Enganche a la casilla o al elemento a sujetar

WIND SCREEN / SHADE CLOTH INSTALLATION - If purchased separately or included with kennel
INSTALLATION DE TISSU D'OMBRE - (peut avoir été acheté séparément ou avec le chenil)
INSTALACIÓN DE MALLA DE SOMBRA - (se pueden comprar por separado o incluido con la casilla)



No tools needed

Assembly time with 2 people: 30 minutes or less

Aucun outils nécessaires

Temps pour l'assemblage avec 1 personne: 30 minutes ou moins

No se necesitan herramientas

El tiempo de la asamblea con 1 persona: 30 minutos o menos

