

Led Light Installation Guide

Lego 10253

Big Ben

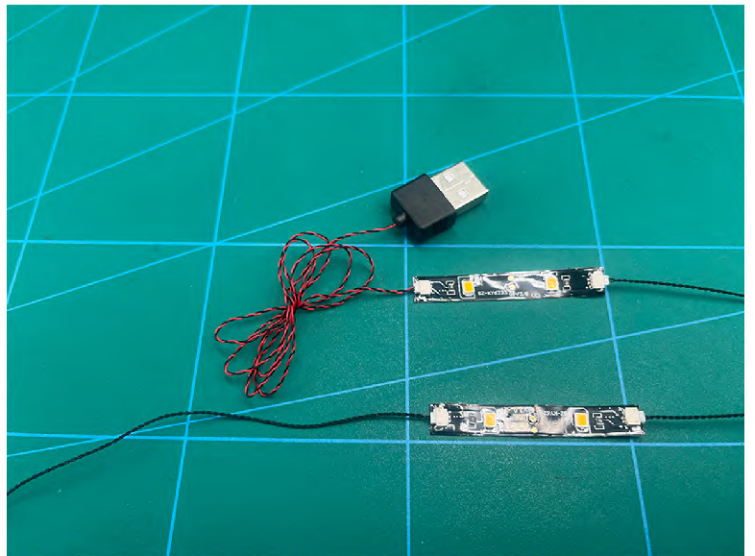

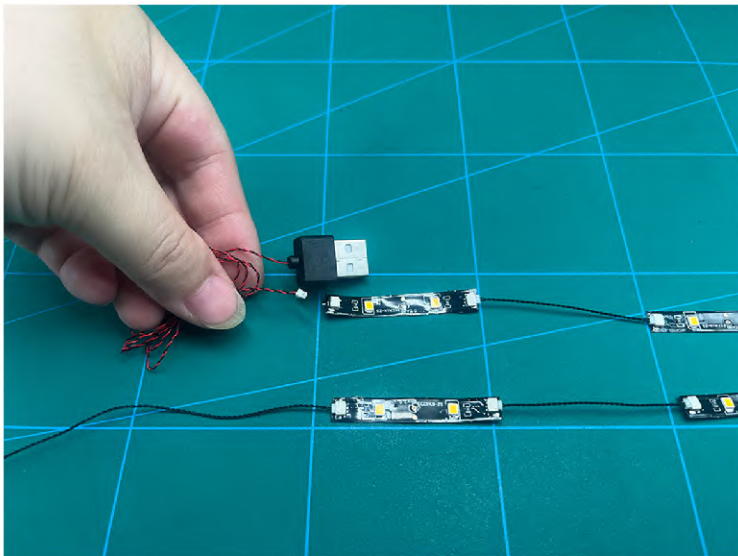
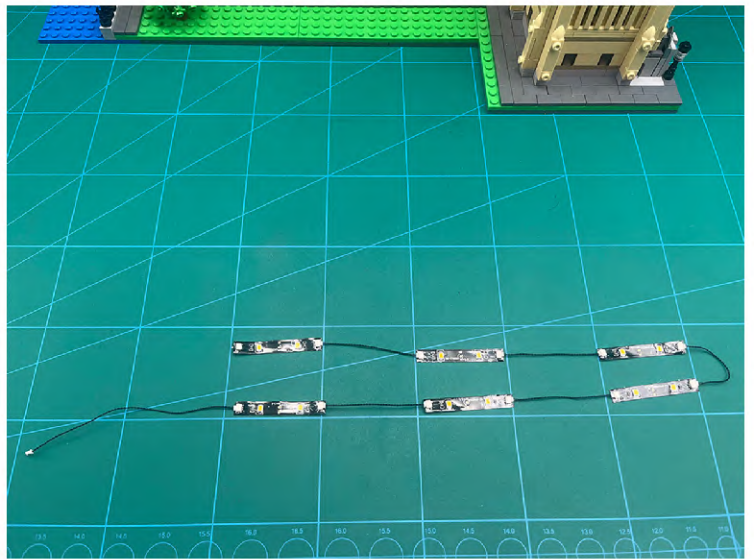
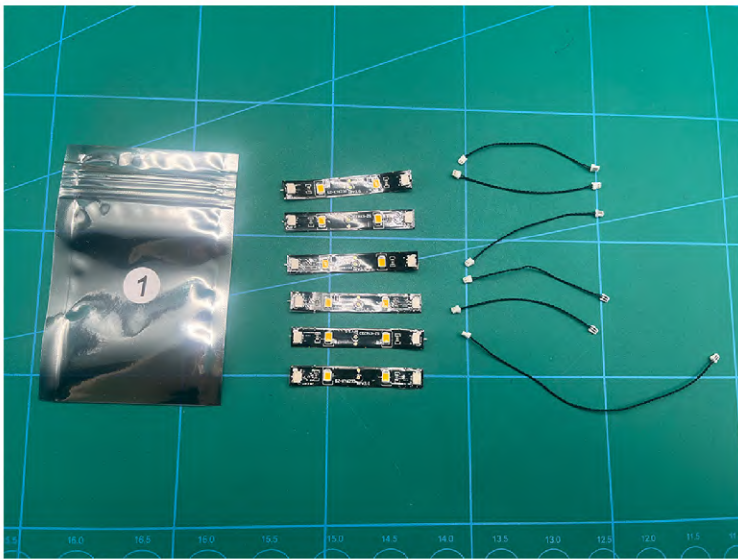
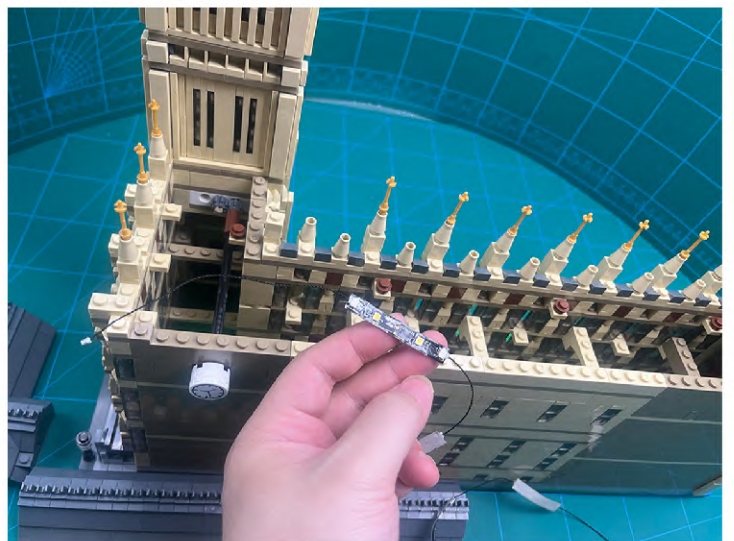
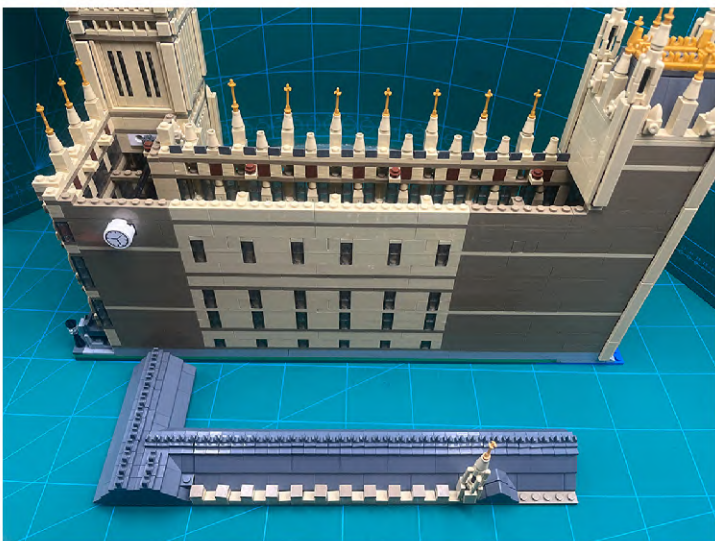
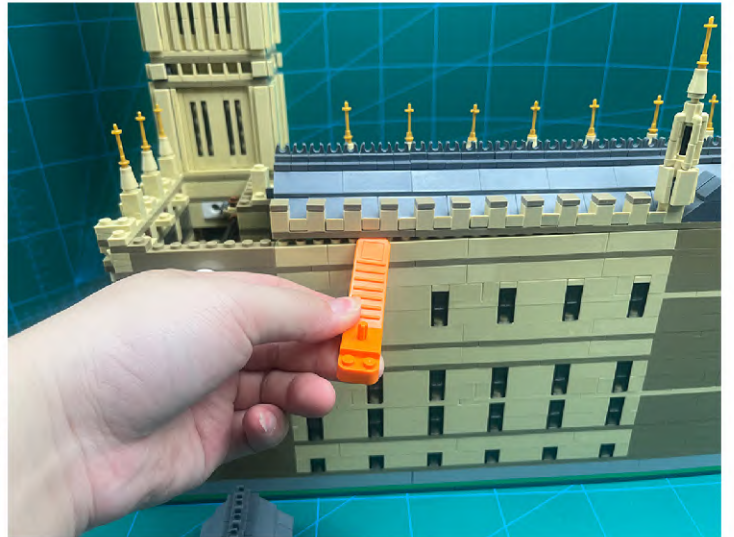
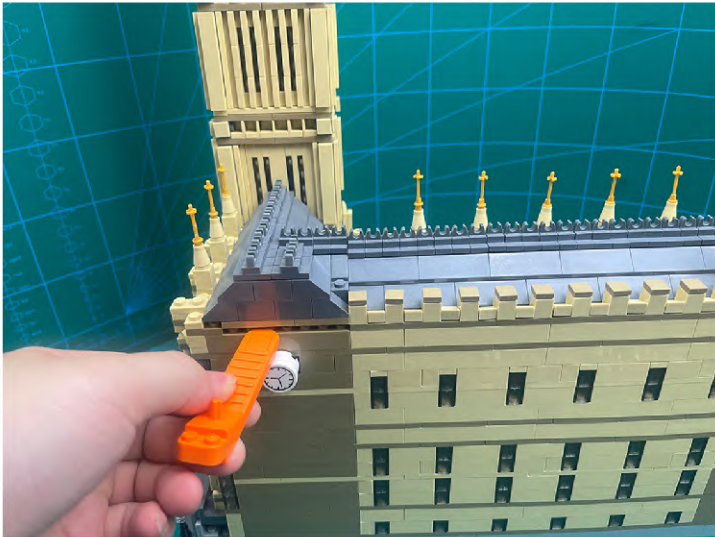
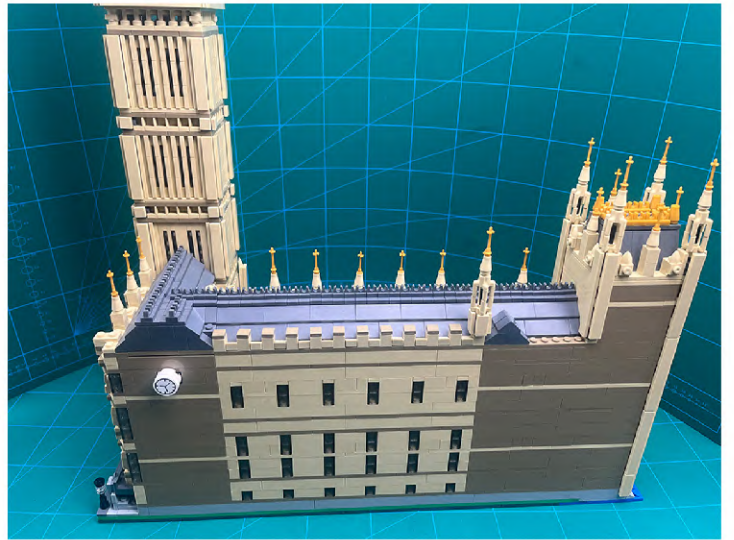

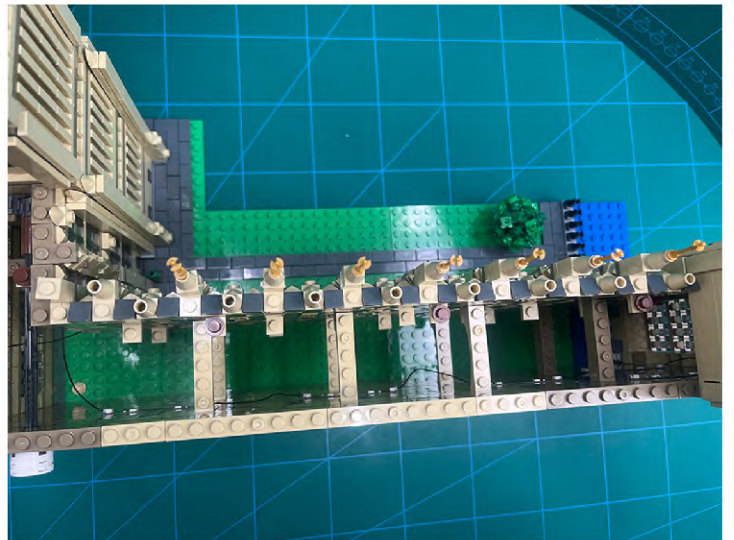
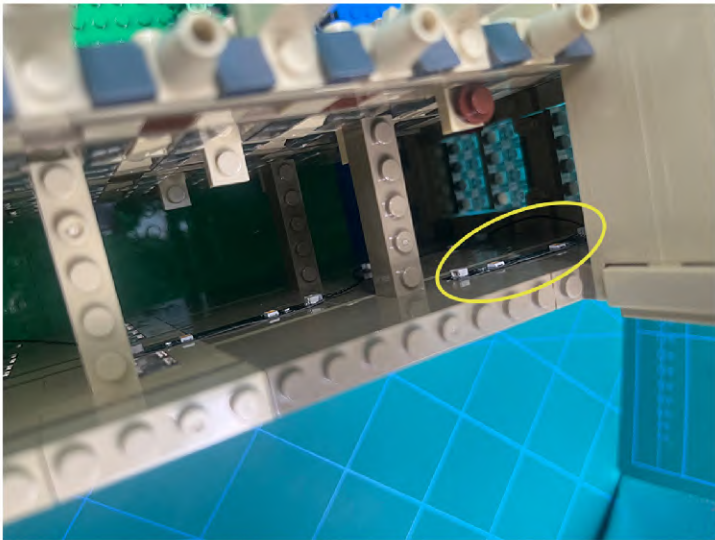
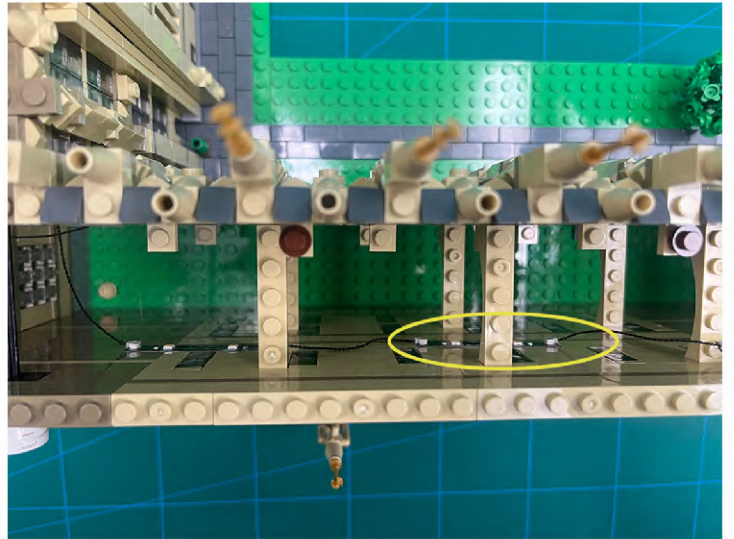
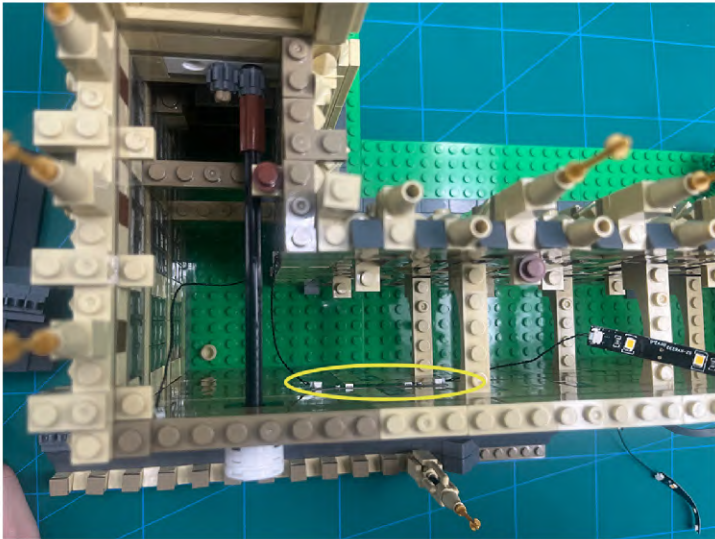
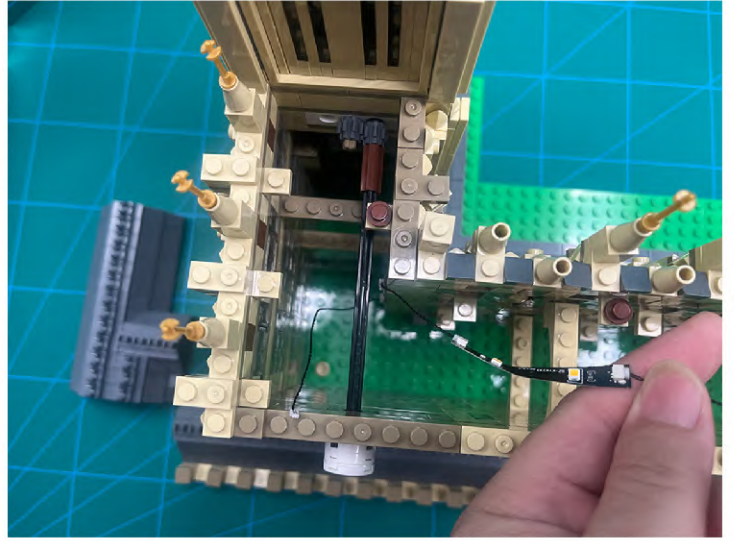
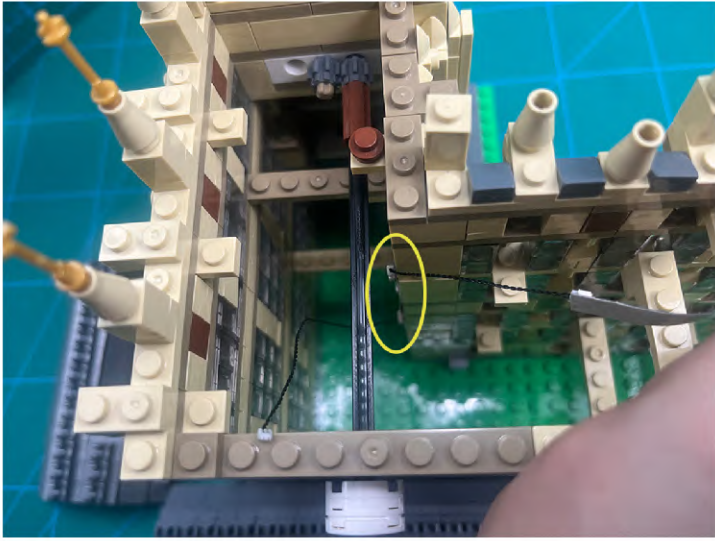

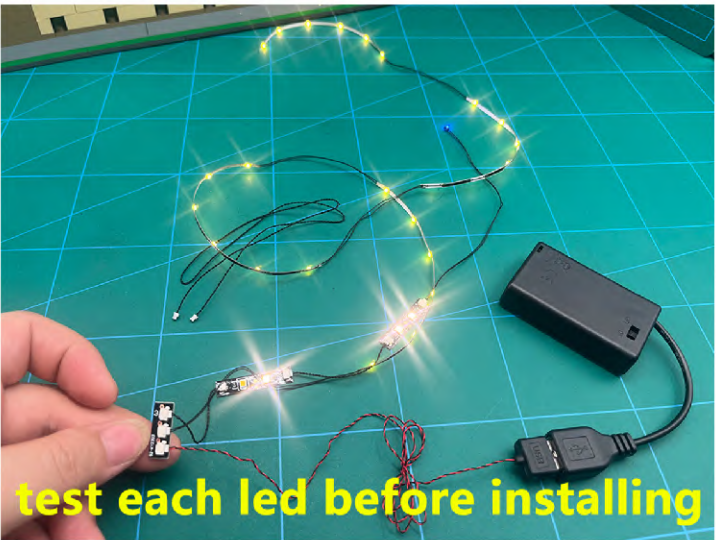
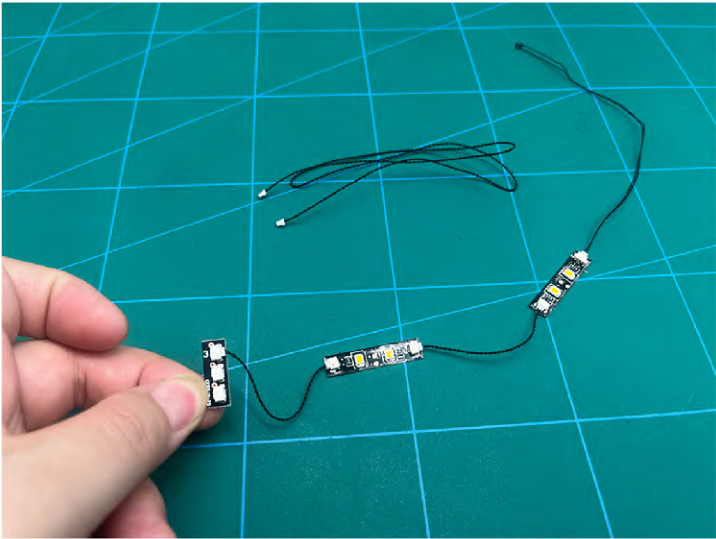
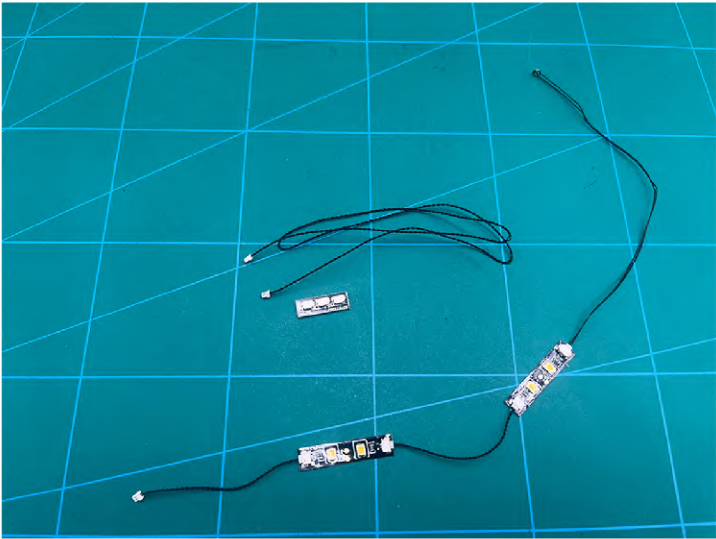
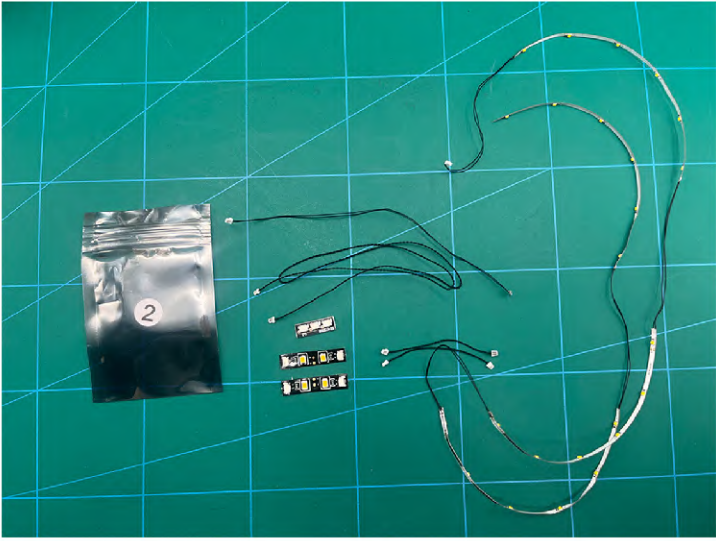
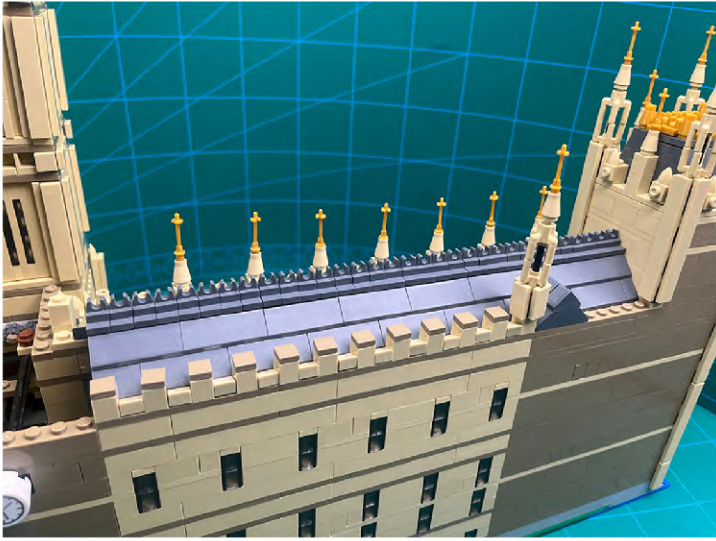

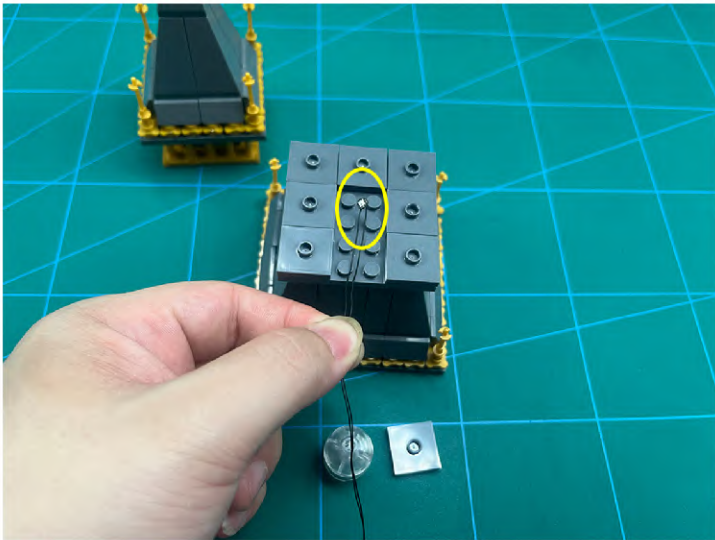
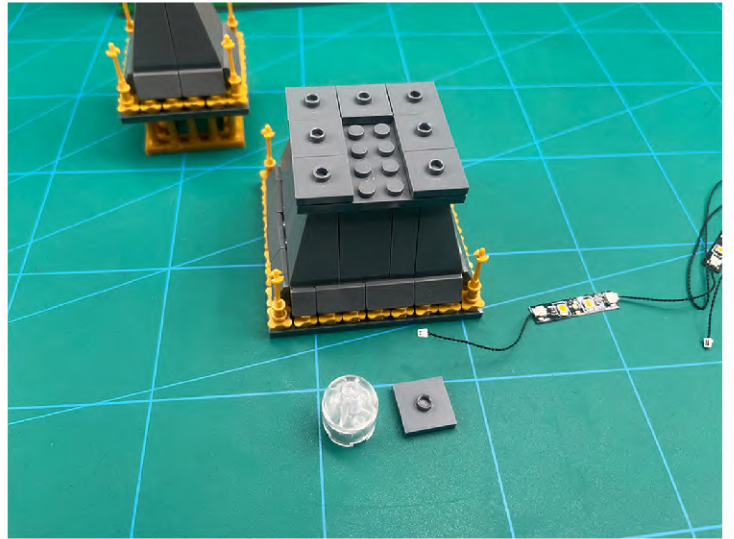
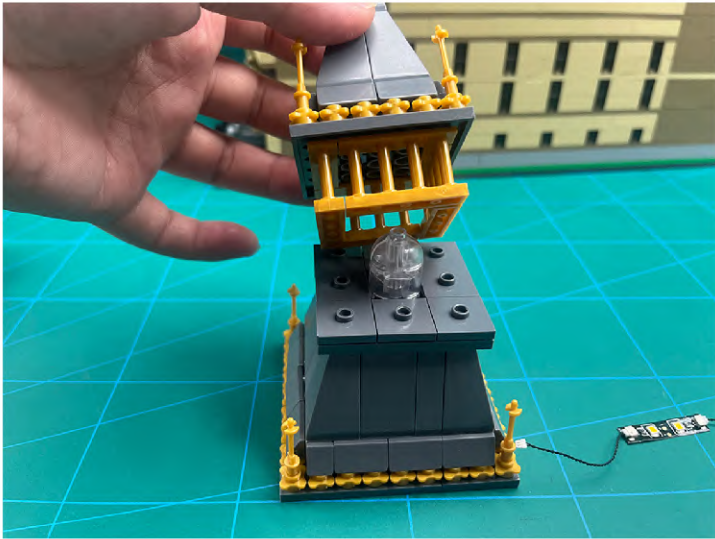
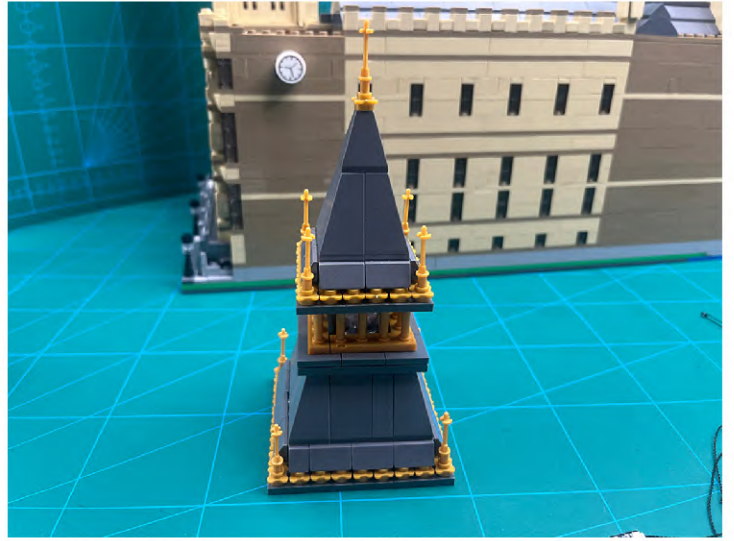

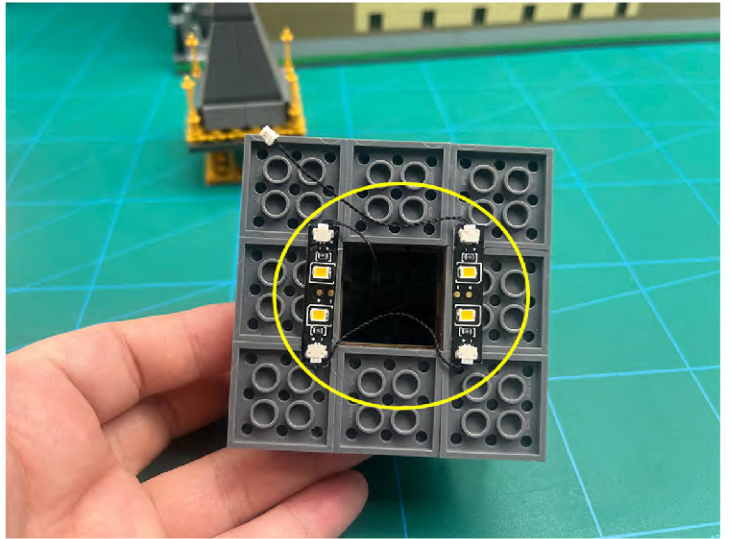
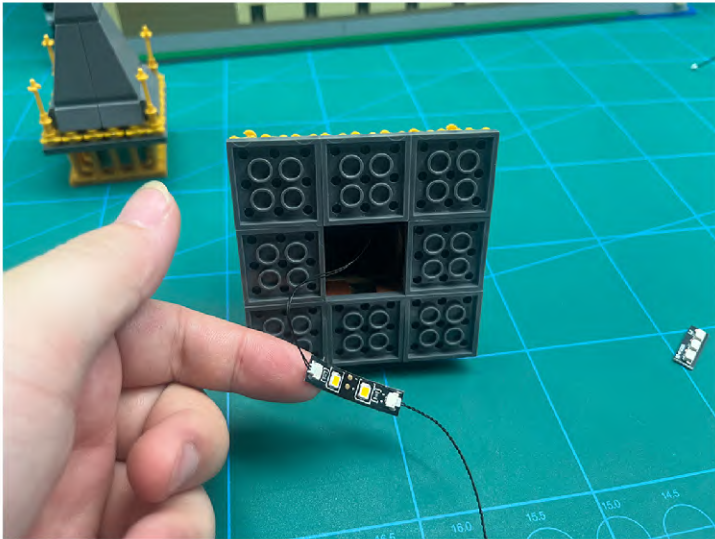
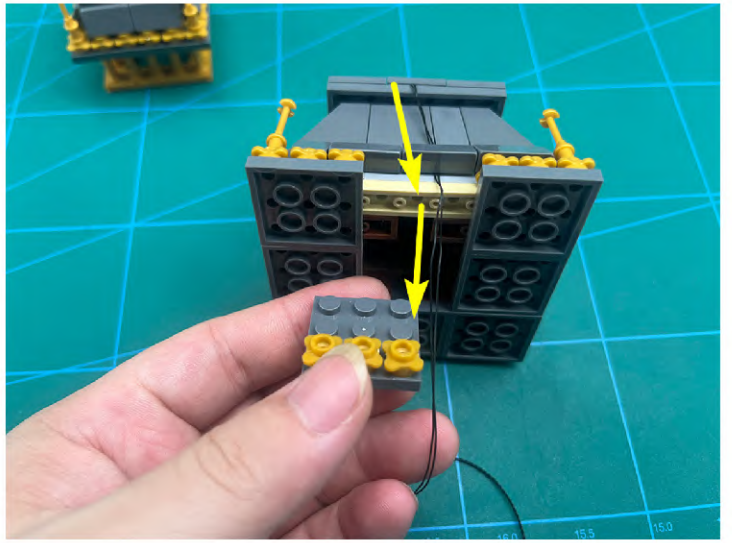
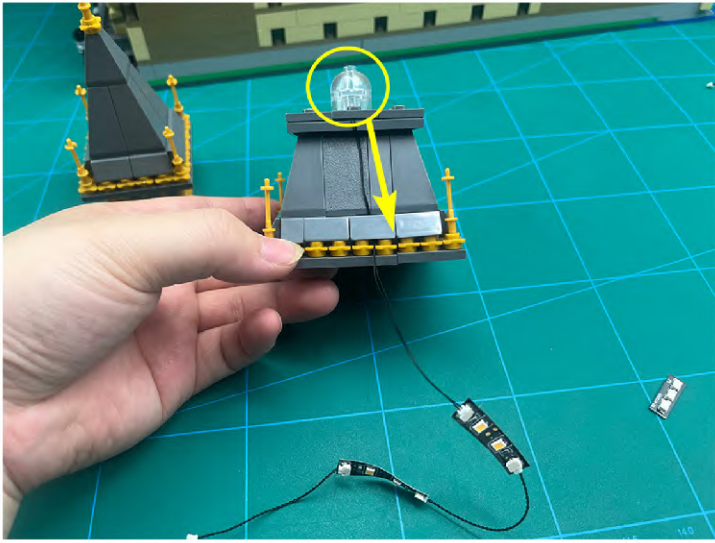

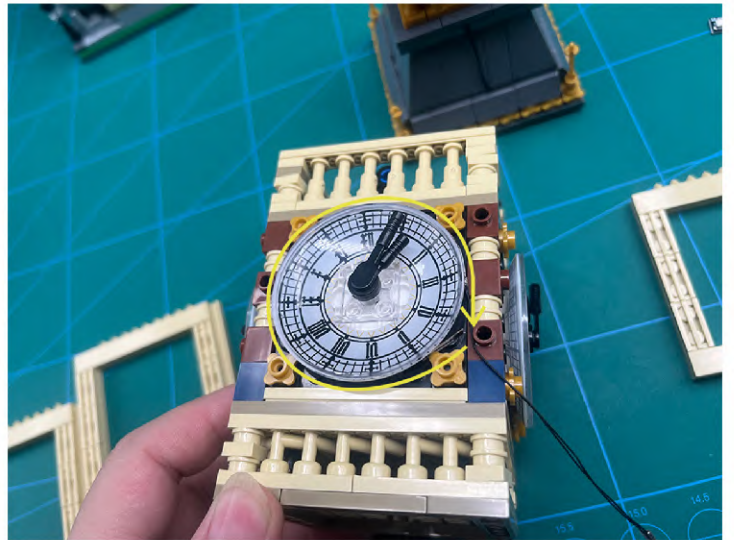
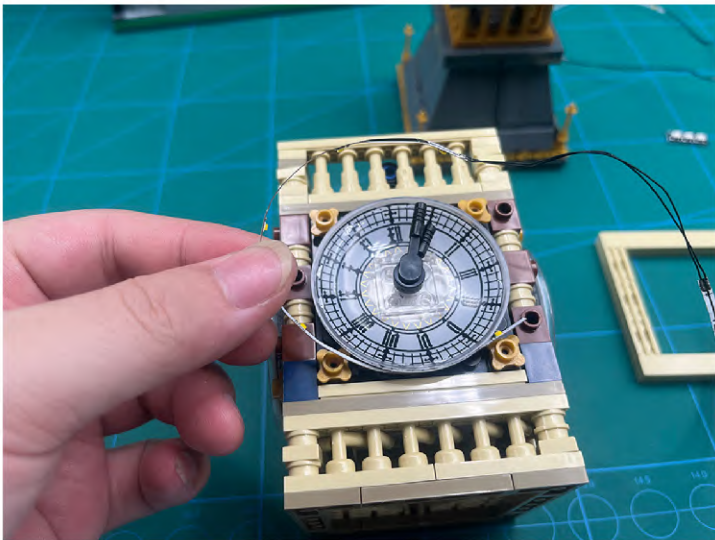
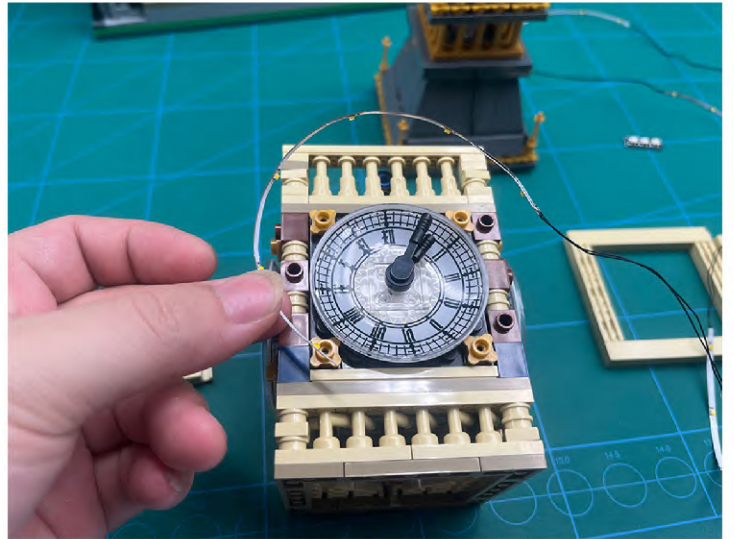
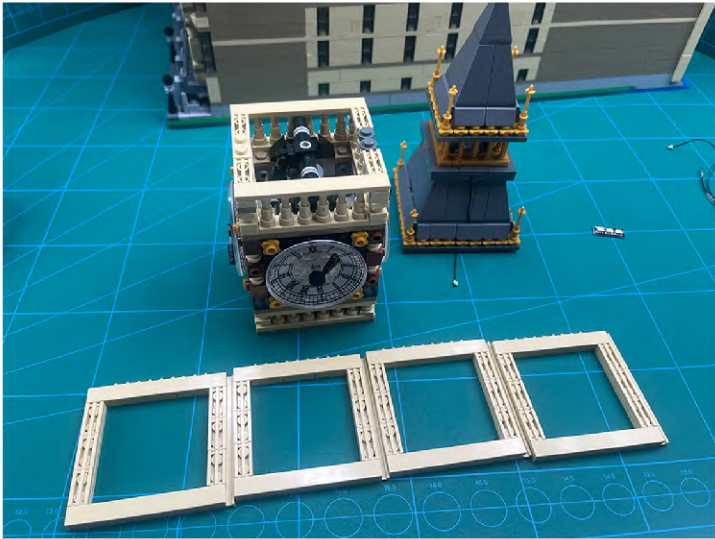
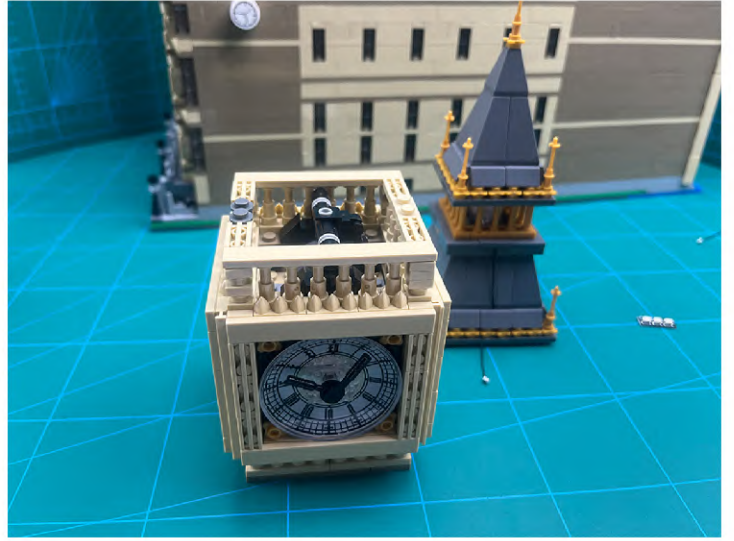
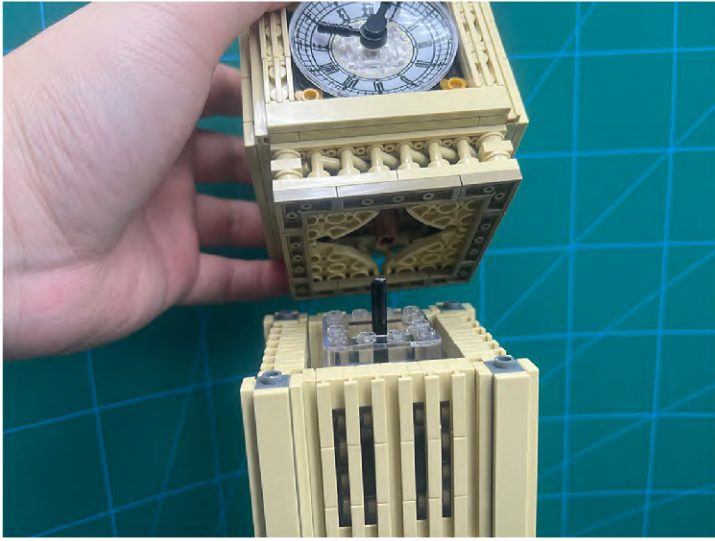

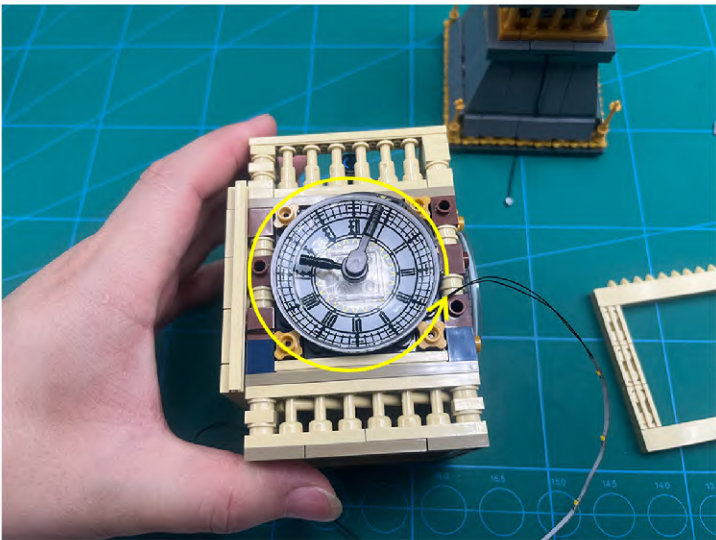
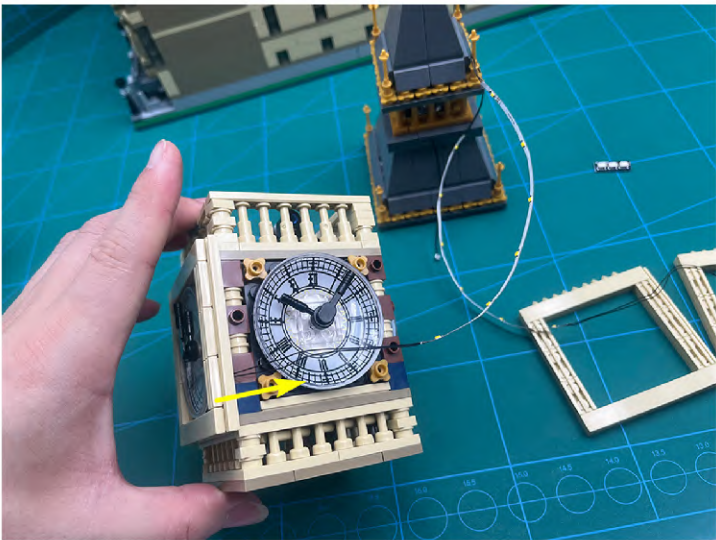
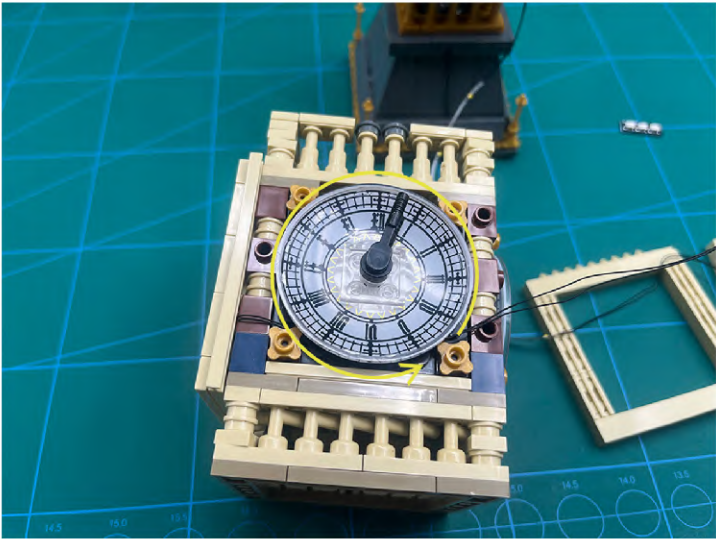
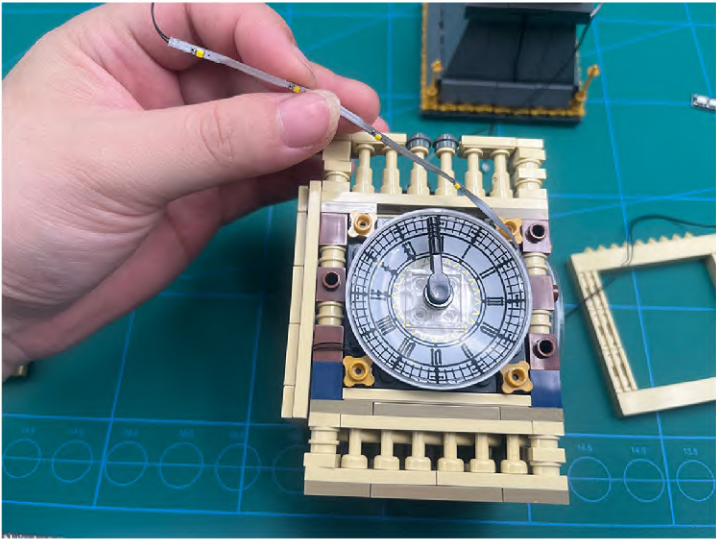
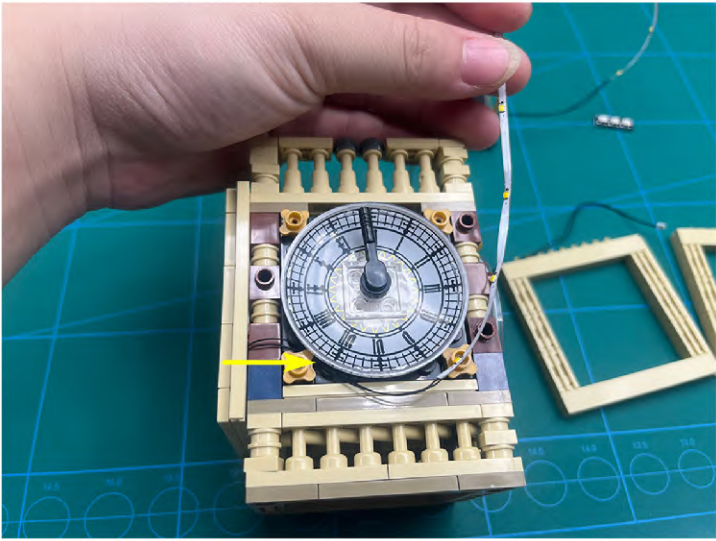
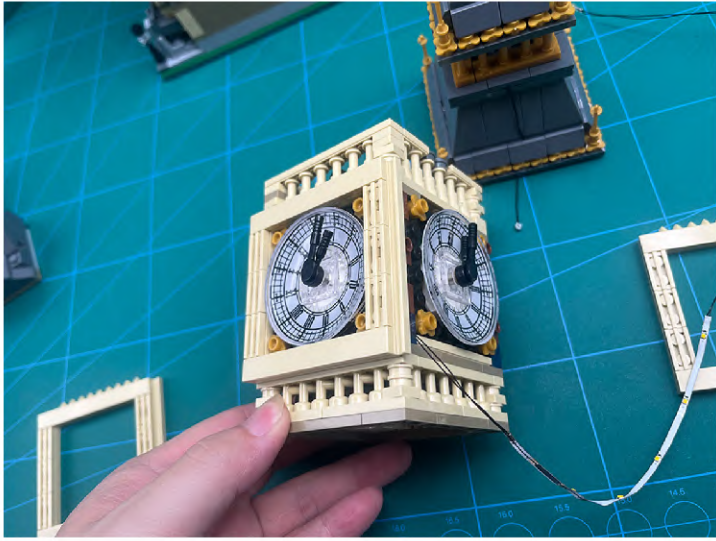

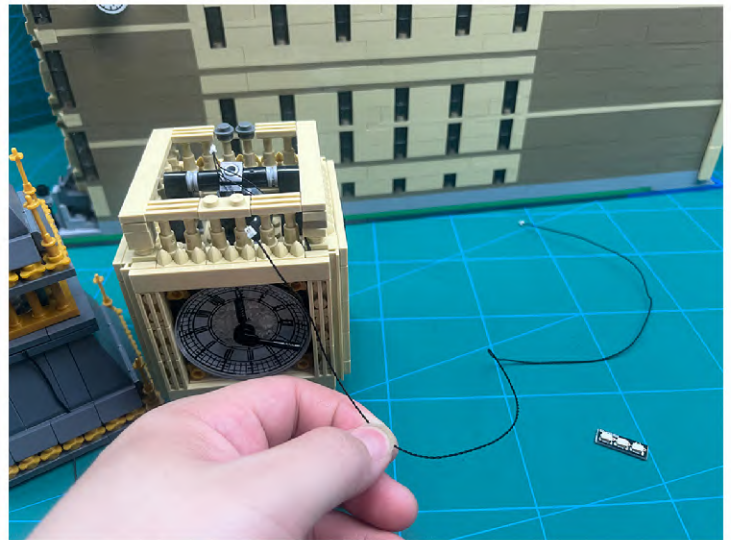
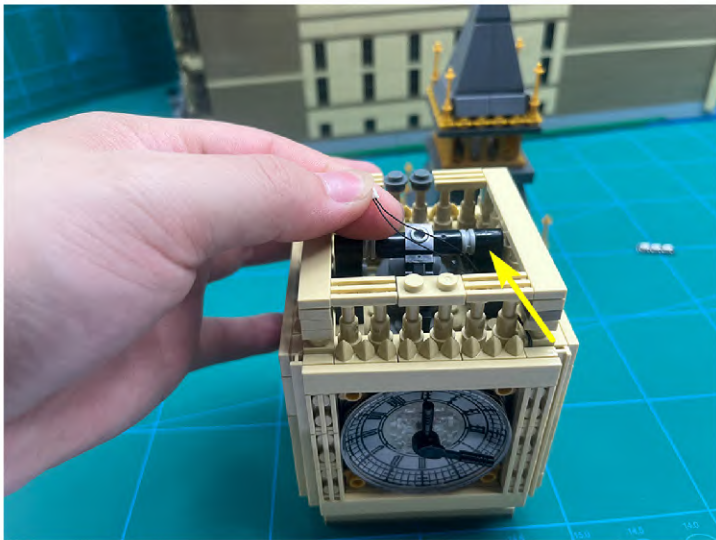
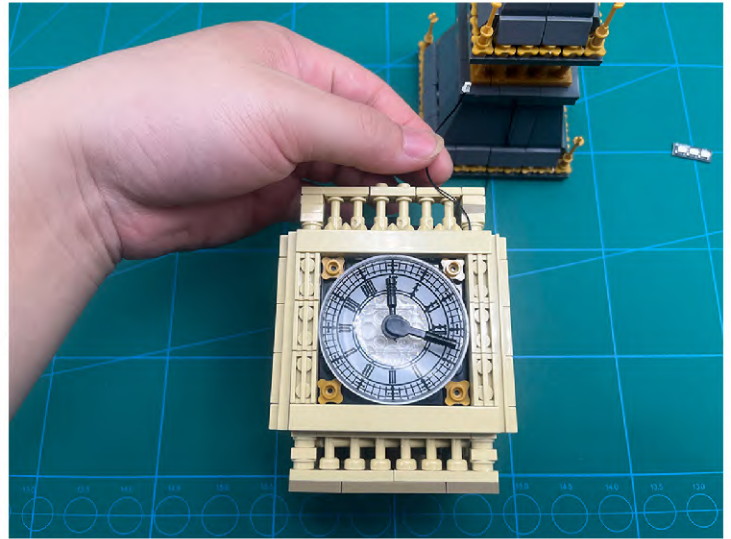
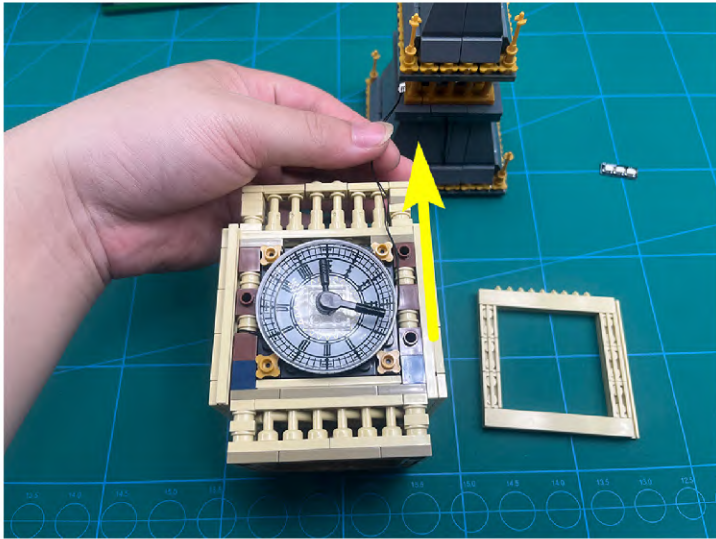
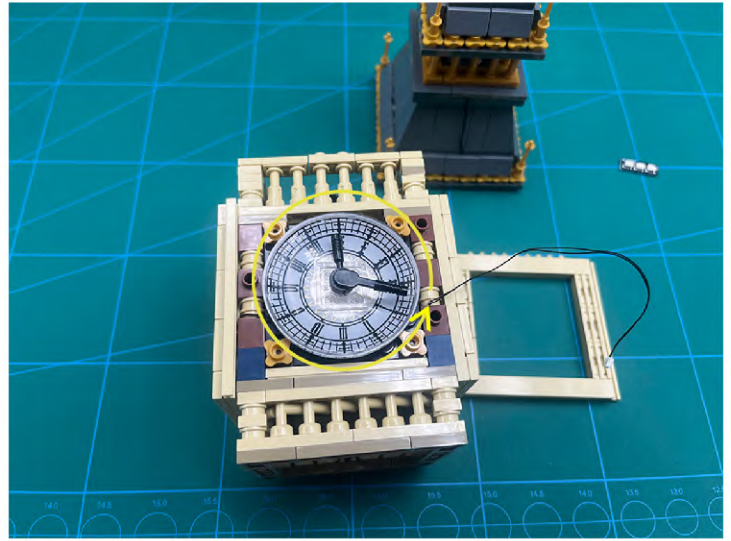
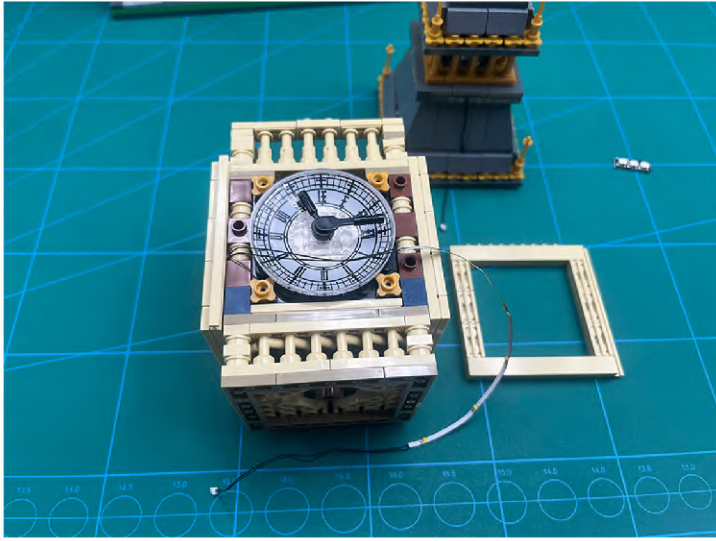

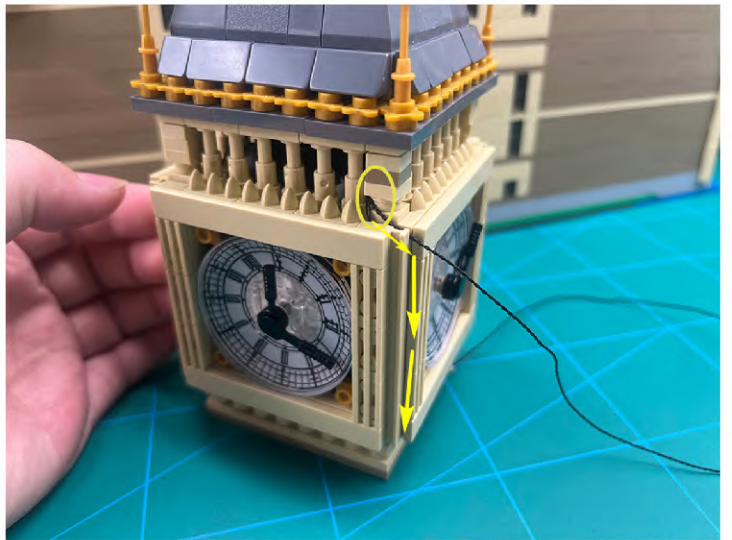
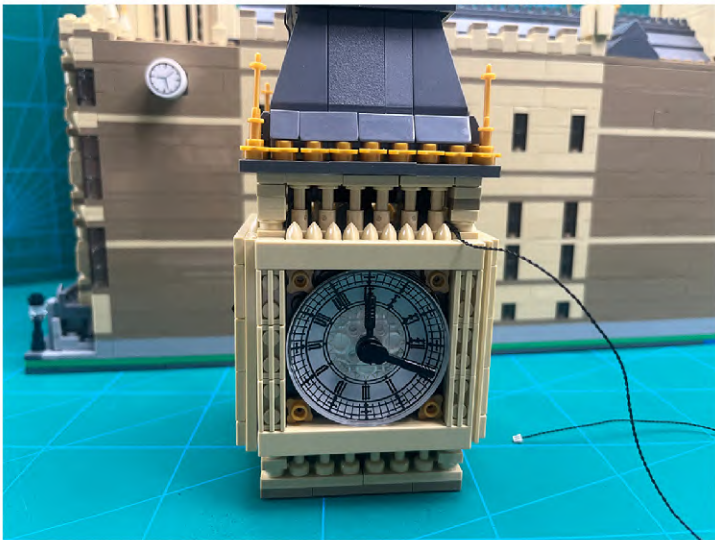
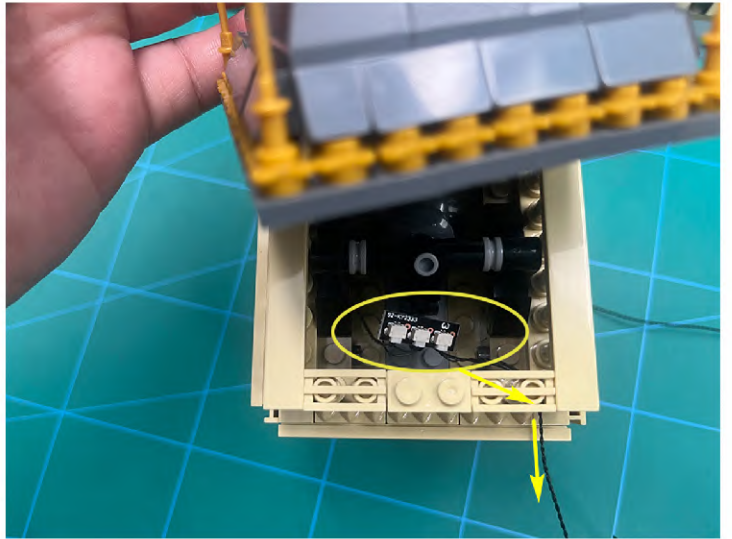
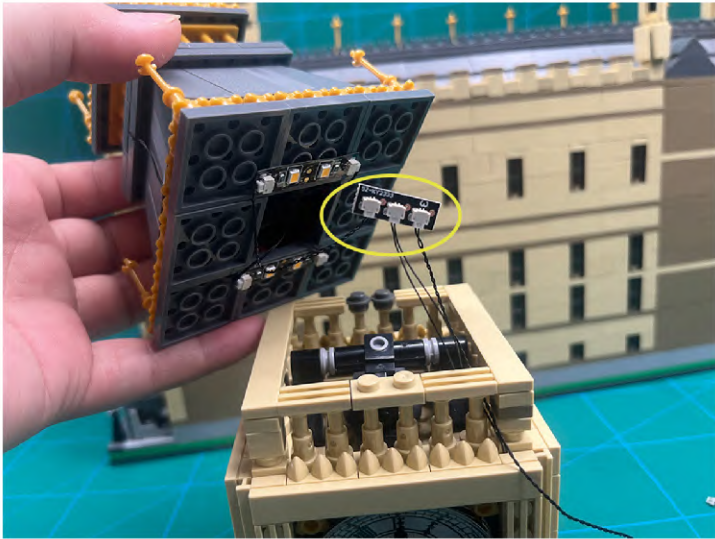
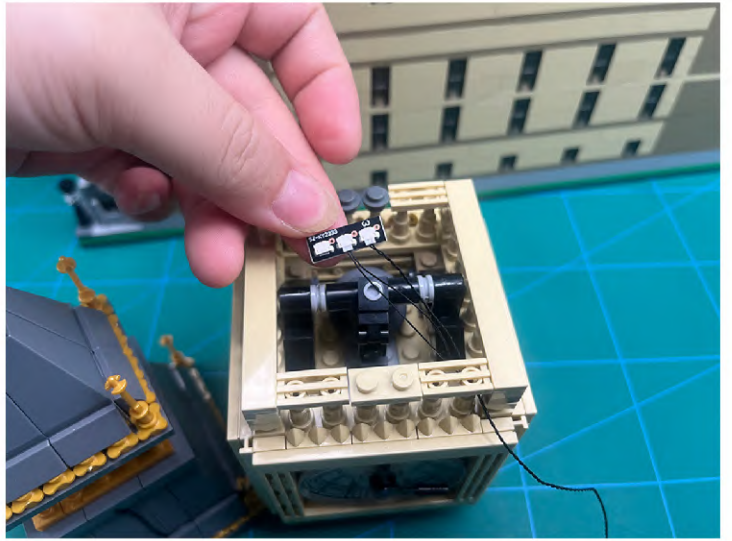
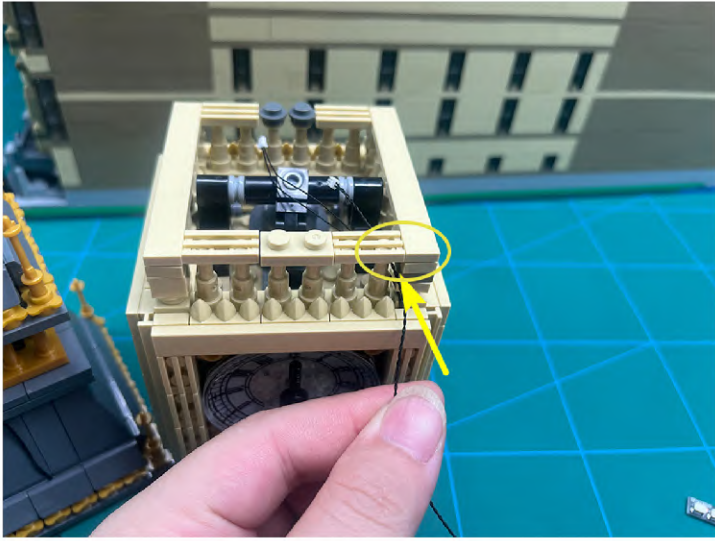

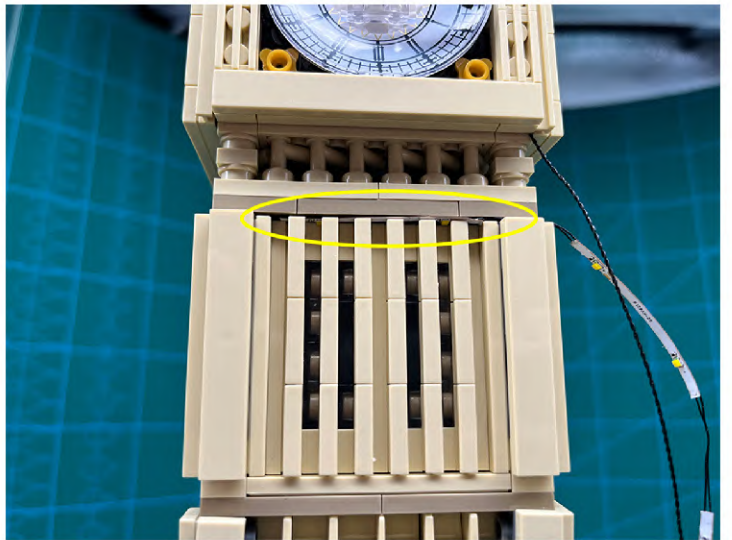
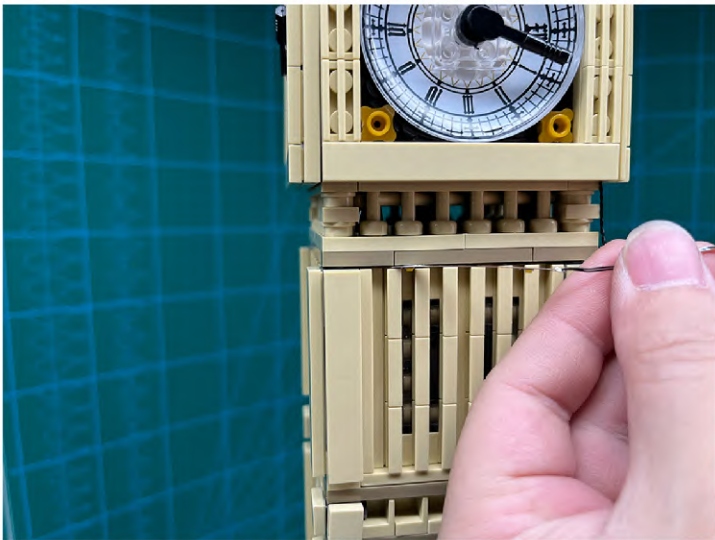
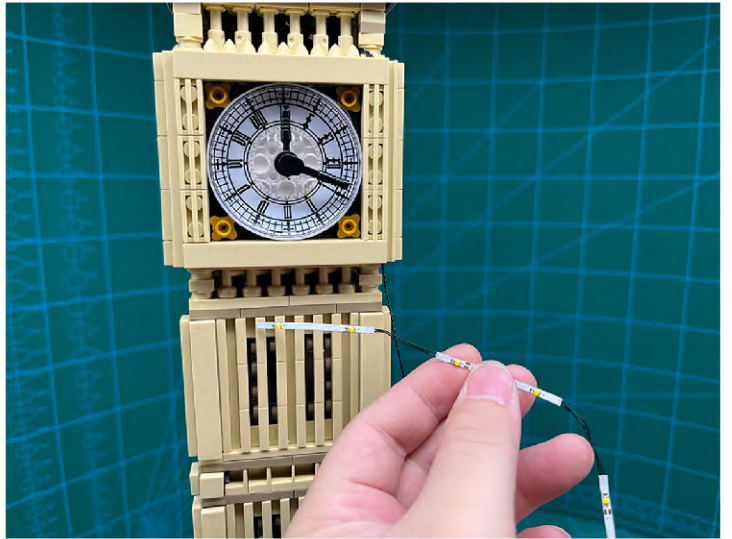
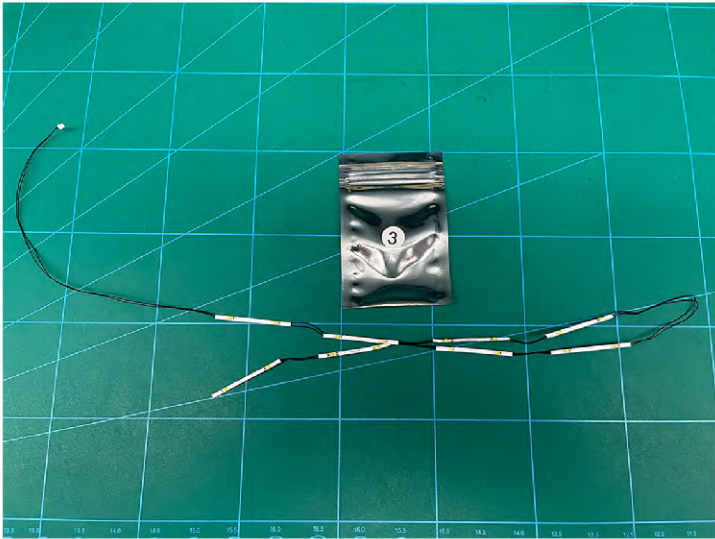
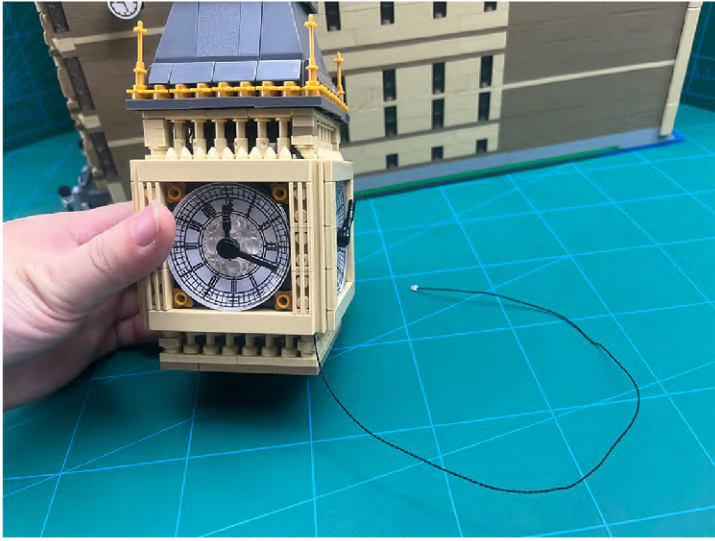

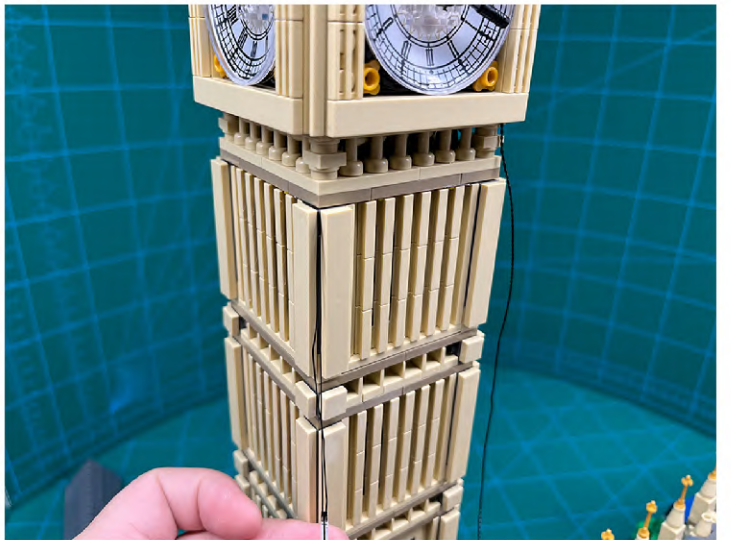
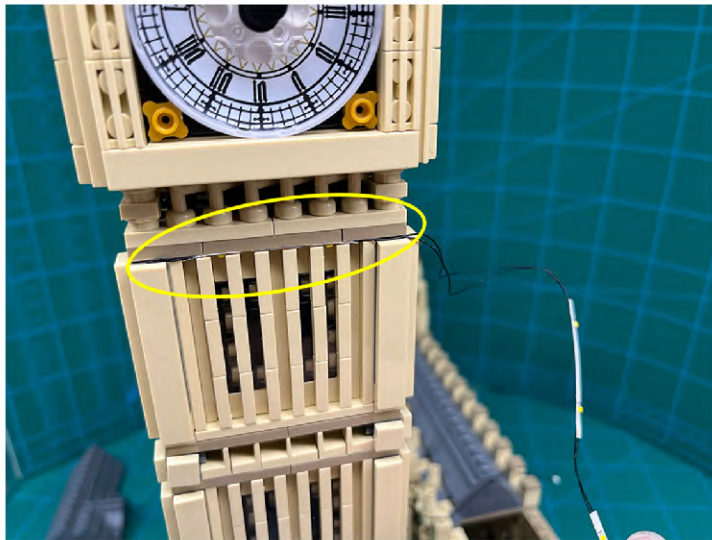
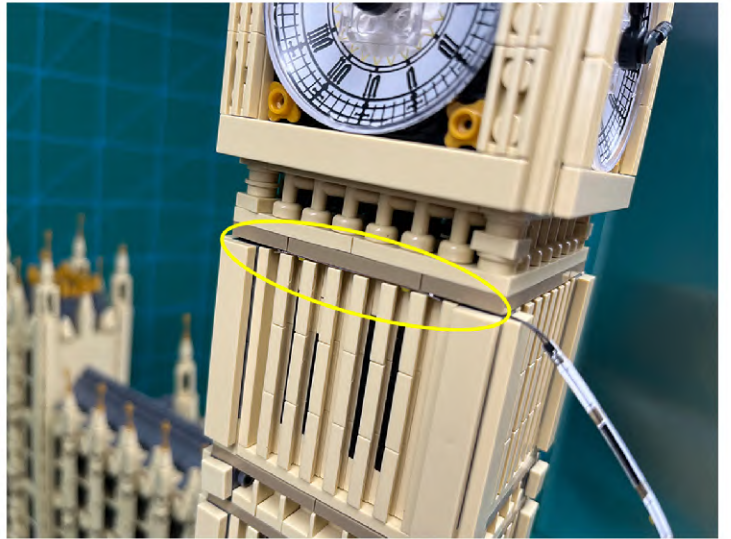
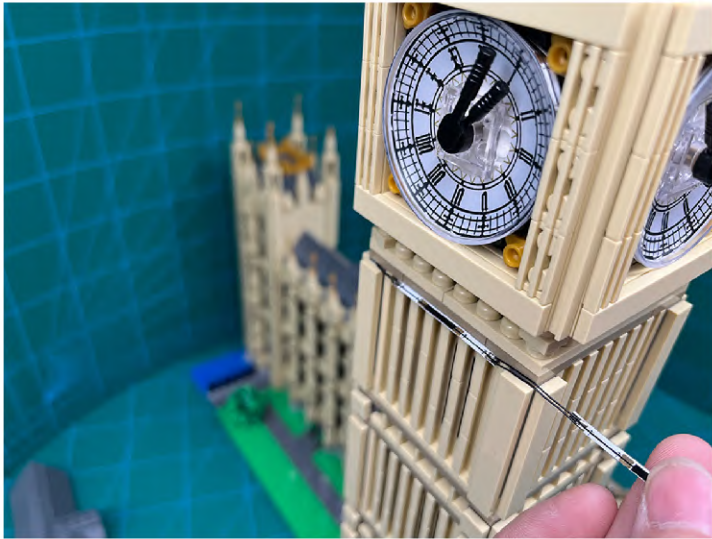
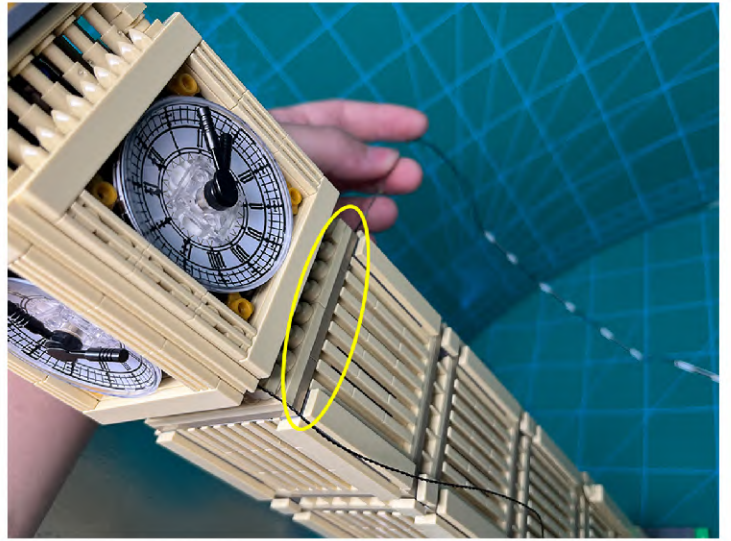
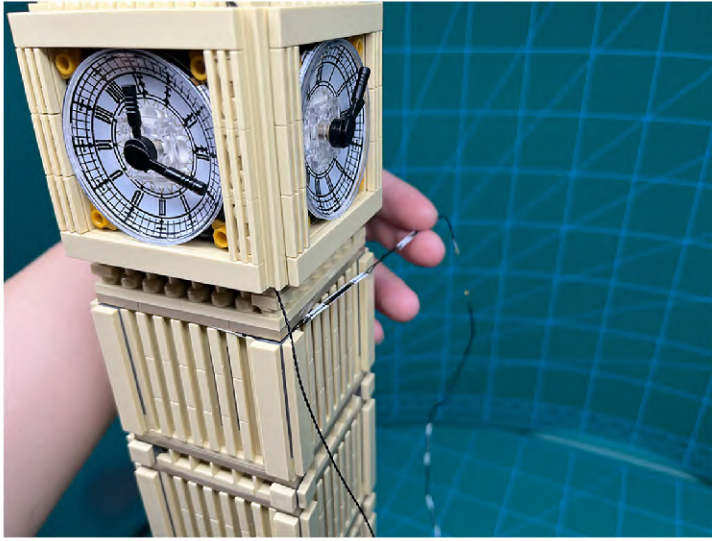

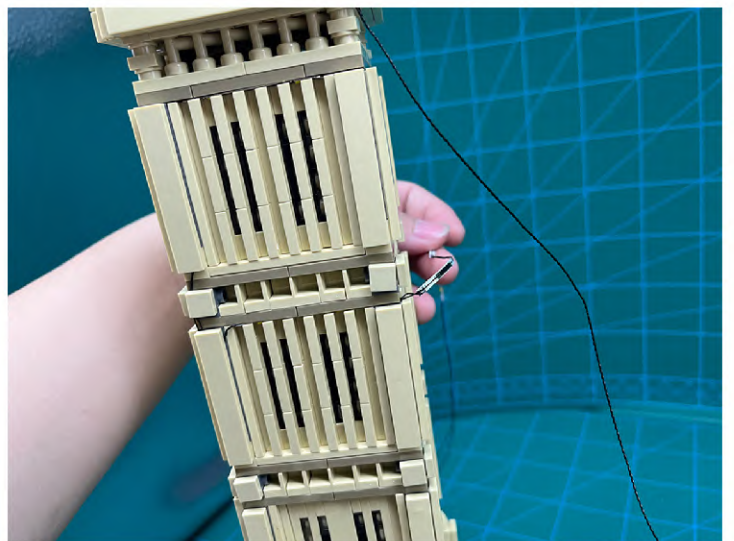
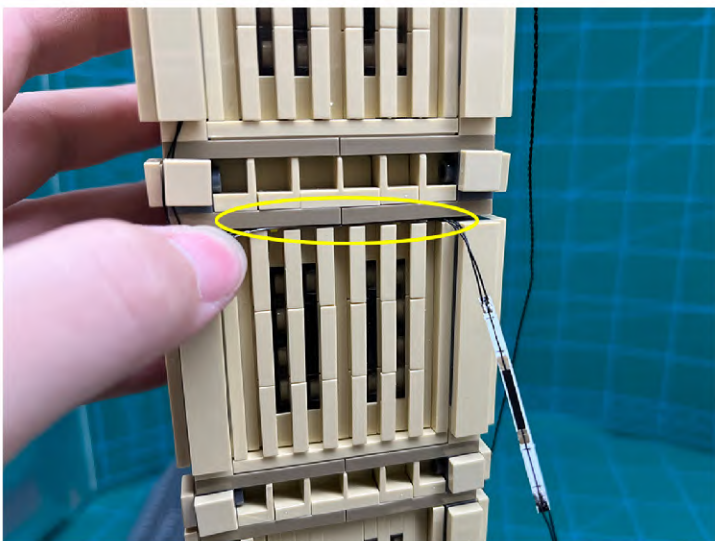
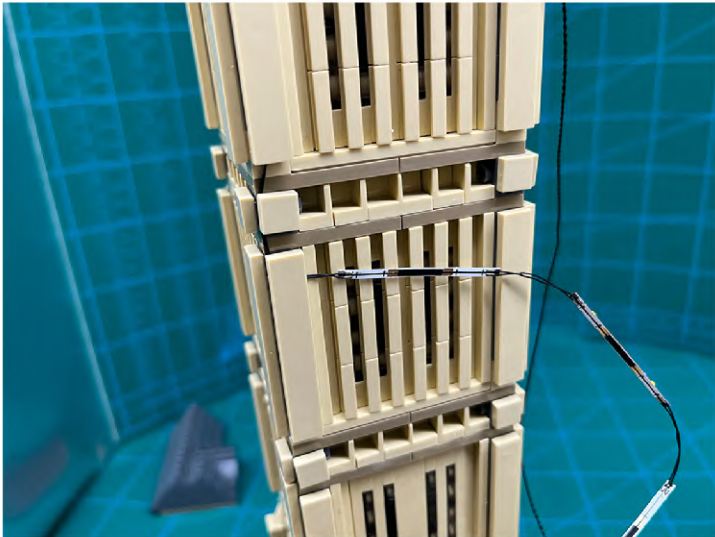
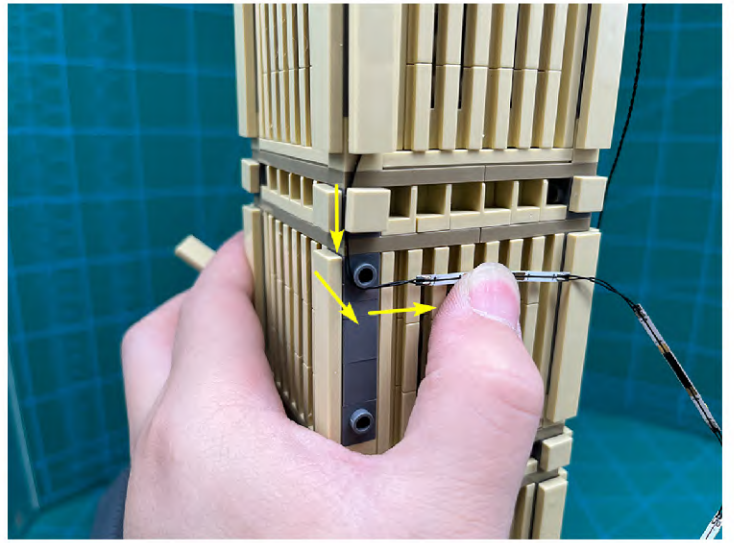
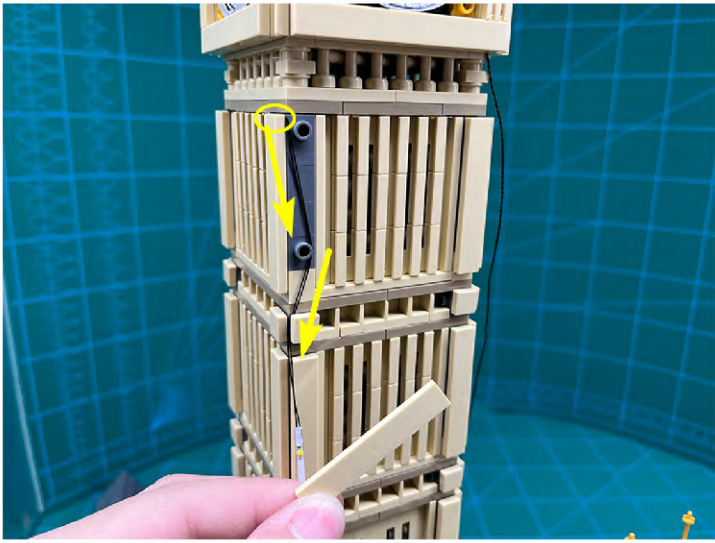

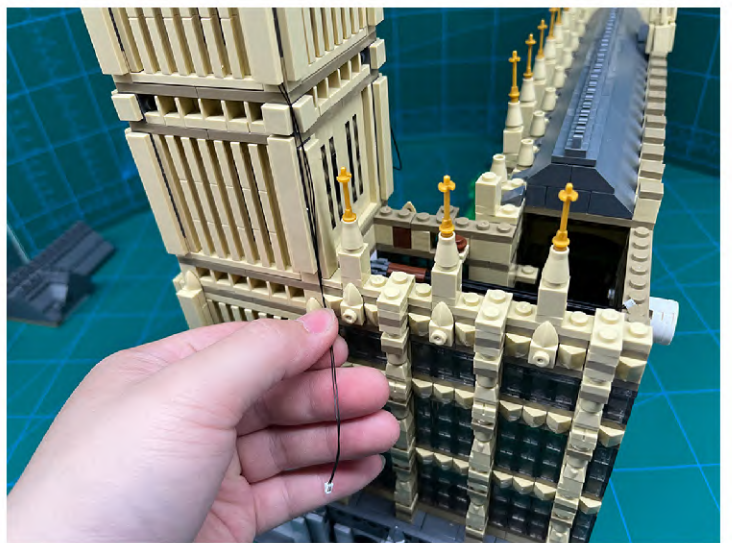
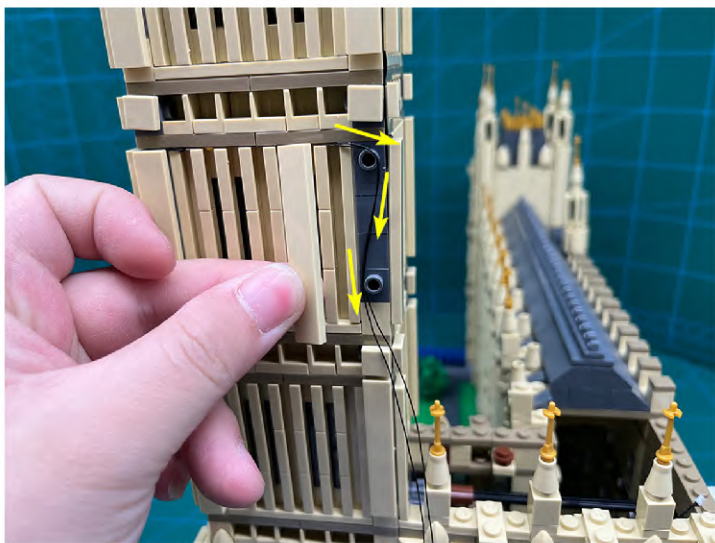
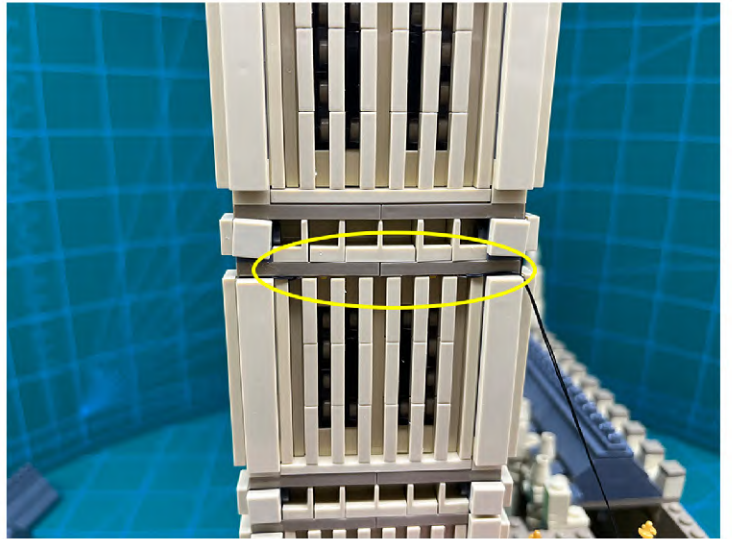
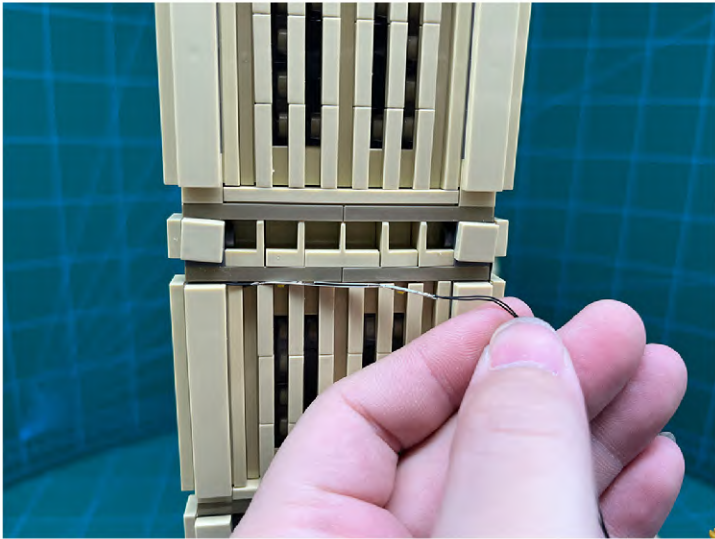
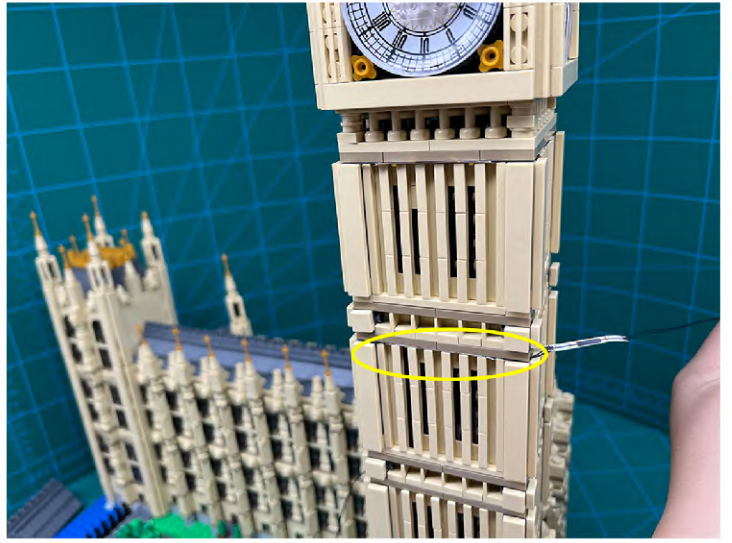
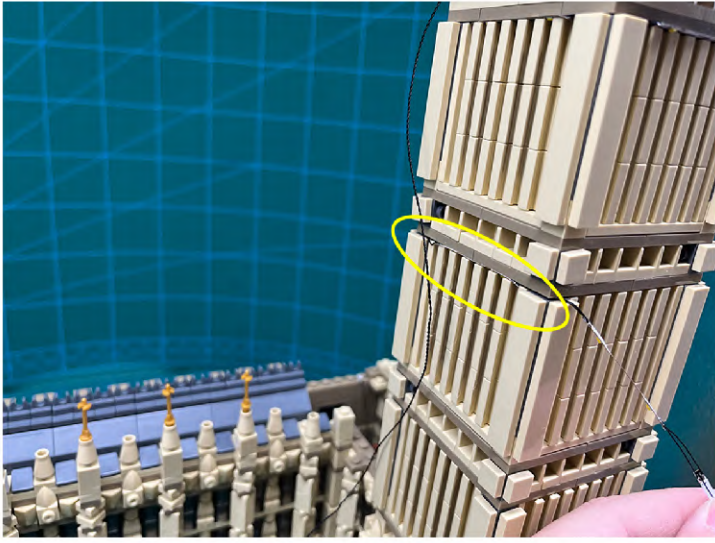

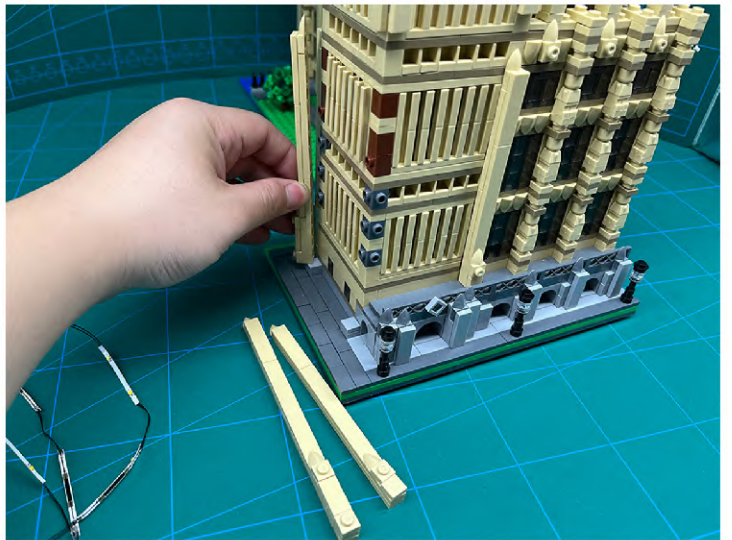
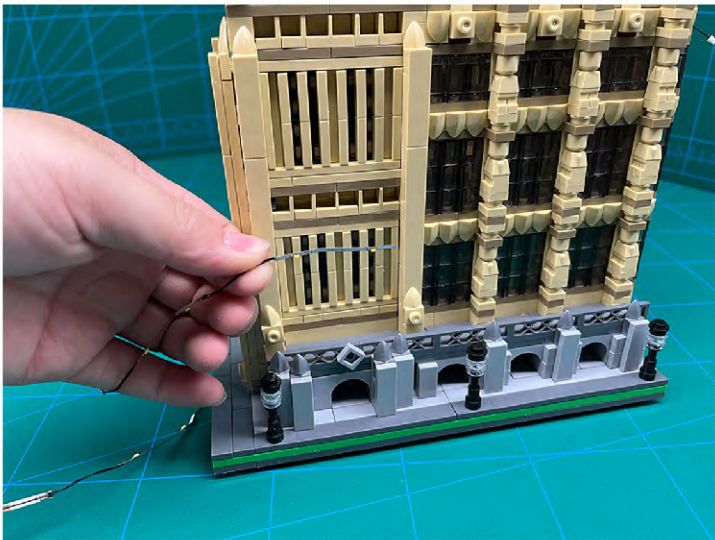
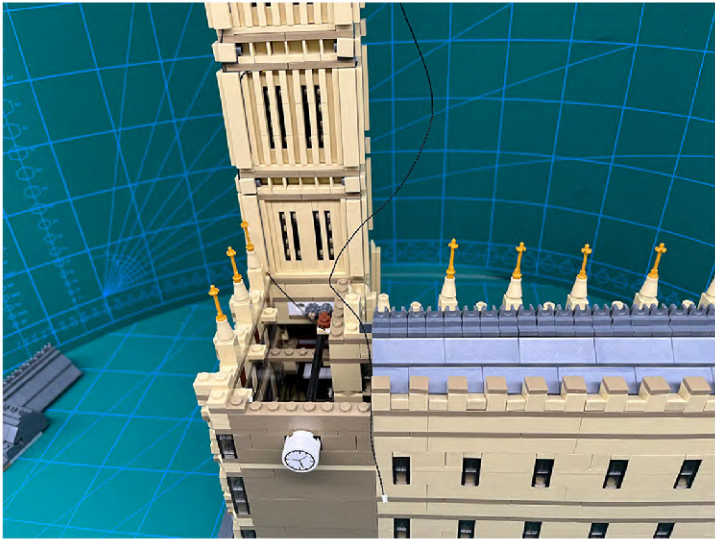
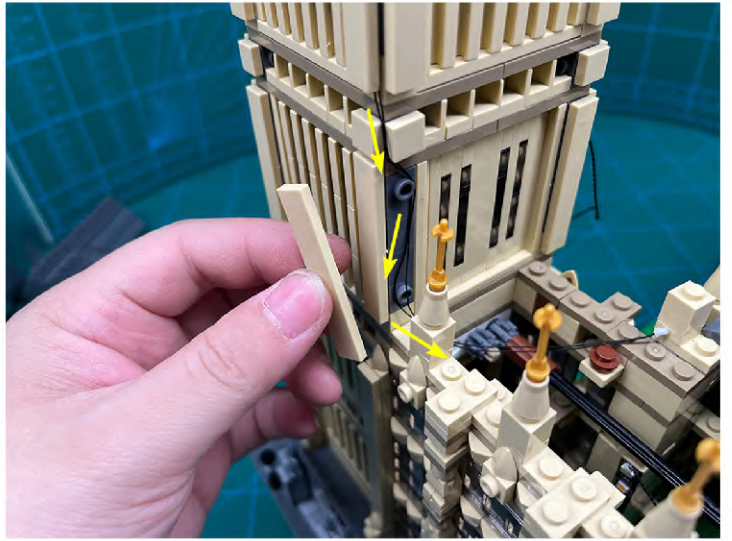

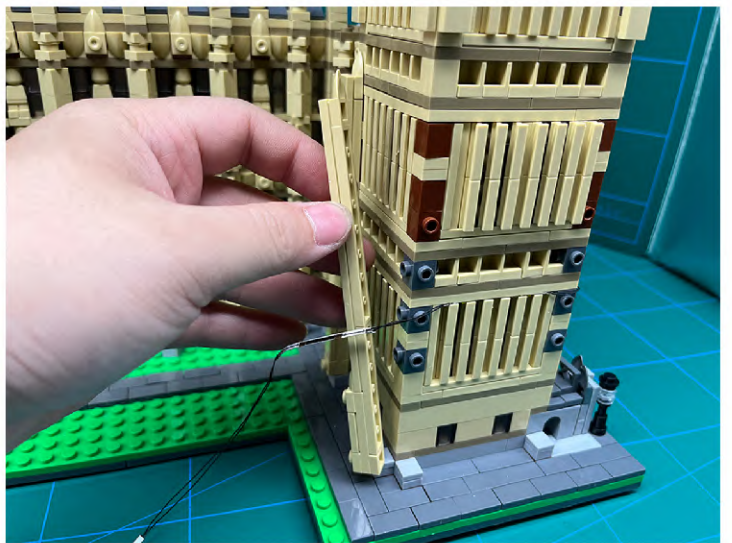
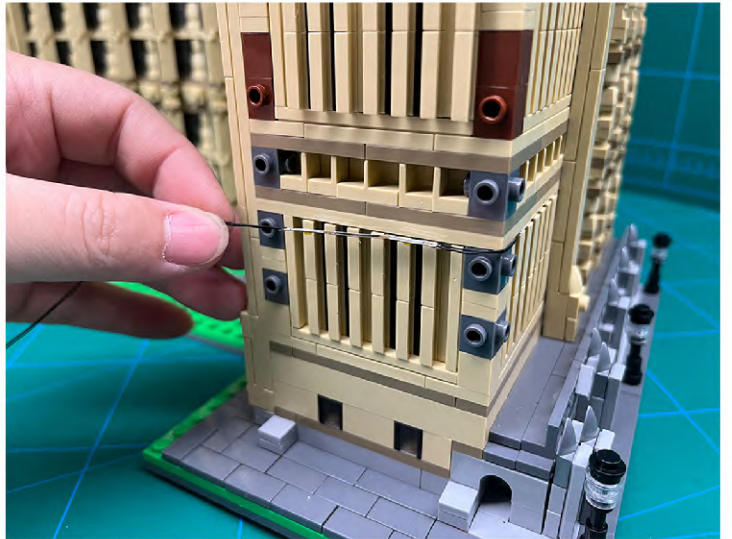
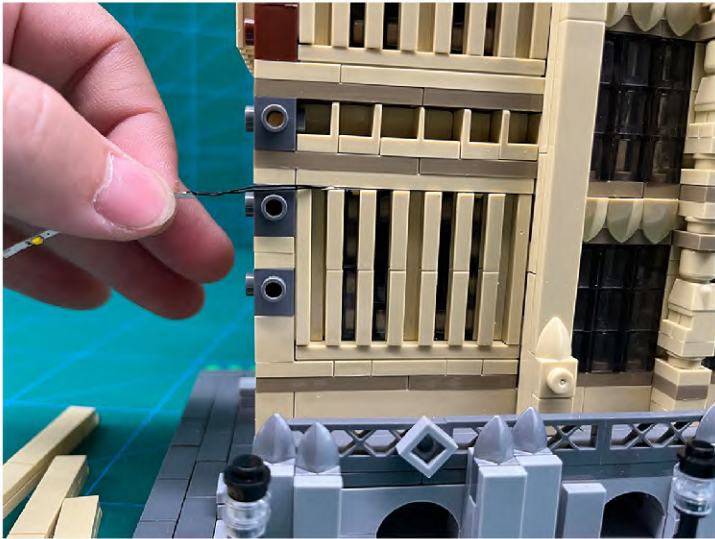
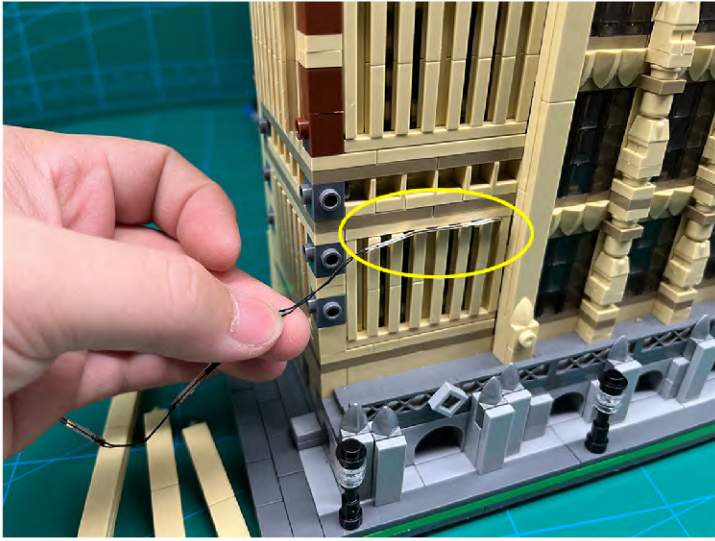

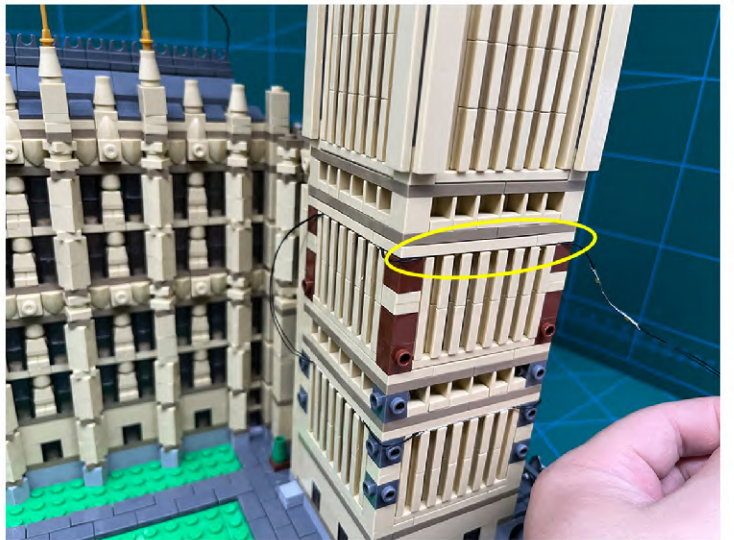
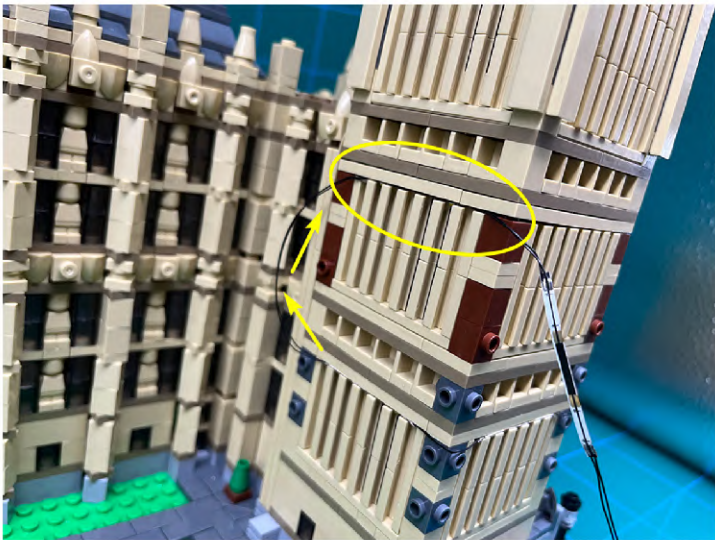
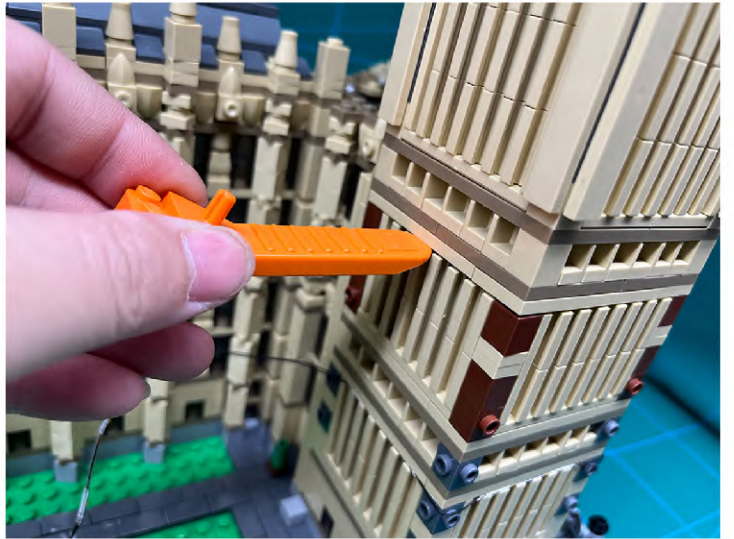
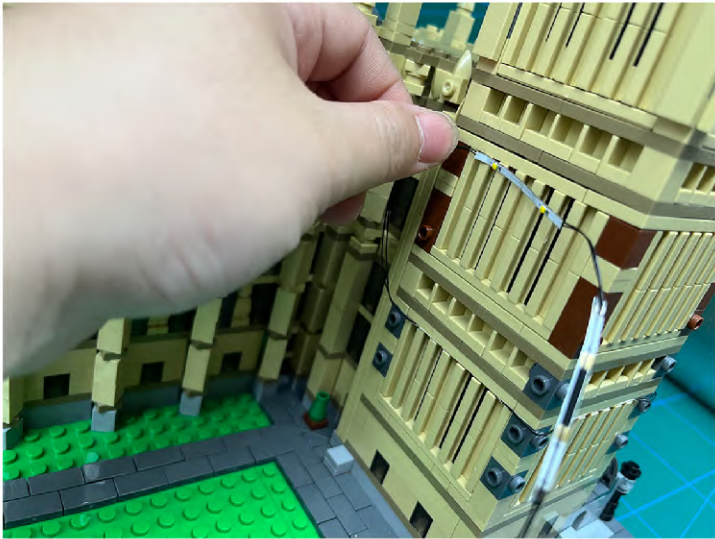
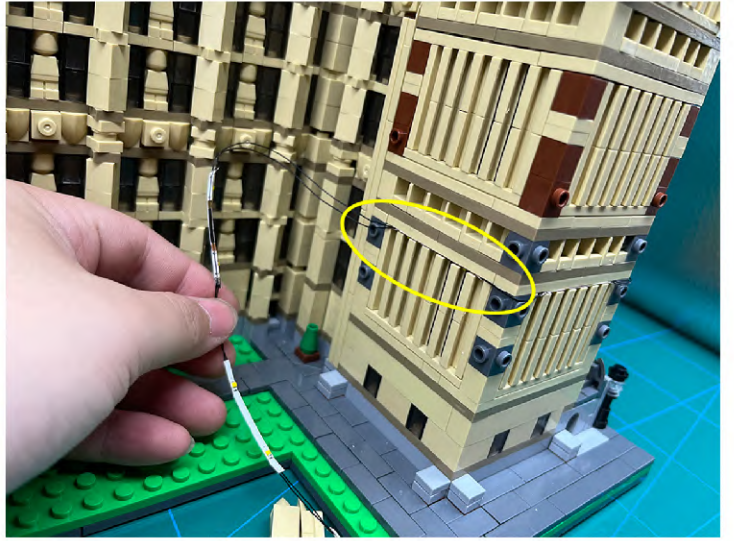

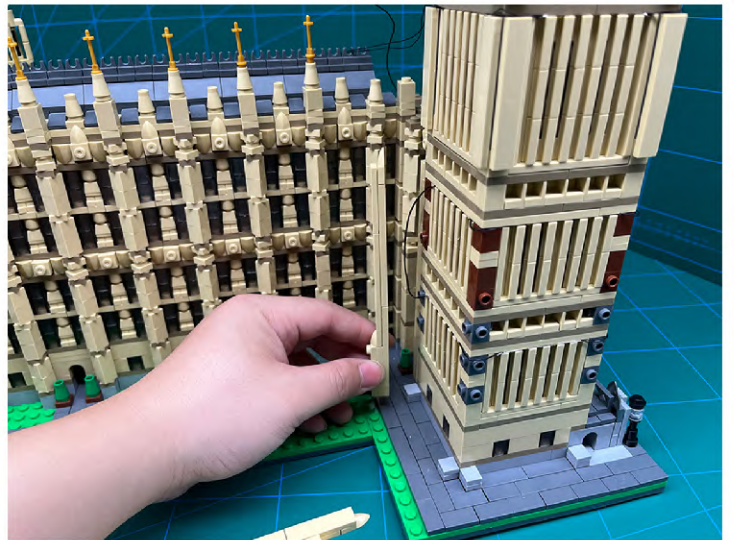
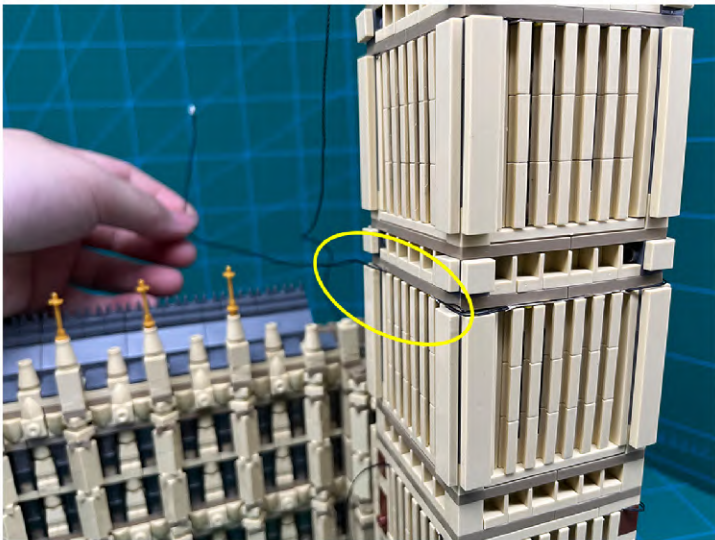
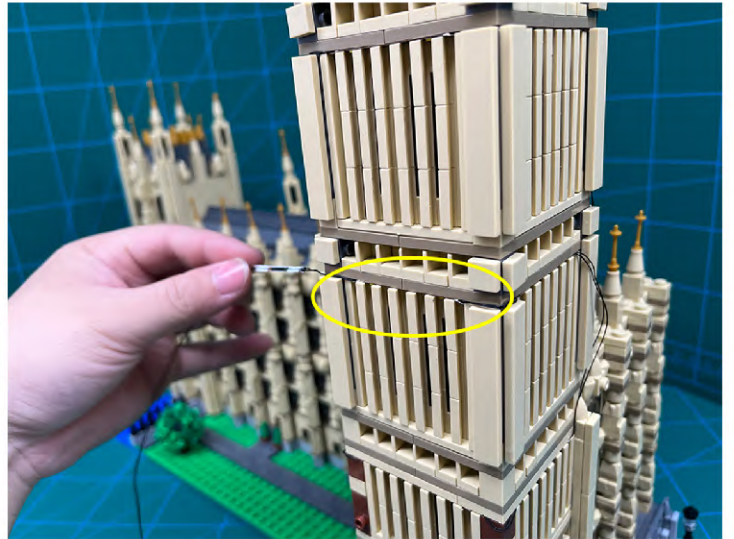
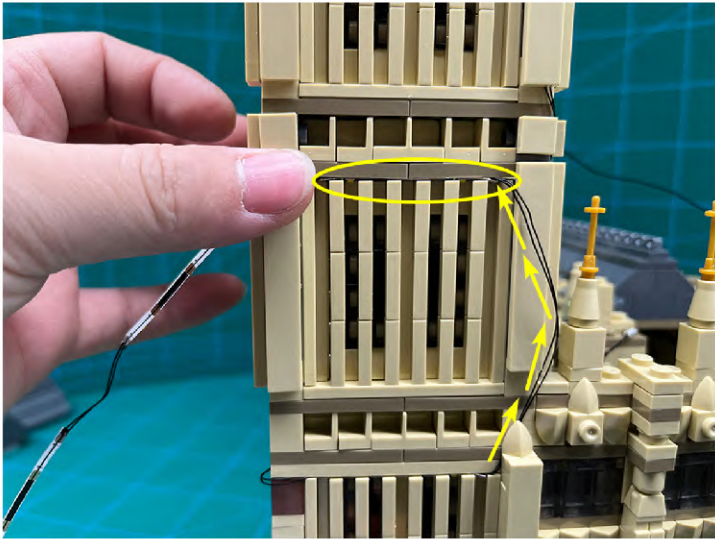
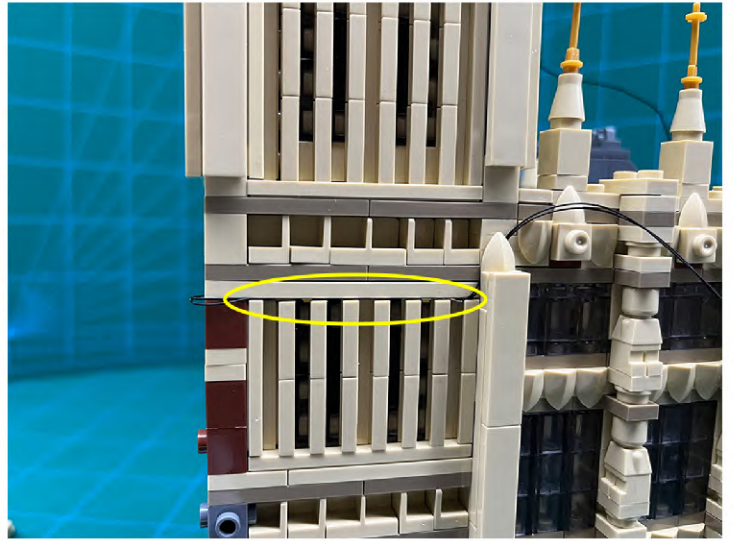
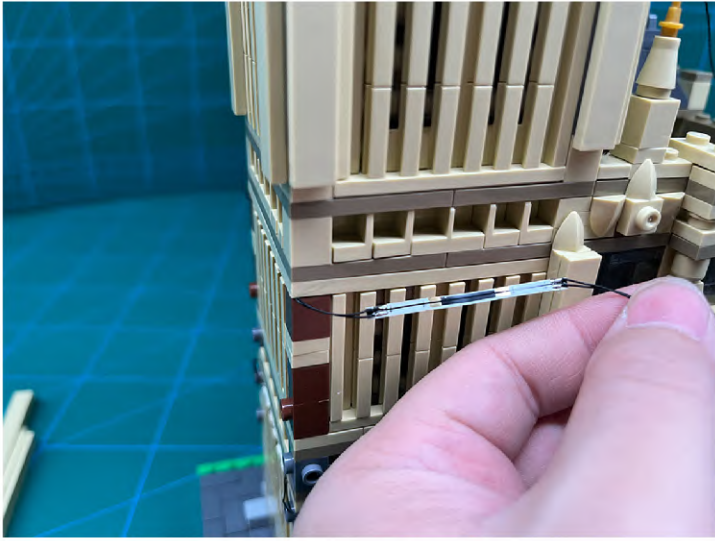

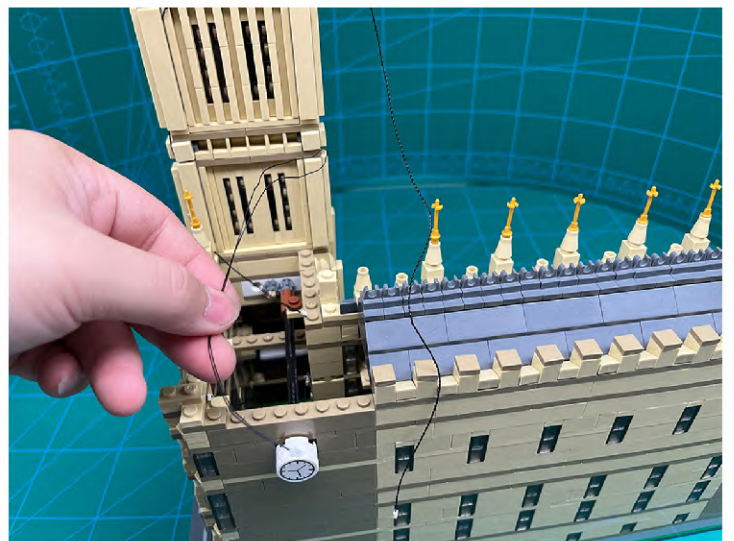
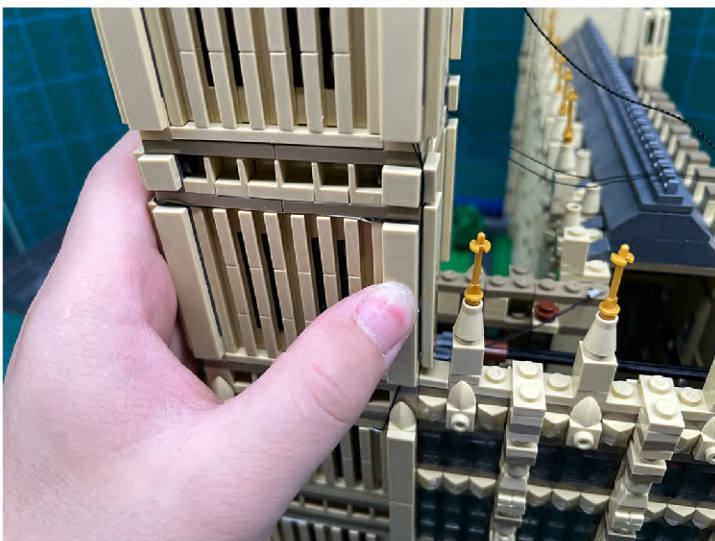
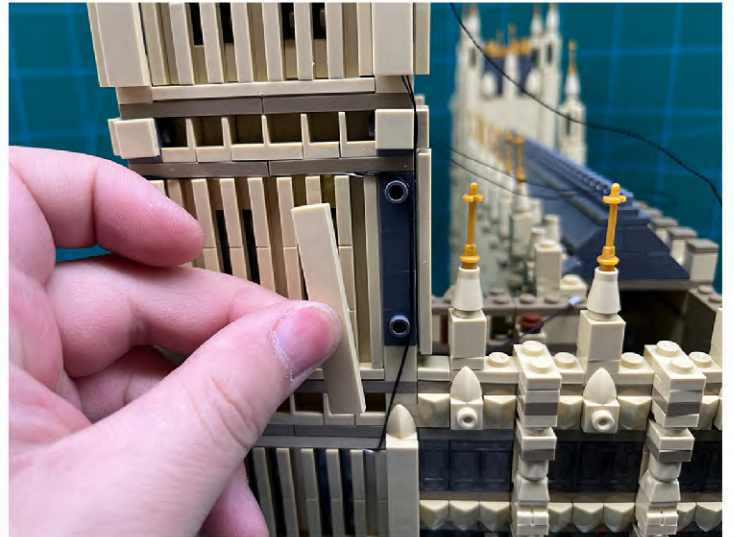
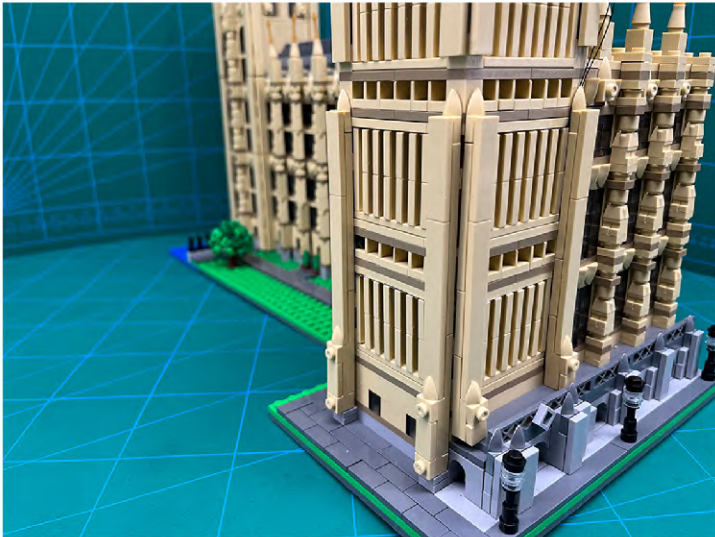
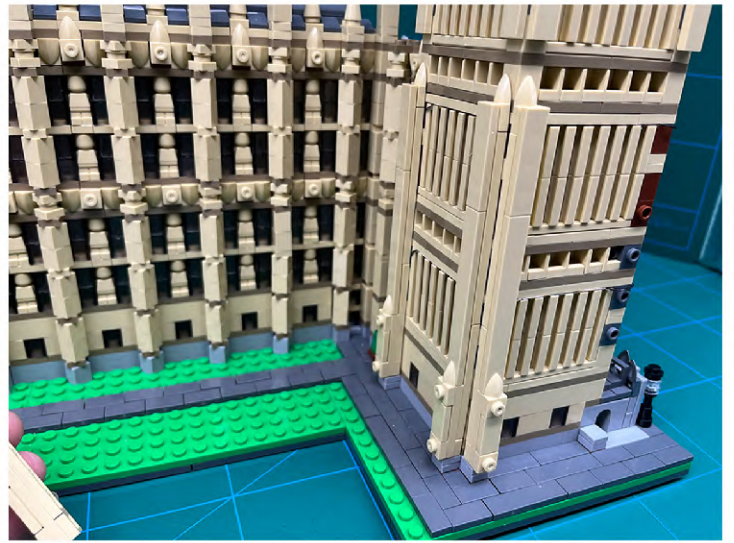
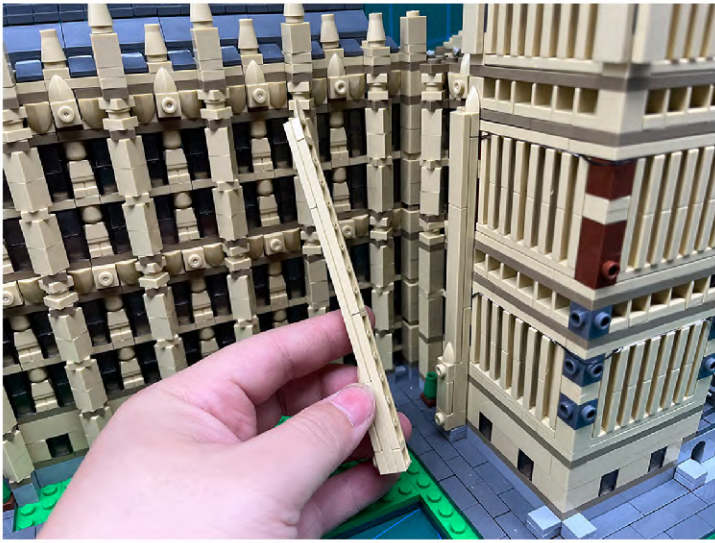

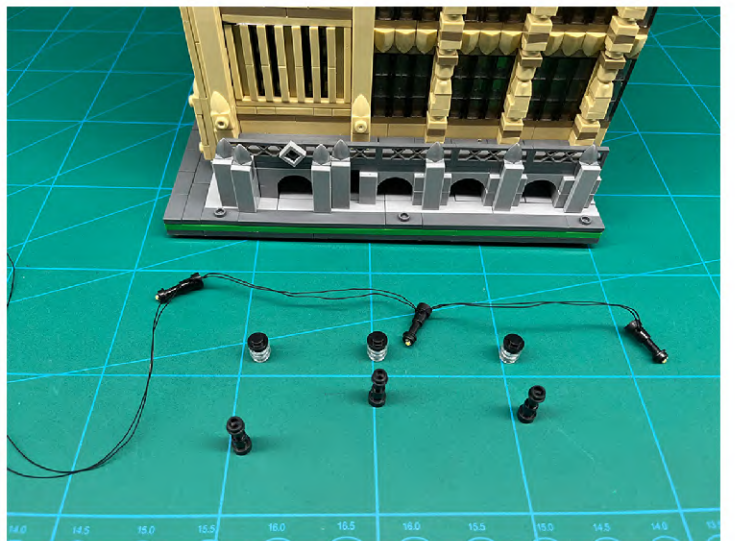
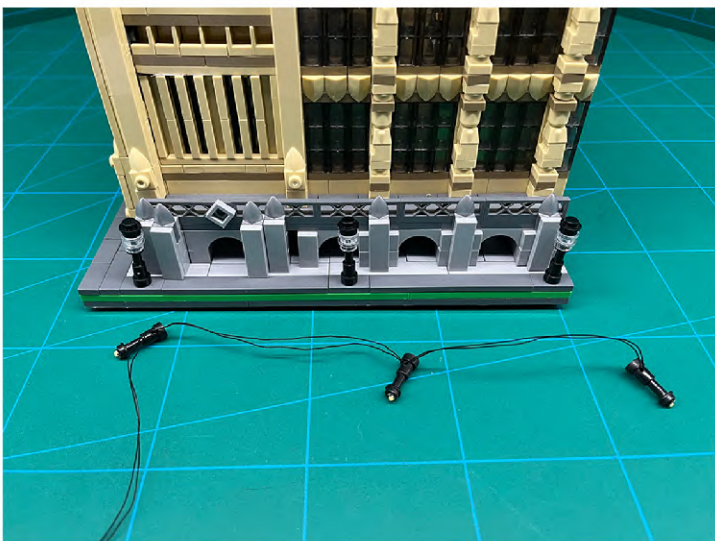
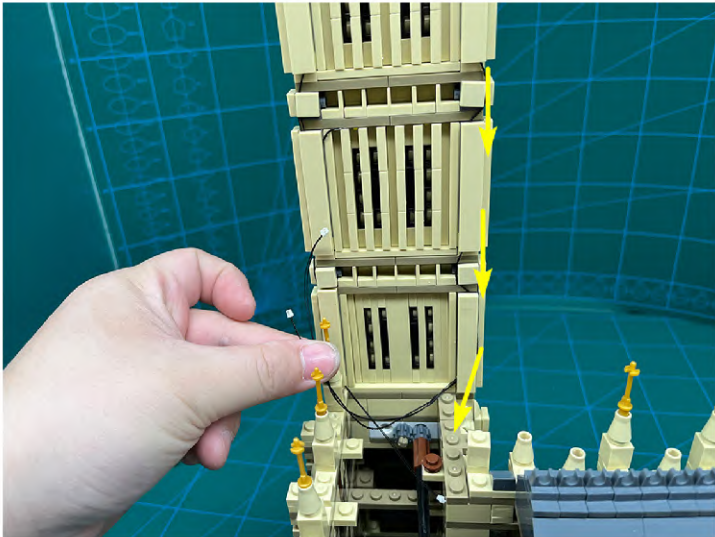
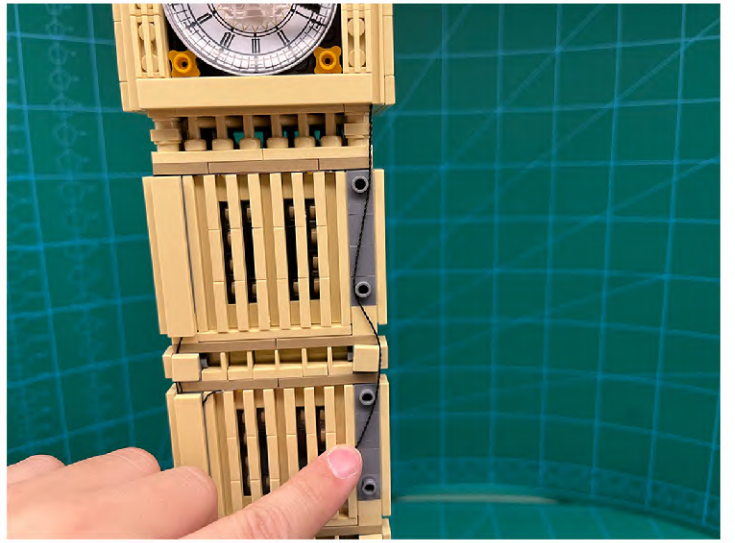
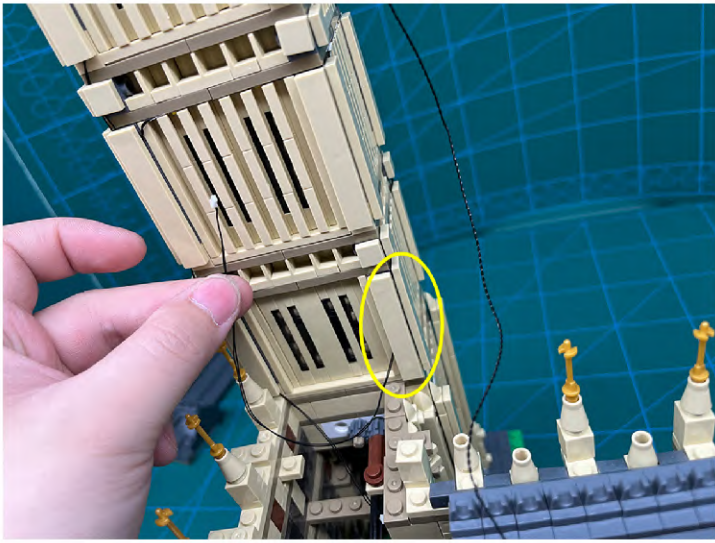

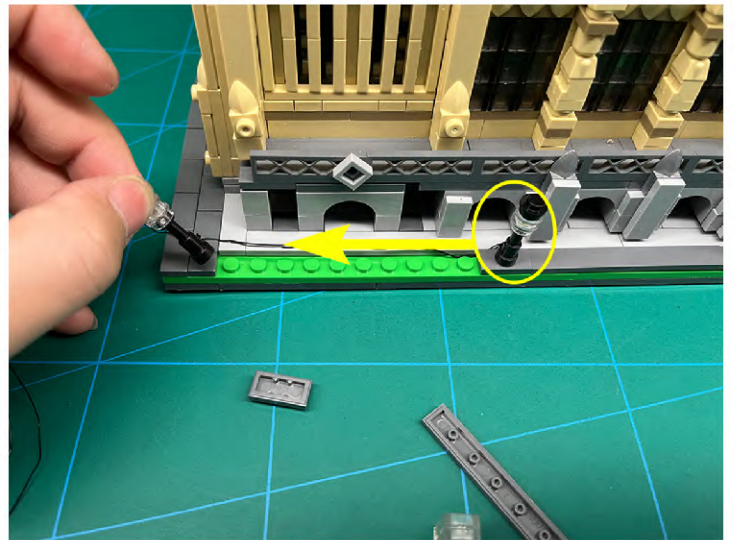
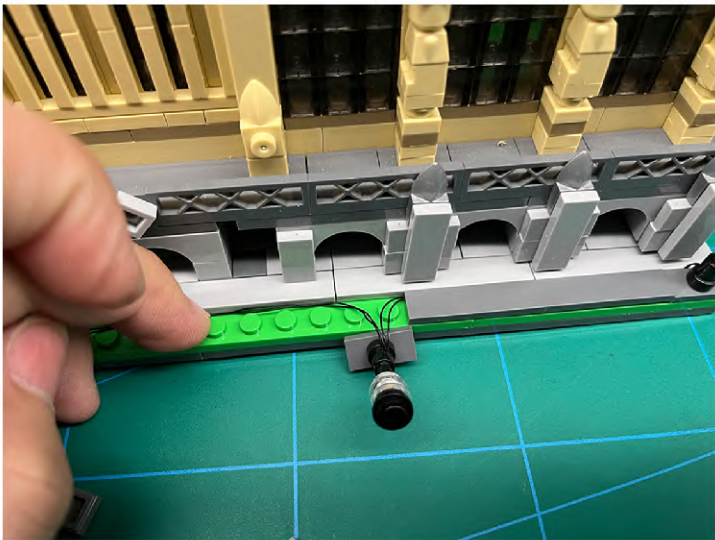
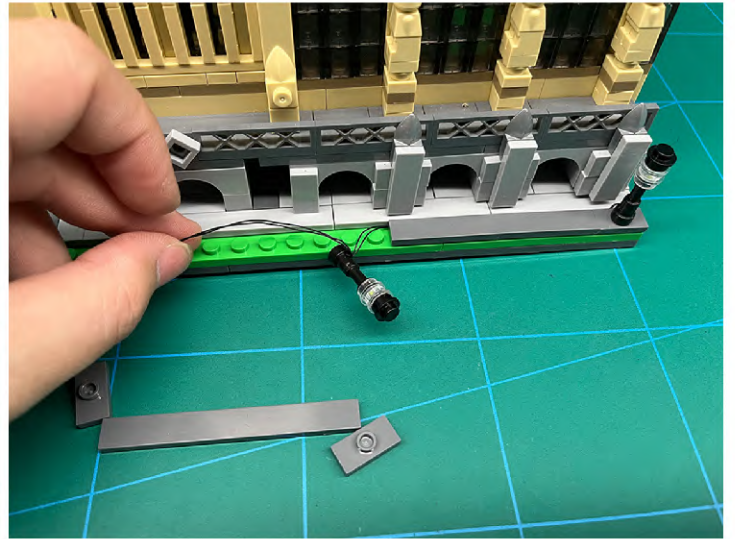
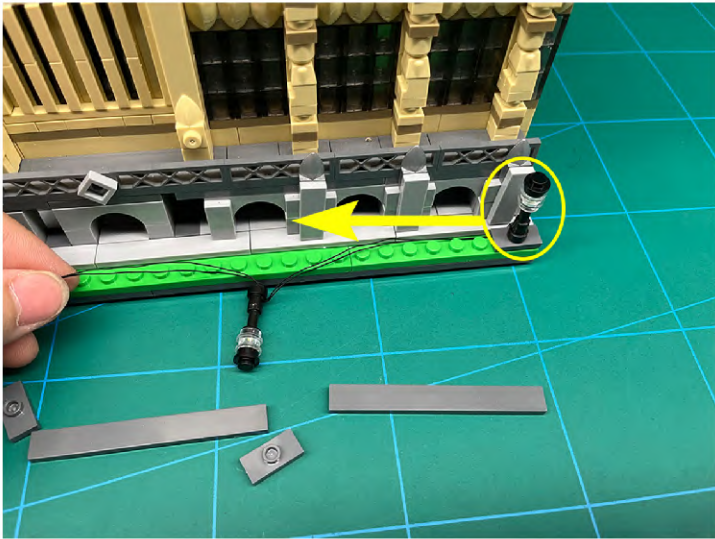
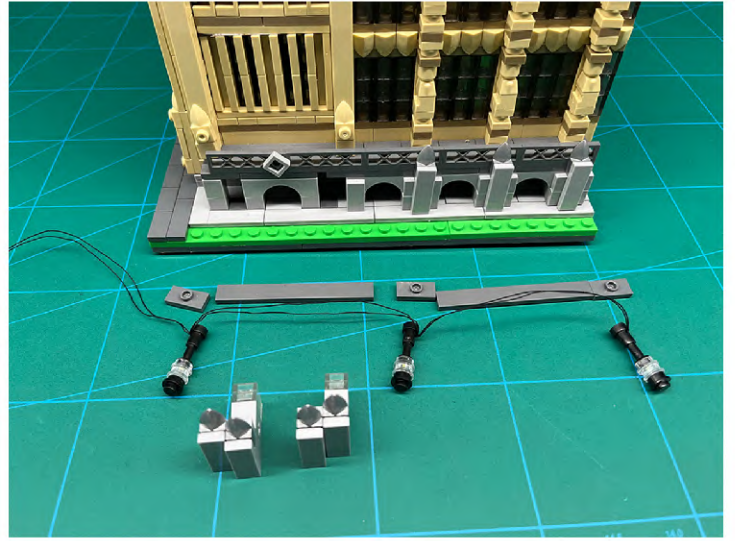
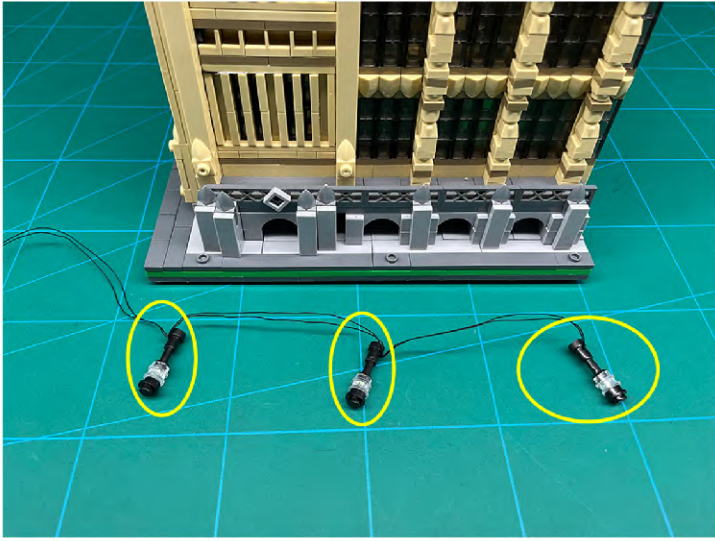

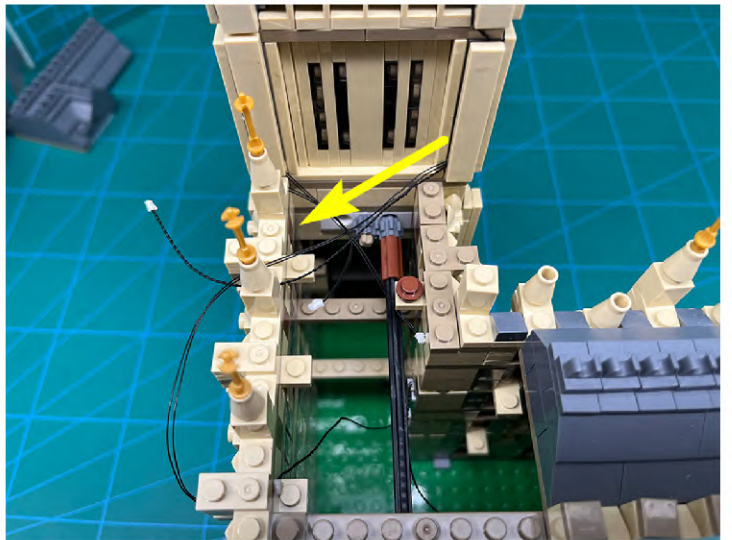
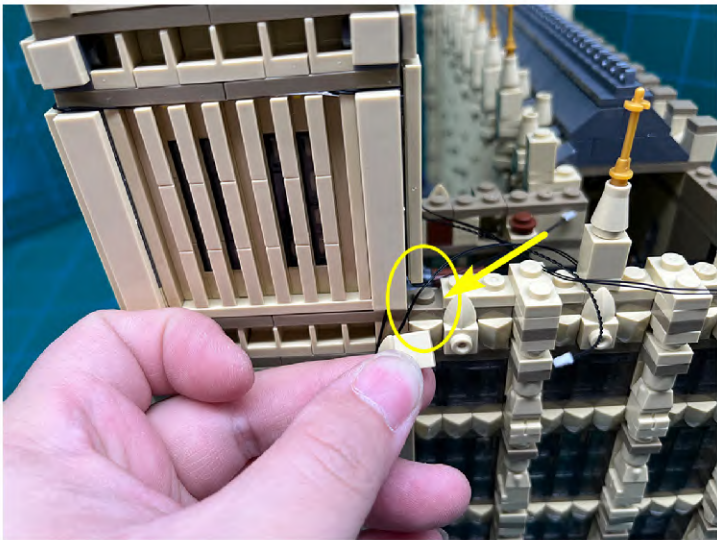
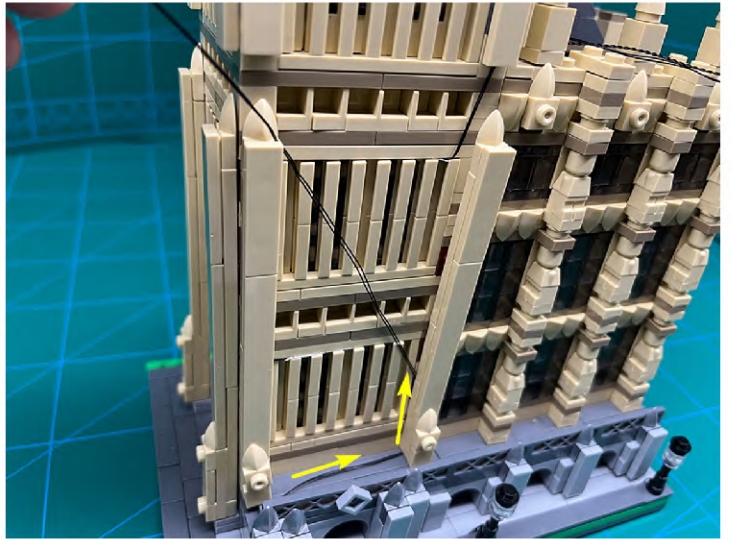
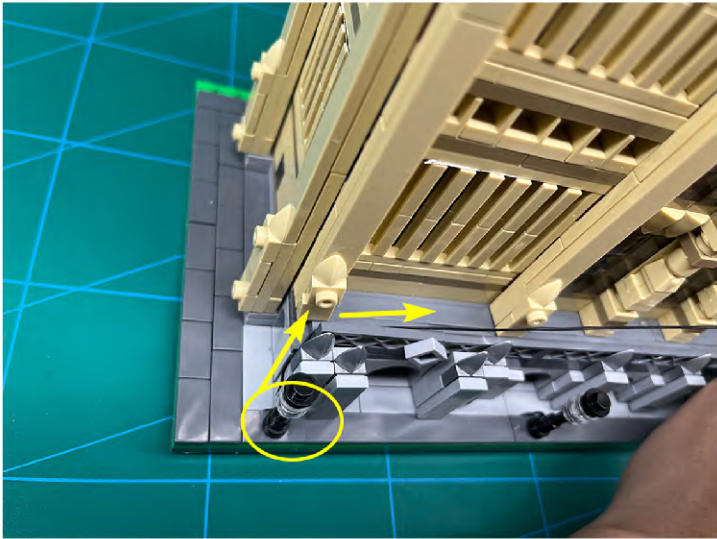
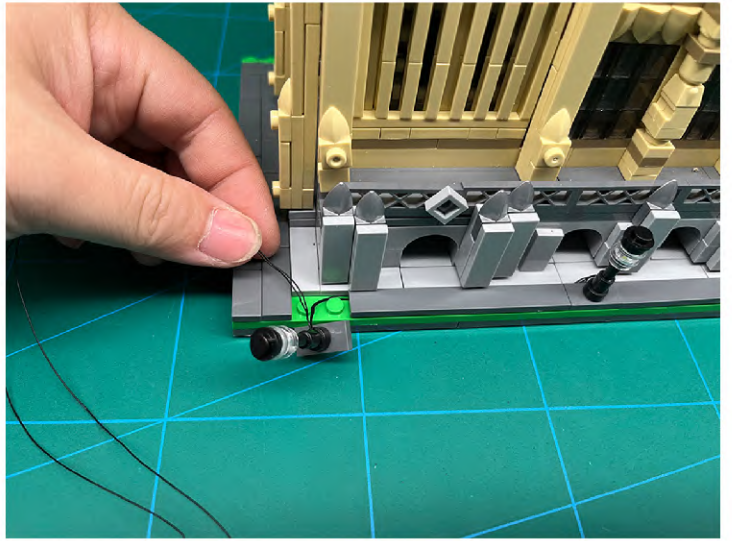
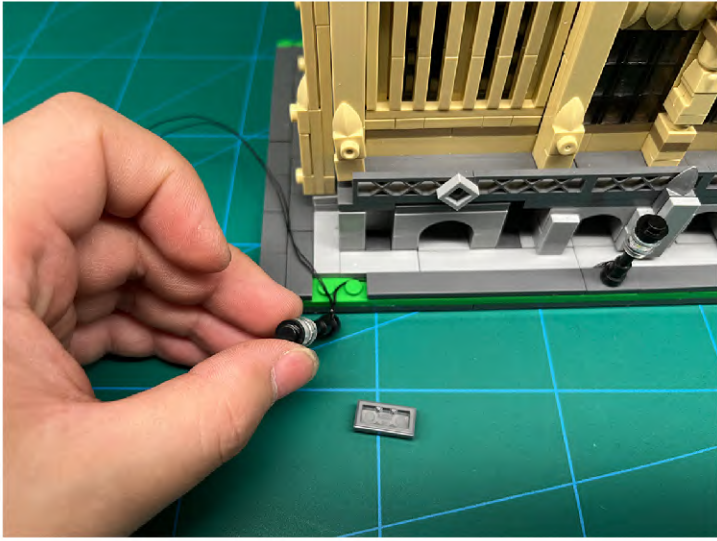

Classic Version

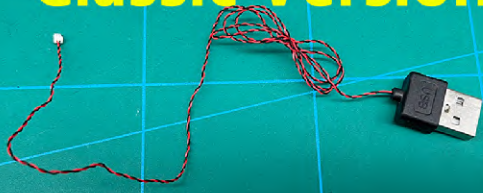

Connecting to power

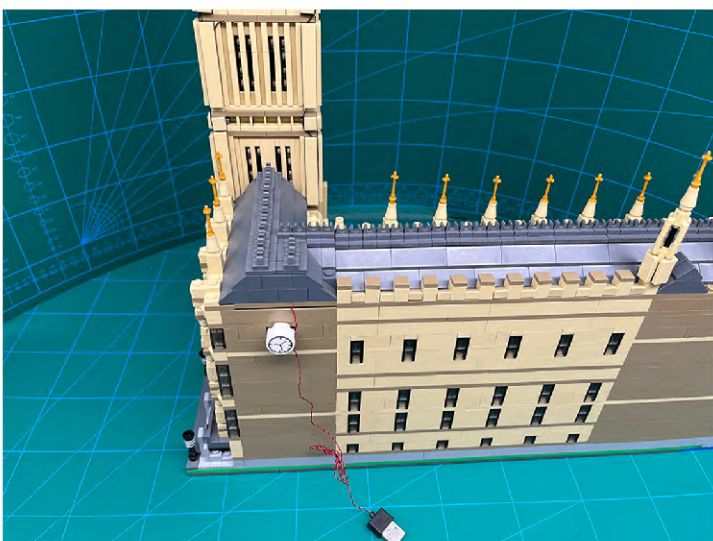
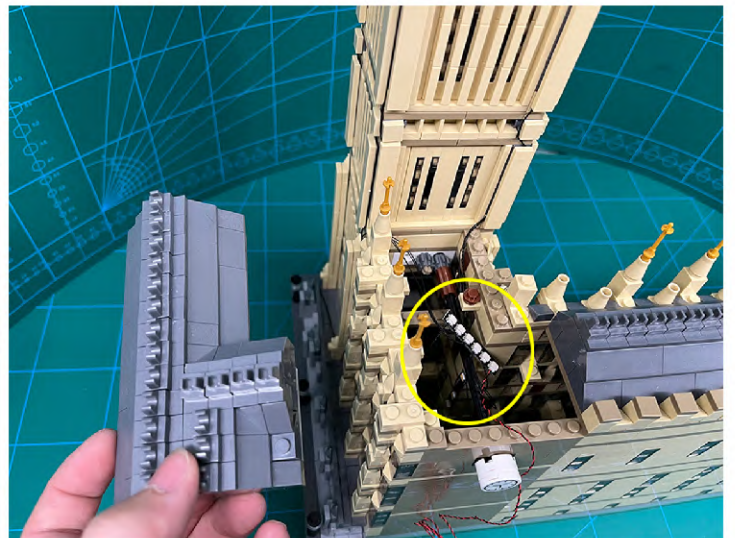
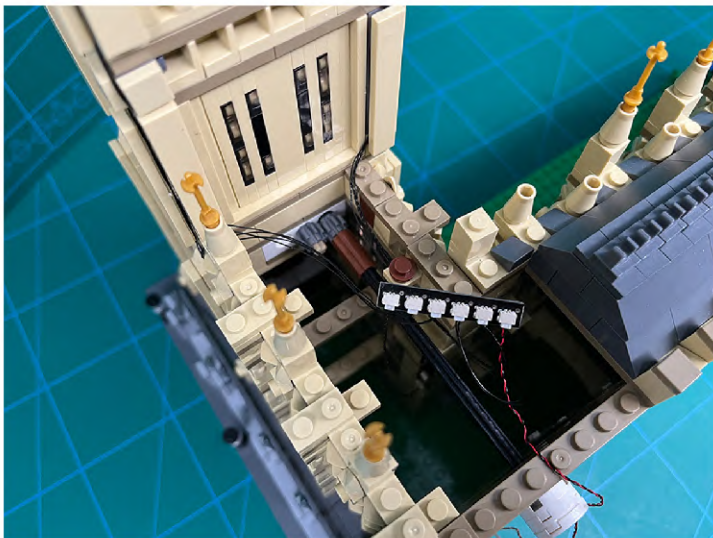
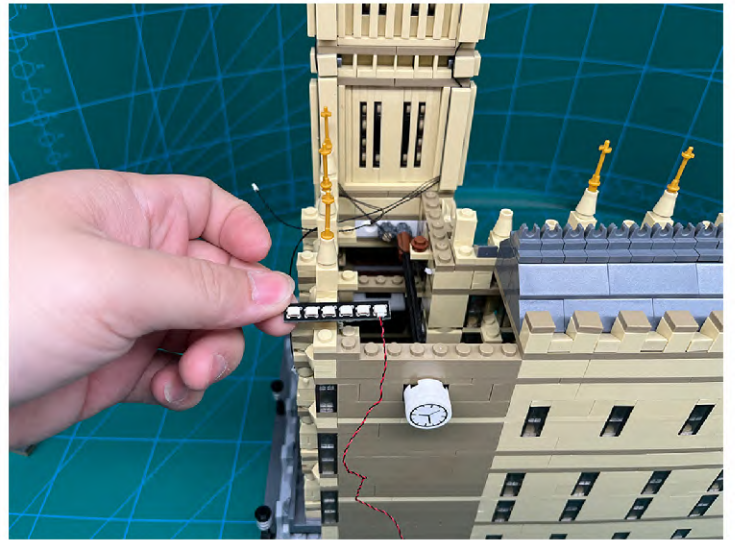

Rc Version



Installing RC Moduel

