

# Accuphase

INTEGRATED STEREO AMPLIFIER

## E-4000

- AAVA volume control
- Power amplification stage configured as instrumentation amplifier
- Four-fold parallel push-pull configuration of power transistors driven in Class AB
- High power output of 180 watts into 8 ohms / 260 watts into 4 ohms
- High damping factor of 800
- Strong power supply with massive high-efficiency toroidal transformer and high-voltage, large filtering capacitors
- Protection circuitry using MOS-FET switches



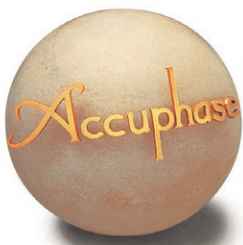

# An integrated amplifier crafted from separate amplifier technologies

The E-4000 integrated amplifier has emerged from separate amplifier technologies. The preamplifier section features AAVA using ANCC to allow for volume adjustments that maintain high levels of vibrancy. The power amp section employs balanced transmission utilizing the instrumentation amplifier principle to drive noise suppression to its limit. The E-4000 is equipped with a four-fold parallel push-pull configuration of power transistors driven in Class AB in the output stage to extract every last ounce of potential from the speakers and create soundscapes filled with subtlety.

## Innovation – At the leading edge of technology

### ■ AAVA volume control circuit

Conventional preamplifiers use variable resistors to adjust volume, which causes contacts to deteriorate and create grit as well as increase noise at normal volume levels. AAVA, however, produces multiple, widely varying signals from the input signal and controls volume by changing the combination of those signals. This achieves minimum noise levels at all volume levels without any grit.

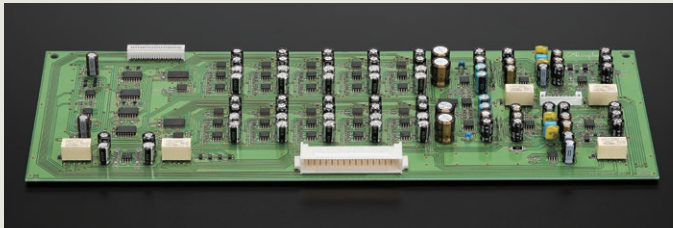

AAVA volume control board

### ■ Drastic reduction of distortion and noise ANCC: Accuphase Noise and distortion Cancelling Circuit

The E-4000 uses ANCC topology for the I-V converter amplifier. This innovative topology adds a sub-amplifier for effectively canceling noise in the main amplifier circuit. The use of low-noise technology in the sub-amplifier (noise density: 1.5 nV /  $\sqrt{\text{Hz}}$ ) further enhances the benefits of ANCC. By incorporating ANCC in the I-V converter amplifier and the balanced amplifier of the AAVA section, a further drastic reduction in noise is achieved, especially at low to medium volume level positions.

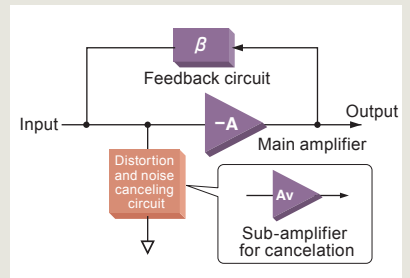

Block diagram of ANCC

### ■ Instrumentation amplifier

With balanced circuits in the signal input section, the amplification stage is comprised entirely of an instrumentation amplifier principle that equalizes input impedance on the + and - sides, for excellent external noise suppression, and providing optimal circuitry for this high-end audio amplifier.

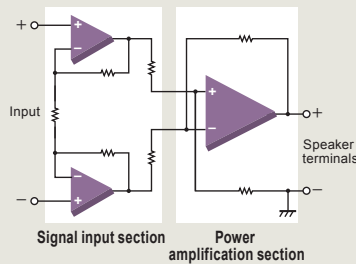

### ■ Balanced remote sensing

Balanced remote sensing improves damping factor by feeding back the GND at the same time as the signal is output from the speaker terminals.

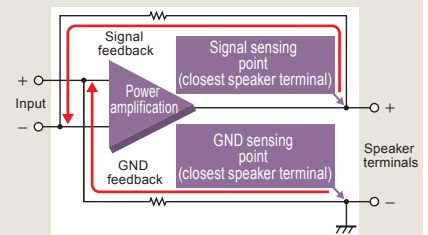

## Sound quality – Simply aiming for the best

### ■ Robust power amplification stage

The power amplification stage on both the left and right sides is equipped with a large heat sink and employs four-fold parallel push-pull power transistors driven in Class AB to provide rated, high-power output of 180 watts into 8 ohms and 260 watts into 4 ohms.

### ■ High damping factor brings out the full potential of the loudspeakers

The damping factor represents the amplifier's ability to drive the speakers. A damping factor of 800 (guaranteed) extracts the maximum potential from the loudspeakers.

### ■ Power supply circuitry designed for optimum stability

A strong power supply featuring a massive toroidal transformer and two high-voltage, large filtering capacitors (40,000  $\mu\text{F}/80\text{ V}$ ) offers a stable power supply at all times.

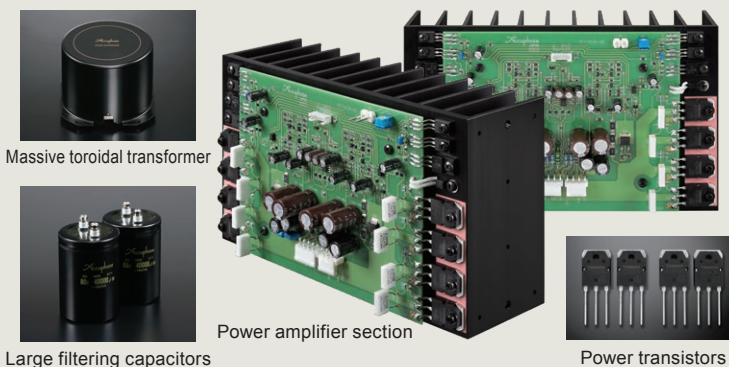
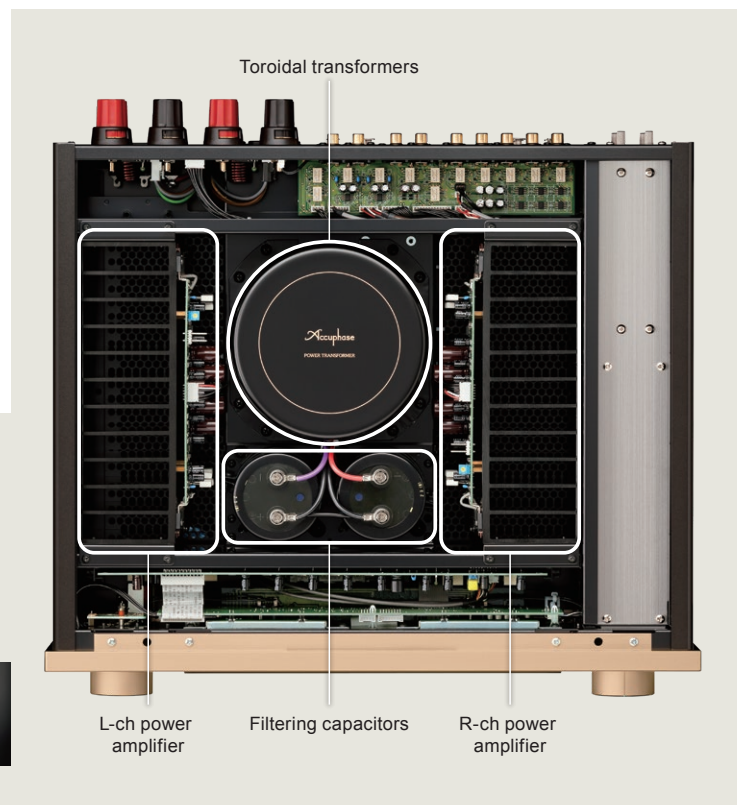

Massive toroidal transformer

Large filtering capacitors

Power amplifier section

Power transistors

L-ch power amplifier

Filtering capacitors

R-ch power amplifier

## Advanced Features

- AAVA volume control circuit
- Highly reliable logic-control signal switching relays
- Power amplification stage configured as instrumentation amplifier
- Current feedback amplification circuit topology assures excellent phase characteristics in high range
- Preamp output connectors (LINE / BALANCED)
- Dedicated, high-quality headphone amplifier
- Volume attenuator that can instantly reduce sound as low as -20 dB
- Speaker output selector .....①
- Tone controls using summing active filters .....②
- Individual phase setting for each input .....③
- Stereo signal can be switched to monophonic operation...④
- Loudness compensator to adjust audible sonic balance...⑤
- DAC input selector (when DAC-60 / DAC-50 / DAC-40 is installed).....⑥
- MC/MM selector (when AD-50 / AD-30 / AD-20 is installed)...⑦
- Display mode selector .....⑧
- Left/right balance control through AAVA .....⑨
- Input selector for power amplifier section (LINE / BALANCED) ...⑩
- Recorder selector .....⑪
- Five sets of LINE input connectors .....⑫
- Speaker output protection circuit guards against short-circuiting .....⑬
- Two sets of balanced line inputs .....⑭
- Two sets of large speaker terminals .....⑮
- Volume display .....⑯
- Sampling frequency display .....⑰  
(when DAC-60 / DAC-50 / DAC-40 is installed)
- Highly reliable MOS-FET switches .....⑱
- High-carbon cast iron insulators for superior vibration damping.....⑲

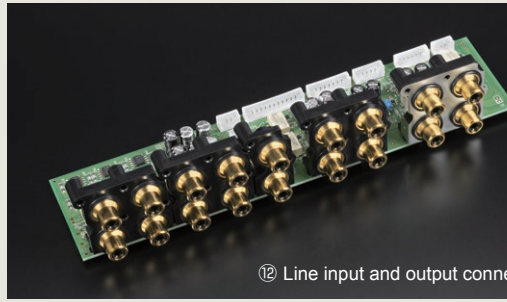
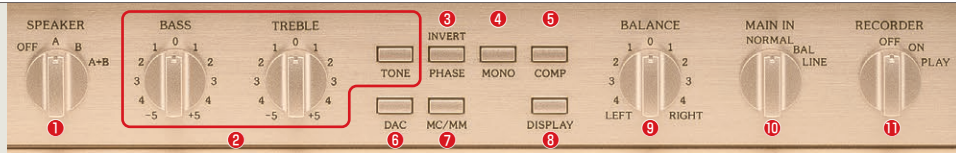

⑫ Line input and output connectors

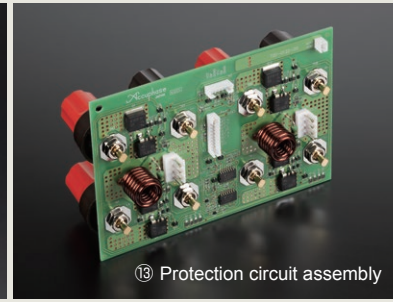

⑬ Protection circuit assembly

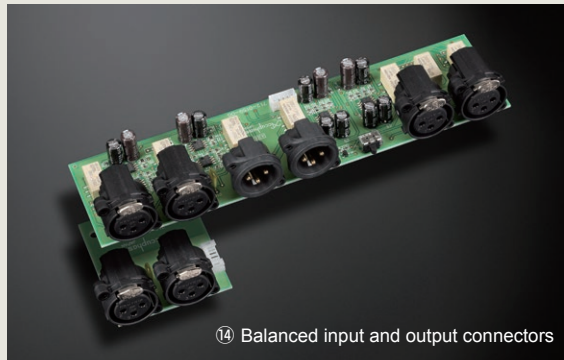

⑭ Balanced input and output connectors

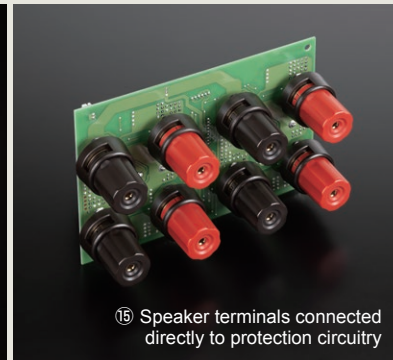

⑮ Speaker terminals connected directly to protection circuitry



⑯ Volume display



⑰ Sampling frequency display



⑱ MOS-FET switches



⑲ High-carbon cast iron insulators



A highly-sensitive, large analog power meter capable of displaying output levels to -50 dB

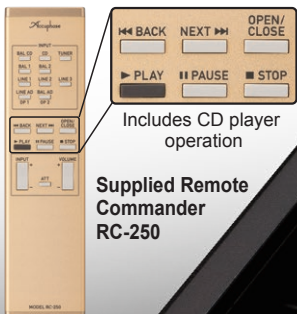

## Bi-amping for Further Enhanced Sound

In a bi-amped setup, the speaker units for the Low frequency range and the High frequency range are driven by separate amplifiers with equal gain, enabling playback with even higher sound quality.

\*The speakers must have a built-in crossover network and separate inputs for the Low and High ranges.

\*The example shows a setup with an additional power amplifier for the Low frequency range.

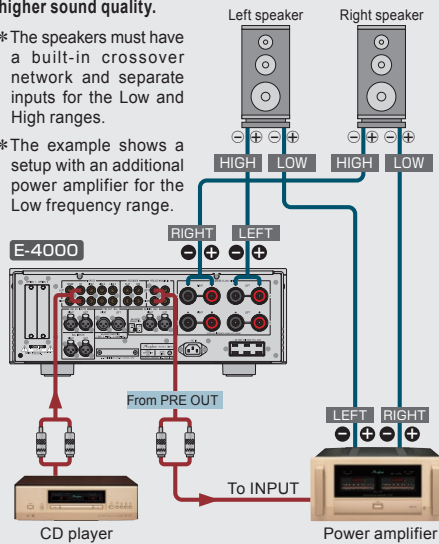

## Option Boards



Option board installation example

The rear panel expansion slots allow use of three types of option boards (DAC-60, AD-50, LINE-10). Up to two boards can be installed, according to requirements.

■ The following option boards can also be used:

Digital Input Board	DAC-50 / DAC-40 / DAC-30 / DAC-20 / DAC-10
Analog Record Input Board	AD-30 / AD-20 / AD-10 / AD-9
Line Input Board	LINE-9

### Analog Record Input Board AD-50



Features a high-performance phono equalizer for playback of analog records.

- Supports MC and MM cartridges
- Load impedance selection (MC only)
- Subsonic filter

Cartridge	MC	MM
	Gain	66 dB
Input Impedance	30 ohms	47 kilohms
	100 ohms	300 ohms

AD-50

### Digital Input Board DAC-60



Connection example

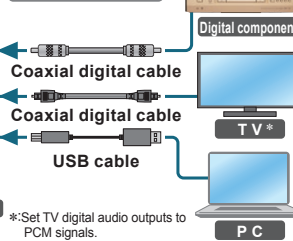

\*:Set TV digital audio outputs to PCM signals.

High-performance DAC with two ES9016K2M chips from ESS Technology driven in parallel.

Input	Signal	Sampling frequencies	Number of bits
USB	DSD	2.8 MHz	1-bit
		5.6 MHz	
		11.2 MHz [ASIO only]	
OPTICAL	PCM	32 to 384 kHz	32-bit
		32 to 96 kHz	24-bit
COAXIAL	PCM	32 to 192 kHz	24-bit

### Line input board LINE-10



Provides an additional set of unbalanced line level inputs.

## Front Panel

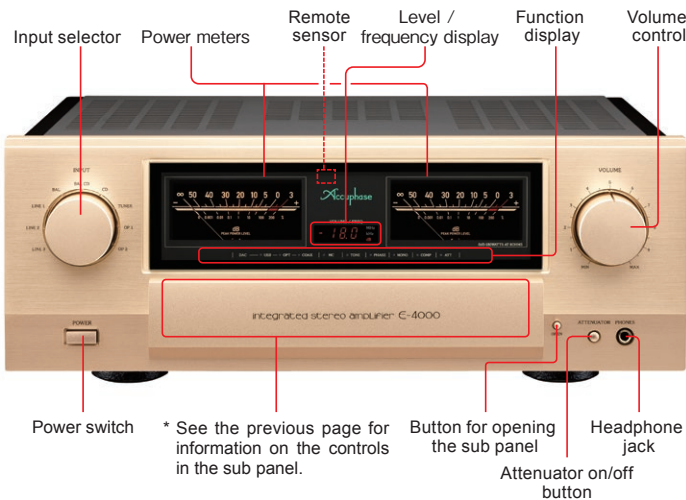

- Input selector
- Power meters
- Remote sensor
- Level / frequency display
- Function display
- Volume control
- Power switch
- \* See the previous page for information on the controls in the sub panel.
- Button for opening the sub panel
- Headphone jack
- Attenuator on/off button

## Rear Panel

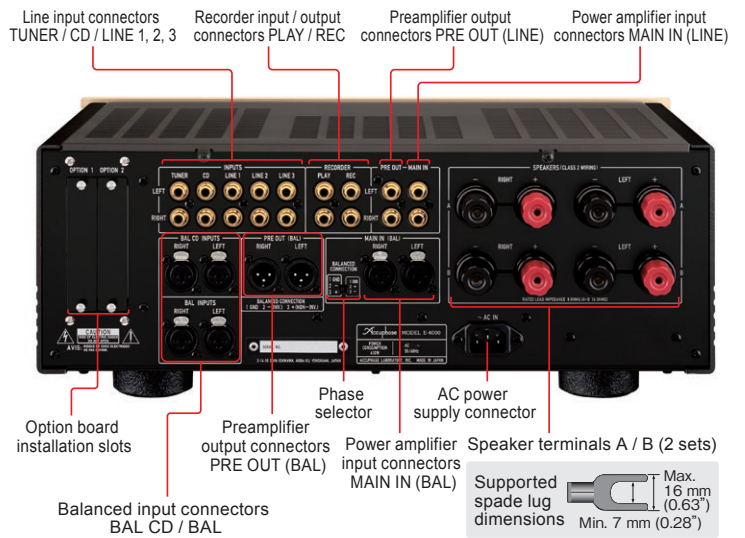

- Line input connectors TUNER / CD / LINE 1, 2, 3
- Recorder input / output connectors PLAY / REC
- Preamplifier output connectors PRE OUT (LINE)
- Power amplifier input connectors MAIN IN (LINE)
- Option board installation slots
- Preamplifier output connectors PRE OUT (BAL)
- Power amplifier input connectors MAIN IN (BAL)
- Phase selector
- AC power supply connector
- Balanced input connectors BAL CD / BAL
- Speaker terminals A / B (2 sets)
- Supported spade lug dimensions: Max. 16 mm (0.63"), Min. 7 mm (0.28")

## E-4000 Guaranteed Specifications

Rated Output (20 to 20,000 Hz, 0.05%)	Both channels driven	4-ohm load *	260 W / ch
		8-ohm load	180 W / ch
Total Harmonic Distortion (20 to 20,000 Hz)	Both channels driven	4 to 16-ohm load	0.05%
		Intermodulation Distortion 0.01%	
Frequency Response	At rated output	INPUT (BALANCED / LINE) 20 to 20,000 Hz (0, -0.5 dB)	
	At 1 W output	MAIN IN (BALANCED / LINE) 20 to 20,000 Hz (0, -0.2 dB)	
Damping Factor	800		
	Input Sensitivity	At rated output	INPUT (BALANCED / LINE) 190 mV
EIA (at 1 W output)		MAIN IN (BALANCED / LINE) 1.51 V	
		INPUT (BALANCED / LINE) 14.2 mV	
		MAIN IN (BALANCED / LINE) 113 mV	
Input Impedance	INPUT (BALANCED)		40 kilohms
	INPUT (LINE)		20 kilohms
	MAIN IN (BALANCED)		40 kilohms
	MAIN IN (LINE)		20 kilohms
Max. Input Voltage	INPUT (BALANCED / LINE)		5.0 V
Output Voltage	At rated output	PRE OUTPUT (BALANCED / LINE)	1.51 V
Output Impedance	At rated output PRE OUTPUT (BALANCED / LINE)		50 ohms
Gain	INPUT (BALANCED / LINE) → PRE OUTPUT (BALANCED / LINE)		18 dB
	MAIN IN (BALANCED / LINE) → SPEAKER OUTPUT		28 dB

\*: Limited to music signals

Tone Controls	Turnover frequency and adjustment range	Bass: 300 Hz	±10 dB
		Treble: 3 kHz	±10 dB
Loudness Compensator	+6 dB (100 Hz)		
Attenuator	-20 dB		
S/N Ratio	At rated output (INPUT shorted, A weighting)	INPUT (BALANCED)	102 dB
		INPUT (LINE)	109 dB
	EIA	MAIN IN (BALANCED / LINE)	125 dB
		MAIN IN (BALANCED / LINE)	101 dB
Power Meters	Logarithmic type peak level display of output in dB or %		
Stereo Headphones	Compatible impedance		8 ohms or higher
Power Requirements	120 V, 220 V, 230 V AC (voltage as indicated on rear panel)		
Power Consumption	50 / 60 Hz		
	Idle	54 W	
	In accordance with IEC 62368-1	248 W	
Maximum dimensions	Stand-by 0.3 W		
	Width 465 mm (18.3") × Height 181 mm (7.1") × Depth 428 mm (16.9")		
Mass	Net	24.4 kg (53.8 lbs)	
	In shipping carton	31 kg (69 lbs)	

### Supplied accessories

- AC power cord
- Remote Commander RC-250

### Remarks

- ★ This product is available in versions for 120/220/230 V AC. Make sure that the voltage shown on the rear panel matches the AC line voltage in your area.
- ★ The 230 V version has an Eco Mode that switches power off after 120 minutes of inactivity.
- ★ The shape of the plug of the supplied AC power cord depends on the voltage rating and destination country.

