



A8

OWNER'S MANUAL





PRODUCT INFORMATION

Important Safeguards.....4
Cautions Before Installation.....6
Safety Information.....9
Main Unit & Parts.....12

PRODUCT INSTALLATION

Installation.....14
Operation.....20

PRODUCT SETTINGS

Cleaning.....27
Maintenance.....29
Before Calling For Service.....31
Specifications.....32

WARRANTY

Warranty.....33



READ ALL OPERATING INSTRUCTIONS BEFORE INSTALLATION

NOTES

1. This product should be installed according to this manual.
2. Read this manual carefully and install it properly.
3. Keep this instruction manual in an easily accessible place.
4. Do not attempt to service this appliance yourself. Doing so will void the warranty.

DANGER - To reduce the risk of electric shock.

1. Do not place or store this appliance in a location where it can fall or be pulled into a tub or sink.
2. Do not place in, or drop into water or other liquids.
3. Do not touch a product that has fallen into the water. Unplug immediately.

WARNING - To reduce the risk of burns, electric shock, fire, or injury.

1. Close supervision is necessary when this appliance is used by or is near infants, elders, or with disability persons. Children should not be permitted to use or touch this appliance without adult supervision. Be sure to adjust the toilet seat's temperature for elders, with disability persons, or people with sensitive skin.
2. Use this appliance only for its intended purpose as described in this manual. Only use attachments recommended by the manufacturer.
3. Do not operate this appliance if the cord is damaged or if the product is dropped into water.
4. Install the unit properly by following the installation procedure.
5. Only authorized persons can install or repair the unit. Do not attempt to service this appliance by yourself. Doing so could void the warranty.
6. Keep the cord away from heated surfaces.
7. Never drop or insert any objects into any opening or hose.
8. Do not use outdoors. Do not use aerosol or oxygen spray products on the unit.
9. Always follow the grounding instructions in this manual before plugging in the unit.

SAVE THESE INSTRUCTIONS



NOTE THE FOLLOWING IMPORTANT POINTS

1. Do not install in a location where water might be splashed on this appliance or in a location exposed to excessive moisture where condensation might form on the product's surface.
2. To avoid damage to electronic components due to high levels of humidity, provide adequate ventilation by opening a window and/or door when bathing.
3. The water supply should have a water pressure of 0.07 MPa to 0.74 MPa.
4. Connect the product to a pipe carrying potable water. Do not connect to an industrial water line or other water supplies that are not potable.
5. Bring the unit to room temperature.
6. The thermal protector in the water tank may malfunction when transporting or storing warm water.
7. The rated power voltage in AC 120V, 60Hz
8. Do not plug the unit in until installation is complete. It may result in malfunction.

WIRING REQUIREMENTS

1. After installation, all other servicing should be performed by authorized service representatives.
2. **Grounding Instructions**
This product should be grounded. In the event of an electrical short circuit, grounding reduces the risk of electric shock by providing an escape wire for the electric current. This product is equipped with a cord having a grounding wire and grounding plug. They must be plugged into an outlet that is properly installed and grounded.

DANGER - Improper use of the grounding plug can result in a risk of electric shock.

If it is necessary to repair or replace the cord or plug, do not connect the grounding wire to a flat blade terminal. The grounding wire can be identified by its insulated outer surface. It will either be colored green or will not contain yellow stripes.

Check with a qualified electrician or serviceman if you do not understand the grounding instructions or if you do not know whether the product is properly grounded.



3. This product is for use on a nominal 120V circuit. It has a grounding plug that is similar to the plug illustrated in sketch A. A temporary adapter, which looks like the adapter illustrated in sketches B and C may be used to connect this plug to a 2-pole receptacle as shown in sketch B if a properly grounded outlet is not available. The temporary adapter should be used only until the properly grounded outlet (sketch A) can be installed by a qualified electrician. The green-colored rigid ear, lug, and the like extending from the adapter must be connected to a permanent ground such as a properly grounded outlet box cover. Whenever the adapter is used, it must be held in place by the screw.

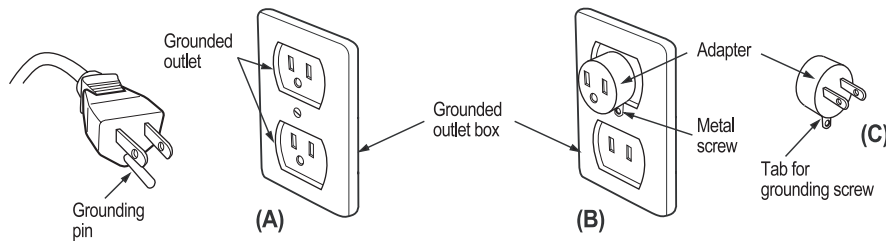

4. If it is necessary to use an extension cord, use only a three-wire extension cord that has a three-blade grounding plug, and a three-slot receptacle that will accept the plug on the product. Do not use a damaged extension cord.
5. Remote control power: AAA (1.5V) 3EA

CAUTION - RISK OF EXPLOSION TO BATTERY IF REPLACED BY AN INCORRECT TYPE. DISPOSE OF USED BATTERIES ACCORDING TO THE INSTRUCTIONS.

DANGER - FAILURE TO FOLLOW MAY CAUSE SEVERE INJURY OR DEATH. FOLLOW THE INSTRUCTIONS.

- **Do not splash water or cleansers on the product's plug.**
Doing so may result in fire or electric shock.
- **Do not plug or unplug with wet hands.**
It may result in injury or electric shock. Regularly wipe off the plug and electric outlet with a dry, soft cloth to prevent electric shock or fire.
- **Do not use a faulty or loose electric outlet or cord.**
Doing so may result in a short circuit, electric shock, or fire.
- **Do not throw anything flammable into the toilet.**
Doing so may result in fire, discoloration, or malfunction.
- **A grounded wire or outlet must be installed.**
Not doing so may result in malfunction or electric shock. If no grounded plug is being used, make sure to install grounded wire.
- **Do not use many appliances in one power strip.**
Doing so may result in fire or damage. Be sure to use a dry and clean outlet. Do not use a faulty or loose outlet.
- **Use potable water only. (Ground Water)**
Not doing so may cause irritation or injury to your skin. It may clog the pipe due to contaminants.
- **Do not disassemble the seat.**
Doing so may result in electric shock, injury, or malfunction.
- **Do not disassemble, repair, or modify this appliance.**
Doing so may result in electric shock, injury, or malfunction.
- **Do not obstruct the warm air dryer outlet.**
If the outlet is obstructed by any objects, it may result in fire. If the outlet is obstructed with fingers or with hands, it may result in injury.
- **Unplug when you hear beeping or smell a strange odor.**
Unplug right away and contact your dealer from whom you bought this appliance.



WARNING - MIGHT CAUSE SLIGHT INJURY OR DAMAGE. BE AWARE.

- **Be aware of low-grade burn.**
It may result in a low-grade burn if sitting on the heated seat for a long time. Be aware of being used for the following: children, senior citizens, patients, people who cannot control the temperature, people who are not sober, or tired people. If injured in a low-grade burn, see a doctor immediately.
- **Do not step on or place heavy objects on this appliance.**
Doing so may damage the unit. Do not step on the lid, seat, or control panel to avoid injury or product damage.
- **Unplug while not using over an extended period of time.**
- **Unplug when there is thunder or lightning.**
- **Use this appliance on a toilet only.**
Not doing so may result in fire or electric shock.
- **Do not use force to pull out the water hose.**
Doing so may cause water leakage.
- **Be aware of urine splash on a nozzle or warm air dryer outlet.**
Not doing so may result in malodor or failure.
- **Do not use force to close the lid.**
Doing so may cause malfunction. Be aware not to put fingers between the lid and seat when you close the toilet. It may cause injury.
- **Unplug when cleaning.**
Not doing so may result in fire or electric shock.
- **Use low temperature for children and handicapped.**
If the temperature is too high, it may result in a burn if they fail to recognize the temperature.
- **Do not sit or lean against the lid or the control panel.**
Doing so may cause malfunction or breakage. Applying excessive force may damage the lid or components that may lead to injury.
- **Do not put a vase cup or small materials on this appliance.**
Doing so may result in fire or electric shock.

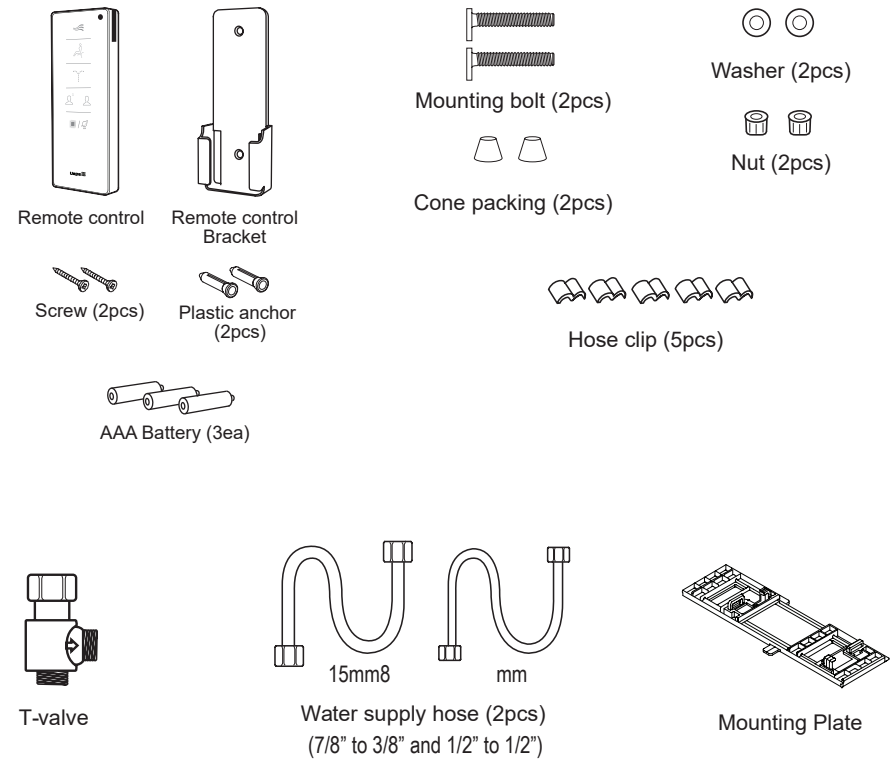
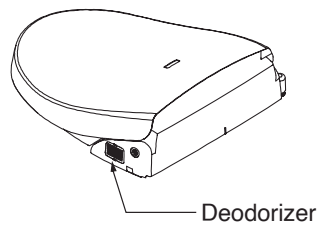
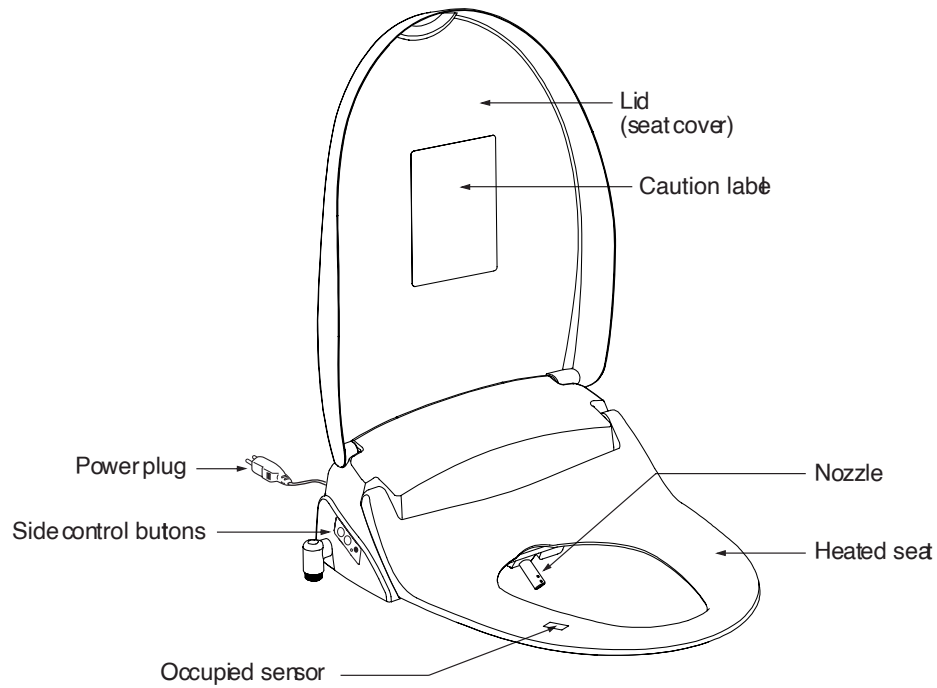



If electric work is needed, please contact a qualified electrician or serviceman only.

Remove the Existing Toilet Lid and Seat

1. Remove the nuts, washers, and cone packings from the toilet seat and mounting bolts in the back of the toilet.
2. Remove the toilet seat, lid, and mounting bolts.
3. Keep them in case you need them.

Toilet Size (Elongated)

The toilet dimensions must be within those shown on the right. Do not install this appliance on a toilet that does not meet these dimensional requirements.

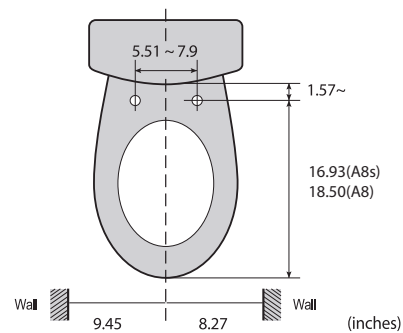

Occupied Sensor

1. This appliance is equipped with an occupied sensor.
2. The unit will not work unless the seat is occupied.

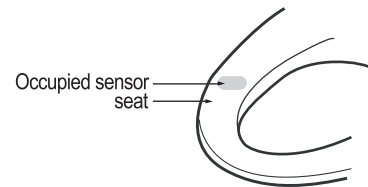

Mounting the Plate

Place the mounting plate over each mounting hole. Insert the mounting bolts through the plate and mounting holes. Slide cone packings and washers onto the bolts and fasten tightly with nuts.

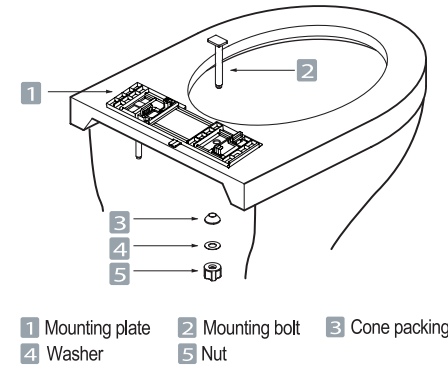



Connecting the Water Hose

Using Inline Carbon Filter - The use of an external inline carbon water filter is not required unless the unit is used in an area with extreme hard water. If a carbon filter is used, the filter must be replaced every 6 months. Inline carbon filters can be purchased from any authorized Bio Bidet reseller.

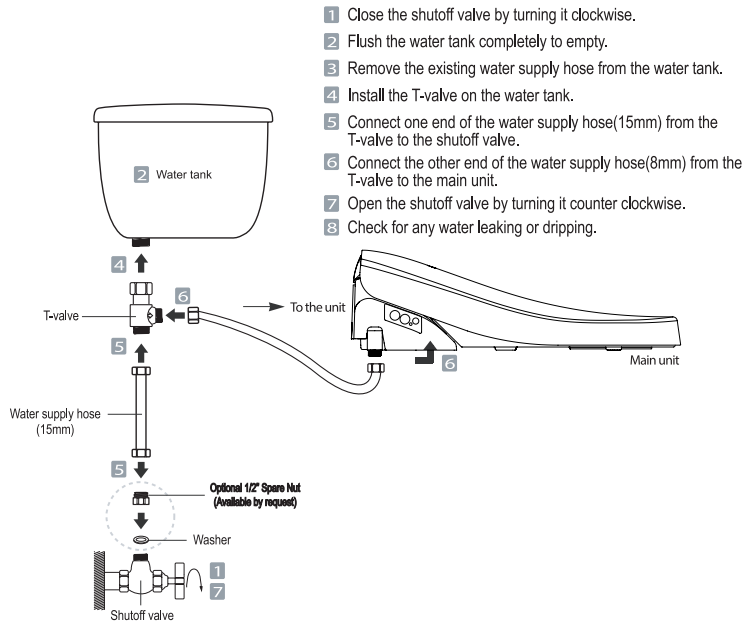

* Shutoff valve sizes may vary. If supplied parts do not fit, please call 877-339-5214

This product was designed and intended for use exclusively with Bio Bidet USPA water filters. The purchase or use of any other water filter is not the responsibility of BBC Innovation LLC. As such, any use of non USPA water filters is prohibited and will void the warranty for those Bio Bidet products. Bio Bidet will not be responsible for any resulting damages or claims related to the misuse or distribution of non Bio Bidet USPA filters.

How To Attach the Unit

1. Use the tab on the mounting plate and align it with the track on the seat, for a proper fit.
2. While pressing the side button, lower the seat onto the mounting plate.

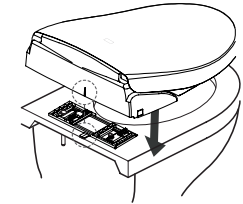

How To Detach the Unit

1. While pressing the side button, pull the seat up and separate it from the toilet bowl.

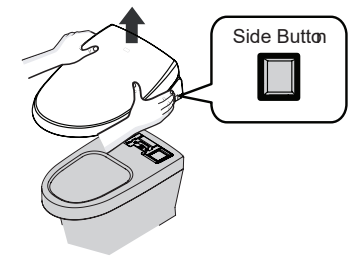



Trial Operation

1. **Preparation**

Plug the power cord into the outlet, and then the water tank will be filled in 2 minutes.

2. **Checking All Functions**

Cover the toilet bowl using the sheet of plastic wrap on the unit to prevent the washing water from being sprayed out of the toilet. Then check for all functions described in this manual.

3. **There are possibilities of water coming out that remains in the unit while heating.**

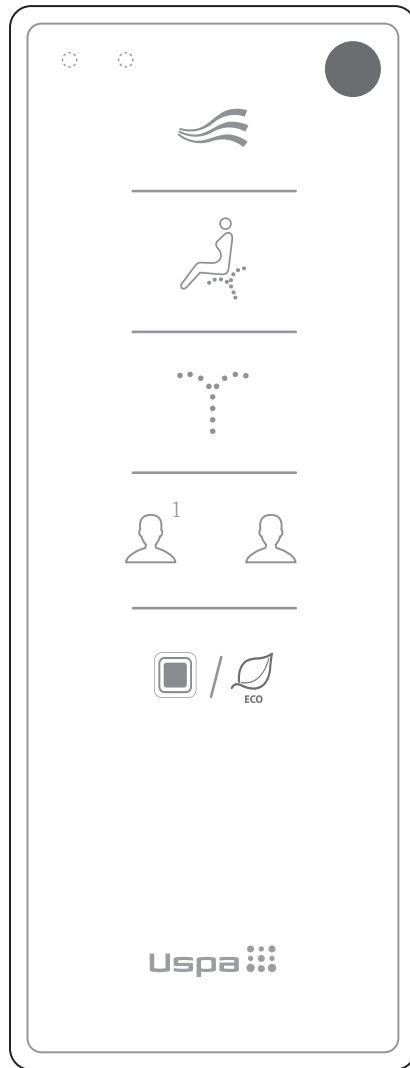

FRONT

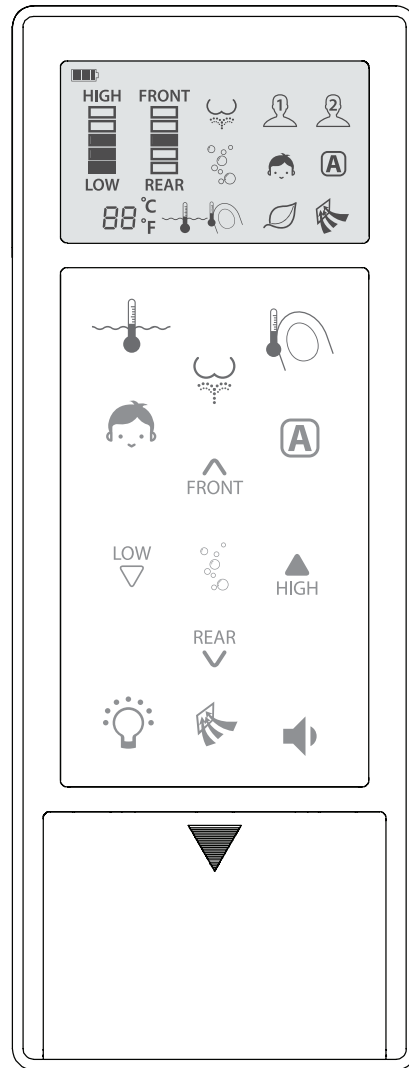

BACK

Dry

- Press “Dry” Warm air will come out for 3 minutes.
- To alter the strength of drying, press the button again.
- Dry temperature can be adjusted by pressing LOW or HIGH button to 5 levels.

Cleansing

- Press “Cleansing” to clean your posterior. The function will stop in 2 minutes automatically.
- Press this button again to activate oscillation. The nozzle moves back and forth automatically to widen the cleansing area.
- Oscillation wash stops if this button is pressed again.

Bidet

- Press “Bidet” for feminine wash. The function will stop in 2 minutes automatically.
- Press this button again to activate rhythmical wash for the massage effect.
- Massage wash stops if this button is pressed again.

Stop



- Press “Stop” to stop the current operation.
- When a user stands up, all operations will stop automatically. (Except for kids function)

Eco

- Press “Eco” for 2 seconds to activate the power-saving mode. Seat and water temperature will be set to low but the temperature will remain at room temp.



Temperature Adjustment (Water/Seat)

- The temperature of seat and water can be adjusted by pressing  or  button.
- There are 4 levels (Room temp-Low-Medium-High)

Battery Alarm

- Change the batteries if the battery icon on LCD is flickering (LED on the front also flickers)

Massage

- Press “Massage” to activate rhythmical wash for massage effect when you are using “Cleansing” or “Bidet”.
- Press the button again to release this function.

Kids

- Press “Kids” to change all functions to be suitable for children. It will automatically operate from cleansing (2 min) to dry (3 min) with adequate water pressure and nozzle position.
- This unit should be used under the supervision of an adult.

Auto

- Press “Auto” during the operation of “Cleansing”, Cleansing wash (20 sec) - Oscillating wash (20 sec) - Massage (80 sec) - Dry (3 min) will operate.

Nozzle Position

- Nozzle position can be adjusted by pressing FRONT or REAR button to 5 levels.
- Nozzle position will remain.

Water Pressure (Cleansing/Bidet)

- Water spray pressure can be adjusted by pressing LOW or HIGH button to 5 levels.
- Water pressure level will remain.

Aerated Spray

- This gentle but strong spray cleanses better while using “Cleansing”, “Bidet” or “Kids”.
- The aerated spray is released if this button is pressed again.

LED

- Press the button to activate the light on/off.
- Delicate light will help the user to use the toilet without turning the bathroom lights on during night time.

Deodorization

- When the appliance is in use, the deodorizer will work a maximum of 20 minutes automatically.
- When a user stands up, the function stops after 1 minute.

Sound

- Press the button to enable the beeping sound.
- To disable, press the button again.



User Setting

- Each button can save 2 settings. (Cleansing, Bidet)
- Press the User 1 button and Cleansing or Bidet consecutively. Then choose nozzle position by pressing the FRONT/REAR button and water pressure level by pressing the LOW/HIGH button. Press User 1 again to save the setting with a beep.
- The same applies to saving the User 2 setting.
- Press User 1 or User 2 while using cleansing or bidet to operate saved settings.

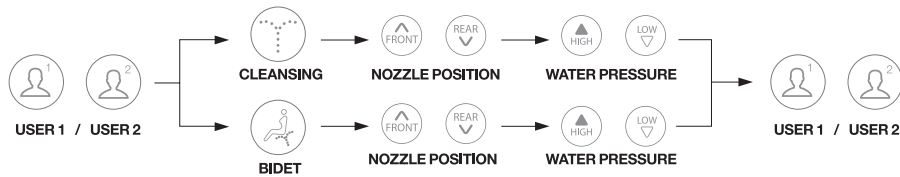

Side Control Buttons

- Use side control buttons on the unit when the remote control is broken or its batteries are dead.
- Press “cleansing” or “Bidet” to start.
- Press again to stop. Do not use sharp items to press the buttons.

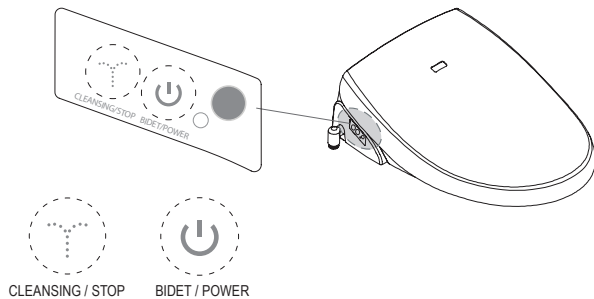

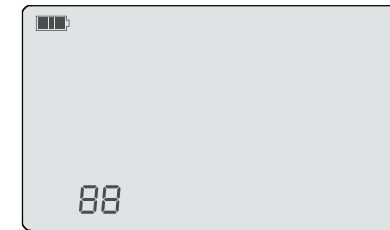

Identification

- This function is useful for public toilets when more than one unit of this product is installed.
- To prevent interference among units, the main unit and the remote control should be set with the same ID.
- If there is only one unit in the bathroom, you do not need to set an ID.
- The initial ID of the remote and main unit is “0”.
- There are 16 choices in ID (00-15).



How to Set ID (Remote Control)

- Press the “High”  button for 3 seconds and the ID will show up on display.
- Press the “High”  or “Low”  button until your ID appears on display. (00-15)
- Press “Stop” to save the ID.



Set the Unit

- Unplug the unit and then plug it back in.
- Push the power bidet button on the side of the unit to turn the unit off.
- Push the button again and this time hold it down. (It should turn on when you do this).
- While holding that button down, push the stop button on the remote for 2 seconds.

NOTE

- If ID's of the remote control and the main unit are different, the main unit will not work.
- Make sure the remote control and the main unit are set with the same ID.
- ID will remain even if the power is unplugged or the batteries of the remote control are replaced.

CAUTION: Do not forcefully push, pull, or bend the nozzles. It may result in failure. Make sure to use the “Stop” button on the remote control.

NOZZLE CLEANING

Manual Cleaning

1. Make sure the occupied sensor is not activated. (Do not sit on the seat or place hands on the seat sensor.)
2. Press Front ^{FRONT} button for 2 seconds to extract the bidet nozzle.
3. Use a toothbrush or soft cloth to clean the nozzle.
4. Press the Stop button to retract the nozzle.



Auto Cleaning

1. Press Rear ^{REAR} button for 2 seconds to start auto cleaning. The nozzle will be cleaned for 30 seconds and returned automatically.
2. Press the Stop button while cleaning to retract the nozzle.
3. Do not force to push or pull the nozzles while cleaning.



Strainer Maintenance

- This appliance will not operate properly if the strainer is clogged. Be sure to clean the strainer regularly.

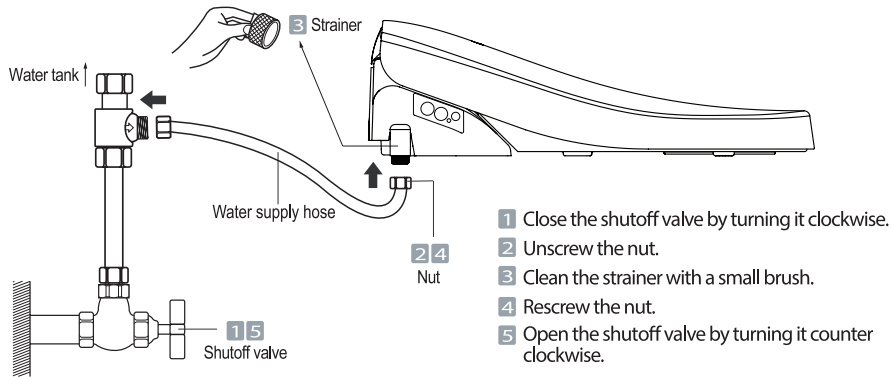

Cleaning The Body

1. Regularly wipe off the body with a dry soft cloth, sponge, or wash with a damp cloth and mild detergent.
2. For care of the plastic body, do not use any cleansers such as: toilet cleansers, home cleansers, bleach, benzene, paint thinner, cresol, etc.



Draining Water - while not using over extended period of time.

1. Unplug the Power Supply Cord.

- Not doing so may cause a fire.

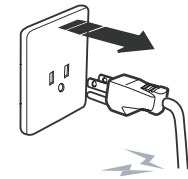

2. Close the Shutoff Valve.

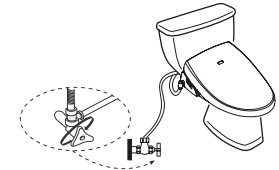

3. Unit Separation

- While pressing the detach button, pull the unit forward and separate it from the toilet bowl.



4. Drain Bolts

- Uphold the appliance and thoroughly drain the water by unscrewing the drain bolt. Beware of losing the drain bolt
- The following figure is only to check the location of the 'Drain Bolt'. To prevent malfunction, do not place in vertical position or tilt the product.

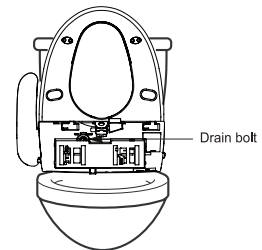



5. Screw the Drain Bolt and Install the Appliance

- Refer to the trial operation method to use this appliance again.

Prevent Freezing

1. **Make sure the power cord is plugged in properly.**
2. **Set the temperature of water to low or middle.**
(Freezing can be prevented by thermal efficiency of the water tank.)
 If there is no heating system in the toilet, wrap pipes with cloth or other materials.
3. **If you are not using the unit for a long time in the winter, unplug and drain the water from the water tank and pipes thoroughly.**
 Refer to the water drain method.

PROBLEM	POSSIBLE CAUSE	POSSIBLE SOLUTION
Completely fails to work	Is there a power outage? Is the power cord unplugged? Are you sitting on the seat correctly?	<ul style="list-style-type: none"> • Check for the power cord failure or a tripped breaker. • Plug the power cord in properly. • Sit on the seat completely.
Water does not spray	Is the water shutoff valve closed? Is the strainer clogged? Are the nozzles clogged? Is the water purifying filter clogged?	<ul style="list-style-type: none"> • Check for any water leaking or dripping. • Clean the strainer. • Clean the nozzles. • Change the water purifying filter.
Water is leaking or dripping	Are all the hoses tightened up properly?	<ul style="list-style-type: none"> • If water is still leaking or dripping, contact to your dealer.
Seat, water, or air is not warm enough	Is the temperature set to OFF? Is the appliance used in Eco mode during the cold weather?	<ul style="list-style-type: none"> • Reset the temperature. • Press "eco" again to release the function.



ITEM		A8	A8s
Standard power supply		AC 120V 60Hz 1248W	
Water Supply	Way of connection	Direct connection to tap water	
	Water pressure	0.07 MPa - 0.74 MPa	
Cleansing	Spray for cleansing	700 (±150) ml/min	
	Spray for bidet	700 (±150) ml/min	
	Water capacity	740 ml	
	Spray temperature	Room temp - 39°C (102°F)	
	Heater capacity	1200W	
	Safety feature	Thermal switch, temperature fuse, floating switch	
Dry	Air temperature	Room temp - 60°C (140°F)	
	Heater capacity	250W	
	Safety feature	Temperature fuse	
Heated Seat	Seat temperature	Room temp - 39°C (102°F)	
	Heater capacity	48W	
	Safety feature	Temperature fuse	
Deodorization method		Catalytic filter	
Circuit breaker		Within 15mA 0.03 seconds	
Length of the power cord		1.2m	
Dimensions		(W) 410mm x (L) 520 mm x (H) 160 mm	(W) 410 mm x (L) 488mm x (H) 160mm
		(W) 16.14 inches x (L) 20.79 inches x (H) 6.30 inches	(W) 16.14 inches x (L) 19.21 inches x (H) 6.30 inches
Weight		4.0 Kg (8.8 lbs)	3.9 Kg (8.6lbs)

- Recommended water supply pressure is 0.1 - 0.69 MPa.
- The minimum available water supply pressure is 0.07 MPa, however 0.1 MPa pressure, water spray pressure might not be adequate.

USPA Personal Hygiene Appliance Limited Warranty

We warrant our products to be free from manufacturing defects under normal use and service for a period of three (3) years from the date of your purchase. 100% Coverage of all parts and labor for the entire product for the first year from the original date of purchase. This warranty is only valid within the United States and Canada.

Our obligation to you under this warranty is limited to repair or replacement, at our option, of defective products or parts, provided that the products were properly installed and used in accordance with instructions. We reserve the right to make inspections in order to determine the cause of the defect. We will not charge for labor or parts in connection with warranty repairs or replacement. We are not responsible for the cost of removal, return, and/or reinstallation of products.

This limited warranty does not apply to:

- Damage or loss from fire, earthquake, flood, storm, etc.
- Damage or loss resulting from any unreasonable use, abuse negligence, or improper maintenance.
- Damage or loss from improper installation, removal, repair, or modification.
- Damage or loss resulting from sediment or other matters contained in your water system.

This warranty gives you specific legal rights. For warranty or service information, please contact your dealer where you bought this appliance or us. Only the original purchaser may submit a claim under this limited warranty.

This limited warranty is our only warranty covering your product. Repair or replacement as provided under this warranty shall be the exclusive remedy available to you. We shall not be responsible for loss of the product or for other incidental, or consequential damage or expenses you may incur or for labor or other costs due to installation or removal, or cost of repairs by others, or for any other expense not specifically stated above. Except to the extent prohibited by applicable law, any implied warranties including that



of merchantability or fitness for use, are expressly limited to the duration of this warranty.

Warning!

We are not responsible or liable for any failure of, or damage to, this plumbing product component caused by in-tank bowl cleaners containing chlorine (calcium hypochlorite).

Note:

The use of a high concentration of chlorine related products can seriously damage the fittings. This damage can cause leakage and serious property damage.

For more information, please contact your dealer or us.

BBC INNOVATION LLC

7900 S RT 31 Crystal Lake IL 60014

T: 847-458-2334

F: 847-854-1296

support@biobidet.com

<http://www.biobidet.com>

Thank You



Technical Support/Customer Service
7900 S Route 31 Crystal Lake, IL 60014
T: 847.458.2334
U.S. TOLL FREE: 877.339.5214

support@biobidet.com
www.biobidet.com