

ALPHA

— B I D E T —

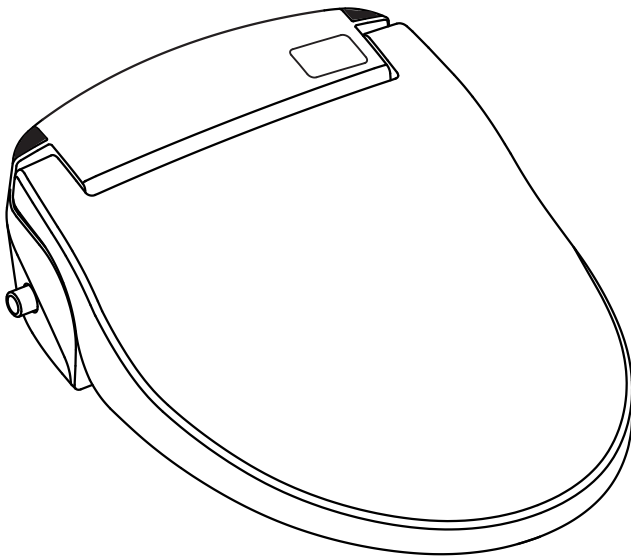

MODEL NUMBER

JX-EW (Elongated)

JX-RW (Round)

NOTES

- ▶ This product was manufactured for household use only.
- ▶ Read all operating instructions before installation and use.
- ▶ Please save this operating instruction manual and place in an easily accessible location.
- ▶ Due to ongoing product improvements, external appearance and specifications are subject to change without notice.

CONTENTS

Important Safeguards	02
Grounding Instructions	04
Parts Identification	05
Basic Instructions	08
Functions and Operation	09
Installing Unit	13
Trial Operation	17
Uninstalling Unit	18
Maintenance	19
Draining Water Tank (Reservoir)	21
Troubleshooting	22
Product Specifications	23
Product Registration	24

IMPORTANT SAFEGUARDS

READ ALL INSTRUCTIONS BEFORE USING.

DANGER To reduce the risk of electrocution.

- Do not use while bathing.
- Do not place or store product where it can fall or be pulled into a tub or sink.
- Do not place in or drop into water or other liquid.
- Do not reach for a product that has fallen into water. Unplug immediately.

WARNING To reduce the risk of burns, electrocution, fire or injury to persons.

- Close supervision is necessary when this product is used by, on, or near children or invalids.
- Use this product only for its intended use as described in this manual. Do not use any attachments unless recommended by the manufacturer.
- Never operate this product if it has a damaged cord or plug, if it is not working properly, if it has been dropped or damaged, or dropped into water. Return the product to a service center for examination and repair.
- Keep the cord away from heated surfaces.
- Never block the air openings of the product or place it on a soft surface, such as a bed or couch, where the air openings may be blocked. Keep the air openings free of lint, hair, and the like.
- Never use while sleeping or drowsy.
- Never drop or insert any object into any opening or hose.
- Do not use outdoors. or operate where aerosol(spray) products are being used or were oxygen is being administered.
- Connect this product to a properly grounded outlet only. See Grounding Instructions.
- Any other servicing should be performed by an authorized service representative.
- Do not dismantle, repair, or alter the unit.
- Do not pour or spray water on to the unit.
- The unit must be grounded.
- Do not touch the power plug with wet hands.
- Properly connect the power cord to the electrical outlet corresponding to the rated voltage of the unit.
- Do not use damaged or loose power cord.
- Do not use steam cleaner.
- Keep the unit away from fires or inflammable substance.
- Do not connect to the industrial water supplies.
- Do not connect other electrical appliances to the same power socket connected to the unit.
- Replace damaged power code and plug by authorized service center.
- Caution against low temperature burns.
- Before removing the unit from the toilet bowl, disconnect the power plug first.

IMPORTANT SAFEGUARDS

CAUTION To reduce the risk of injury to persons or damage to the product or the property.

- **Do not place heavy objects or step on the unit.**
Doing so may cause product damage or injury.
- **When cleaning the unit, do not use any chemicals. Clean the unit with a moist, well-wrung soft cloth. For excessive stains, use a soft cloth moistened with mild dish washing detergent and wipe with a dry cloth.**
Using chemicals may cause product damage.
- **Do not slam the lid.**
Slamming the lid may cause product damage.
- **Do not lean on the lid.**
Leaning on the lid may cause product damage.
- **When not in use for a long period of time, disconnect the power plug.**
- **Do not twist or pull the connection hoses.**
Twisting or pulling may affect water supply or cause water leakage.
- **Do not cover the warm air outlet or insert hands or other objects.**
Doing so may cause burn or electric shock.
- **Do not operate the unit during product malfunction.**
Disconnect the power plug and call an authorized service provider.
Using a malfunctioning unit may cause fire or electrical shock.

SAVE THESE INSTRUCTIONS

INFORMATION TO THE USERS

This equipment has been tested and found to comply with the limits for a Class B digital device, pursuant to part 15 of the FCC Rules. These limits are designed to provide reasonable protection against harmful interference in a residential installation. This equipment generates, uses and can radiate radio frequency energy and, if not installed and used in accordance with the instructions, may cause harmful interference to radio communications. However, there is no guarantee that interference will not occur in a particular installation. If this equipment does cause harmful interference to radio or television reception, which can be determined by turning the equipment off and on, the user is encouraged to try to correct the interference by one more of the following measures:

- Reorient or relocate the receiving antenna.
- Increase the separation between the equipment and receiver.
- Connect the equipment to an outlet on a different circuit than the receiver.
- Consult the dealer or an experienced radio/TV technician for help.

WARNING

Any changes or modifications not expressly approved by the manufacturer could void the user's authority to operate the equipment.

GROUNDING INSTRUCTIONS

GROUNDING INSTRUCTIONS

- This product should be grounded. In the event of an electrical short circuit, grounding reduces the risk of electric shock by providing an escape wire for the electric current. This product is equipped with a cord having a grounding wire with a grounding plug. The plug must be plugged into an outlet that is properly installed and grounded.

DANGER - Improper use of the grounding plug can result in a risk of electric shock.

If repair or replacement of the cord or plug is necessary, do not connect the grounding wire to either flat blade terminal. The wire with insulation having an outer surface that is green with or without yellow stripes is the grounding wire.

Check with a qualified electrician or serviceman if the grounding instructions are not completely understood, or if in doubt as to whether the product is properly grounded.

- This product is for use on a nominal 120 V circuit, and has a grounding plug that looks like the plug illustrated in Figure A. A temporary adapter, which looks like the adapter illustrated in Figure B and C, may be used to connect this plug to a 2-pole receptacle as shown in Figure B if a properly grounded outlet is not available. The temporary adapter should be used only until a properly grounded outlet (Figure A) can be installed by a qualified electrician. The green-colored rigid ear, lug, or the like, extending from the adapter must be connected to a permanent ground such as a properly grounded outlet box cover. Whenever the adapter is used, it must be held in place by the screw.
- If it is necessary to use an extension cord, use only a three-wire extension cord that has a three-blade grounding plug, and a three-slot receptacle that will accept the plug on the product. Replace or repair a damaged cord.

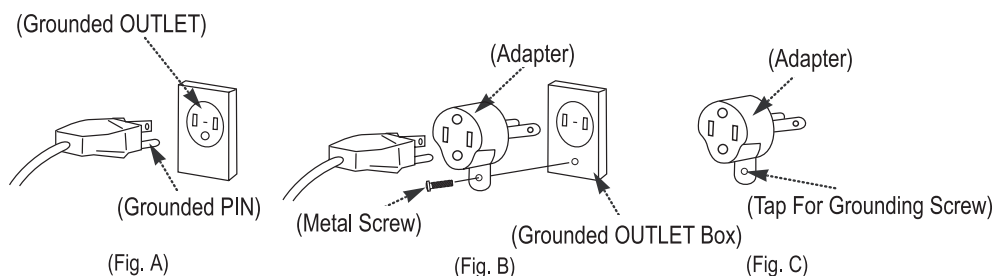

Main Unit

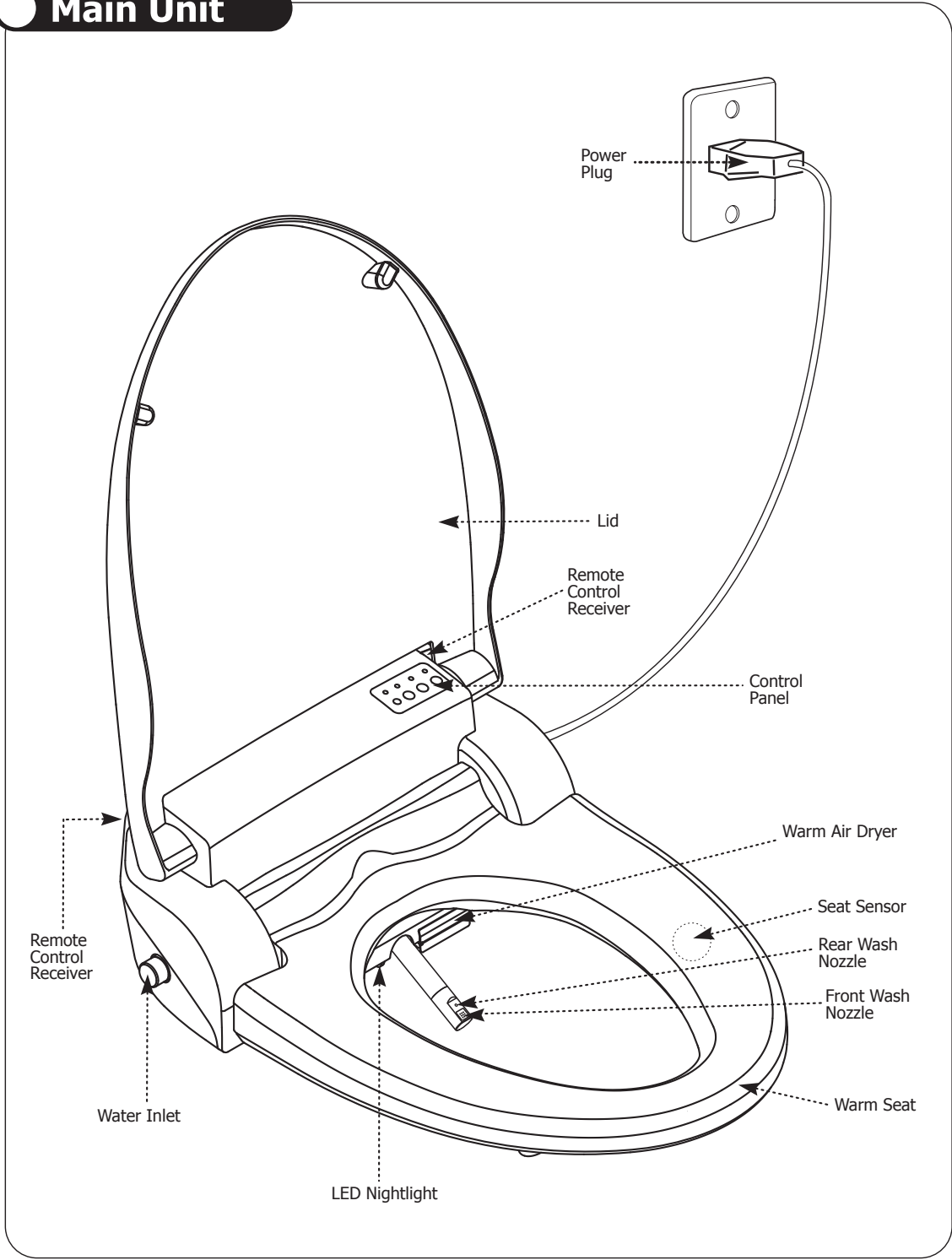

Parts Identification

Accessory Parts

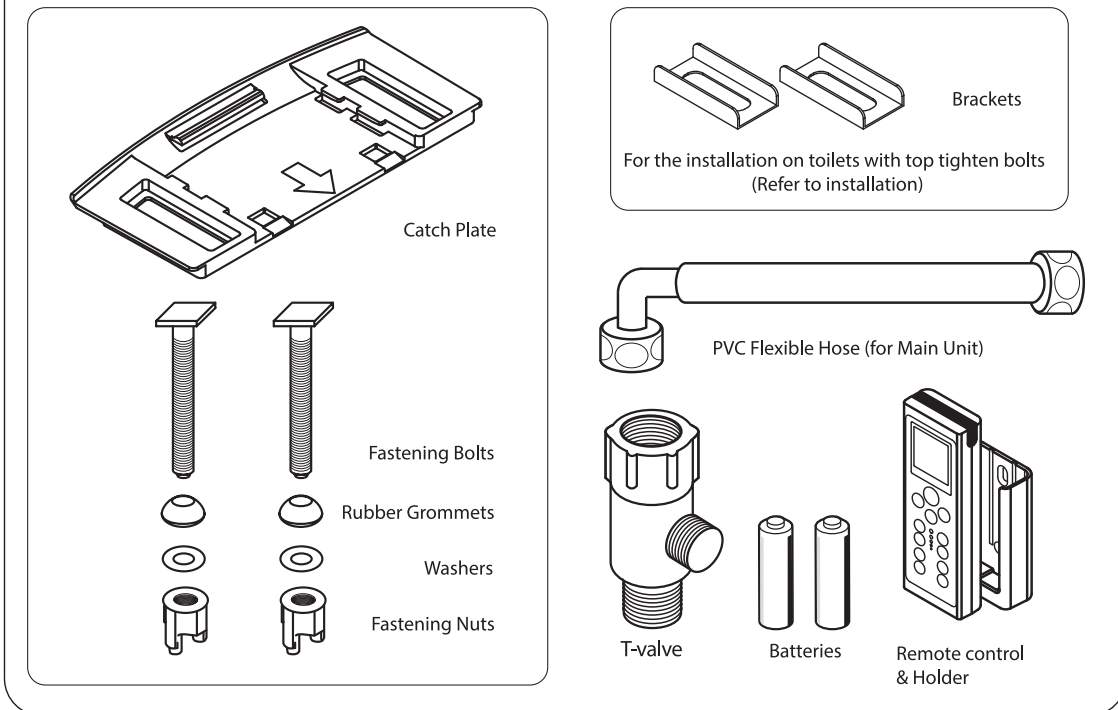

Control Panel

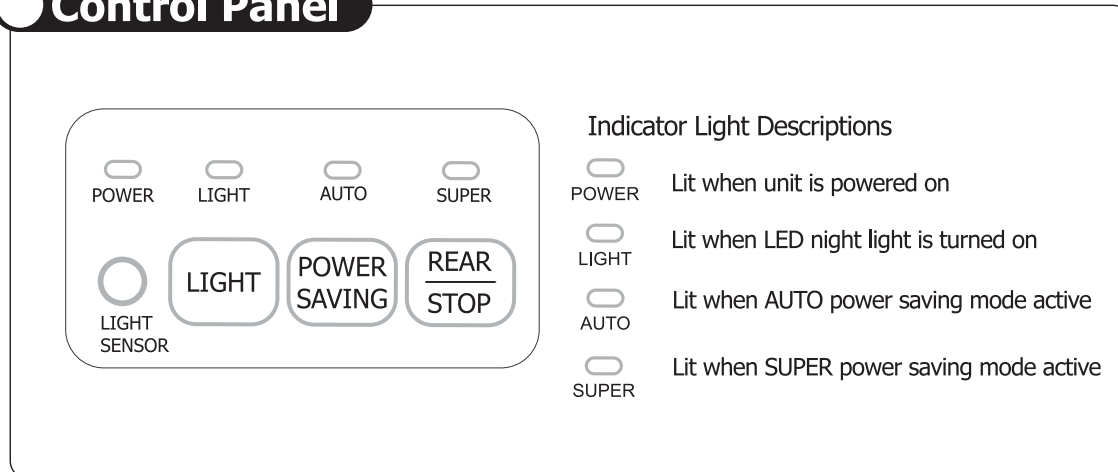









Parts Identification



Remote Control



LCD Screen Icon Descriptions

-  Appears when REAR or EASY WASH pressed
-  Appears when FRONT pressed
-  Appears when DRY pressed
-  Appears during any wash function
Number of lines displays spray pressure level
-  Appears during dry function
Number of lines displays dryer temp
-  Displays current water temperature level
-  Displays current seat temperature level
-   Both appear when WASH+DRY pressed

Special Function Button Descriptions

-  Activates a 1 minute rear wash cycle, and then a 1 minute dry cycle and then stops
-  Activates a high pressure rear wash with nozzle oscillation

Basic Instructions

1 Sit on the seat

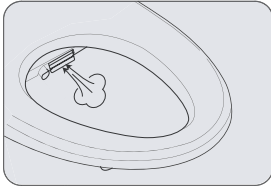

- When you sit on the seat, a beep will sound and you will hear water dripping into the bowl. This is the nozzle's self-cleaning function.

2 Press the REAR or FRONT button

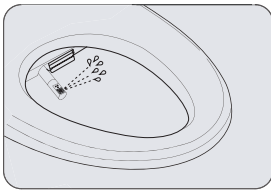

- Each wash function will automatically stop after 1 minute.
- The nozzle will oscillate back and forth if you press the same wash button again during the wash.
- Unit will beep once the wash cycle completes.

3 Press the DRY button

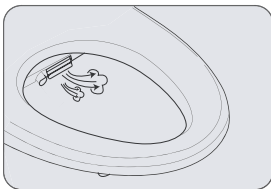

- Warm air dryer function will automatically stop after 3 minutes.
- Dryer is much more effective if you dab away excess moisture with toilet paper first.
- Unit will beep once the dry cycle completes.

4 Press the STOP button

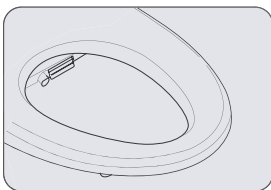

- Stops all functions currently in operation.

- When using the unit, please center your weight on the bidet seat.
- The seat sensor is installed inside the seat. (Please refer to pages 5 or 6.) The unit starts operating only when the user's skin touches the seat sensor. **Seat covers or other materials on the seat may prevent the sensor from operating properly.**

Functions & Operation

Nozzle Oscillation

- Nozzle will begin oscillating back and forth by pressing REAR or FRONT during wash cycle.
- Nozzle will stop oscillating by pressing REAR or FRONT again.

Water Pressure Adjustment

- Water spray pressure can be adjusted by pressing the HI or LO buttons.
- The unit remembers the most recent water pressure setting.

Nozzle Position Adjustment

- During a wash cycle, press FR to move the nozzle forward or BK to move the nozzle backwards.
- The nozzle position will reset to the middle position between users.

Water Temperature Adjustment

- Press WATER TEMP to adjust the water temperature level.
Water temperature will cycle through 4 levels: Off - Low - Med - High

Seat Temperature Adjustment

- Press SEAT TEMP to adjust the seat temperature level.
Seat temperature will cycle through 4 levels: Off - Low - Med - High

※ The unit remembers the water and seat temperature settings even if the power is shut off.
No need to readjust the temperature settings after a power failure.

Functions & Operation

Air Dryer Temperature Adjustment

- Press HI or LO buttons during warm air drying cycle to adjust the temperature of the warm air (Levels 1-5). The unit will remember the most recent dryer temperature setting.

LED Nightlight

- Press the LIGHT button on the unit's control panel (not the remote control) to activate the LED nightlight feature. The LIGHT indicator light on the control panel will turn on when the feature is activated.
- The LED nightlight will only glow when bathroom lighting conditions are dark. You can test by covering the LIGHT SENSOR on the control panel with your finger.
- LED lights use very little energy to operate. The LED nightlight can be turned off by pressing LIGHT again.

Auto Power Saving

- Press the POWER SAVING button on the control panel until the AUTO indicator light is lit.
- When set to AUTO power saving mode, the bidet will reduce the water and seat temperature to 86F during periods of non-use.
- When someone sits down, water and seat temperature will return to the user's settings on the remote control.
- To turn off AUTO power saving mode, press the POWER SAVING button until the AUTO indicator light turns off.

Super Power Saving

- Press the POWER SAVING button on the control panel until the SUPER indicator light is lit.
- Use SUPER power saving mode for the most energy efficiency. In this mode, the seat will reduce water and seat temperatures to room temperature when lighting conditions are dark.
- Once the bathroom lights are turned on, water and seat temperature settings will return to the user's settings on the remote control.
- To turn off SUPER power saving mode, press the POWER SAVING button until the SUPER indicator light turns off.

Functions & Operation

Easy Wash

- Press the EASY WASH button to do a rear wash with nozzle oscillation at full pressure.
- 1 button operation for a quick and easy rear wash.

Wash & Dry

- Press WASH & DRY to activate the special auto clean and dry function. WASH & DRY will run a full rear wash cycle with oscillation, and then a full warm air drying cycle, and then stop.
- Default settings are "Level 3" for water pressure, "Level 2" for warm air drying temperature, and "Level 3" for the nozzle position. These settings can be adjusted during operation.
- A beep will sound when the WASH & DRY function is finished.
- Water pressure, air drying temperature, and nozzle position will return to user settings after WASH + DRY function is finished.
- The WASH & DRY function is perfect for individuals with limited mobility, children, or the elderly who may find it difficult to select custom settings on the remote control.

Power On/Off

- To turn the unit off, press the REAR/STOP button on the control panel for at least 5 seconds.
- To turn the unit on, press any button on the control panel or any wash function on the remote control. The power indicator light will turn on.
- When the unit is powered off, the remote control will remember all of the user settings.

Cleaning the Nozzle

- Press the REAR/STOP and POWER SAVING buttons on the control panel simultaneously and hold for at least 5 seconds. Be sure to press both buttons down firmly and hold.
- Clean the nozzle tip with a soft brush (i.e. toothbrush) and water. The tip can also be removed from the nozzle assembly by holding the nozzle base with one hand, while pulling off the tip with the other hand.
- Press the REAR/STOP button to retract the nozzle. The nozzle will then run through a self-cleaning function.

Functions & Operation

Burn Protection System

- When the seat temperature is set to "HI," it will be reduced automatically when the unit is in use for more than 30 minutes. This protects the user from burns, which can occur when sitting on the unit for a long time.
- Seat temperature can be returned to "HI" by manually resetting temperature or moving away from the seat.

Self-Cleaning Nozzle

- Before and after each operation, the self-cleaning nozzle function will sanitize the nozzle head.

Changing Batteries of Remote Control (AA)

- When the "BATTERY SIGN" indicator blinks on and off, remote buttons will not work properly and it is time to replace the batteries. However, the batteries may discharge quickly under certain operating conditions, such that the remote control unit may be disabled before the user notices the "BATTERY SIGN" indicator is blinking.
1. Remove remote control from the remote control holder.
 2. Open the battery cover and replace batteries with new ones. (Battery life is about 1 year.)
 3. Close the battery cover and insert remote control back into the remote control holder.

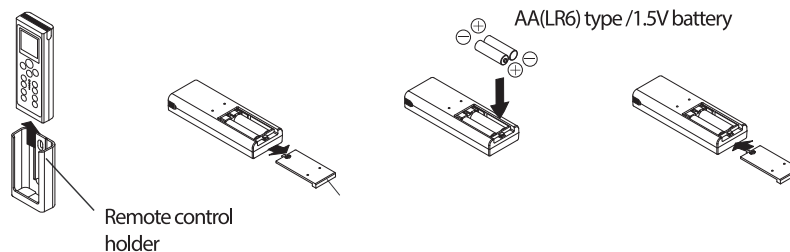

⚠ Caution

- Use only AA(LR6) /1.5V batteries. There is a risk of explosion if battery is replaced with the wrong type. Dispose of used batteries properly according to battery manufacturers instructions.
- Insert the batteries according to the (+), (-) indications marked on the remote control.
- Do not use the used battery and new one together.

Installing Unit



Caution before installation!

- Make sure the size and shape of the bidet seat are compatible with the toilet.
- Check that all parts are included and ready for installation.
- Do not connect the power until installation is complete.
- The bidet should be connected to ground by an authorized service representative only.

1 Remove the existing toilet seat.

- Remove the existing toilet seat and lid by removing the fastening nuts from below. Some toilet seats may be held in by screws from the top.
- Keep the detached seat, lid, and nuts for later use.

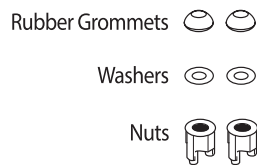

2 Shut off the water supply by turning off the shut-off valve at the wall. Then, drain the toilet tank by flushing the toilet tank completely.

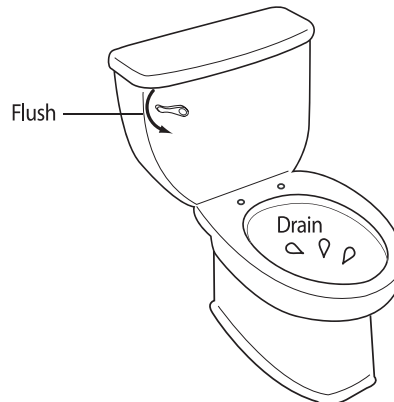
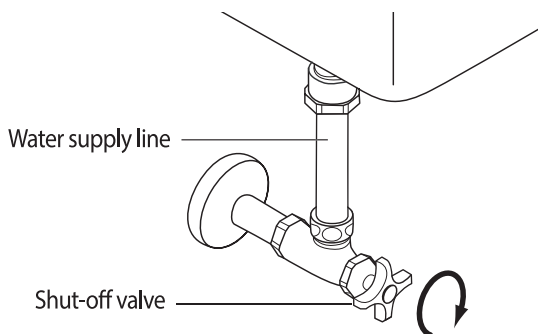

Installing Unit

- 3** Disconnect the water supply line from the toilet water tank and install a T-valve.

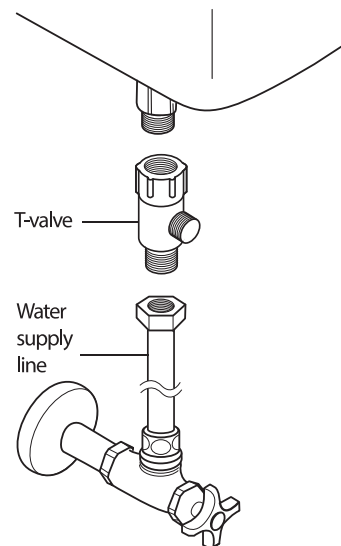

- 4** Line up the bolt slots in the catch plate with the bolt holes in the toilet bowl.

- 5.5" (140mm) hole spacing is required for a typical installation.
- If your bolt hole spacing is different, a custom solution is needed to affix catch plate bracket to toilet. Contact us for additional details.

- 5** Insert fastening bolts through the bolt slots and into the bolt holes in the toilet.

- 6** Securely fasten the catch plate by installing the rubber grommets and washers as shown below, and tightening the fastening bolts and nuts.

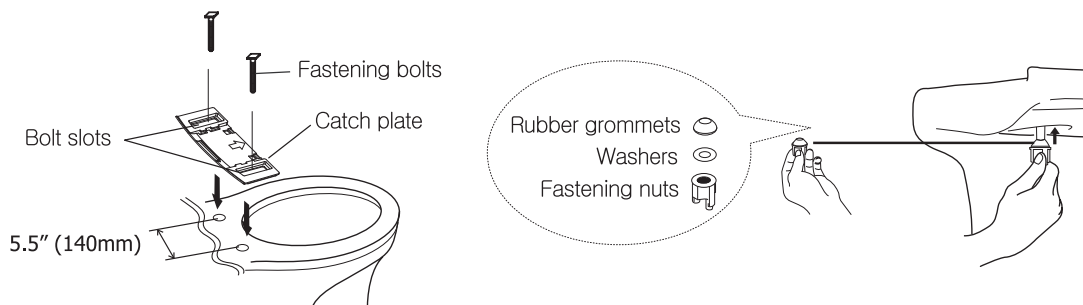

Installing Unit

Toilets with Bolts Tightened from Above

Reuse the mounting bolts from the existing toilet seat with the brackets included with the bidet.

- 4 Place the catch plate so that the slots align with the bolt holes in the toilet.
- 5 Place the brackets on the catch plate.
- 6 Fasten the catch plate using the bolts removed from the existing toilet seat.

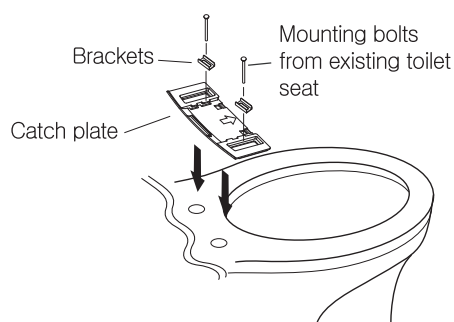

- 7 Connect the flexible hose to the bidet.

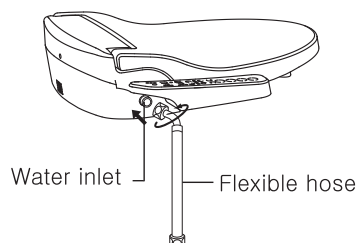

- 8 Slide the bidet unit onto the catch plate by aligning the grooves under the bidet unit.

The bidet seat should slide all the way back and lock into the mounting bracket. It should not be able to slide forward once locked.

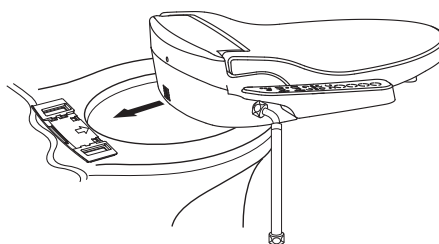

- 9 Connect the flexible hose to the T-valve

If you choose to install a water filter, install it between the t-valve and the supply hose.

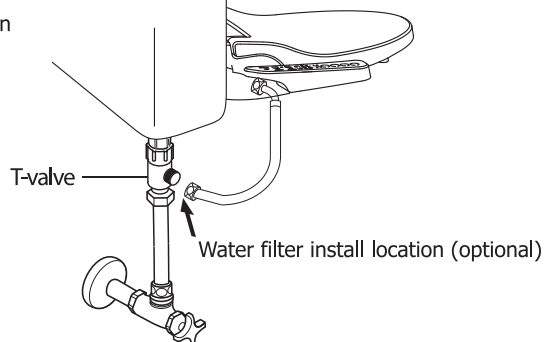

Installing Unit

Remote Control Wall Mount

- 10** Attach the remote control mounting plate to the wall with double-sided adhesive tape.

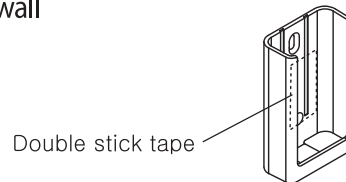

- 11** Insert batteries into the remote control unit, as shown below, and mount the unit to the mounting plate.

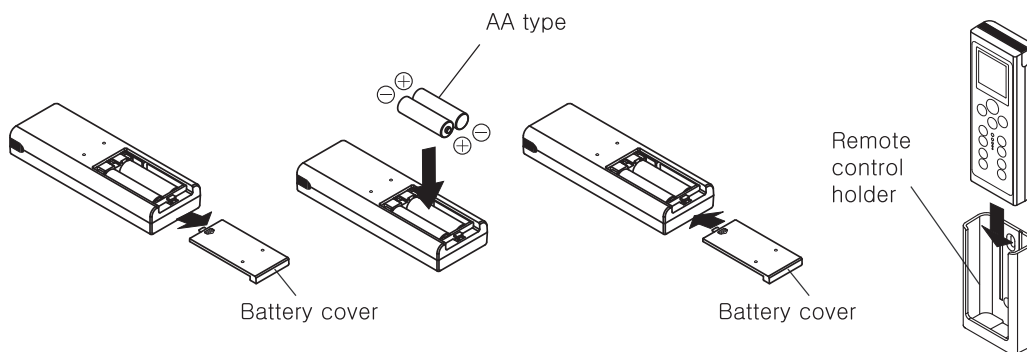

Trial Operation

- 1 Open the shut-off valve by turning counterclockwise.

- 2 Check for any water leakage from hose connections.

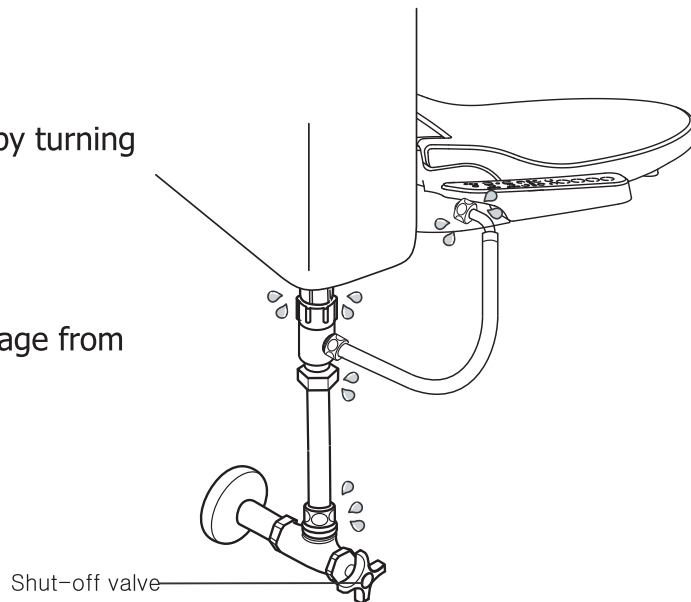

- 3 Plug in the power cord.

- If the power indicator light does not turn on after plugging in the power cord, press any button to turn it on manually.

★ **WARNING**

Do not invert or otherwise move the bidet while it is connected to power and water. Doing so may cause damage to the unit.

- 4 To test the water spray operation, press either the REAR or FRONT button while placing your hand on the seat sensor.

*Get ready to cover the nozzle with your other hand to prevent water spraying out of the bowl.

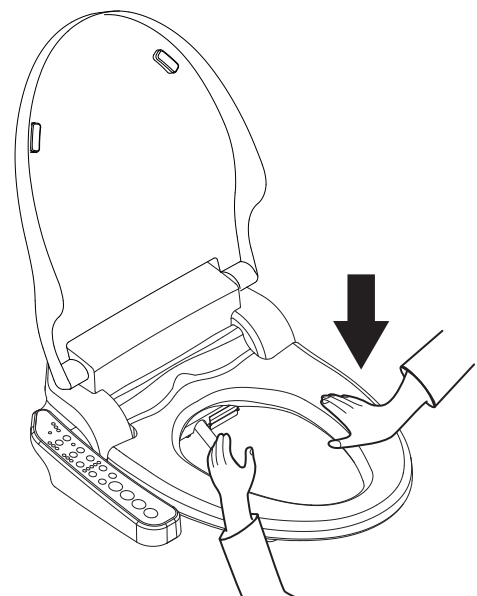

Uninstalling Unit

To detach or move the unit, follow the instructions shown below.

- 1 Unplug the power cord.
- 2 Shut off the water supply by turning the shut-off valve clockwise. Then completely drain the toilet water tank.
- 3 Disconnect the flexible hose from the T-valve, detach the bidet unit from the catch plate, and unfasten the catch plate from the toilet.

To detach the unit, pull it forward while lifting the front end, as shown.

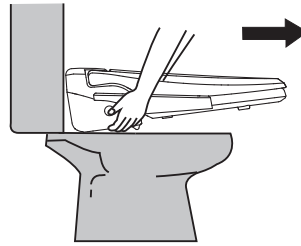

- 4 Completely drain the water reservoir by removing the drain plug from the bottom.

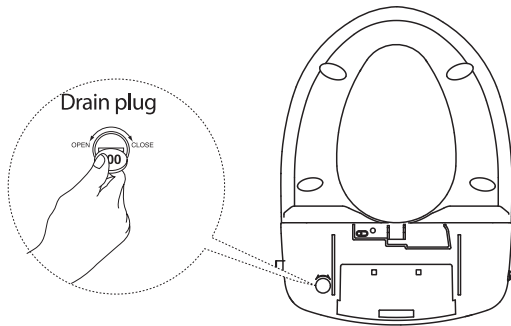

- 5 Disconnect the T-valve.
- 6 Reconnect the water supply hose to the toilet water tank.
- 7 Open the shut-off valve by turning it clockwise and then check for any leakage from connections.
- 8 Reinstall the original seat and lid onto the toilet.

For service request

Please contact the dealer where you purchased this unit or the manufacturer on the back of this manual.

Maintenance

Cleaning the Water Strainer

- 1 Shut off the water supply by turning the shut-off valve clockwise. Then drain the toilet tank by flushing completely.
- 2 Disconnect the flexible hose from the water inlet adapter on the side of the bidet.
- 3 Locate and remove the strainer from the water inlet adapter. If you can't reach it with your fingers, use thin pliers.
Clean the strainer with a toothbrush or by running it under a faucet. Then, reinstall it back into the water inlet adapter.
- 4 Re-attach the flexible hose to the water inlet adapter and open the water supply valve. Check for leaks.

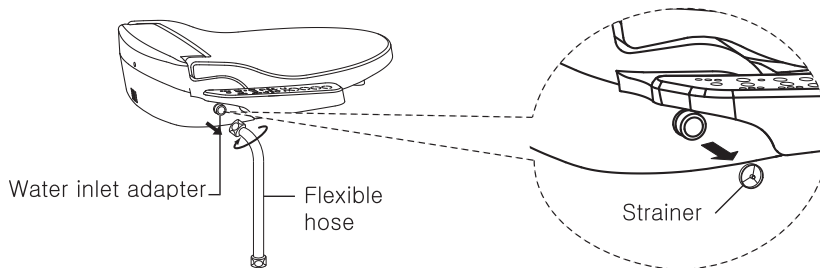

Cleaning the Nozzle

- 1 Press the REAR/STOP and POWER SAVING buttons simultaneously to extend the nozzle for manual cleaning.
- 2 Clean the nozzle manually with a soft brush. To return the nozzle to its retracted position, press REAR/STOP, which automatically activates the self-cleaning function.

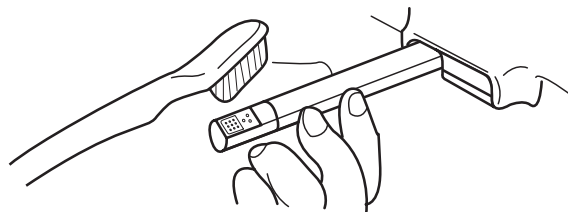

Maintenance

External Cleaning

- The bidet body is made from a durable, glossy plastic known as polypropylene. As with all glossy plastics, avoid cleaning with harsh chemicals to protect the finish.
- Avoid bleach, heavy detergents, and any alcohol or benzene based cleaners.
- Do not spray or dump excess water onto the unit. This could cause damage to sensitive internal parts.
- Ideally, clean the unit with a soft towel and a solution of warm water with mild soap or vinegar.
- If the unit is cleaned with Lysol or another abrasive chemical, be sure to wipe it down again with warm water to remove any remaining chemicals.
- Unplug the unit from power before cleaning and be careful not to splash water on the plug or socket.

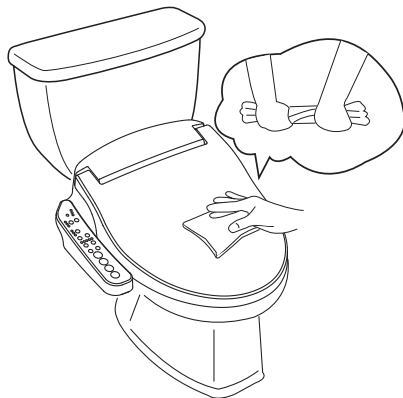

Draining Water Tank (Reservoir)

- 1 First, disconnect the power cord.
- 2 Close the shut-off valve by turning it clockwise.
- 3 Locate the drain plug on the underside of the unit. Using a coin or flat screwdriver, open the plug and completely drain the reservoir.

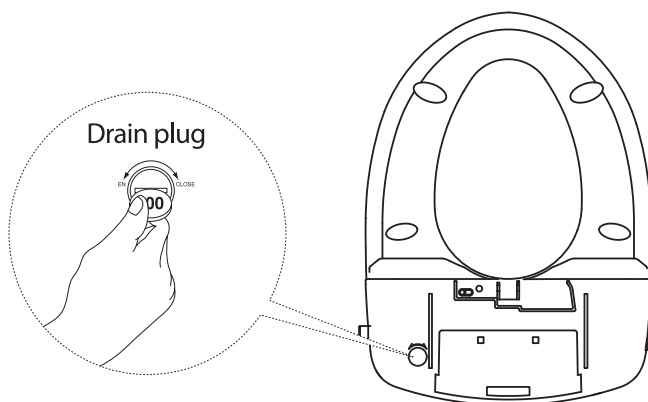
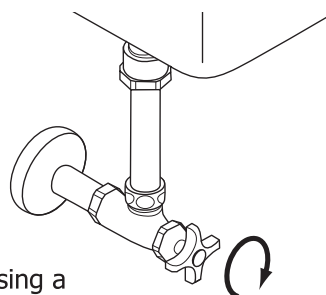

Preventing Freezing During the Winter

- 1 Confirm that the bidet is plugged in and powered on.
- 2 Set the water temperature on the remote control to low or higher. Do not set the water temperature to off.
- 3 If the bidet will not be used for an extended period of time (months), drain the water reservoir following the steps above.

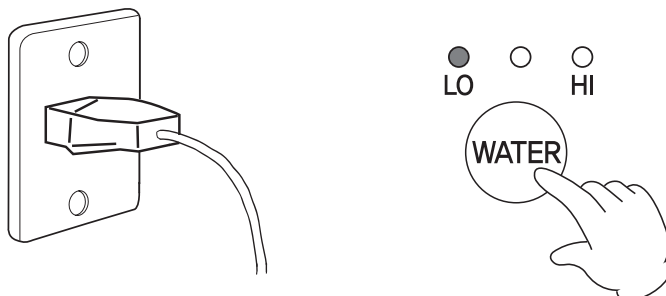

Troubleshooting

Check the following items before calling for service.

Problem Description	Possible Causes
Unit does not function at all	<ul style="list-style-type: none"> • The power is OFF. Check to see if GFCI has tripped or if outlet has power. ☞ Check by pressing any wash function button. Also check to see if power indicator LED on top of unit is lit. Test power outlet by plugging in another appliance. • The power cord is disconnected. • There is a power failure or interruption.
Rear, Front, and Dry functions do not operate	<ul style="list-style-type: none"> • The seat sensor is not engaged and active. ☞ The bidet wash and dry functions will only operate if the seat sensor detects skin contact. Check to make sure you are touching the seat sensor when seated. Seat sensor can also be engaged with a wet paper towel for testing purposes.
Remote control does not function	<ul style="list-style-type: none"> • Batteries in the remote control are depleted. • Remote control signal not reaching receiver. ☞ In some rare instances, certain bathroom setups prevent the remote control signal from bouncing off walls and reaching the receiver on the bidet unit. While this is very rare, it could be caused by factors like fluorescent lighting or shower location.
No water spray	<ul style="list-style-type: none"> • The shut-off valve is closed. • The internal water tank is not open. ☞ Unplug the unit and plug back in. Then start a wash function while seated.
Low water spray pressure	<ul style="list-style-type: none"> • The water pressure level is set to low. • The water strainer or filter is clogged.
Water temperature is low	<ul style="list-style-type: none"> • The water temperature level is switched off or set to low. Power saving modes will also reduce the water temperature.
Seat is not warm	<ul style="list-style-type: none"> • The heated seat temperature level is switched off or set to low. Power saving modes will also reduce the seat temperature.
Dryer air is not warm	<ul style="list-style-type: none"> • The warm air dryer temperature level is switched off or set to low.

Product Specifications

Item			
Power Supply		120V, 60hz	
Max. Power Consumption		1460W	
Length of Power Cord		3.94ft (1.2M)	
Water Supply Connection		Direct connection to the water supply	
Water Supply Pressure		14.3psi - 106.6psi (98 - 735kPa)	
Cleansing	Water Flow Rate	Cleansing	Max 0.185gal/min (0.7L/min)
		Bidet	Max 0.185gal/min (0.7L/min)
	Water Pressure Adjustment	3 Levels	
	Temp. Adjustment	Room Temp, 93.2F (34C), 98.6F (37C), 104F (40C)	
	Heater Capacity	1400W	
	Safety Device	Thermal Fuse, Thermostat	
Warm Seat	Temp. Adjustment	Room Temp, 89.6F (32C), 95F (35C), 100.4F (38C)	
	Heater Capacity	55W	
	Safety Device	Thermostat	
Dry	Temp. Adjustment	Room Temp - 122F (50C) (5 Levels)	
	Heater Capacity	195W	
	Safety Device	Thermal Fuse, Bi-metal	
Water Supply Temp.		37.4F (3C) - 95F (35C)	
Temp. of circumstance for use		37.4F (3C) - 104F (40C)	
Product size	Elongated	15.1" (W) x 20.8" (L) x 6" (H Rear) ~ 1.75" (H Seat) 385mm (W) x 530mm (L) x 150mm (H Rear) ~ 44mm (H Seat)	
	Round	15.1" (W) x 19.4" (L) x 6" (H Rear) ~ 1.75" (H Seat) 385mm (W) x 495mm (L) x 150mm (H Rear) ~ 44mm (H Seat)	
Product weight	Elongated	8.6lbs (3.9kg)	
	Round	8.38lbs (3.8kg)	

ALPHA BIDET

1773 W SAN BERNARDINO RD
STE B23
WEST COVINA, CA 91790

PHONE: 888.310.4511
EMAIL: support@alphabidet.com
WEB: <http://www.alphabidet.com>

ALPHA
— B I D E T —

6522-0347-00
Rev.0