

SNDOAS

RANGE HOOD Installation and Operation Manual

sndoas.service@outlook.com

Table of Contents

Warning	3
Main Parts Name	5
Opening size	5
Specifications	6
Installation Requirement	6
Installation Procedures	7-14
Operations	15
Maintenance	15
To Replace Light	16
Trouble shooting	17

Warning

1. Installation work and electric wiring (including switch location) must be done by the qualified person(s) in accordance with local applicable codes and standards, including fire-rated construction.
2. This hood may have sharp edges. Be careful to avoid cuts and abrasions during installation and cleaning.
3. The hood must be placed at a minimum distance of 28" from the cook panel.
4. Sufficient air is needed for proper combustion and exhausting of gases through the chimney to prevent back drafting. Follow the heating equipment manufacturer's guideline and safety standards such as those published by the National Fire Protection Association, and the American Society for Heating, Refrigeration and Air Conditioning Engineer (ASHRAE), and the local code authorities.
5. Ducted fans must always be vented to the outdoors.
6. This appliance is designed to be operated by adults. Children were not allowed to tamper with the controls or play with this appliance.
7. **WARNING:** To reduce the risk of fire or electric shock, do not use this fan with any solid-state speed control device.
8. When cutting or drilling into wall or ceiling, do not damage electrical wiring and other hidden cables.

WARNING : TO REDUCE THE RISK OF FIRE, USE ONLY THE METAL DUCTWORK

WARNING TO REDUCE THE RISK OF INJURY IN THE EVENT OF A RANGE TOP FIRE, OBSERVE THE FOLLOWING

1. SMOTHER FLAMES with a close-fitting lid, cookie sheet or metal tray, If the flames do not go out immediately, EVACUATE AND CALL THE FIRE DEPARTMENT.
2. NEVER PICK UP A FLAMING PAN , You may be shock.
3. DO NOT USE WATER, including wet dishcloths or towels a violent steam explosive will result
4. Use an extinguisher ONLY if:
 - You know you have a Class ABC extinguisher, and you already know how to operate it;
 - The fire is small and contained in the area where started;
 - The fire department is being called;
 - You can fight the fire with your back to an exit.

WARNING : TO REDUCE THE RISK OF A RANGE TOP GREASE FIRE:

1. Never leave surface units unattended at high settings. Boil overs cause smoking and greasy spillovers that may ignite. Heat oils slowly on low or medium settings.
2. Always turn hood ON when cooking at high heat or when flaming food.
3. Clean ventilating fans frequently. Grease should not be allowed to accumulate on fan or filter.
4. Use proper pan size. Always use cookware appropriate for the size of the element.

WARNING TO REDUCE THE RISK OF FIRE, ELECTRIC SHOCK, OR INJURY TO PERSON, KEEP IN MIND THE FOLLOWING:

1. Use this unit only in the manner intended by the manufacturer. If you have questions, contact the manufacturer.
2. Before servicing or cleaning unit, switch power off at service panel and lock the service disconnecting, to prevent power from being switch on accidentally. When service disconnecting means cannot be locked, securely fasten a prominent warning device, such as a tag, to the front panel.

Main Parts Name

Hood Body

Baffle filters

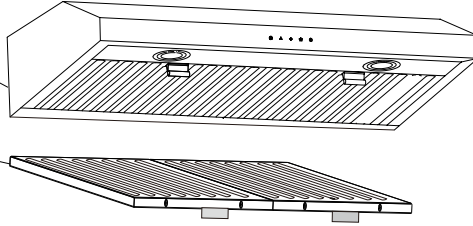

Opening Size

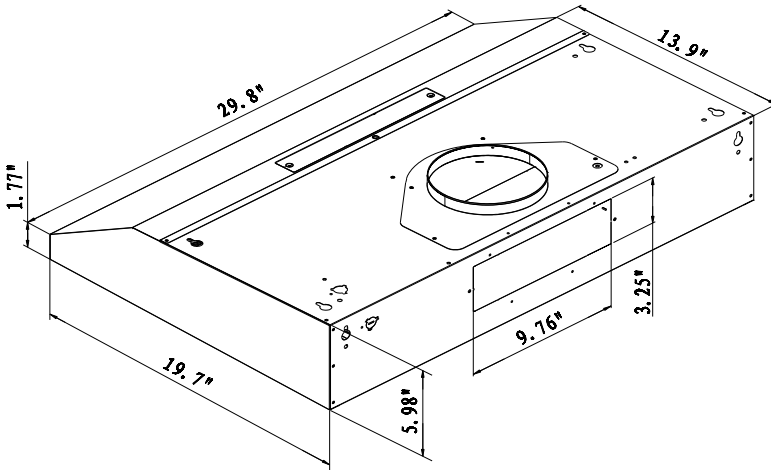
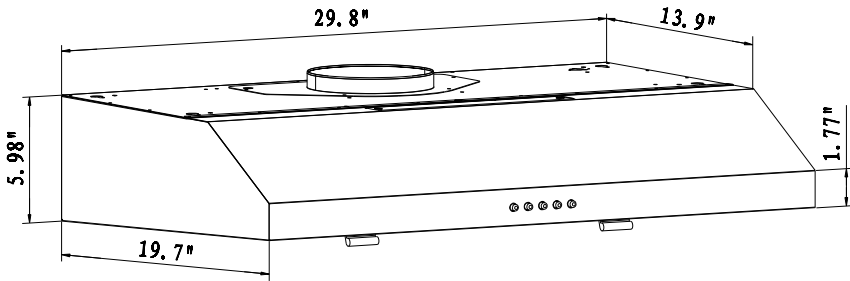

Top Vent Round Adaptor
(6")



Top & back Vent Rectangle Adaptor
(10" x 3 1/4")

Specifications:

Model :	704A/CP1(75)
Voltage:	110V-120V/60Hz
Air exit:	6" Duct
Light:	2x2W LED
Motor power:	135W
Total power:	139W
Filter:	Steel baffle filters
Control:	3 speed push button

Installation Requirement

Do not install the range hood where there are many doors or windows, to avoid effecting the exhaust efficiency of the hood cause by air convection. (Fig. 1)

Install the range hood right above the cooktop. The recommended distance between the hob and the lower edge of the range hood show as below. (Fig. 2)

In order to get the optimum performance, do not elongate the exhaust pipe too long, and try to make the curve of exhaust pipe lesser as possible, ensure the connection is airproof. (Fig. 3)

After hanging the unit on the wall, ensure the hood is leveled and vertical. (Fig. 4)

The air duct outlet must not be connected to chimney fues or combustion gas ducts. The air outlet must under no circumstances be connected to ventilation ducts for room in which fuel-burning appliances are installed.

Installation Procedures

Safety Warning: Hood may have very sharp edges. Please wear protective gloves if it is necessary to remove any parts from installing, cleaning or servicing.

Installation Height

3. The distance between the stove surface and the underside of the range hood must be in the range of 26"-30" Fig(2-A).

The duct opening size is in Fig 2(B)

Vent duct length

4. The length of the vent duct should be minimized to avoid air turbulence inside the duct. (Fig (2-B)).

Balance level:

5. The range hood must be leveled during the installation. An unlevelled installation hood may cause improper operation, leaks and oil spill over from oil collectors. Fig(2-C)

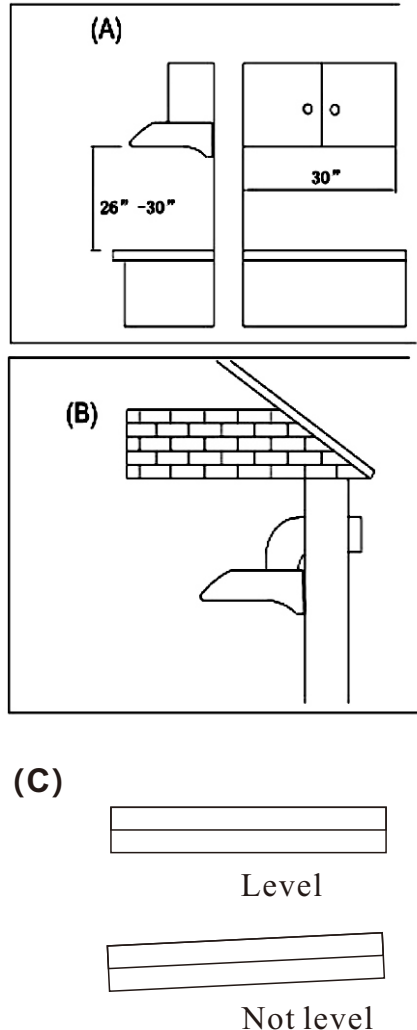
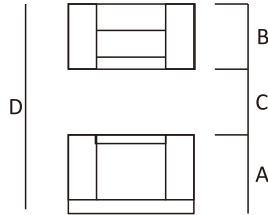

Fig 2

Calculating Vent System Length

To calculate the length of the system you need, add the equivalent feet (meters) for all vent pieces used in the system.

INSTALLATION DIMENSION RECOMMENDATIONS



- A. Countertop Height.
- B. Hood height from ceiling to bottom of the range hood filter surface: $D - A - C = B$.
- C. 24" minimum from cooking surface up to 36" maximum for Electric/Induction range tops. 26" minimum from cooking surface up to 36" maximum for Gas range tops.
- D. Floor to ceiling height.

Exhibit A

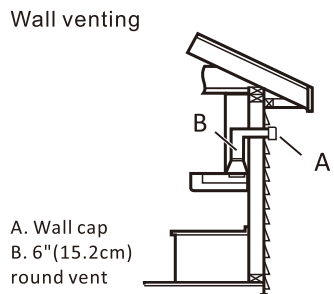
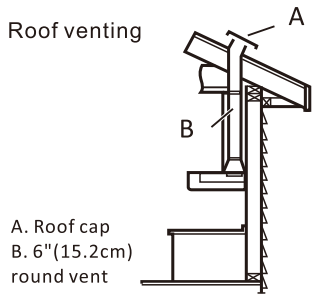

INSTALLATION INSTRUCTIONS for Undercabinet Range Hood

Parts supplied

Note: The fasteners included may not be suitable to your cabinet. Please check with the installer on proper fasteners to be used based on the material makeup of your cabinet

- (A) Range Hood
- (B) Power cord for hard wiring, or Power cord with 3-prong plug, depending on model
- (C) 7" round air vent (attached to top of range hood)
- (D) (D) Optional 3-1/4" X 10" air vent (included in packaging). (6) #8 X 3/8" screw for securing air vent (screws are included in air vent packaging).
- (E) (2-3) Aluminum mesh filters or (2-3) Baffle filters, depending on model (attached to the bottom of the range hood)
- (F) Optional rear power cord exit (punch out)
- (G) (2) Easy installation bracket for frameless cabinet
 - a. (16) #8 X 5/8" wood screw
- (H) (2) Easy installation bracket for framed cabinet
 - a.(8) #8 X 5/8" wood screw
 - b.(8) #8 X 3/8" machine screw
- (I) Charcoal filters for non-ducted use (included in some models)
- (J) (2) Drywall Anchor and (2) 1-3/16 drywall anchor screw. **Optional use for securing range hood to wall if cabinet bottom is not stable enough to support range hood.**

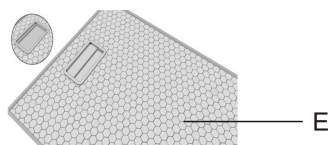
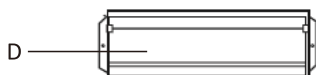
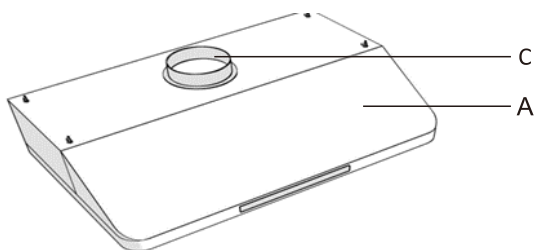
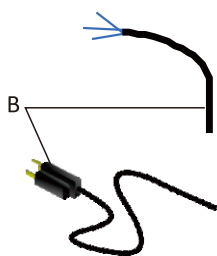

Ventilate out of your dwelling vertically by using the 6" round air vent (c) of located on top of the range hood.

1. Remove the (7) set screws from the air vent (C) that is attached to the top of the range hood and remove the air vent.

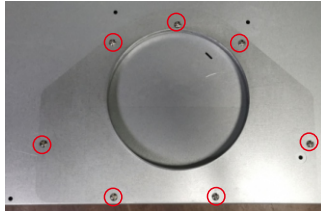

2. Using a flat head screwdriver and pliers, remove the 3-1/4" X 10" stainless-steel plate.

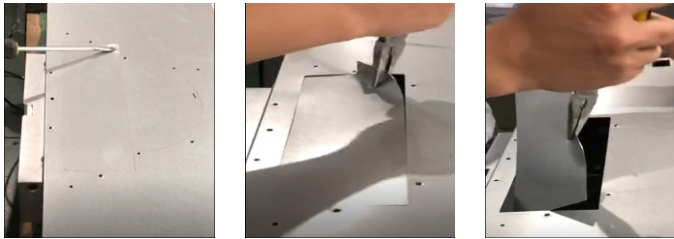

3. Using a flat head screwdriver and pliers, remove the half-round stainless-steel plate.

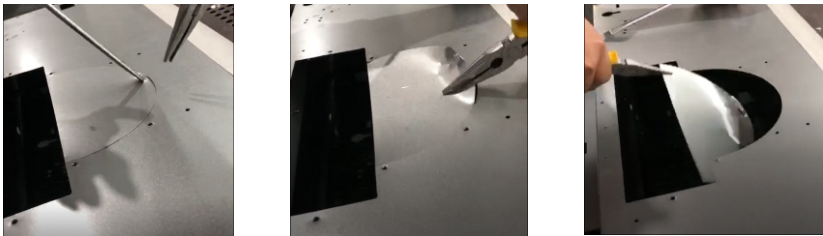

4. Reassemble the air vent (C) to the top of the range hood using the (7) set screws removed in step one.

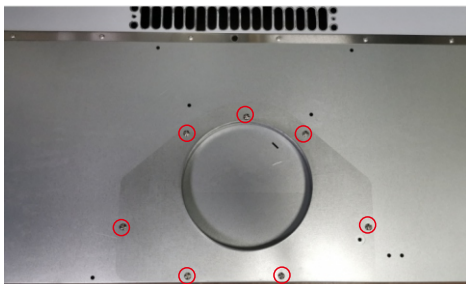

Ventilate out of your dwelling vertically by using the 3-1/4" X 10" air vent (D) that will be assembled on the top of range hood

1. Follow steps 1 and 2 from above. ***Do not remove the half-round stainless-steel plate***

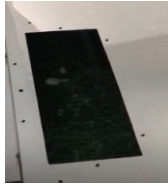

2. Attach the 3-1/4" X 10" air vent (D) using the (6) #8 X 3/8 screws.

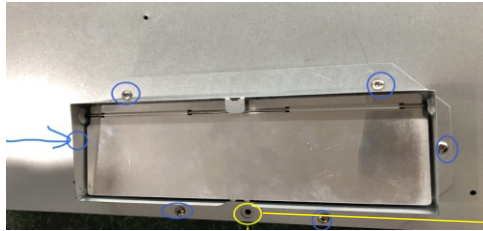

Do not use this hole

Ventilate out of your dwelling horizontally by using the 3-1/4" X 10" air vent (D) that will be assembled to the rear of range hood

1. On the rear of the range hood, remove the two set screws as shown below. Some models may not have set screws.



2. Using a flat head screwdriver and pliers, remove the 3-1/4" X 10" stainless-steel plate.



3. Attach the 3-1/4" X 10" air vent (D) using the (6) #8 X 3/8 screws.



Recirculate the air (non-ducted) within your dwelling

1. Remove the (4) set screws from the air vent (C) that is attached to the top of the range hood.

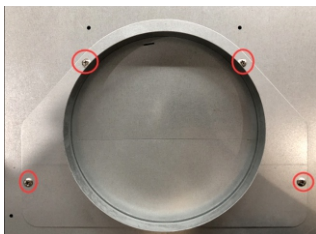

2. Discard the air vent (C) and set screw. Note: You may also discard the 3-1/4" X 10" air vent (D).
3. Remove the recirculating plate cover (located on top of range hood) by removing the two set screws. Discard the recirculating plate cover.

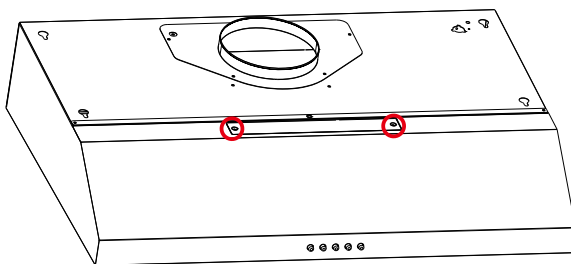

Power cord option for Hard Wired Models

1. The power cord is preconfigured with an exit to the top of the unit.
2. To have the power cord exit the rear of the unit remove the filters (E).
3. Place range hood on work surface with bottom facing up.
4. With a flat head screwdriver, insert the screwdriver into the punch-out slot (F) and pull towards you. This will remove the pre-formed power cord hole cover. Discard the punch-out.

5. Pull the power cord out of the preassembled location and insert into the rear exit hole (F).
6. For some models, you may have to remove the strap holding down the power cord. Simply remove the two nuts and the strap. This will give slack to the power cord to move to the new location. Replace strap and nuts after power cord has been moved to new location. **See Exhibit B.**

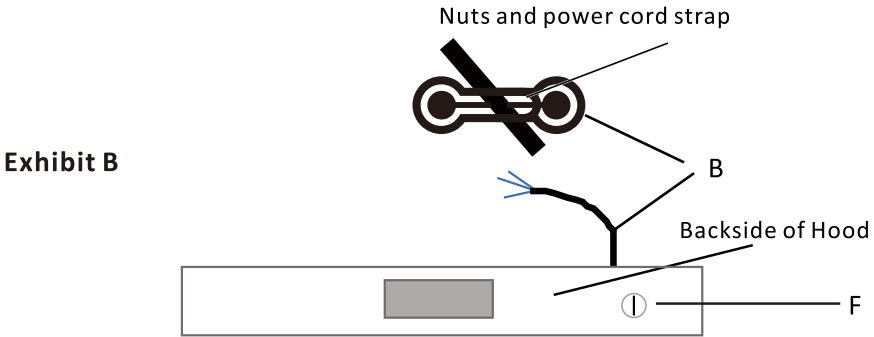

Installing the Range Hood

This installation is for mounting the product to the bottom of the cabinet. Please consult your professional installation specialist regarding the best type of mounting to suit your cabinets construction. Please be sure to read the entire instructions prior to installation.

1. Begin installation by removing the baffle or mesh filters from the bottom of the range hood, removing any tape on the air flow flappers, and removing any protective film on the touch sensor control panel (depending on model).
2. Determine location of power outlet or hardwire connection. You will need to create a cut-out hole on the bottom of the cabinet for the power cord. Prior to mounting the range hood, the power cord will be fed through the cut-out hole. For hard-wired installations choosing the rear exit for power, this cut-out hole is not required (see *Power cord option for Hard Wired Models*).
3. **For Ducted Installations Only:**
 - a. Measure the location where the duct (C or D) will enter the bottom of the cabinet or the wall for rear ducting.
 - b. Drill/cut out the required openings using a sabre saw or jigsaw for the duct; make sure the duct opening is large enough accommodate ducting and to apply duct tape.
 - c. The cutout can be larger than the duct (C or D) dimension to allow room for ducting and duct tape.

Prior to creating cut-outs, please verify the accuracy of your dimensions with a tape measurer and consult with a professional installation specialist.

Ducted/Ductless Operation

1. Some models, depending on motor configuration, have a lever on the bottom of the range hood to determine whether the range hood will operate in the ducted or ductless mode. For other models, simply removing or not removing the recirculating plate cover on top of the range hood will determine ducted or ductless mode of operation. If your model has this lever shown on the image below, you will select either the ducted or ductless mode of operation.
2. On the bottom of the range hood, there will be a lever to determine the airflow. Select **External** if you chose the ducted option. Select **Ductless** if you chose the recirculating option. The mode of operation is preset to external ventilation. For ductless operation, remove the screw as in the picture below, and flip the lever to ductless. Reattach the screw.

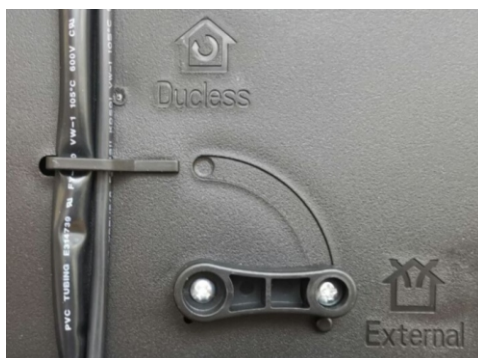





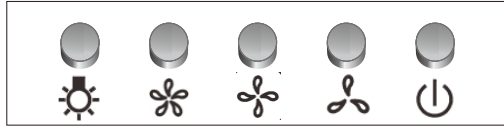

Electrical

1. If your unit comes with a three-pronged plug, insert into outlet.
2. If your unit is hard-wired, make sure this is done by a qualified electrician in accordance with all national and local electrical codes.
 - a) Before connecting the wires, switch the power off at the service panel and lock the service panel to prevent power from being switched on accidentally.
 - b) Connect the Black to Live, White to Neutral, and Green to Ground by either a solder or with electrical connectors.
 - c) This unit must be properly grounded.
3. Install duct work and seal with duct tape.
4. Reinstall the filters (E).

Operation

Push Button



-  Press to turn on /off the light.
-  Press to select the high speed.
-  Press to select the medium speed.
-  Press to select the low speed.
-  Press to select on/off.

Maintenance

Caution: Never put your hand into the area housing while the fan is operating. For the optimal level of operation, clean the range hood surface, fan, and stainless steel filter regularly.

Use only mild soap or detergent solutions to clean the range hood surface. Dry surface using soft cloth.

Using a stainless steel cleaner to bring the shadow back into a stainless steel finish.

Clean the filter once a week or according to use status. Press the buckle of the filter slightly, take off the filter and soak it into warm soapy water.

Clean the motor fan and other inside parts, once every half year or according to usage status by qualified person.

DO NOT clean motor with water or other liquid.

To Replace Light

Caution: LED light can not replace a new bulb, replace the whole LED light. Make sure all the control switches are off, and the range hoods unplugged!

Please follow below instructions:

Take out the filters and cut off the wire connection of the light, press the spring according to the arrow direction, then you can take off the LED light unit.

You can replace a new LED light unit no more than rating!

Then put the light unit to the hood in reverse direction. Connect the wire of the lamp.

Fit on the filters.

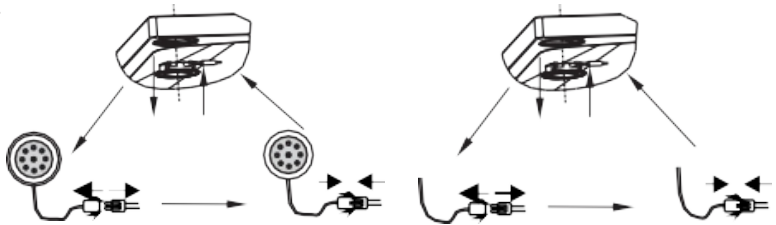

Installation instructions

Preparing the range hood:

1. Open the electrical knockout which is best for your wiring.
2. Fix the shutter to the range hood's vent; prevent the leakage of oil by taping the connection with aluminum metal adhesive tape, or duct tape.
3. Attach the rubber support to the back of the range hood.
4. Unscrew and remove the range hood's bottom cover.

Important safety instructions

1. Pass the wiring through the electrical knockout hole in the range hood.
2. Put the range hood onto the bottom of the cabinet. Make sure the rear side is close to the wall, and the hood is equally spaced on each side and that the top of the range hood is attached to the cabinet. On each side of the range hood, use 2pcs screws to fix the body to the cabinet.
3. Connect the green wire from power source to the green ground wire on the range hood. Make the electrical connection by fastening the white wire line to white and the black wire to black.
4. Reinstall the range hood's bottom cover and stainless steel baffle filters.
5. Reinstall the oil container.
6. Turn on the power and check the operation of the fans and light.

Troubleshooting

Status	Method of fixing
Bulb does not light up	<ol style="list-style-type: none"> 1. Check power to the hood or 2. Replace with a new bulb.
Motor does not work	<ol style="list-style-type: none"> 1. Take off the filter and check the power connection. 2. Check if the air inlet and wind chamber is sealed or not. 3. Check the exhaust pipe and wind chamber has oil leakage. 4. Check if there is damage on the control panel. 5. Lubricate the motor 6. Check if the motor has a bad odor after a moment of operation, possible that the motor burned out. 7. Remove the vane and rotate the vane by hand. If the vane cannot move smoothly, the core or the bearing of the motor might be damaged 8. Replace the capacitor. 9. Replace the motor.
Machine vibrates when switched on	<ol style="list-style-type: none"> 1. Fasten the body. 2. Check for damaged vane. 3. Check if the vanes are installed properly. 4. Fasten the motors.
Machine makes loud noise	<ol style="list-style-type: none"> 1. Regulate bob-weight or replace the vanes. 2. Check to see if something has fallen into the air chamber.
Weak suction	<ol style="list-style-type: none"> 1. Do not open too many windows; this will reduce the suction. 2. Replace the motor and the capacitor.
Oil leakage	<ol style="list-style-type: none"> 1. Ensure the hood is level. 2. Replace the sealant.

READ AND SAVE THESE INSTRUCTIONS

Made in China
Xianggang Huanqiu MaoYiDianQiYouXianGongSi
13/f room 1318-1320 hollywood plaza 610 nathan road
mong kok kowloon
hongkong
999077