

Tieasy

INSTALLATION AND USER'S MANUAL

Customer Service: E-mail: info@Tieasyfactory.com

Contents

1. Close-up View.....	02
2. How to Use Your Gas hob.....	02
3. How to Keep Your Gas hob in Shape.....	03
4. Practical Advice.....	04
5. Is there a problem?.....	05
6. Installation Instructions for built-in.....	06
7. Table1 Burners and Nozzle Specifications	10
8. Table2 How to convert gas source.....	13
9. Table3 Adapting to different types of gas	14
10. NOTICE	14

Congratulations on choosing this appliance, which you will find it is dependable and easy to use. We advise you to read this manual for best performance and to extend the life of your appliance. Thank you.

Close-up View

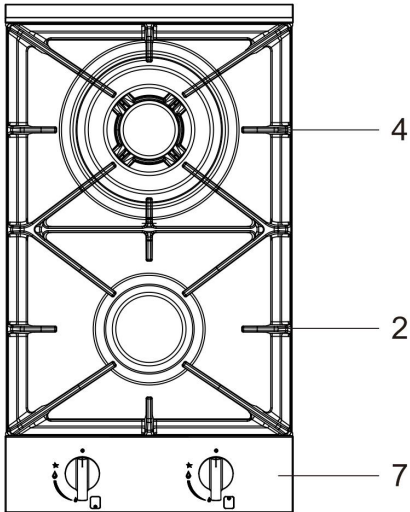

PG3021BG-HC2BI1

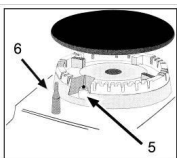

1. Auxiliary Burners
2. Semi-rapid burner
3. Rapid burner
4. Triple ring wok burner
5. Ignitor for Gas Burners (only on certain models)
6. Safety Device (only on certain models) - Activates if the flame accidentally goes out (spills, drafts, etc.), interrupting the delivery of gas to the burner.
7. Control Knobs for Gas Burners and Electric Hot Plates
8. pressure regulator

How to Use Your Gas hob

The position of the corresponding gas burner is indicated on each control knob.

Gas Burners

The burners are different in size and power. Choose the most appropriate one for the diameter of the cookware being used.

The burner can be regulated with the corresponding control knob by using one of the following settings:

- OFF
- ★ High
- Low

On those models fitted with a safety device (F)

The knob must be pressed for about 6 seconds until the flame is lighted and warmed up.

On those models fitted with an ignitor (D)

The "E" ignition button, identified by the ★ symbol, must be pressed first, then the corresponding knob is pushed and turned in the counter-clockwise direction to the "High" setting.

Some models are equipped with an ignition switch incorporated into the control knob. If this is the case, the ignitor (D) is present, but not the switch (the ★ symbol is located near each knob).

To light a burner Simply press the corresponding knob and turn it in the counter-clockwise direction to the High setting, keep press until the burner is lighted.

Caution: If the flame goes out accidentally, turn off the gas with the control knob and try to light it again at least 1 minute later.

To turn off a burner Turn the knob in the clockwise direction until it is stopped (it should be on the "■" setting).

How to Keep Your Gas hob in Shape

Before cleaning or performing maintenance on your gas hob, disconnect it from the electrical power supply (included battery power).

To extend the life of the gas hob, it is absolutely indispensable that it is cleaned carefully, thoroughly and usually, please keep in mind to the following:

- The enameled parts and the glass top, must be washed with warm water without using abrasive powders or corrosive substances which could ruin them;
- The removable parts of the burners should be washed usually with warm water and soap, make sure to remove caked-on substances;
- Automatic ignitor pin, the end must be cleaned carefully and usually, make sure ignition keep working normally.
- Stainless steel top plate and other steel parts can be stained if keep touch with high concentration calcareous water or corrosive detergents (containing phosphorus). To extend the life, we advise these parts be rinsed thoroughly with water and dry them by blowing, It is a good idea to clean up any spills too.
- After glass hob working, the surface must be cleaned by a damp cloth to remove dust or food residues.

Glass surface should be cleaned regularly with warm water and non-corrosive detergent.

First, to remove all food residues or greases with a cleaning scraper, e.g.

While the cooking surface is warm, clean it with a suitable cleaning product and paper towels, then rub with a damp cloth and dry surface. Such as aluminum foil, plastic items, objects made of synthetic material, sugar or foods with a high sugar content that have been melted onto the surface, it must be removed immediately.

While the cooking surface is still hot, clean it with a scraper and a transparent protective film which prevent to make more dirt. This also protect the surface from damage caused by food with a high sugar content.

Do not use abrasive sponges or cleaning products, these holds true for chemically aggressive cleaners, like oven sprays and stain removers (Fig.2);

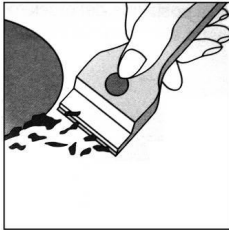

Fig.1

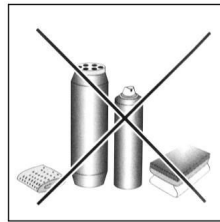

Fig.2

- Cleaning the grill/pan support, it is recommended to clean it while it is still hot. To move grill away from the hob and put it in sink, remove the food residues or grease first, after grill has cooled, rinse it with water.

Greasing the Gas Valves

Over time, the gas valves may be stucked, and it is difficult to turn on/off. For this case, should clean the inside of valve and greased it.

N.B.: This procedure must be performed by a technician authorized by the manufacturer.

Practical Advice

Practical Advise on Using the Burners

For best performance, follow these general guidelines:

- Use the appropriate cookware for each burner (see table) in order to prevent the flame to reach the side of the pot or pan;
- Always use cookware with a flat bottom and keep the lid on;
- When the contents come to a boil, turn the knob to "Low".

Burner	Ø Cookware diameter (cm)
Auxiliary burner	10~14
Semi-rapid burner	16~20
Rapid burner	22~24
Triple ring wok burner	24~26

To identify the type of burner, refer to the designs in the section entitled, "Burner and Nozzle Specifications".

Practical Advice on Using the Half Fish-Kettle Burner

The two central burners, or Half Fish-Kettle burners, are elliptic in form and can be turned up to 90°. This makes the cooktop more flexible in terms of how it can be used.

To turn the two central burners 90°, proceed as follows:

- Make sure that the burners are cool;
- Lift the burner completely out of its housing;
- Replace it in its housing in the position desired;
- Make sure that the burners are positioned correctly before use.

In addition, the two central burners can be used in tandem or separately with cookware of different

For best performance, keep in mind the following:

- All types of casseroles can be used on the ceramic glass cooking surface. However, it is important that the bottom be perfectly flat. Casseroles with thicker bottom distribute heat more evenly.



The cookware bottom diameter at least as large as the cooking area so that all of the heat produced by the heating element is used.



- Make sure that the bottom of the pot is always dry and clean to insure good contact between the cookware and the cooking surface. This also extend the life of pots and ceramic glass surface as well.
- Do not use the same cookware which for gas burners because the concentrated heat they produce can deform the bottom of the pot. Therefore, you will not achieve best results when using these pots on the ceramic glass surface.

Is there a Problem?

If you find gas hob cannot work suddenly or cannot work properly. Before calling customer service for assistance, let us check what we can do.

First of all, check and confirm there have no interruptions to the gas and electrical supplies.

Particularly if the gas valves keeping turn on.

The burner cannot be lighted or the flame is not uniform around the burner.

Check to make sure that:

- The gas holes on the burner are not clogged;
- All of the movable parts that make up the burner are fixed correctly;
- There are no air flow around the cooking surface.

The flame do not keep lighting to the burner with thermocouple.

Check to make sure that:

- You press the knob all the way;
- You keep pressing the knob for an enough time to activate the thermocouple.
- The gas holes are not clogged in the area corresponding to the thermocouple.

The flame go out while turn knob to "Low" setting.

Check to make sure that:

- The gas holes are not clogged.
- There are no air flow around the cooking surface.
- The minimum has been adjusted correctly (see the section entitled "Minimum Regulation").

The cookware is not stable.

Check to make sure that:

- The bottom of the cookware is perfectly flat.
- The cookware is centered correctly on the burner..
- The support grids have not been inverted.

After checked all of these, the gas hob still do not work properly, please call the Customer Service Center and inform them of:

--Tile type of problem.

--The gas hob model number (Model....) as indicated on the packing carton.

Never call the technicians who is not authorized by your supplier, and refuse to use the spare parts which are not from manufacturer.

Installation Instructions for built-in

The following instructions are directed at the qualified installer, so the installation and maintenance procedures may be followed in the most professional and expert manner.

Important: Unplug the electrical connection before performing any maintenance or regular upkeep work.

Positioning for gas hob

Important: this unit may be installed and used only in permanently ventilated rooms according to the British Standard Codes of Practice: B.S. 6172 / B.S. 5440, Par. 2 and B.S. 6891 Current Editions.

The following requirements must be observed:

- a) The room must be fitted with a ventilation system which ventilate smoke and gases from combustion to the outside of rooms.

This must be done by hood or electric ventilator.



In a chimney stack or branched flue.
(exclusively for cooking appliances)

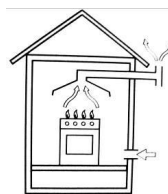

Directly to the Outside

- b) The room must be allowed for the influx of the air which for proper combustion. The air flow for combustion purposes must not less than 2 m³/h per kW of installed capacity. The air supply will be effected by influx from the outside through a duct, its inner cross section is at least 100cm² and must not

be blocked accidentally.

The gas hob without safety devices, to prevent flame go out accidentally, must have a ventilation working on twice volume. For example, a minimum of 200 cm² (Fig. 3). Otherwise, the room can be vented indirectly through adjacent rooms which is fitted with ventilation ducts to the outside. Although the adjacent rooms are not shared areas, bedrooms, but fire risk is hidden (Fig. 4).

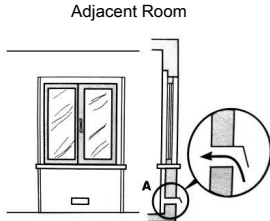

Examples of ventilation holes for comburent air.

Fig.3

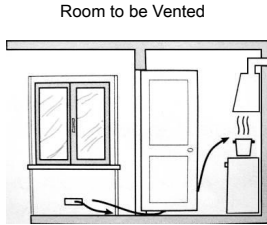

Enlarging the ventilation slot between window and floor

Fig.4

- c) Intensive and prolonged working of the gas hob that need to intensify ventilation, e.g. opening windows or increasing the power of the air intake system (if present).
- d) Liquefied petroleum gases are heavier than air, so settle it downward. Rooms in which LPG tanks are installed must be fitted with ventilation to the outside to avoid of gas leakage.

Therefore, LPG tanks which are empty or partially full, must not be installed or stored in rooms or spaces below ground level (cellars etc.). It is a good idea to keep only the tank which is working currently in the room, and make sure that it is not closed to heating source (ovens, fireplaces, stoves, etc.).

Installation of built-in gas hob

The gas hobs are designed with protection degree against excessive heating, the appliance can be installed next to cabinets, and the height should not exceed the hob.

For a correct installation, the following precautions must be followed:

- a) The hob may be located in a kitchen, a diner or bed/ sitting room, but not in a bathroom or shower room.
- b) The furniture standing near to the unit, it is higher than the working boards, must be placed at least 110mm distance to the edge of the board.
- c) The cabinets should be positioned near to the hood at a height of 420 mm at least (Fig. 5).

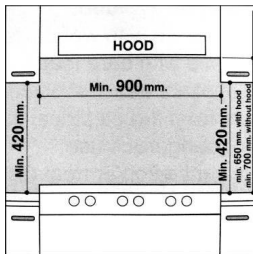

Fig.5

- d) Hob should be installed directly under a cupboard, the latter should be at least 700mm from the worktop, as shown in Fig. C.
- e) Fixing fittings (hooks, screws) are provided to place the hob on work top, measure 20 to 40 mm in

thickness (see Fig. 6).

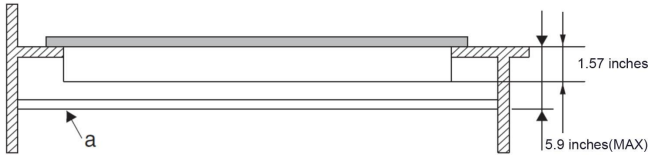
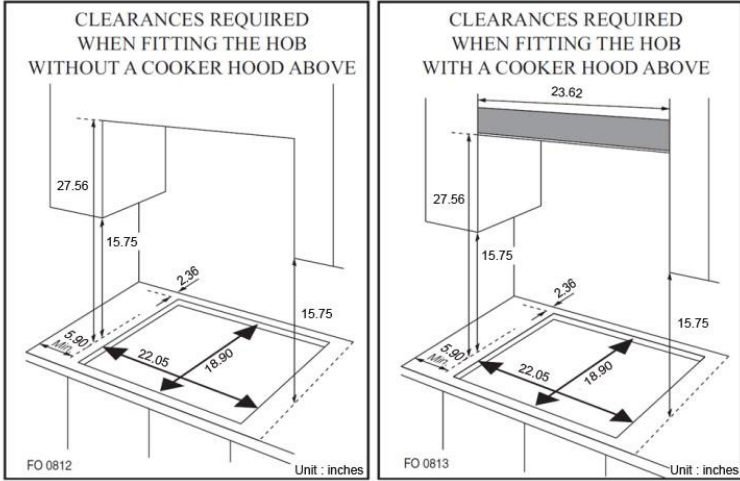
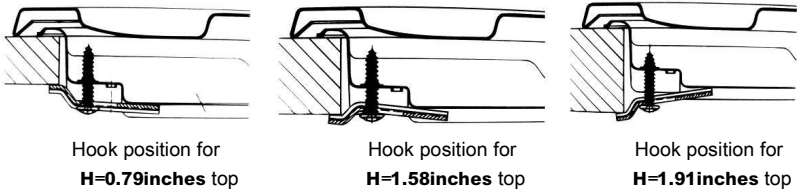

Fig.6



N.B: Use the hooks contained in the "accessories bag"

f) In the event the gas hob is not installed on a built-in oven, a wooden panel must be inserted for insulation. This panel must be placed at least 20 mm distance from the bottom of hob.

Important: When installing the hob on a built-in oven, the oven should be placed on two wooden strips; in the case of a joining cabinet surface, remember to leave a space of 45 x 560 mm at least from the back

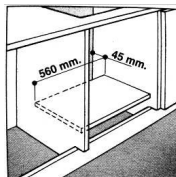
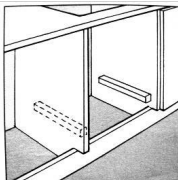

side..

When install hob on a built-in oven without forced ventilation, ensure that have air inlets and outlets to ventilate the interior of the cabinet adequately.



Gas connection for gas hob

The gas hob should be connected to the gas-supply by a registered installer. During installation it is essential to fit an approved gas tap to isolate the supply from the hob for the convenience of any subsequent removal or servicing. Connect the hob to the gas mains or liquid gas, it must be carried out according to the prescribed regulation in force, and only after it is ascertained that it is adaptable to the type of gas to be used. If not, follow the instructions indicated in the paragraph headed "Adaptation to different gas types". In the case of connection to liquid gas by tank, use pressure regulators that conform to the regulation in force.

Important: For safety, for the correct regulation of gas use and long life of the hob, ensure that the gas pressure conforms to the indications given in table 1 "Burners and Nozzle Specifications".

Connection to non-flexible tube

(copper or steel)

Connection to the gas source must be done in such a way as to not create any stress points at any part of the gas hob.

The hob is fitted with an adjustable "L" shape connector and a gasket to the gas supply.

The connector should be dismantled and the gasket must be replaced.

The feeding connector of the gas to the hob is threaded 1/2 gas cylinder.

Connection to flexible steel tube

The gas feed connector to the hob is threaded, 1/2" connector for round gas pipe. Only use pipes and sealing gaskets that conform to the standards currently in force. The maximum length of the flexible pipes must not exceed 2000 mm. Once the connection has been made, ensure that the flexible metal tube does not touch any moving parts and not be crushed.

Check the Seal

Once the hob was installed, make sure all the connections are properly sealed, use a soapy water to test, never use flame.

Electrical Connection

The hob fitted with a tripolar electrical supply cord which are designed to be used alternating current .According to the indications on the rating plate located under the hob. The earthing wire can be identified by its yellow-green colour.

In the case of installation over a built-in electric oven, the electrical connections for the hob and oven should be independent, not only for safe purpose, but also be convenient to remove them in the future.

Electrical Connection for Gas hob

Fit the supply cord with a standard plug for the demand rate indicated on the rating plate or connect it directly to the electrical mains. In the latter case, a single pole switch must be placed between the hob and the mains, with a minimum opening between the contacts of 3 mm in compliance with current safety codes (the earthing wire must not be interrupted by the switch). The power supply cord must be positioned so that it does not reach a temperature in excess of 50°C than room temperature at any point.

Before actual connection make sure that:

- The fuse and electrical system can withstand the load required by the hob;
- The electrical supply system is equipped with an efficient earth hook-up according to the norms and regulations prescribed by law;
- The plug or switch are easily accessible.

Important: the wires in the main lead are coloured in accordance with the following code:

Green - **Earth**
 Black - **Neutral**
 white - **Live**

As the colours of the wires in the main lead may not correspond with the coloured markings identifying the terminals in your plug, proceed as follows: Connect the Green & Yellow wire to terminal marked "E" or  or coloured Green or Green & Yellow.

Connect the Brown wire to the terminal marked "L" or coloured Red.

Connect the Blue wire to the terminal marked "N" or coloured Black.

Table1: Burners and Nozzle Specifications

Adapting the Gas hob for Different Types of Gas

Burner	NG		LPG	
	Nomral Burner Capacities (kW)	Nozzle 1/100 (mm)	Nomral Burner Capacities (kW)	Nozzle 1/100 (mm)
Auxiliary (Small) (A)	1.0	75	1.0	53
Semi rapid (Medium)	1.8	100	1.8	68
Rapid (R)	2.4	115	2.4	79
Triple Ring (TR)	3.4	130	3.4	93
Supply pressures	5" W.C.		10" W.C.	

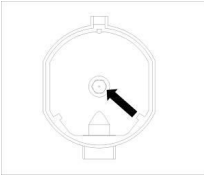

Replacement of burner nozzle: loosen the nozzle with a dedicated wrench(7).Fit the new nozzle according to the required gas type (see table 1 for reference).

After you have converted the gas hob to another gas type, make sure you have placed a label containing that information on the appliance.

ADAPTING THE COOKTOP FOR DIFFERENT TYPES OF GAS

To adapt the cooktop to a different type of gas than that for which it was designed, (see the sticker under the hob or on the package), the burner nozzles must be changed, as follows:

- Remove the pan supports and slide the burners out of the cooktop.
- Unscrew the nozzles using a 7mm socket wrench and replace them with those for the new type of gas.
- Reassemble the parts following the instructions in reverse order.
- On completing the operation, replace the old rating label with the one showing the new type of gas; the sticker is available from our SERVICE CENTRES.

To complete the conversion, follow up below,

- Replacement of the burner injectors
- Regulation of the burner flame level
- Leak test

Replacement of the burner injectors

Inside the box there is one pair of gas burner jets for opposite gas type, sealed in a small bag.

Fig. 8

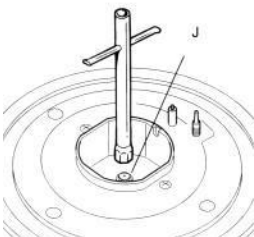

Remove the pan support and the burner covers;

Using a wrench (Not included in the product), substitute the nozzle injectors; "J" (Fig.8) with the pair provided in the small bag.

Regulation of the burner flame level

Regulation of the burner flame level; when switching from one type of gas to another, the minimum flow rate must be adjusted so the flame should not go out. To regulate the flame follow;

- Light up the burner
- Turn the knob to minimum level
- The adjustment screw is located next to the valve (fig.9). Please remove/pull out the control knob to access it.
- Using a screwdriver (Not included in the product) with max. Diameter 3 mm, turn the screw inside the tap until the correct setting is obtained.

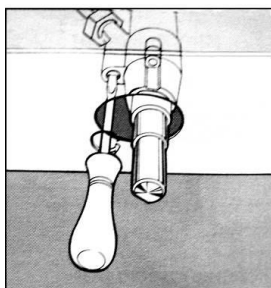

(Fig. 9)

Leakage Test

- It is recommended that the gas hob shall be installed and tested by professionals.
- If no professionals and the user doesn't have testing equipment, soapy water is recommended to detect leakage.
- Connect the hob to the gas, but NOT electricity.
- Mix water and detergent together, and apply the soapy water to the adjustment screw, which is the position adjusted with screwdriver.
- If there is a gas leak, there will be a lot of bubbles.

WARNING: FIRE HAZARD: DO NOT use a flame to check for gas leaks.

TABLE2: How to Convert Gas Source

Adjustment of the reduced valve flow

Burners	Flame	Converting the hob from LPG to natural gas	Converting the hob from natural gas to LPG
Regular burners	Full flame	Replace the burner Nozzle according To the guidelines in table 1	Replace the burner Nozzle according to the guidelines in table 1
	Saving flame	Loosen the adjustment Spindle (<i>see fig.7 below</i>) And adjust the flame	Loosen the adjustment Spindle (<i>see fig.7 below</i>) And adjust the flame

Valve adjustment

Valve adjustment should be done with the control knob set at Burner ON saving flame position. Remove the knob, and adjust the flame with a tiny screwdriver (see fig.7 below).

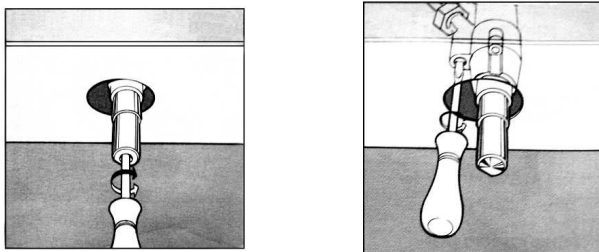

Fig.7

To check the adjusted flame: heat the burner at full open position for 10 minutes. Then turn the knob into the saving setting. The flame should not extinguish nor move to the nozzle. If it extinguish or moves to the nozzle, readjust the valves.

Flame selection

As the burners are adjusted correctly, the flame should be light blue, and the inner flame should be clear. The size of flame depends on the position of the related control knob.

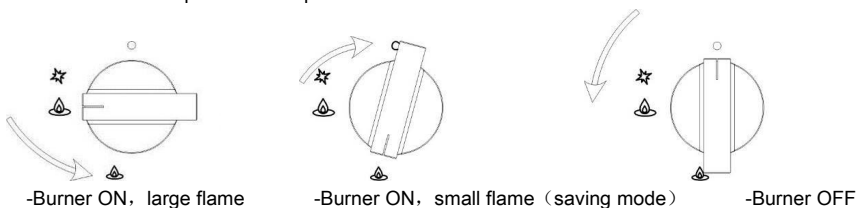

Fig.8

See fig.8 for various operating options (flame size selection); the burner should be set at a large flame during the initial phase of cooking, it make food boil quickly. Then should turn knob to the saving flame position to maintain the cooking. It is possible to adjust the flame size stepless.

It is prohibited to adjust the flame between the Burner OFF and Burner ON large flame positions.

High quantity of energy can be conserved if the hob is used correctly, parameters are designed correctly, and appropriate cookware is used. The energy conservation be as follows:

- Up to 60% are conserved when proper pots are used,
- Up to 60% are conserved when the unit is operated correctly and the suitable flame size is chosen..

It is a prerequisite for efficient and energy-saving operation of hob that the burners are kept clean at all times (in particular the flame slots and nozzles). **Adapting to different types of gas**

Pressure regulator (Not included in the product) adjustment

Please do remember that pressure regulator adjustment should be done by a qualified technician.

Remove the cap of gas regulator, adjust the spring (as fig.9) to convert the gas to be L.P.G; and convert gas type to be N.G by inverting the spring and install it(as fig.10).

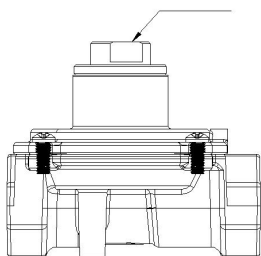

Fig.9 LPG



Fig.10 NG

TABLE 3: Adapting to different types of gas

Burner	NG	Pressure	Nozzle diameter	Nominal Charge			
		W.C.	1/100mm	g/h	l/h	kW	kcal/h
Auxiliary	NG	5	75	—	76	1.0	702
	LPG	10	53	66.5	—	1.0	702
Semi-rapid	NG	5	100	—	134	1.8	1268
	LPG	10	68	119	—	1.8	1268
Rapid	NG	5	115	—	183	2.4	1694
	LPG	10	79	156	—	2.4	1694
Triple-ring wok	NG	5	130	—	260	3.4	2374
	LPG	10	93	224	—	3.4	2374

NOTICE:

- A. Prior to installation, ensure that the local distribution condition (nature of the gas pressure) and the adjustment of the appliance are compatible.”

- B. "The adjustment conditions for this appliance are stated on the rating label."
- C. "This gas hob is not connected to combustion products evacuation device. It shall be installed and connected in accordance with current installation regulations. Particular attention shall be given to the relevant requirement regarding ventilation."
- D. "CAUTION: The use of a gas hob lead to the production of heat, moisture and products of combustion in the room in which it is installed. Ensure that the kitchen is well ventilated especially when the hob is in working: keep natural ventilation holes open or install a mechanical ventilation device."

Tieasy

Foshan Fanmi Home Technology Co., Ltd.

Add: 11F-6, West of Building E, No. 6, Keyuan 3rd Rd.,
Xiaohuangpu Community, Ronggui St., Shunde Dist.,
Foshan, Guangdong

Manufacturer:

Zhongshan HEME Kitchen Appliance Co., Ltd.

Add: Dongfu Road, Dongfeng, Zhongshan, Guangdong, China