

标记	更改内容	区域	更改文件编号	日期	登记	审核
△						

普通尺寸公差	公差等级	>0.5~6	>6~30	>30~120	>120~315	>315~1000	>1000~2000
	A级	±0.05	±0.1	±0.15	±0.2	±0.3	±0.5
	B级	±0.1	±0.2	±0.3	±0.5	±0.8	±1.2
	C级	±0.2	±0.5	±0.8	±1.2	±2.0	±3.0
	D级	±0.5	±1.0	±1.0	±1.5	±3.0	±4.0

143 mm

143 mm

全部 6.3

TopStrong

INSTALLATION AND USER'S MANUAL

210 mm

Hinweis auf Deutsche:
Notice en français:



TopStrong
Guangdong ShunDe JieTuo ShengHuoJiaDian Co., Ltd
Add: NO.1,Chaoguinan Rd, Ronggui Shunde District,
Gaojun Tech Innovation Center 3-1105 Foshan Guangdong 528305

Customer Service: E-mail: Tcustomerservice@hotmail.com

此处有变

- 技术要求：
- 1.字体要求印刷清晰，不能出现错印，漏印现象。
 - 2.尺寸按规格要求。
 - 3.印刷版面参照电子档。

项目	批准	校核	设计	重要零件	材质	80克双胶纸	订单编号	PI-0022-23-01					
签字				服务零件	规格	143*210	料号	B53-TV13-2162-03-XX					
日期				安规零件	表面处理		图号	B					
中山市甜美电器有限公司 ZhongShan Tianmei Electrical Appliances Co.,Ltd				比例			数量	重量	零件名称	2162说明书	1/1		
				第一角法	单位	mm						图幅	

CONTENT

INTRODUCTION	2-3
SAFETY PRECAUTION	2-3
INSTALLATION INSTRUCTIONS	4
AIR OUTLET INSTALLATION METHOD	5
WALL MOUNTING INSTALLATION.....	5-7
OPERATION	7
MAINTENANCE	8-9
TROUBLESHOOTING	10
ENVIRONMENTAL PROTECTION	10

INTRODUCTION

INTRODUCTION

Thank you for choosing this cooker hood.

- This instruction manual is designed to provide you with all required instructions related to the installation, use and maintenance of the appliance.
- In order to operate the unit correctly and safely, please read this instruction manual carefully before installation and usage.

SAFETY PRECAUTION

- Never let the children operate the machine.
- The cooker hood is for home use only, not suitable for barbecue, roast shop and other commercial purpose.
- Clean the cooker hood after the specified time (suggestion: every 2 months) according to the instruction manual and keep the unit from danger of burning. There is a fire risk if cleaning is not carried out in accordance with the instructions.
- Please keep the kitchen room with good ventilation before connecting this appliance; Please check that the power supply cord is undamaged. A damaged supply cord must be replaced by qualified service personnel only.
- Regulations concerning the discharge of air have to be fulfilled.
- This appliance can be used by children aged from 8 years and above and also the persons with reduced physical, sensory or mental capabilities or lack of experience and knowledge if they have been given supervision or instruction concerning use of the appliance in a safe way and understand the hazards involved. Children shall not play with the appliance. Cleaning and user maintenance shall not be made by children without supervision.
- If the supply cord is damaged, it must be replaced by the manufacturer, its service agent or similarly qualified persons in order to avoid a hazard.
- There shall be adequate ventilation of the room when the range hood is used at the same time as appliances burning gas or other fuels; the range hood is only intended to be installed over a hob with no more than four hob elements; The air must not be discharged into a flue that is used for exhausting fumes from appliances burning gas or other fuels;

Range hoods and other cooking fume extractors may adversely affect the safe operation of appliances burning gas or other fuels (including those in other rooms) due to back flow of combustion gases. These gases can potentially result in carbon monoxide poisoning. After installation of a range hood or other cooking fume extractor, the operation of flued gas appliances should be tested by a competent person to ensure that back flow of combustion gases does not occur.

! CAUTION:

Accessible parts may become hot when used with cooking appliance.

Electrical Shock Hazard



Only plug this unit into a properly earthed outlet.

If you have doubts, seek advice from a suitably qualified engineer.

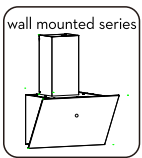

- Lamp type: L09 / L11;
- Shape description: round / rectangle;
- Rated wattage of the intended lamp: 1.5W;
- Max wattage of a potential replacement lamp: 1.5W;
- Rated voltage or voltage range of lamp or for pre-heat starting fluorescent lamp starter replacement detail: 110-240V;
- Nominal dimension of lamp: 68mm / 34.5 * 120mm.

Hardware Included



- | | | |
|---|---|---|
|  × 9 |  × 9 |  × 2 |
| St4 × 30 | φ 8 × φ 35 | St3 × 10 |

Tools Required

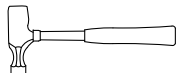
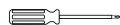
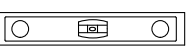
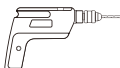
- | | | | |
|--|--------|---|---------------------------------------|
|  | Pencil |  | Measuring tape |
|  | Hammer |  | Screwdriver |
|  | Level |  | Electric drill or powered screwdriver |

INSTALLATION INSTRUCTIONS

Prepare for installation:

Warning: Failure to install the screws or fixing device in accordance with these instructions may result in electrical hazards.

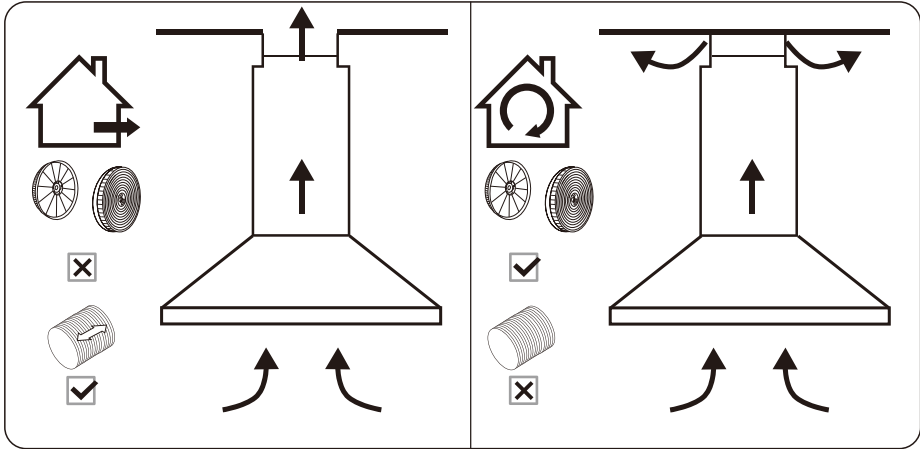

DUCTED OPTION

RECIRCULATION OPTION

a. If you have an outlet to the outside, your cooker hood can be connected as above picture by means of a pipe (with an interior diameter of 150mm). If you don't have an outlet to the outside, you can go with recirculation mode by using carbon filter.

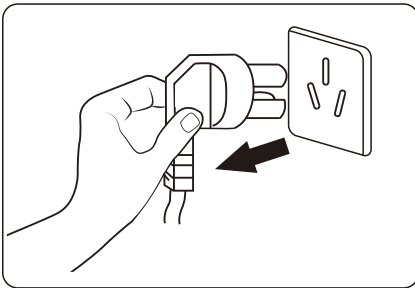

b. Before installation, turn the unit off and unplug it from the outlet.

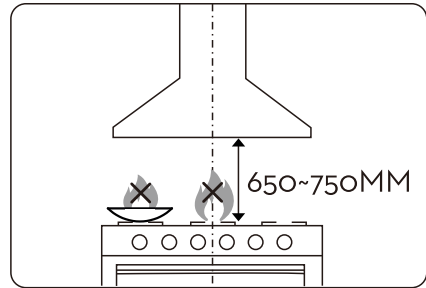

c. The cooker hood should be placed at a distance of 650~750 mm above the cooktop for the best effect.



Do not flame under the range hood

AIR OUTLET INSTALLATION METHOD

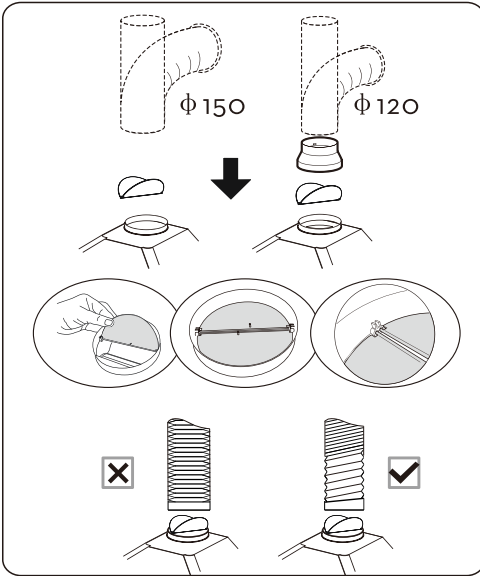

Installation method for 150mm diameter pipe: insert the one-way-valve as the pic and fix the pipe.

Attention: The bump of the one-way-value must be upward.

Installation method for 120mm diameter pipe: insert the damper as the picture and fix the converter before placing the duct.

The pipe near the air outlet need to be fully extended.

WALL MOUNTING INSTALLATION

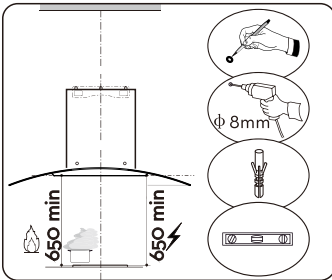

Prepare pencil, electric drill, plastic wall anchors and level before installation.
Recommended installation height: 700mm.
Required minimum installation height: 650mm.

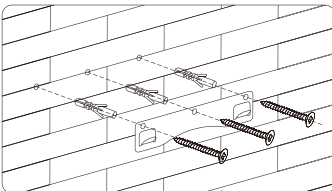

Drill $3 \times 8\text{mm}$ holes to accommodate the bracket. Screw and tighten the hook onto the wall with the screws & plastic wall anchors provided.

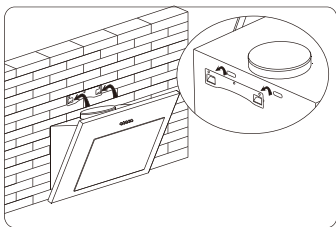

Lift the cooker hood and hang onto the wall hook.

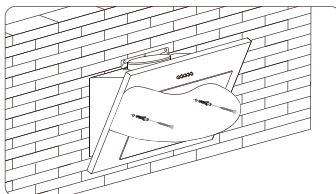

Need to drill $2 \times 8\text{mm}$ extra holes & fixing screws & plastic wall anchors before installation.

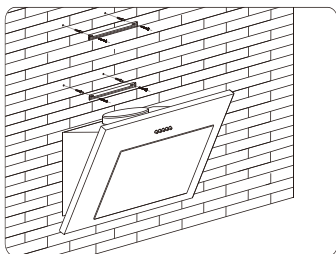

Mark down the position and drill 2 holes for each chimney bracket and tighten the bracket with screws.

i The longer bracket is upper chimney bracket.
Note

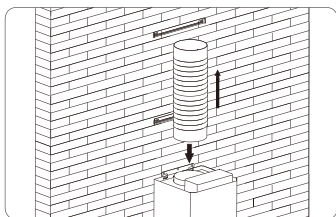

Fix the one-way-valve to the air outlet of the cooker hood, and then attach the pipe onto the air outlet as picture.

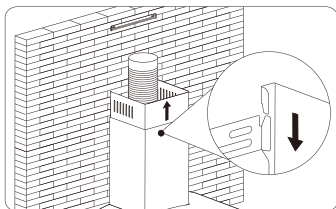

Put the upper chimney into lower chimney . Then pulling out the upper chimney upwards. Adjust to reach the height required.

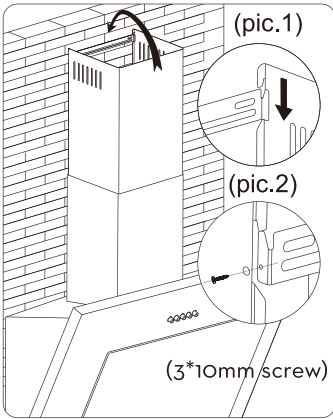

There are 2 methods for installing the chimney cover. Please check the attached pic for reference.

1. After drilling the 2 holes and fixing the bracket, hang the chimney cover by matching the both side locks. (Pic1)
2. After drilling the 2 holes and fixing the bracket, install the chimney cover by locking with 2 screws in both side holes. (Pic2)

OPERATION



 **ON/OFF key**

 **Power down key**

On working condition, press this key to decrease the power one level, (the ON/OFF key light would blink slower than the power was not decreased).

 **Power up key**

On working condition, press this key to increase the power one level, (the ON/OFF key light would blink faster than the power was not increased).

 **Delay key**

When motor is on working condition, press one time to set 5 minutes delay, press another time to turn the delay function off.

 **Light key**

MAINTENANCE

Before cleaning switch the unit off and pull out the plug.

I. Regular Cleaning

Use a soft cloth moistened with hand-warm mildly soapy water or household cleaning detergent. Never use metal pads, chemical, abrasive material or stiff brush to clean the unit.

II. Bulb Replacement

1. Switch the unit off and unplug the appliance.
2. Remove the lamp cover by unscrewing the 2 screws.
3. Unscrew the incandescent bulb.
4. Replace with the same type and rated bulb/lamp
E14 Incandescent Bulb: (E14 Max 40W).

- Lamp type: LO9 / L11;
- Shape description: round / rectangle;
- Rated wattage of the intended lamp: 1.5W;
- Max wattage of a potential replacement lamp: 1.5W;
- Rated voltage or voltage range of lamp or for pre-heat starting fluorescent lamp starter replacement detail: 110-240V;
- Nominal dimension of lamp: 68mm / 34.5 * 120mm.

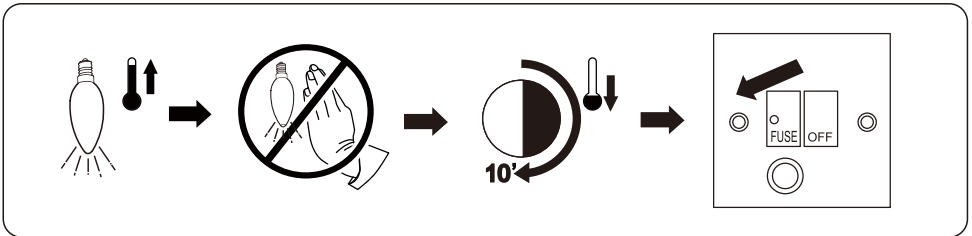

The hot bulb may hurt hands. Please switch off the power for 10 minutes before replace the bulb.

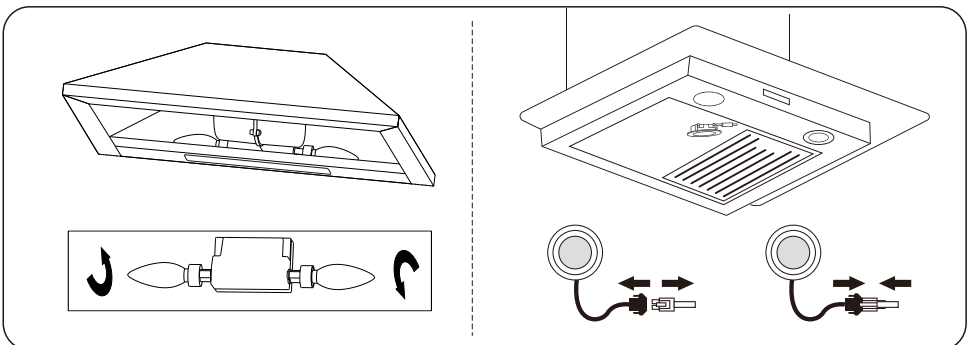

III. Aluminium and carbon filter replacement

In order to install the carbon filter, the grease filter should be detached first. Press the lock and pull it downward.(Carbon filter is NOT included, need to order it separately.)

1 MONTHS

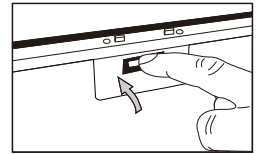
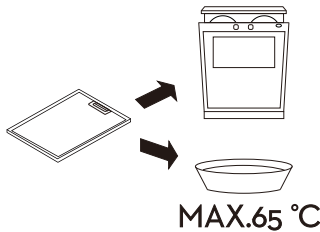
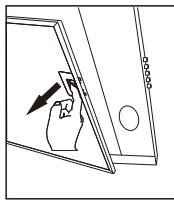

Aluminium filters: To avoid fires, clean thoroughly once a month or whenever the display pilot lights up (if fitted). To do so,remove the filters and soak in hot water and detergent for an hour.If using a dishwasher,position the filters vertically to improve the cleaning process.

VI. Carbon filter life time: Suggest changing to new one every 3 months (According to different kitchen condition, the life time of carbon filter might be longer or shorter than 3 months).(Carbon filter is NOT included, need to order it separately.)

Installation: Fix carbon filter into the unit and turn it in clockwise direction. Repeat the same on the other side.(Carbon filter is NOT included, need to order it separately.)

3 MONTHS

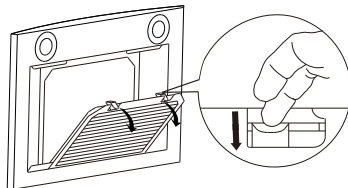
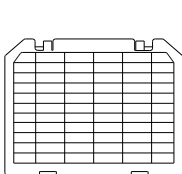
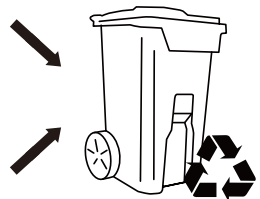
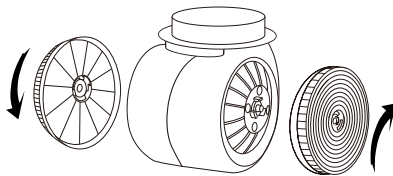
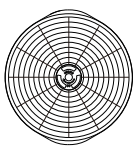

Important Notice:

- 1.Make sure the filter is securely locked. Otherwise, it would loosen and cause abnormal noise and danger.
- 2.Using carbon filter would reduce the air flow of the range hood.

TROUBLE-SHOOTING

Problem	Posible cause	Solution
Light on, but fan does not work	The fan blade is jammed.	Switch off the unit and repair by qualified service personnel only.
	The motor is damaged.	
Both light and fan do not work	Light bulb burn.	Replace the LED light with correct rating.
	Power cord is loose.	Plug into the power supply again.
Serious Vibration of the unit	The fan blade is damaged.	Switch off the unit and repair by qualified service personnel only.
	The fan motor is not fixed tightly.	
	The unit is not hung properly on the bracket.	Take down the unit and check whether the bracket is in proper location.
Suction performance not good	Too far distance between the unit and the cooktop.	Readjust the distance between 650-750mm.

ENVIRONMENTAL PROTECTION

Waste electrical products should not be disposed of with household waste. Please recycle where facilities exist.

Check with your Local Authority or retailer for recycling advice.

