

INSTALLATION INSTRUCTIONS AND OWNER'S MANUAL

INSTALLER:

Leave this manual with the appliance.

CONSUMER:

Retain this manual for future reference.

⚠ WARNING

FIRE OR EXPLOSION HAZARD

Failure to follow safety warnings exactly could result in serious injury, death or property damage.

- Do not store or use gasoline or other flammable vapors and liquids in the vicinity of this or any other appliance.
- **WHAT TO DO IF YOU SMELL GAS**
 - Do not try to light any appliance.
 - Do not touch any electrical switch; do not use any phone in your building.
 - Leave the building immediately.
 - Immediately call your gas supplier from a neighbor's phone. Follow the gas supplier's instructions.
 - If you cannot reach your gas supplier, call the fire department.
- Installation and service must be performed by a qualified installer, service agency or the gas supplier.

LOG SET MODEL

LS35TINF

For Use With DVCT35CBN-1

Fireplace Inserts

GAS-FIRED



NOTICE: Ceramic logs may differ in appearance from those shown in this manual.

⚠ WARNING

If not installed, operated and maintained in accordance with the manufacturer's instructions, this product could expose you to substances in fuel or from fuel combustion which can cause death or serious illness.















NATIONAL
FIREPLACE
INSTITUTE

















CERTIFIED
www.nficertified.org

We suggest that our gas hearth products be installed and serviced by professionals who are certified in the U.S. by the National Fireplace Institute® (NFI) as NFI Gas Specialists.

LOG IDENTIFICATION

PART NO.	DESCRIPTION	DVCT35 LOG SET	
		FRONT	TOP
38450	EMBER BED (A)		
38451	REAR LOG (B)		
38452	LOWER RIGHT LOG (C)		
38453	RIGHT LOG (D)		
38454	UPPER RIGHT LOG (E)		
38455	LOWER LEFT LOG (F)		
38456	LEFT LOG (G)		

LOG IDENTIFICATION

PART NO.	DESCRIPTION	DVCT35 LOG SET	
		FRONT	TOP
38457	UPPER LEFT LOG (H)		
38458	LEFT CROSSOVER LOG (I)		
38459	CENTER LOG (J)		
38460	CENTER CROSSOVER LOG (K)		
38461	LEFT FRONT LOG (L)		
38462	RIGHT FRONT LOG (M)		
15496	GLOWING EMBERS PACKET		
36747	COALS (APPROX.100)		

LOG AND EMBER PLACEMENT

NOTICE: Install liners before logs. See separate Liner Installation instructions for details.

CAUTION

Do not handle these logs with your bare hands. Always wear gloves to prevent skin irritation from ceramic fibers. After handling the logs, wash your hands gently with soap and water to remove any trace of fibers.

Accessing the Interior of the Fireplace

See Installation Manual for instruction on how to remove the barrier screen and glass door.

Log Set Installation

Proper positioning of the logs is critical to the safe and clean operation of this fireplace. Improper log placement may cause sooting and other problems in the fireplace. Please refer to **Figure 1** and the following warning to complete log placement. For pin numbering see **Figure 2**. For step-by-step log placement instructions, see pages 5 - 18.

WARNING

Failure to position the parts in accordance with this diagram or failure to use only parts approved for this fireplace may result in property damage or personal injury.

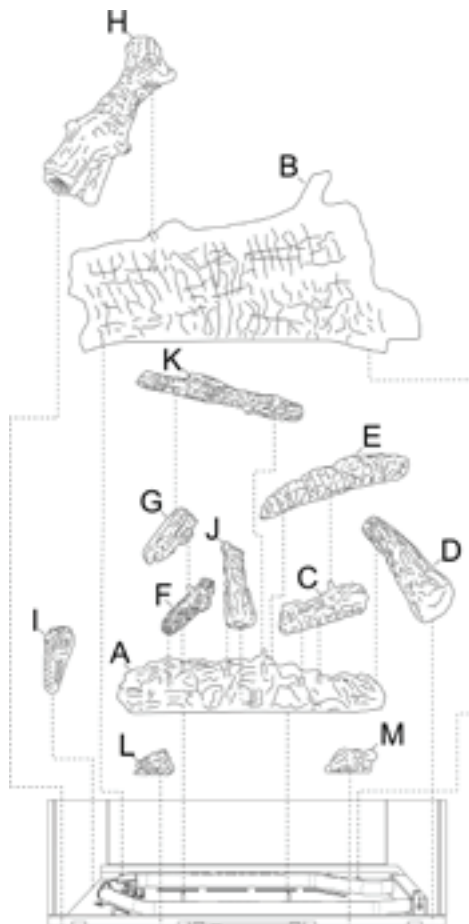

Figure 1

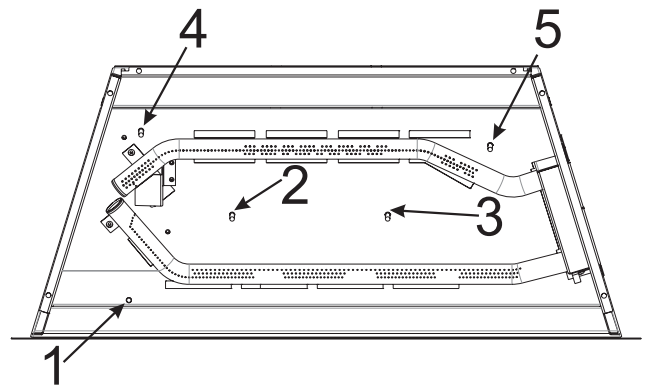

Figure 2

Glowing Embers Information

- Carefully separate the ember material into small amounts (no larger than "quarter-size" pieces).
 - Fluffed up pieces of ember material one layer thick will produce the best ember glow. Do not place more than one layer of ember material onto the burner. Excess ember material will decrease the ember glow effect.
 - Save any remaining ember material for future applications (as needed).

NOTICE: You may place logs A & B prior to adding glowing embers on burners.

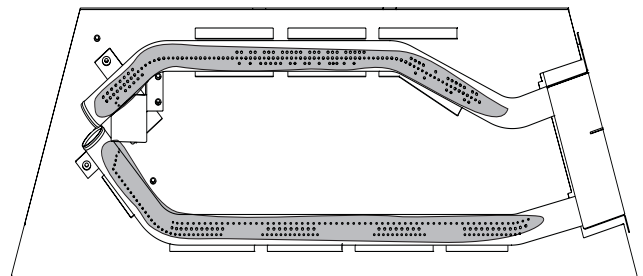

Figure 3

Coal Information

- Coals may be placed along the front burner (gray area) as shown in **Figure 4**. Do not place coals over burner ports.

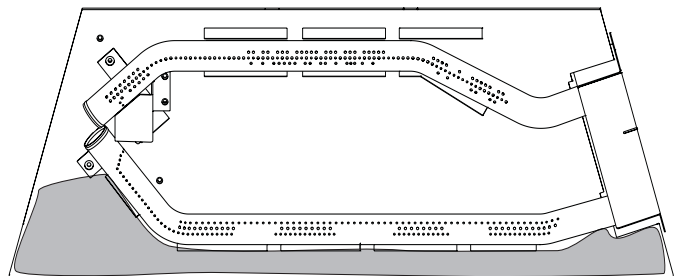

Figure 4

LOG AND EMBER PLACEMENT

1. Place **Ember Bed (A)** between burner using **Pins 2 and 3** as shown. You may elect to place glowing embers along the back burner at this time.



TOP VIEW



FRONT VIEW

LOG PLACEMENT

2. Place **Rear Log (B)** onto burner **Pins 4 and 5** as shown.



TOP VIEW

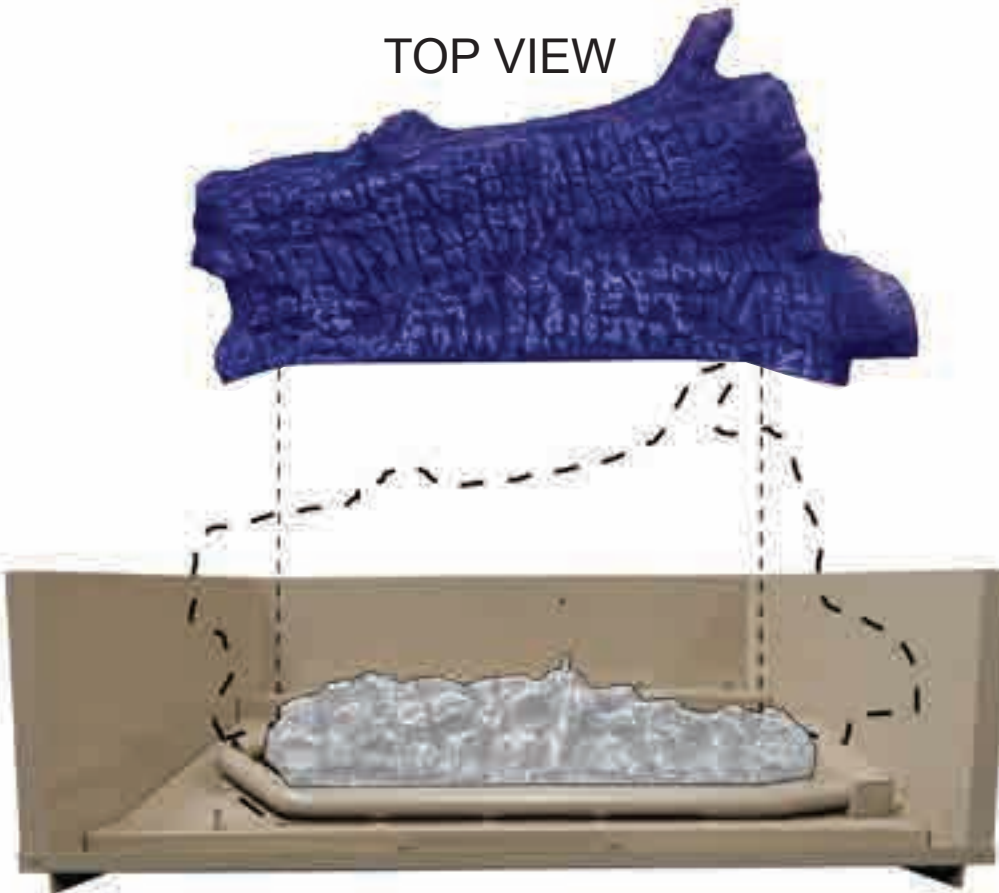

FRONT VIEW

LOG PLACEMENT

3. Place **Lower Right Log (C)** onto pin on **Ember Bed (A)** as shown.



TOP VIEW



FRONT VIEW

LOG PLACEMENT

4. Place **Right Log (D)** on right side of **Rear Log (B)** as shown.



TOP VIEW

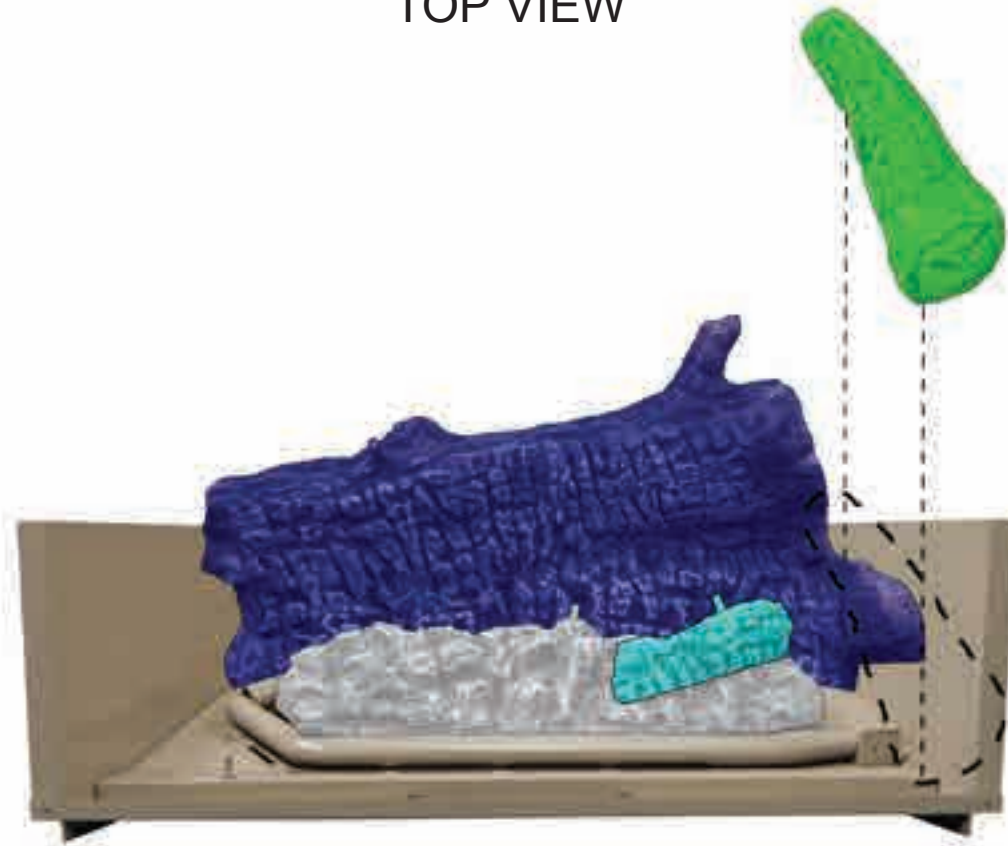

FRONT VIEW

LOG PLACEMENT

5. Place **Upper Right Log** onto pin in **Lower Right Log (C)** as shown.



TOP VIEW

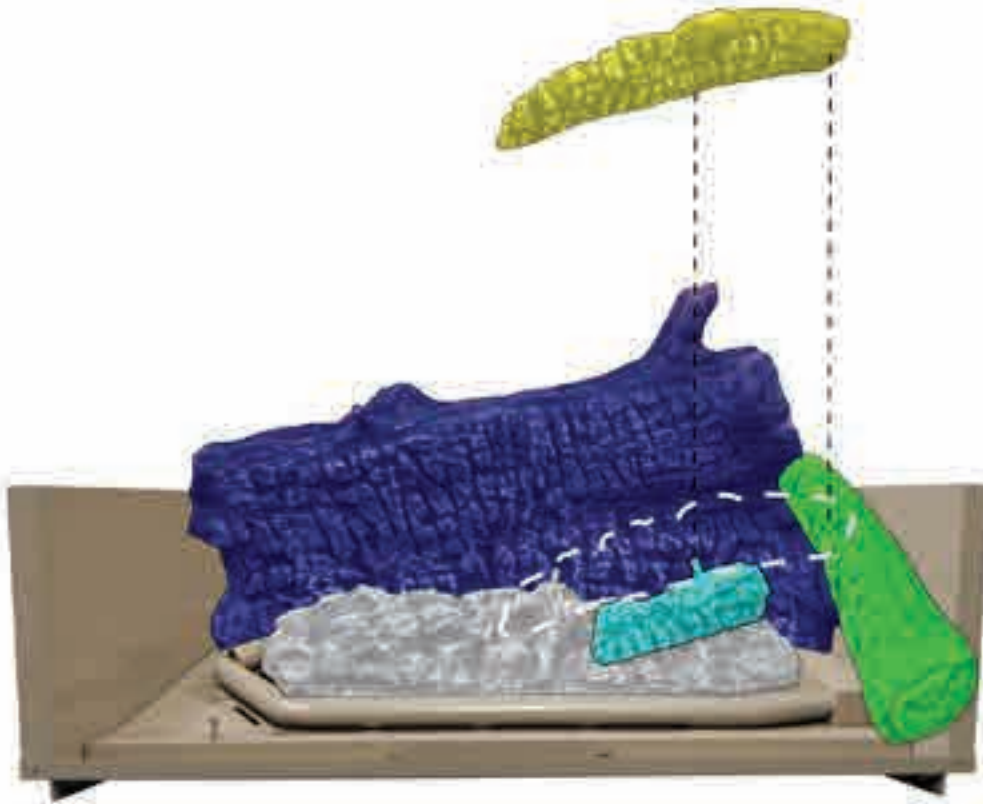

FRONT VIEW

LOG PLACEMENT

6. Place **Lower Left Log (F)** onto pin in **Ember Bed (A)** as shown.



TOP VIEW



FRONT VIEW

LOG PLACEMENT

7. Place **Left Log (G)** onto pin in **Lower Left Log (F)** as shown.



TOP VIEW



FRONT VIEW

LOG PLACEMENT

- Place **Upper Left Log (H)** onto pin in **Rear Log (B)** and **Pin (1)** in base as shown.



TOP VIEW

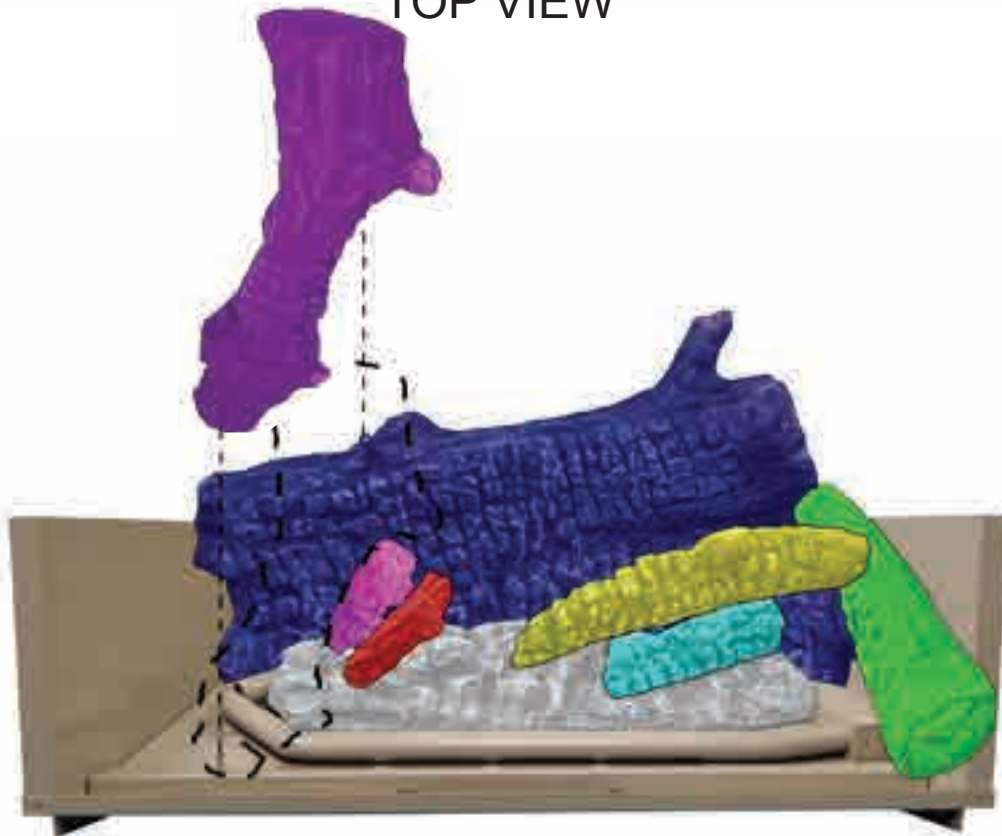

FRONT VIEW

LOG PLACEMENT

9. Place **Left Crossover Log (I)** onto pin in **Upper Left Log (H)** as shown.



TOP VIEW



FRONT VIEW

LOG PLACEMENT

10. Place **Center Log (J)** onto pin in **Ember Bed (A)** as shown.



TOP VIEW



FRONT VIEW

LOG PLACEMENT

11. Place **Center Crossover Log (K)** onto pin in **Upper Left Log (H)** and pin in **Ember Bed (A)** as shown.



TOP VIEW



FRONT VIEW

LOG PLACEMENT

12. Place **Left Front Log (L)** as shown.



TOP VIEW

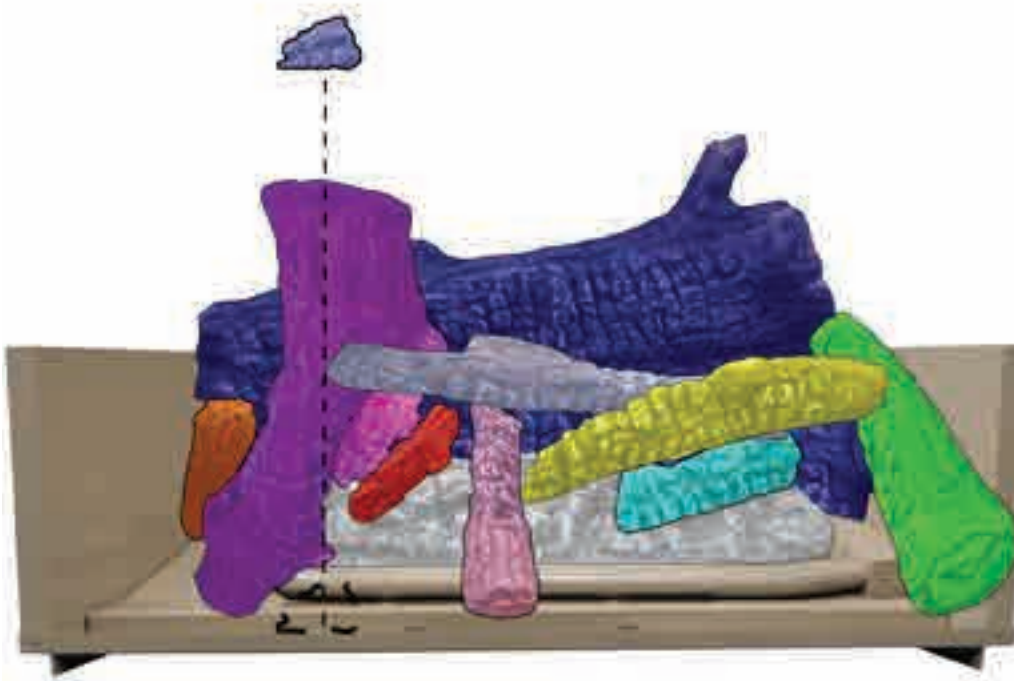

FRONT VIEW

LOG PLACEMENT

13. Place **Right Front Log (M)** as shown.



TOP VIEW



FRONT VIEW

LOG PLACEMENT

14. Place **Decorative Coals** along the front and sides of burner. **DO NOT** cover burner ports. The log set is complete.



TOP VIEW



FRONT VIEW

MASTER PARTS DISTRIBUTOR LIST

To Order Parts Under Warranty, please contact your local Empire dealer. See the dealer locator at www.empirecomfort.com. To provide warranty service, your dealer will need your name and address, purchase date and serial number, and the nature of the problem with the unit.

To Order Parts After the Warranty Period, please contact your dealer or one of the Master Parts Distributors listed below. This list changes from time to time. For the current list, please click on the Master Parts button at www.empirecomfort.com. Please note: Master Parts Distributors are independent businesses that stock the most commonly ordered Original Equipment repair parts for Heaters, Grills, and Fireplaces manufactured by Empire Comfort Systems Inc.

Dey Distributing

1401 Willow Lake Boulevard
Vadnais Heights, MN 55101

Phone: 651-490-9191

Toll Free: 800-397-1339

Website: www.deydistributing.com

Parts: Heater, Hearth and Grills

F. W. Webb Company

200 Locust Street
Hartford, CT 06114

Phone: 860-722-2433

Toll Free: 800-243-9360

Fax: 860-293-0479

Toll Free Fax: 800-274-2004

Websites: www.fwwebb.com & www.victormfg.com

Parts: Heater, Hearth and Grills

East Coast Energy Products

10 East Route 36
West Long Branch, NJ 07764

Phone: 732-870-8809

Toll Free: 800-755-8809

Fax: 732-870-8811

Website: www.eastcoastenergy.com

Parts: Heater, Hearth and Grills

HOW TO ORDER REPAIR PARTS

Parts Not Under Warranty

Parts can be ordered through your Service Person, Dealer, or a Master Parts Distributor. See this page for the Master Parts Distributors list. For best results, the **service person or dealer** should order parts through the distributor. Parts can be shipped directly to the **service person/dealer**.

Warranty Parts

Warranty parts will need a proof of purchase and can be ordered by your Service Person or Dealer. Proof of purchase is **required** for warranty parts.

All parts listed in the Parts List have a Part Number. When ordering parts, first obtain the Model Number and Serial Number from the name plate on your equipment. Then determine the Part Number (**not** the Index Number) and the Description of each part from the following illustration and part list. Be sure to give all this information . . .

Appliance Model Number _____ Part Description _____

Appliance Serial Number _____ Part Number _____

Type of Gas (Propane or Natural) _____

Do not order bolts, screws, washers or nuts. These standard hardware items can be purchased at any local hardware store.



SINCE 1932

www.empirecomfort.com

**Empire Comfort Systems Inc.
Belleville, IL**

If you have a general question
about our products, please e-mail
us at info@empirecomfort.com.

If you have a service or repair
question, please contact your dealer.