

Coyote Stainless Steel Side Burner Use & Care Manual

For Liquid Propane and Natural Gas Models



C1PB Power Burner



Conforms to ANSI STD Z21.58-2015
Certified to CSA STD 1.6-2015
Outdoor Cooking Gas Appliance

For Outdoor Use Only

PUT SERIES NO. LABEL HERE

IMPORTANT: Read all instructions and warnings before using this product! Use of this product, as with any similar outdoor grill, will involve risks from high temperatures and from exposure to smoke and fumes. Please exercise caution and common sense.

To installer or person assembling grill: Leave this manual with grill for future reference.

To consumer: Keep this manual for future reference as it contains important Warnings and Instructions.

COYOTE OUTDOOR LIVING, INC.

Scan QR Code for brief
safety and installation
video.



Welcome & Congratulations

Congratulations on your purchase of a new side burner! We are very proud of our product and we are completely committed to providing you with the best service possible. Your satisfaction is our #1 priority.

Please read this manual carefully to understand all the instructions about how to install, operate and maintain your side burner for your safety and for optimum performance and longevity.

We know you'll enjoy your new side burner and thank you for choosing our product. We hope you consider us for future purchases.

Read and save the instructions

Obey all Warnings and Instructions.

This Manual provides specific operating instructions for your model. Use your side burner only as instructed in this manual. These instructions are not meant to cover every possible condition and situation that may occur. Common sense and caution must be practiced when installing, operating and maintaining any appliance. If you lose this Manual, a replacement copy can be downloaded from our website at www.coyoteoutdoor.com or call Customer Service at 855-520-1559.

Table of Contents

Safety Instructions	2
Limited Warranty.....	5
Locating the Side burner	7
Gas Requirements.....	11
Operating the Side Burner.....	17
Lighting Instructions.....	18
Using your Burner / Cooking Safely.....	19
Care and Maintenance.....	20
Troubleshooting your Side Burner.....	24
Parts Listings.....	26

DANGER

IF YOU SMELL GAS:

1. Shut off gas to the appliance.
2. Extinguish any open flame.
3. Open Lid.
4. If odor continues, keep away from the appliance and immediately call your gas supplier or your fire department.

Safety Symbols

DANGER

DANGER indicates an imminently hazardous situation which, if not avoided, will result in death or serious injury.

WARNING

WARNING:

1. DO NOT store or use gasoline or other flammable liquids or vapors in the vicinity of this or any other appliance.
2. A Liquid Propane (LP) cylinder not connected for use shall not be stored in the vicinity of this or any other appliance.

CAUTION

CAUTION indicates a potentially hazardous situation which, if not avoided, may result in minor or moderate personal injury, or property damage.

WARNING

FOR OUTDOOR USE ONLY:



NEVER operate a side burner in enclosed areas, as this could lead to gas accumulating from a leak, causing an explosion or a carbon monoxide buildup which could result in injury or death. DO NOT use your side burner in garages, breezeways, sheds or any enclosed area. NOT FOR USE BY CHILDREN. If these instructions are ignored, a hazardous fire or explosion could result in physical injury, death or property damage!

WARNING

WARNING indicates a potentially hazardous situation which, if not avoided, could result in death or serious injury.



Important Warnings and Safety Instructions

 **WARNING**  Improper installation, adjustment, alteration, service, maintenance or use can cause injury or property damage. Read the installation, operating and maintenance instructions thoroughly before installation or servicing of this equipment.

General Safety Instructions



1. **For Outdoor Use Only.**
2. Coyote side burners are only intended for residential use and are not intended for commercial use, where anyone other than the original purchaser (homeowner) would be using and maintaining the side burner.
3. **NEVER** use indoors or in any type of enclosed area, such as a garage, shed or breezeway. Keep clear of trees and shrubs. The side burners are not intended for installation in or on recreational vehicles, portable trailers, boats or any other moving installation.
4. To reduce the risk of serious or fatal injury from breathing toxic fumes and from explosion and fire as a result of leaking gas, use only outdoors in an open area with good ventilation. **NEVER** obstruct the flow of combustion and ventilation air.
5. **Fire Hazard:** The area surrounding your new side burner should be kept clean and free from flammable liquids and other combustible materials such as mops, rags or brooms, as well as solvents, cleaning fluids, lighter fluid and gasoline.
6. **NEVER** use the side burner in windy conditions. If located in a consistently windy area (oceanfront, mountaintop, etc.), a wind break will be required. Always adhere to the specified clearances listed in this Manual on page 9.
7. **NEVER** leave the side burner unattended while cooking.
8. **Risk of Explosion:** **NEVER** use natural gas in a unit designed for liquid propane gas or vice versa.
9. Do not use lighter fluid in a gas side burner.
10. **NEVER** allow children to use or play near the side burner. Keep children and pets away from a hot side burner at all times
11. Installation and any repairs or replacement of parts should be performed by a qualified service technician. If you are not qualified to install, repair, or replace parts of your side burner, please retain a qualified professional contractor or technician to do so.
12. **Burn Hazard:** **NEVER** lean over an open side burner. Do not place clothing or other flammable material on or near the side burner. Do not wear loose-fitting clothes or long sleeves while using the side burner as some fabrics can be highly flammable and, if ignited, may result in personal injury or death.
13. **Burn Hazard:** When using the side burner, do not touch the side burner rack, burner grate, or immediate surroundings as these areas become extremely hot and can cause burns. Always use a covered/gloved hand when opening the side burner hood and only do so slowly to allow heat and steam to escape.
14. **ALWAYS:** have an ABC fire extinguisher accessible.
15. **NEVER** attempt to extinguish a grease fire with water or other liquids as this may cause a flashback that could result in personal injury or death.
16. **NEVER** use aluminum foil to line the side burner racks or the drip trays, this can alter airflow for proper

combustion and also build up heat in the control area causing the knobs and cause damage to the igniter.

17. NEVER allow grease or other hot material to drip from the side burner onto the valve, hose, or regulator. If that occurs, turn off the fuel supply immediately. After the side burner has cooled, determine the cause of the dripping and correct it. After cleaning the valve, hose and regulator, perform a soapy water leak test before continuing use. If a leak is discovered, call a qualified technician for service.
18. NEVER heat any unopened glass or metal container of food on the side burner. Pressure may build up and cause the container to burst, possibly resulting in death, serious personal injury, or property damage.
19. ALWAYS: Keep any electrical supply cords away from water or heated surfaces. Electrical cords should be placed away from walkways to avoid tripping hazard.
20. ALWAYS: Keep gas supply lines as short as possible.
21. NEVER move the side burner when hot.
22. NEVER use side burner while under the influence of drugs or alcohol.
23. NEVER store a spare gas cylinder under or near your side burner.
24. **Fire Hazard:** NEVER side burner without the drip tray in place; hot grease could leak downward and produce a fire or an explosion. Drip tray should be pushed all the way to the rack located just under the side burner.
25. **Fire Hazard:** Grease is extremely flammable. Let hot grease cool down before attempting to handle or dispose of it. After use and cool-down, the drip tray should be cleaned on a regular basis and kept free of grease.
26. In the event that a burner goes out, turn burner knobs to the full OFF position, fully open the side burner hood and let it air out. NEVER attempt to use the side burner until the gas has had time to dissipate.
27. Do not use a side burner until a leak check has been completed.
28. ALWAYS: Turn off the LP cylinder tank valve when your side burner is not in use.
29. ALWAYS: Ensure the control knobs are in the "OFF" position when not in use.
30. ALWAYS: Use only a Ground Fault Interrupter (GFI) protected circuit with this outdoor cooking gas appliance.

 **WARNING** 

DO NOT RELY JUST ON THIS SAFETY SECTION. USE CAUTION AND COMMON SENSE AT ALL TIMES.

PLEASE READ THE REST OF THIS MANUAL CAREFULLY FOR OTHER IMPORTANT SAFETY WARNINGS.

CALIFORNIA PROPOSITION 65 - WARNING: This product can expose you to Carbon Monoxide, which is on the list of substances known by the state of California to cause cancer, birth defects or reproductive harm. For more information go to: www.p65warnings.ca.gov. California law requires businesses to warn customers of potential exposure to such substances. To minimize exposure to these substances, always operate this unit according to the Use and Care Manual, ensuring you provide good ventilation when cooking with gas.



Limited Warranty

TO THE MAXIMUM EXTENT PERMITTED BY LAW, THIS LIMITED WARRANTY AND THE REMEDIES SET FORTH BELOW ARE EXCLUSIVE AND IN LIEU OF ALL OTHER WARRANTIES, REMEDIES AND CONDITIONS, WHETHER ORAL OR WRITTEN, EXPRESS OR IMPLIED. TO THE MAXIMUM EXTENT PERMITTED BY LAW, COYOTE OUTDOOR LIVING, INC. ALSO SPECIFICALLY DISCLAIMS ANY AND ALL IMPLIED WARRANTIES, INCLUDING, WITHOUT LIMITATION, WARRANTIES OF MERCHANTABILITY AND FITNESS FOR A PARTICULAR PURPOSE.

Coyote Outdoor Living, Inc. issues this limited warranty to the original purchaser at the original site of delivery with proof of purchase and specifically warrants that the Outdoor Gas side burner when subject to normal residential use, will be free from defects in workmanship and materials for the periods specified below. This limited warranty is not transferable and specifically excludes any side burner used in a commercial setting, where anyone other than the original purchaser (homeowner) would be using and maintaining the side burner. This limited warranty specifically excludes all issues that may arise from surface corrosion, scratches, and discoloration during regular use. This limited warranty does **NOT COVER LABOR OR LABOR RELATED CHARGES** and there will be shipping and handling charges for the delivery of part(s).

<u>COMPONENT</u>	<u>WARRANTY PERIOD</u>
Burners & Cooking Grids (no rust or burn through)	5 years (limited)
Flavorizer Bars (no rust or burn through).....	2 years (limited)
Ignition systems/Valves	1 year (limited)
Stainless steel frame/housing	Limited Lifetime

Coyote Outdoor Living, Inc.'s obligation under this limited warranty is limited solely to repair or replacement, at our option, of the pertinent component during the warranty period, and the extent of any liability of Coyote Outdoor Living, Inc. under this warranty is limited to repair or replacement. This limited warranty does not cover normal wear of parts or damage resulting from any of the following: negligent use or misuse of the product, use of an improper fuel/gas supply, use contrary to operating instructions, or alteration by any person other than a factory service center. The above warranty periods are not extended by any repair or replacement.

WARRANTY CLAIM PROCEDURE: If you require service or parts for your Coyote Side burner, please contact our Warranty Service Center for factory direct assistance. Our hours of operation are 8 am to 4:30 pm CST. The phone number is 855.520.1559 and the email address is support@coyoteoutdoor.com. You may also fill out warranty claims online at www.coyoteoutdoor.com. Please have your model number, serial number and proof of purchase available for any warranty claim.

Coyote Outdoor Living, Inc. may require the return of defective parts for examination before issuing replacement parts. If you are required to return defective parts, shipping charges must be prepaid by the

customer. Upon examination and to Coyote Outdoor's determination, if the original part is proven defective, Coyote Outdoor may approve your claim and elect to replace such parts without charge. In every instance, the customer is responsible for shipping and handling of replacement parts. Component repair or replacement is the exclusive remedy under this limited warranty and Coyote Outdoor shall not be liable for any incidental or consequential damages.

This limited warranty does not cover any failures or operating difficulties due to accidents, abuse, misuse, alteration, misapplication, vandalism, improper installation, maintenance or service, or damages caused by flashback fire or grease fire. This limited warranty does not cover scratches, dents, corrosion or discoloration caused by weather, heat, abrasive and chemical cleaners, pool or spa chemicals, and/or any tools used in the assembly or installation of this unit. This limited warranty does not cover paint loss, surface rust, corrosion or stainless steel discoloration which is considered normal wear and tear. This limited warranty does not cover the cost of any inconvenience, personal injury, or property damage due to improper use or product failure. Deterioration or damage due to severe weather conditions such as hail, hurricanes, earthquakes, tsunamis, tornadoes, terrorism, discoloration due to exposure to chemicals either directly or in the atmosphere, Acts of God/forces of Nature are not covered by this limited warranty.

Locating the Grill

Check your local building codes for the proper method of installation. In the absence of local codes, this unit should be installed in accordance with the *National Fuel Gas Code No. Z223.1-1998 USA* or *CAN/CGA-B149.1/.2 Natural Gas/Propane Code (Canada)* latest edition or the *National Electrical Code ANSI/NFPA No. 70* or the *Canadian Electrical Code CSA C22.1, 1990* or latest version.

- Before installing built-in side burners in enclosures, copy all product information such as model number, serial number and type of side burner (e.g. natural gas or LP) and store information in a safe place.
- If the side burner is installed by a professional installer or technician, be sure that he or she shows you where your gas supply shut-off is located. All gas lines must have a shut-off that is readily and easily accessible. If you smell gas, check for gas leaks immediately. Check only with a soap and water solution. Never check for gas leaks with an open flame.

Notice: We strongly recommend professional installation of your Coyote side burner. These instructions provide the measurements necessary to construct a masonry structure to house your outdoor gas side burner.

IMPORTANT: Gas fittings, regulator, and installer supplied shut-off valves must be easily accessible.

LOCATION OF YOUR SIDE **DANGER** BURNER:



Locate the side burner only OUTSIDE in a well-ventilated area. **Never locate the side burner in a building, garage, breezeway, shed or other such enclosed areas without an approved ventilation system.** When in use, the side burner will generate a lot of smoke. When installing your side burner, select an outdoor location that will ensure there is adequate area for the smoke to dissipate IN ORDER TO AVOID INHALATION OF POTENTIALLY TOXIC FUMES.

Ventilation Requirements for Proper Operation of your Coyote Side burner

- Ventilation for a gas side burner is absolutely mandatory to ensure that your side burner performs as intended and to ensure the safety of you, your family, and guests. Proper ventilation is necessary to allow heat inside your side burner to escape and also to allow any gas that has leaked from a tank or connection to escape before a buildup of such gas can occur and possibly ignite.



Failure to provide proper ventilation will nullify Coyote's warranty and will cause a risk of bodily injury or death.

- If you elect to install your side burner into an island, the island itself must be ventilated properly. Any such island must have a minimum of 2 vents (but optimally 4 vents) per cabinet that has any sort of gas supply or connection. Each vent must be at least 20 sq. in in size and have access to outside/fresh air. Those vents will allow heat that is trapped inside due to wind to be able to dissipate out of the island vents. However, if the island is not ventilated properly and the wind is coming from the back, then the heat will try to escape through the easiest exit, which will most likely be through the bottom of the side burner and front control panel.  **WARNING** 

- A simple way to think of what is occurring inside your side burner is that when your burners are on, they are emitting a flame that creates the heat to cook your food. This heat must exhaust or escape from the side burner, otherwise you would eventually have a unit that would not only build up intense heat but also dangerous pressure. This could cause severe damage to not only the side burner but any operators



or people or property near-by. The side burner itself allows for ventilation mainly through the rear of the unit above the rear panel but below the top of the hood. However, wind can act as a barrier to ventilation and exhaust. This blockage of exhaust can cause problems and hazardous conditions. Therefore, great care must be taken in selecting a location for your side burner and in the installation of it into any masonry island or other outdoor structure. This can cause the control panel and knobs to get hot to the touch and possibly even burn your fingers, not to mention that it can melt all rubber gaskets on the valves and damage the ignition system to where it will need full replacement.

- Ventilation and typical wind direction and conditions must always be considered when planning your outdoor cooking island. Just the same as you would plan the layout and measure your indoor kitchen, you must also do the same for the outdoors; but you cannot forget about Mother Nature and the effects she can have on your outdoor cooking equipment.

Clearance:

- **FROM NON-COMBUSTIBLE MATERIALS:** Coyote side burners can be placed directly on, or adjacent to, non-combustible materials, subject to ventilation requirements. The hood on a Coyote side burner pivots mainly on the body. If you have a wall or partition behind the unit that would block ventilation, then a minimum of 7" clearance from the back of the side burner to the wall is needed for the purpose of ventilation. If you do not have a wall or partition blocking the ventilation of the unit, then you only need an extra 2" behind the unit for the hood to open fully. If you wish to use the rotisserie option, you will want to make sure that you leave adequate space (at least 6") on each side of the side burner so that the motor and rotisserie spit handle will have room on the counter, as these extend past the overall dimensions of the side burner body.
- **FROM COMBUSTIBLE MATERIALS:** Coyote side burners must have at least 24" clearance from any combustible materials (in any direction) for the safety of the homeowner and for any Coyote Warranty to remain in effect. 
 - You CANNOT locate the side burner under any combustible material without an approved ventilation system located directly above the unit. To elaborate, Coyote defines an approved ventilation hood as:
 - The ventilation hood chosen must be UL certified, produced for outdoor use and must be installed according to the hood manufacturer's specifications.
 - The hood must be installed at least 30" above the top of the cooking surface.
 - The hood must be at least 6" wider than the side burner's frame (3" on each side), not just the cooking surface.
- **INSULATED JACKETS AND COMBUSTIBLE CONSTRUCTION:** If you elect to use combustible material to build your side burner island AND the side burner will be located within 24" of the combustible material, then you must use the appropriate Coyote insulated jacket. The insulated jacket will act as a barrier to protect your side burner island from the heat and fire of your Coyote side burner. If an insulated jacket is not used in a combustible material island, the warranty on the Coyote side burner will be voided immediately and safety cannot be ensured.

For Built-in Installations

A built-in side burner is designed for easy installation into masonry enclosures. For non-combustible applications, the side burner drops into the opening (as shown in cut-out detail drawing - Fig. A) and hangs from the side

burner body itself. A bottom deck is not required to support the side burner from the bottom. It is also required that:

- A minimum of two ventilation holes in the enclosure, of at least 20 sq. inches in size (per vent), must be present to help release any leaking gas from the enclosure.
 - As Propane is heavier than air, for propane side burners locate your vents at the tank valve height or lower
 - As Natural Gas is lighter than air, for natural gas side burners locate your vents at the gas connection height or higher
- The counter should be flat and level relative to the floor.

⚠ WARNING ⚠ *LP TANK STORAGE MUST BE ISOLATED IN A SEPARATE COMPARTMENT FROM THAT OF THE SIDE BURNER AND IT MUST BE VENTED AS WELL. (RECOMMEND BOTTOM VENTS FOR LP)*

The two top illustrations demonstrate how the slide-in type unit is designed to fit into open- front enclosures, and supported at the Countertop.

Do not install this unit under unprotected flammable surfaces. Do not install or use this appliance inside a building, garage, or any other covered area. It must not be used in or on recreational vehicles or boats.

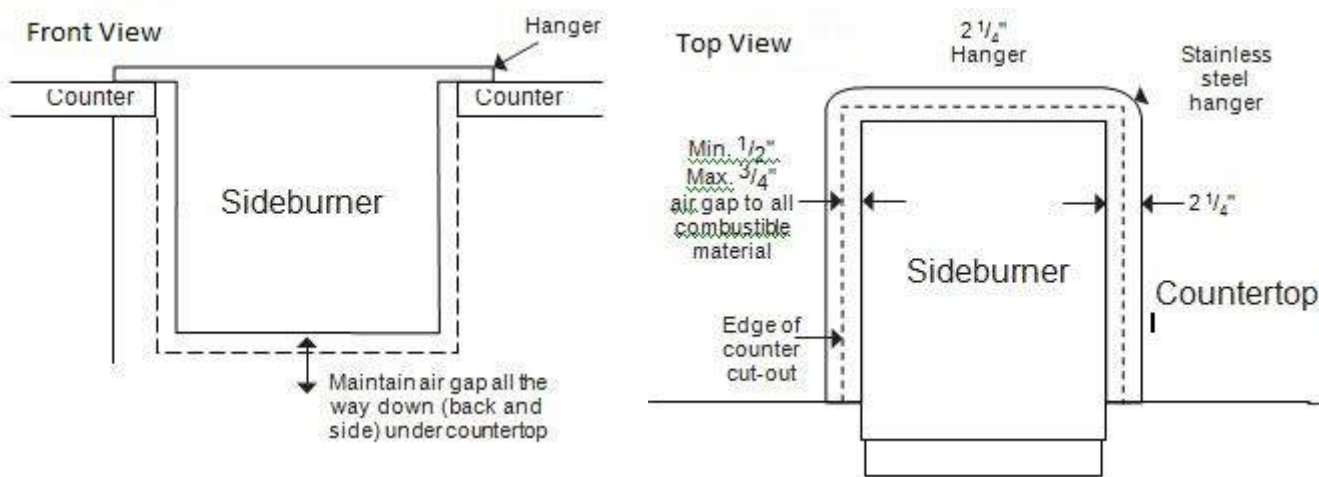

High Elevation Installation and Use

Coyote Side burners are designed to operate most efficiently at 0-2000 feet above sea level. From 2000-4000 feet above sea level you will not notice any substantial decrease in your heat, although more gas is combusting within the burners due to less oxygen. Above 4000 feet, you may experience longer cooking times on your side burner than experienced at sea level. This is due to the air/fuel mixture taking place within the burners. If you have questions or concerns regarding your location or elevation, please contact Coyote Customer Service for assistance.



Cut out Dimensions Figure A

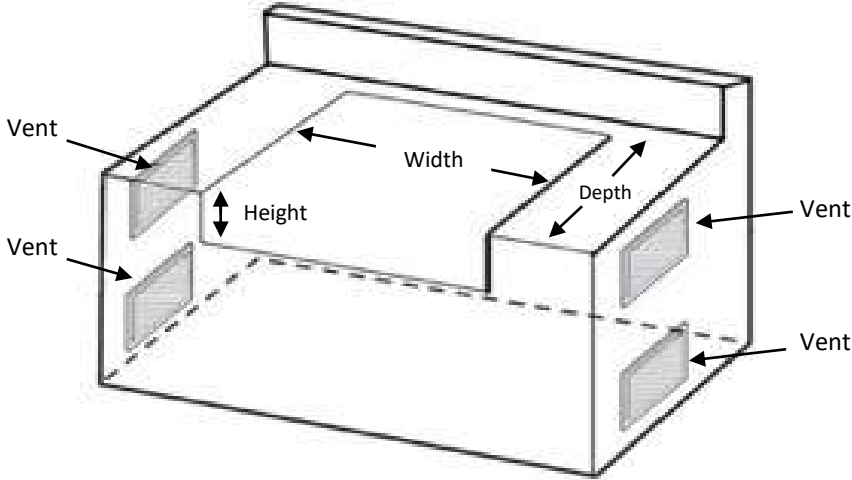

⚠ DANGER ⚠

Minimum of 2 vents, *but* connection. Each vent must have any sort of gas supply or access to outside/fresh air. Two vents on each side will facilitate and improve airflow and ventilation.

Scan QR Code for brief safety and installation video.



Model	Cutout Dimensions			Overall Dimensions			Total BTU Ratings		Electrical Outlets Needed (110V)	
	Height	Width	Depth	Height	Width	Depth	LP	NG	Rotisserie	Lights
C1PB	10 1/4"	21"	21"	13"	24"	24 1/4"	60,000	60,000	No	No

Scan QR Code for brief safety and installation video.



Gas Requirements

NOTE: Coyote strongly recommends that a qualified service technician perform the initial installation and all conversions or modifications to the gas supply.



Never attach an unregulated gas line to the appliance. Connection to an unregulated gas line can cause excessive heat or fire and the risk of property damage, bodily injury, or death.

IMPORTANT: Before connecting side burner to gas source, make sure side burner control knobs are in the “OFF” position.

- Verify the type of gas supply to be used, either natural or liquid propane, and make sure the marking on the appliance rating label agrees with that of the gas supply. Do not connect a Coyote liquid propane gas side burner to a natural gas supply, and do not connect a Coyote natural gas side burner to a liquid propane gas supply.
- All pipe sealants must be an approved type and resistant to the actions of LP gas. Never use pipe sealant on flare fittings.
- *The installation of this appliance must conform with local codes or, in the absence of local codes, with either National Fuel Gas Code, ANSI Z223.1/ NFPA 54, Natural Gas and Propane Installation Code, CSA B149.1, or Propane Storage and Handling Code, B149.2, or the Standard for Recreational Vehicles, ANSI A 119.2/ NFPA 1192M, and CSA Z240 RV Series, Recreational Vehicle Code, as applicable.*



Gas valves are preset at the factory to operate on liquid propane or natural gas. If you wish to convert, be sure to contact your side burner dealer FIRST!

Liquid Propane Gas Supply

Always check the rating plate to make sure gas supply to which you connect the side burner is the gas type for which the side burner is manufactured. A Coyote liquid propane (LP) gas side burner is designed to operate on propane gas ONLY, at a pressure regulated at 11” (279.4mm) water column (W.C.) when equipped with the correct propane orifices on the valves and a propane regulator on the supply line regulated at the residential meter. A Coyote liquid propane gas side burner comes with a propane regulator that is designed to be used with a standard 20 lb. gas cylinder and those cylinders must be constructed and marked in accordance with specifications of the US Department of Transportation for propane gas cylinders.



- Liquid propane (LP) gas is flammable and hazardous if handled improperly. Know its characteristics



- before using any propane products.
- Propane characteristics include: flammable, explosive under pressure, heavier than air and settles in pools and low areas.
 - In its natural state, propane has no odor. For your safety, an odorant typically is added. ALWAYS purchase or refill your propane tanks from a reputable propane gas supplier.
 - Contact with propane can cause freeze burns to the skin.
 - NEVER use a propane cylinder with a damaged body, valve, collar or footing.
 - A dented or rusted propane cylinder may be hazardous.
 - Always keep LP cylinder securely fastened in an upright position.
 - Never connect an unregulated propane gas cylinder to the side burner.
 - NEVER subject (expose) propane cylinders to excessive heat.

⚠ CAUTION ⚠

- Never store a LP gas cylinder inside a building or in the vicinity of any gas-burning appliance.

Cylinder Specifications

⚠ CAUTION ⚠

- Any L.P. gas supply cylinder used with this side burner must be approximately 12 inches diameter and 18 inches high. The maximum fuel capacity is 80% and is approximately 20 pounds of propane.
- The L.P. cylinder must have a shut-off valve (see picture) terminating in a Type 1 L.P.
- A Type 1 compatible cylinder with a Type 1 cylinder valve has a back-check valve which does not permit gas flow, until a positive seal has been obtained.
- The cylinder must be arranged for vapor withdrawal. It must also include a collar to protect the cylinder valve. A safety relief device having direct communication with the vapor space of cylinder must be provided. This will expel high pressure gas if the cylinder is overfilled or overheated which could result in fire or explosion.
- All L.P. gas cylinders used with this appliance shall be constructed and marked in accordance with the specifications for L.P. gas cylinders of the U. S. Department of Transportation (DOT) or the *National Standard of Canada, CAN/CSA-B339, Cylinders, Spheres and Tubes for Transportation of Dangerous Goods; and Commission, as applicable; and shall be provided with a listed overfilling prevention device.*
- Read labels on the L.P. Gas Supply Cylinder.
- New cylinders are always shipped empty for safety.
- Allow only qualified L.P. gas dealers to fill or repair your L.P. gas supply cylinder.
- Inform the gas dealer if it is a new or used cylinder to be filled.
- After filling, have the gas dealer check for leaks and to see that the relief valve remains effective and in good repair.

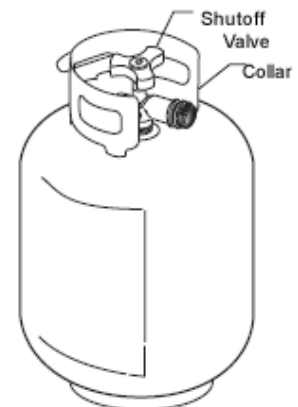

Hose and Regulator (Comes standard with the side burner)

The Type 1 connection system has the following features:

- The system will not allow gas to flow until a positive connection has been made.

⚠ CAUTION ⚠

The cylinder control valve must be

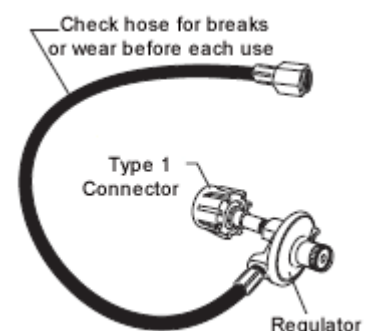

turned off before any connection is made or removed.

- The system has a thermal element that will shut off the flow of gas in the event of a fire.
- The system has a flow limiting device which, when activated, will limit the flow of gas to 10 cubic feet per hour.
- **NEVER** use side burner without leak testing this connection.

LP (Propane) Gas Supply Connection

1. The tank valve should be in the "OFF" position. If not, turn the knob clockwise until it stops.
2. Make sure all burner valves are in the "OFF" position.
3. Always connect the gas supply regulator as follows:
Insert the regulator inlet into the tank valve and turn the coupling nut clockwise until the coupler tightens up (see picture). Do not over-tighten the coupler. Turn the main tank valve on, and turn the burner control valves on the unit to the "HIGH" position for about 20 seconds to allow the air in the system to purge before attempting to light the burners.



Pre-Operation Leak Testing

⚠ DANGER ⚠

1. Do not insert any tool into the valve outlet or safety relief valve. You may damage the valve and cause a leak. Leaking propane may result in explosion, fire, severe personal injury, or death.
2. If a leak is detected at any time, or you cannot stop a gas leak, immediately close the tank's shut-off valve (gas supply from LP tank to the Side burner) and call LP gas supplier or your fire department!
3. Check all gas supply fittings before each use and each time the gas supply cylinder is connected to the regulator. Have a qualified service technician leak test the side burner any time a part of the gas system is replaced.

⚠ WARNING ⚠

Never attempt to attach this side burner to the self-contained LP gas system. Do not use the side burner until leak testing has been completed.

Leak Testing Valves, Hose and Regulator

1. NEVER smoke while leak testing.
2. Extinguish all open flames. Never leak test with an open flame.
3. Mix a solution of equal parts mild detergent or liquid soap and water.
4. Turn all side burner control knobs to OFF.
5. Ensure that the connections from the regulator to the side burner and tank are tight and secure (see picture).

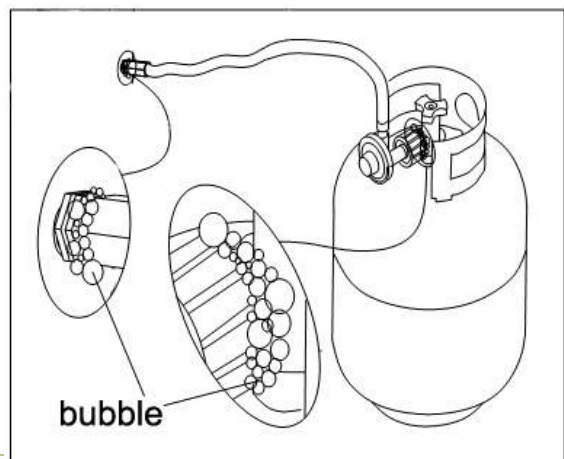

6. Completely open LP tank valve by turning cylinder valve knob counterclockwise (right to left). If you hear a rushing sound, turn gas off immediately. There is a major leak at the connection. Correct before proceeding by calling the Coyote Customer Service line at 855-520-1559.
7. If no rushing sound, brush soapy solution onto areas where bubbles are shown in LP tank (see picture).
8. If “growing” bubbles appear, there is a leak. Close LP tank valve immediately and retighten connections. If leaks cannot be stopped, do not try to repair the regulator, or tank valve, by yourself and contact the Coyote Customer Service line at 855-520-1559.
9. Always close LP tank valve after performing leak test by turning cylinder valve knob clockwise.

⚠ WARNING ⚠

NOTE: When leak testing this appliance, make sure to test and tighten all loose connections. A slight leak in the system can result in a low flame, or a hazardous condition that could result in a fire or explosion.

LP Gas Supply Cylinder Disconnection

In order to disconnect the LP tank from the side burner:

1. Turn the burner valves off.
2. Turn the tank valve off. (Turn shut-off clockwise to stop).
3. Detach the regulator assembly from the tank valve by turning the quick coupling nut counterclockwise.

LP Tank Removal, Transport and Storage

- Turn OFF all control knobs and LP tank valve. Turn coupling nut counterclockwise by hand only - do not use tools to disconnect. Install safety cap onto LP tank valve. Always use cap and strap supplied with valve.

⚠ WARNING ⚠ Failure to use safety cap as directed may result in serious personal injury and/or property damage.

A disconnected LP tank in storage or being transported must have a **safety cap** installed (as shown).

- Never leave a LP tank inside a motor vehicle. (Heating of the vehicle could cause an increase in the gas pressure which may open the release valve allowing gas to escape resulting a serious risk of fire or explosion.)
- Do not store an LP tank in enclosed spaces such as a carport, garage, porch, covered patio or other building.
- Do not store LP tank in an area where children play.

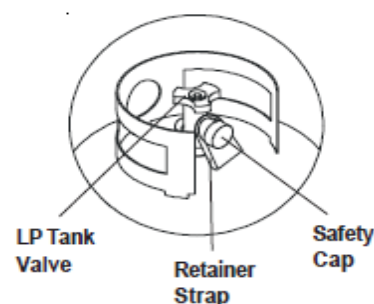

LP Tank Filling

- Use only licensed and experienced LP dealers.
- LP dealer must purge tank before filling.
- Dealer should NEVER fill LP tank more than 80% of LP tank volume. Volume of propane in tank will vary by temperature.
- A frosty regulator indicates gas overfill. If frosty, immediately close LP tank valve and call local LP gas dealer for assistance.
- Do not release liquid propane (LP) gas into the atmosphere. This is a hazardous practice.
- To remove gas from LP tank, contact an LP dealer or call a local fire department for assistance.

LP Tank Exchange

- Exchange your Type 1 cylinder for OPD safety feature-equipped replacement tank ONLY.
- Always keep new and exchanged LP tanks in upright position during use, transit or storage. Leak test new and exchanged LP tanks BEFORE connecting to side burner.

Large Capacity Propane Tanks and Homes:

- If your entire house is plumbed for propane gas use, and you have an exterior connection for such use, then a standard LP side burner from Coyote can be connected to such outdoor propane connection, but you must be aware of the following:
 - Coyote does not supply any gas fittings or lines, other than the regulator needed within the side burner box
 - All Coyote LP Side burners come with a 20lb tank regulator. This regulator cannot be used or modified to work on any other setup.
 - **⚠ WARNING ⚠** If you are running off of a large capacity tank (more than 20lbs), then an “in-line” LP regulator is needed, which can be purchased from any Coyote authorized dealer, or plumbing supply company. However, it is the responsibility of the owner/installer to verify that the correct regulator is purchased for the intended application and that it is installed properly.
 - As codes vary from state to state, it is the responsibility of the owner/installer to ensure that all county, state and federal codes are followed for any gas installation.

Natural Gas Supply

Always check the rating plate to make sure the gas supply to which you connect the side burner is the gas type the side burner is manufactured for.

⚠ CAUTION ⚠ A Coyote natural gas (NG) side burner is designed to operate on natural gas ONLY, at a pressure regulated at 4” (101.6mm) water column (W.C.) when equipped with the correct natural gas orifices on the valves and a natural gas regulator on the supply line regulated at the residential meter.

⚠ CAUTION ⚠ Never connect the side burner to an unregulated gas supply.

NATURAL GAS CONNECTIONS MUST BE PERFORMED BY A LICENSED CONTRACTOR OR LOCAL GAS COMPANY REPRESENTATIVE.

Natural Gas Regulator

⚠ WARNING ⚠ NEVER use side burner without leak testing this connection.

Natural gas regulator model: GR120

Gas pressure: 4” (101.6mm)

Maximum rate working pressure: 1/2 Psig



Leak Testing Valves, Hose and Regulator

1. NEVER smoke while leak testing.
2. Extinguish all open flames. Never leak test with an open flame.
3. Mix a solution of equal parts mild detergent or liquid soap and water.
4. Turn all side burner control knobs to OFF.
5. Ensure that the connections from the regulator to the side burner and tank are tight and secure.
6. Completely open the shut-off valve. If you hear a rushing sound, turn gas off immediately. There is a major leak at the connection. Correct before proceeding by calling the Coyote Customer Service line at 855-520-1559.
7. If no rushing sound, brush soapy solution onto all connection points.
8. If “growing” bubbles appear, there is a leak. Close the shut-off valve immediately and retighten connections. If leaks cannot be stopped, do not try to repair the regulator, or shut-off valve, by yourself and contact the Coyote Customer Service line at 855-520-1559.

NOTE: When leak testing this appliance, make sure to test and tighten all loose connections. A slight leak in the system can result in a low flame, or a hazardous condition that could result in a fire or explosion.

Natural Gas Supply and Connection

1. Make sure all burner valves are in the “OFF” position
2. All NG units need to have a regulator and shut-off valve on the supply line.
3. All Pipe threads need to have proper, gas-rated, outdoor-rated thread sealant. Flare ends do not need or utilize pipe sealant.
4. Your NG Coyote side burner comes with a ½” regulator
 - a) Installer needs to seal the regulator to the hose using pipe sealant.
 - b) Then attach the flare end to manifold line, with no pipe sealant.
 - c) Next, attach connection hose (not included) to the other side of the NG regulator (it is also ½” MIP)
 - i. We suggest using ½” stainless steel corrugated hoses for all NG Side burners
 - ii. Make sure that you purchase a hose of adequate length and capacity for the intended application.
 - d) Connect the other end of this hose to shut-off valve
 - i. Depending on your choice of hose and shut-off, the nipple going into the shut-off valve may vary.
 - e) Test all connections for leaks with a soap and water solution.

Coyote is not responsible for the selection or performance of the contractor or installer who performs the connection of the natural gas supply to the side burner.



Operating the Side Burner

DANGER

- Failure to open the lid prior to igniting the barbecue's burners, or not waiting 5 minutes to allow the gas to clear if the barbecue does not light, may result in an explosive flame-up which can cause serious bodily injury or death.

WARNING

- NEVER use the grill if gas odor is present.
- NEVER stand with head, body, or arms over the grill when lighting.
- ALWAYS inspect the hose before using the grill. If there is excessive abrasion or wear, or if the hose is cut, it must be replaced prior to the outdoor cooking gas appliance being put into operation. The replacement hose assembly shall be that specified by the manufacturer.
- ALWAYS ensure the area around the barbecue is clear of flammable substances such as gasoline, yard debris, wood, etc.
- ALWAYS ensure there is no blockage of the airflow through the vent space located below the face of the unit.

GENERAL RULES

WARNING

NEVER leave the side burner unattended while cooking!

- Make sure the side burner has been leak-tested and is properly located, with necessary ventilation and clearances.
- Check that the end of each burner tube is properly located over each valve orifice.
- Light the side burner burners using the instructions provided in this manual.
- Adjust heat settings to your desired cooking temperature.
- Allow side burner to cool down, wipe off any splatters or grease and clean the drip tray.
- NEVER put a cover on the side burner while it is still hot as it could start a fire.

DANGER

Keep any electrical supply cords and the fuel supply hose away from any heated surfaces.

Lighting Instructions for your Side Burner



Using the Side Burners Built-In Ignition System:

1. Open the canopy.
2. Keep your body, arms and face as far away from the burners and cooking surface as possible.
3. Select the burner that you want to ignite. Depress and rotate the knob corresponding to that burner counter-clockwise to the "High" position.
 - a. As you are nearing the "High" position, you will notice the valve getting tougher to turn. This is the spring inside the valve building up energy to create the spark. Once you hear a click, the igniter has fired the spark for that burner.
 - b. Do not turn the knob too fast, as you need the gas to travel into your manifold, then to your valve and finally into the burner where it will meet the spark from the igniter (at the front of the burner). Conversely, if you turn the knob too slowly, you can cause a build-up of gas in the side burner and create a large flash when it ignites.
4. If the burner does not ignite on the first attempt, try again immediately but be very aware of any gas building up inside the side burner.
 - a. **⚠ WARNING ⚠** If the side burner does light after three consecutive attempts, turn the knob to the "Off" position, keep the canopy open, and allow the side burner to clear of any built up gas for at least 5 minutes before starting the process again.
5. If at this point the side burner will still not ignite, contact Coyote Customer Service for further assistance to troubleshoot your side burner.

Using Your Burners and Grilling Safely

Your side burner is designed to reach a temperature that you set by adjusting a valve that in turn adjusts the amount of gas that goes through each burner. This valve is located behind your knob and is the key to your heat and fuel consumption.

Furthermore, the way to ignite the burners is through the valves, so please understand the importance of the valves/knobs and the position/care taken with respect to them.

WARNING

- Example: If you forget to turn a knob off and the burner is not lit, then you will have a gas leak out of that valve. You must be aware of your side burner's status and be responsible!

When you first ignite your side burner, burn the side burner to get rid of any odors or trace debris that may be left over from manufacturing and transit. This is done by operating your side burner at the "HIGH" setting with the hood closed for no more than 5 minutes. After you have "burned off" the side burner, you are ready for cooking!

Preparing Food for the Side Burner

WARNING

Always observe safe food-handling and safe food-preparation practices when using this Side burner, to prevent food-borne illnesses.



- Always cook foods adequately. Undercooked foods can retain bacteria, especially if thawed or exposed to warm conditions prior to cooking.
- Always use separate plates and utensils for the handling of raw food. Never place raw food and cooked food on the same plate, and never place cooked food on a plate that was used for handling raw food.
- Always carefully wash all plates and utensils used to handle raw food before using them to handle cooked food.
- Always wash all vegetables, seafood and poultry before cooking.
- Always leave uncooked foods in the refrigerator until you are ready to start cooking.
- Always marinate meat in the refrigerator. Dispose of the excess marinade, and never reuse it.

Side burnering Tips:

- If you pre-cook meat or poultry, do so immediately before side burnering.
- Refrigerate leftovers within 2 hours of taking food off the side burner.
- Never let the tray boil dry, as that could be hazardous. Grease from fatty foods that have collected in the tray could ignite and possibly cause bodily injury or property damage.
- Use a meat thermometer to be sure food has reached a safe internal temperature.
- Always trim excess fat from your foods to reduce the occurrence of flare-ups during cooking.
- Apply a light coating of cooking oil to the cooking grids before side burnering, to prevent foods from sticking.
- Cook similar portion sizes together, so that they all cook evenly.
- Use tongs to turn foods on the side burner.
- Never pierce foods while they are cooking on the Side burner, as this will dry them out.
- Turn foods infrequently. Some chefs say that a good steak should never be turned more than once.
- Apply sugar-based sauces such as commercial barbecue sauces only during the latter stages of cooking, to prevent charring.
- Soak the string you use to tie up roasts and poultry on the rotisserie spit to protect it from burning.

- Use a disposable aluminum tray filled with water, fruit juice, wine or a marinade to add extra flavor and moisture to slow-cooked foods like roasts, whole chickens, turkeys or ducks.

Controlling Flare-ups

 **WARNING**  Flare-ups are a part of cooking meats on a gas side burner. This adds to the unique flavor of cooking on a gas side burner. Excessive flare-ups resulting from the build-up of grease in the bottom of the side burner can over-cook the food and cause a dangerous situation for you and your side burner. If this should occur, DO NOT pour water onto the flames, which can cause the grease to splatter and could result in serious burns or bodily harm. If grease fire occurs, close the hood and turn off the main burners until the grease burns out. Use caution when opening the hood as sudden flare-ups may occur.

To Minimize Flare-ups:

- Trim excess fat from meats prior to cooking.
- Cook meats with high fat contents (chicken or pork) on Low settings or indirectly.
- Ensure that your side burner is on level ground and the grease is allowed to evacuate the side burner through the drain hole.

Care & Maintenance

CAUTION

All cleaning and maintenance should be done only when grill is cool & with the fuel supply turned off at the cylinder or source.

DRIP TRAY

The drip tray located below the side burner should be cleaned periodically to prevent buildup of debris.

NOTE: Allow the drip tray to cool before attempting to clean.

IMPORTANT: Do not leave the side burner outside during inclement weather unless it is covered (cover sold separately). Rain water can collect inside the side burner, the side burner cart or the drip tray if left uncovered. If the drip tray is not cleaned after use and the side burner is left uncovered, the drip tray will fill with water causing grease and water to spill into the side burner cart. We recommend cleaning and storing the drip tray after every use.

COOKING GRATES

The cooking grates can be cleaned immediately after cooking is completed and after turning off the side burner. But, exercise extreme caution because the grates will be very hot if you clean them immediately after cooking. Wear a barbecue mitt and scrub the cooking grates with a damp cloth. If the side burner is allowed to cool down, cleaning the grates will be easier if removed from the side burner and cleaned with a mild detergent.

BURNERS

IMPORTANT: Gas control knobs should be in the “OFF” position and fuel line/source should be disconnected. To reduce the chance of FLASHBACK, the procedure below should be followed at least once a month or when your side burner has not been used for an extended period of time.

Burners:

1. Remove burners from side burner body by carefully lifting each burner up and away from gas valve orifice. Wire brush entire outer surface of burner to remove food debris and dirt. Clean any clogged ports with a stiff wire such as an open paper clip.
2. Inspect the burner for damage (cracks or holes) and if such damage is found, order and install a new burner.
3. After installation, check to insure that gas valve orifices are correctly placed inside the proper position, also check position of spark electrode.

Stainless Steel Care and Maintenance

It is a common misconception that stainless steel will maintain its original factory shine with little help from the consumer. Unfortunately, this is not true. Stainless steel will not stain, discolor, corrode or rust as fast as other types of steel, but it is not fully stain or weather proof. If it is not properly maintained, all grades of stainless steel can face surface discoloration, corrosion and eventually rust. Any stainless steel that is exposed to the environment will require attention and care throughout its life to ensure that it keeps its shine and structural integrity.

Cleaning the Stainless Steel and Polishing

1. Allow side burner to cool before cleaning/polishing stainless steel. Do not clean or polish your side burner’s stainless steel when the grill is in operation or still hot.
2. To clean the stainless steel, wash off all dirt and debris from the steel with warm water. If you have tough spots to clean, then a third-party degreaser product can be used.
3. Next, rinse and dry the steel thoroughly with a clean towel. Do not allow the steel to air dry as the standing water can cause surface discoloration.
4. The last step is to protect the unit with a good third-party polish. There are several third-party polishes on the market that will help keep your side burner protected from the elements for a longer period of time. Most of these polishes are toxic, so only use these on the exterior of the side burner. Follow instructions provided on any third-party polish products. Do not use such products on cooking grates or flavorizers.
 - a. Apply the polish to a clean paper towel and wipe with the direction of the grain in the stainless steel.
 - b. There should be no excess liquid on the surface but it is acceptable for it to be a little oily, as that will dissipate.
5. If your side burner has developed surface discoloration or surface rust, clean the unit as stated above and use a good third-party polish to remove or reduce the spots. Follow instructions provided on any third-party polish products. Coyote does not insure or guarantee the performance of or results from such products.

Environmental Factors that can affect your Side burner

There are several typical causes for surface discoloration and corrosion on your stainless steel outdoor equipment:

- 1) Mortar (which contains lime) from the island assembly process has rested on the unit for a prolonged period

of time and the unit was not cleaned quickly.

- 2) Pool chemicals were splashed onto the side burner (chlorine and acid will cause problems quickly) and the unit was not cleaned off promptly.
- 3) Hard water from sprinklers (chlorine in the water) was allowed to sit on the unit.
- 4) Salt from the ocean air/water was allowed to rest upon the side burner for a prolonged period of time before being cleaned (beach owners must be diligent in maintaining their outdoor stainless equipment).
- 5) Dust, or rust, from other metals found its way onto the side burner and was left on for an extended period of time.
- 6) Organic matters (such as certain types of food) might have gotten onto the surface of the side burner and it was then covered. With high humidity and low oxygen, corrosion will start to take place.
- 7) Sprays and cleaning solutions containing alkaline, lime, acid, salt, etc. might have been left on the side burner surface un-dried.
- 8) Failure to clean or polish your side burner in accordance with the instructions above

Ways to Avoid Rust on your Side burner:

- 1) Purchase a Coyote Side burner cover for your unit. This will ensure that your cover is a correct fit and breathable, while providing the protection needed to keep contaminants off of the surface.
- 2) When installing the unit, make sure to keep the unit covered when any masonry work is being performed. If any mortar or dust does come into contact with the stainless, make sure to wipe it off as soon as possible and use a stainless steel polish immediately afterward.
- 3) Position your side burner away from areas that can receive water splash from a pool or hot tub.
- 4) Do not store pool chemicals in your island or island cabinets.

How to Remove Scratches from your Stainless Steel:

If your situation is a little more serious and you have obtained scratches in your equipment, then you will need to purchase a third-party stainless steel scratch kit. These kits are popular in retail stores but can be easier to obtain online. With these kits, you will not polish the unit until you are done re-scratching the entire product you are working on. With a scratch kit, the goal is to literally re-scratch the entire surface, so that the original grains are replaced by your new scratched-in grains. With this practice, you must be willing to treat the entire surface or you will notice a start and stop point. Also, be careful to pay attention to your rolled or finished edges as these scratch kits will ruin this finish. After you have used the kit, you will want to follow it up with a good stainless polish (as mentioned prior) and then a dry towel for a final wipe down. Follow all directions on any third-party stainless steel scratch kits. Coyote does not insure or guarantee the performance of or results from such products.

ANNUAL CLEANING OF BURNER HOUSING

Burn-off the barbeque after every cookout will keep it ready for instant use, however, once a year you should give the entire side burner a thorough cleaning to keep it in top operating condition.

1. Shut off gas supply at source and disconnects fuel line. Protect fuel line fitting.
2. Remove and clean the cooking grids and burners.
3. Cover the gas valve orifices with a piece of aluminum foil.
4. Brush the inside and bottom of the side burner with a stiff wire brush, and wash down with a mild soap and warm water solution. Wash thoroughly and let dry.
5. Remove aluminum foil from orifices and check orifices for obstruction.

6. Check electrode.
7. Reinstall cooking grids.
8. Reconnect to gas source and observe burner flame for correct operation.

IMPORTANT: You should NOT line the bottom of the burner housing with aluminum foil, sand or any other grease absorbent substance, a grease fire may occur.

MAINTENANCE GUIDELINES

1. Keep outdoor cooking gas appliance area clear and free from combustible materials, gasoline and other flammable vapors and liquids.
2. Do not obstruct the flow of combustion and ventilation air.
3. Keep the ventilation opening(s) of the cylinder enclosure free and clear from debris.
4. Visually check burner flames. Burner flames should be blue and stable with no yellow tips, excessive noise, or lifting. If any of these conditions exist call our customer service line.
5. Clean outdoor cooking gas appliance, including special surfaces, with recommended cleaning agents, if necessary.
6. Check and clean burner for insects and insect nests. A clogged tube can lead to a fire beneath the side burner.

Troubleshooting Your Side Burner

GENERAL TROUBLESHOOTING

Inspect your burners at least once a year or immediately if any of the following conditions occur:

- The smell of gas.
- Flames appearing mostly yellow.
- The side burner will not get hot enough.
- Burners make a snapping noise.
- The side burner heats unevenly.



SPIDER AND INSECT WARNING: Spiders and insects can nest in the burners of this and other grills, which could disrupt gas flow. This dangerous condition could cause a fire behind and beneath the valve panel, damaging the grill and making it unsafe to operate. We recommend you check the grill and remove any spiders, insects and webs at least once a year to reduce this risk.

WHEN TO LOOK FOR SPIDERS/INSECTS

You should inspect the burners once a year or immediately after any of the following conditions occur:

1. The smell of gas in conjunction with the burner flames appearing yellow.
2. The side burner does not reach temperature.
3. The side burner heats unevenly.
4. The burners make popping noises.

TROUBLESHOOTING

If the side burner does not function properly, use the chart below to assist in diagnosing the problem.

Troubleshooting is for general purposes only. ALWAYS ERR ON THE SIDE OF SAFETY. If the problem still exists, contact our Coyote Customer Service line at 855-520-1559.

Problem:	Possible Causes and Solutions:
Burner will not light when the igniter button is turned.	<ul style="list-style-type: none">• Is your gas supply turned on?• If this is an L.P. side burner, is there gas in your tank? Check your gas level.• Is one of your burners turned on? Allow up to 5 seconds of gas flow to ignite.• Is your igniter working?<ul style="list-style-type: none">- You should hear a snapping sound when you press the igniter.- If you hear a snapping sound, can you see a spark at the electrodes? <p>Note: You will need to remove your cooking grates and flavorizers to see the electrodes. The electrodes should have a 1/8" to 1/4" gap</p>

	<p>between the electrode and contact point.</p> <ul style="list-style-type: none"> • Check for loose wire connections to the igniter or electrodes. • Check to see if debris is blocking the electrodes. • If the igniter is not working, can you light the side burner with a lighter?
Flare-ups	<ul style="list-style-type: none"> • Ensure burner is not placed directly in the path of wind. Be sure drip pan is clean (do not use aluminum foil on drip pan.) <p>Note: Some flare-ups may be inevitable if cooking greasy foods.</p>
Yellow Flames	<ul style="list-style-type: none"> • Check the burner inlet for obstructions, particularly at air inlets for each burner. • Side burner should not be in an area that is too windy.
Flame blows out on low setting or has uneven heat distribution.	<ul style="list-style-type: none"> • Check for spider webs or insect nest in venturi and clean venturi. • Cold side burner needs to be preheated for 5 minutes on high setting. • Venturi may be misaligned and needs to be lined up over orifices. • Cold and windy weather will require you to move side burner away from the wind. • Lack of fuel. Check to see cylinder valve is open and cylinder has fuel.
Low heat with the knob on "HIGH"	<ul style="list-style-type: none"> • Check to see if the fuel hose is bent or kinked • Make sure the cooking area is clear of dust • Check your gas supply and gas pressure. • If it is only one burner that appears low, make sure the orifice or burner is clean.
Burner is Too Hot	<ul style="list-style-type: none"> • Excess grease build-up causing grease fires. • Damaged or faulty regulator. Replace with factory authorized parts. • Cook on a lower temperature setting.
Flame behind control panel or control knob area.	<p>IMMEDIATELY shut off cylinder valve and allow side burner to cool.</p> <ul style="list-style-type: none"> • Check for spider webs or insect nest in venturi and clean venturi. • Gas is leaking from a faulty connection. Tighten connections with an adjustable wrench and replace damaged parts. Perform a leak test on all connections before cooking on side burner again. • Venturi may be misaligned and needs to be lined up over orifice.
Fire at any connection.	<p>IMMEDIATELY shut off cylinder valve and allow side burner to cool.</p> <ul style="list-style-type: none"> • Gas is leaking from a faulty connection. Tighten connections with an adjustable wrench and replace damaged parts. • Perform a leak test on all connections before cooking on the side burner again.

C1PB Parts List

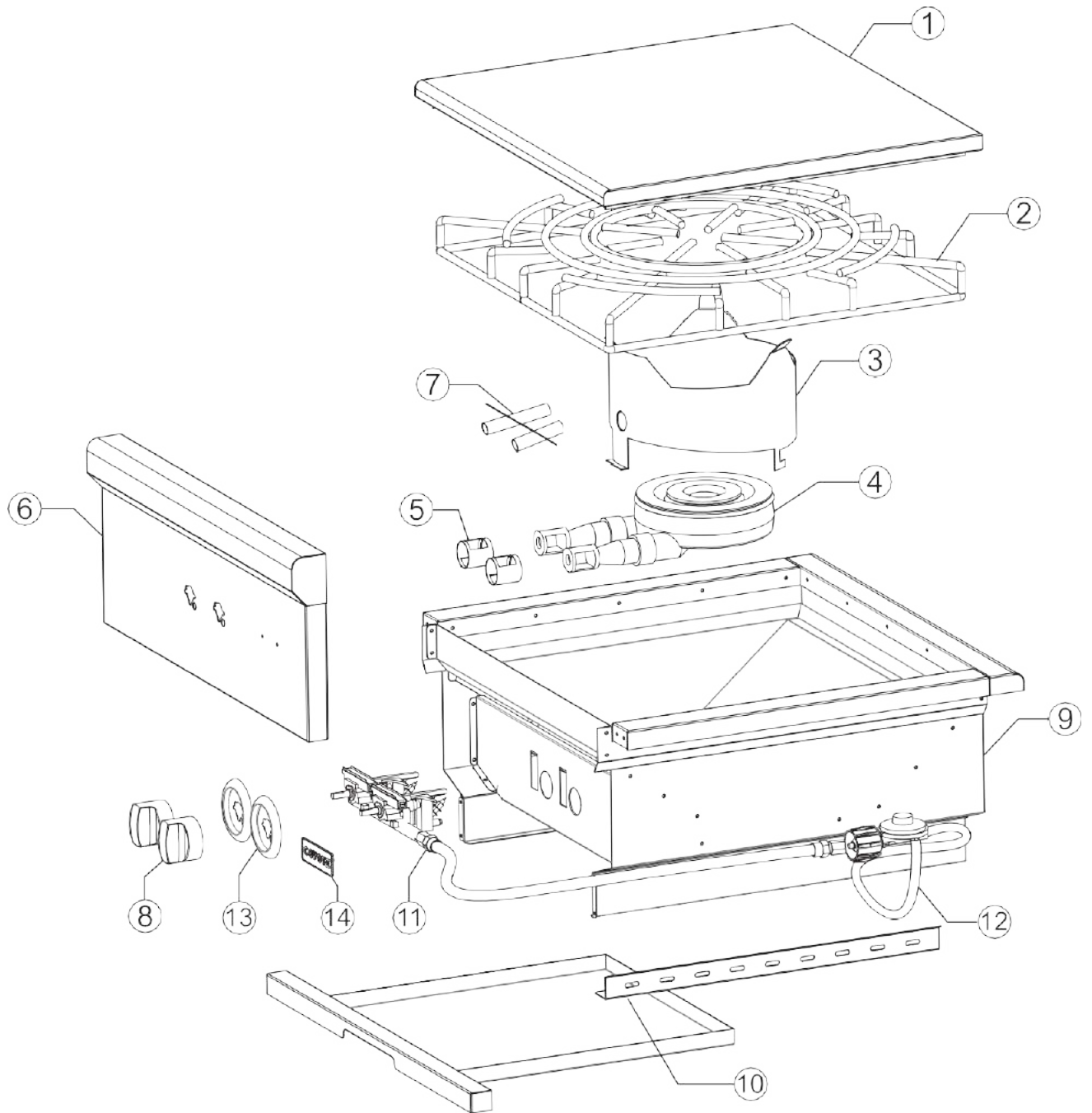

Picture #	Description	Part Number
1	COVER	C1PB-001
2	GRID, STAINLESS STEEL ROD	C1PB-002
3	FLAME COLLIMATOR	C1PB-003
4	BURNER, STAINLESS STEEL	C1PB-004
5	AIR SHUTTER	C1PB-005
6	CONTROL PANEL	C1PB-006
7	FIRE TUBE	C1PB-007
8	CONTROL KNOB	C1PB-008
9	FIRE BOX	C1PB-009
10	DRIP TRAY ASSEMBLY	C1PB-010
11	VALVE MANIFOLD	C1PB-011
12	REGULATOR	C1PB-012
13	KNOB BASE	C1PB-013
14	BREASTPLATE	C1PB-014