

AUTOMATIC VISION PICK AND PLACE MACHINE



**Avoid Getting
Out of Step**



**Positioning
Accuracy**



**Correction
Offset**



**Fast
Placement**



Easy to Use

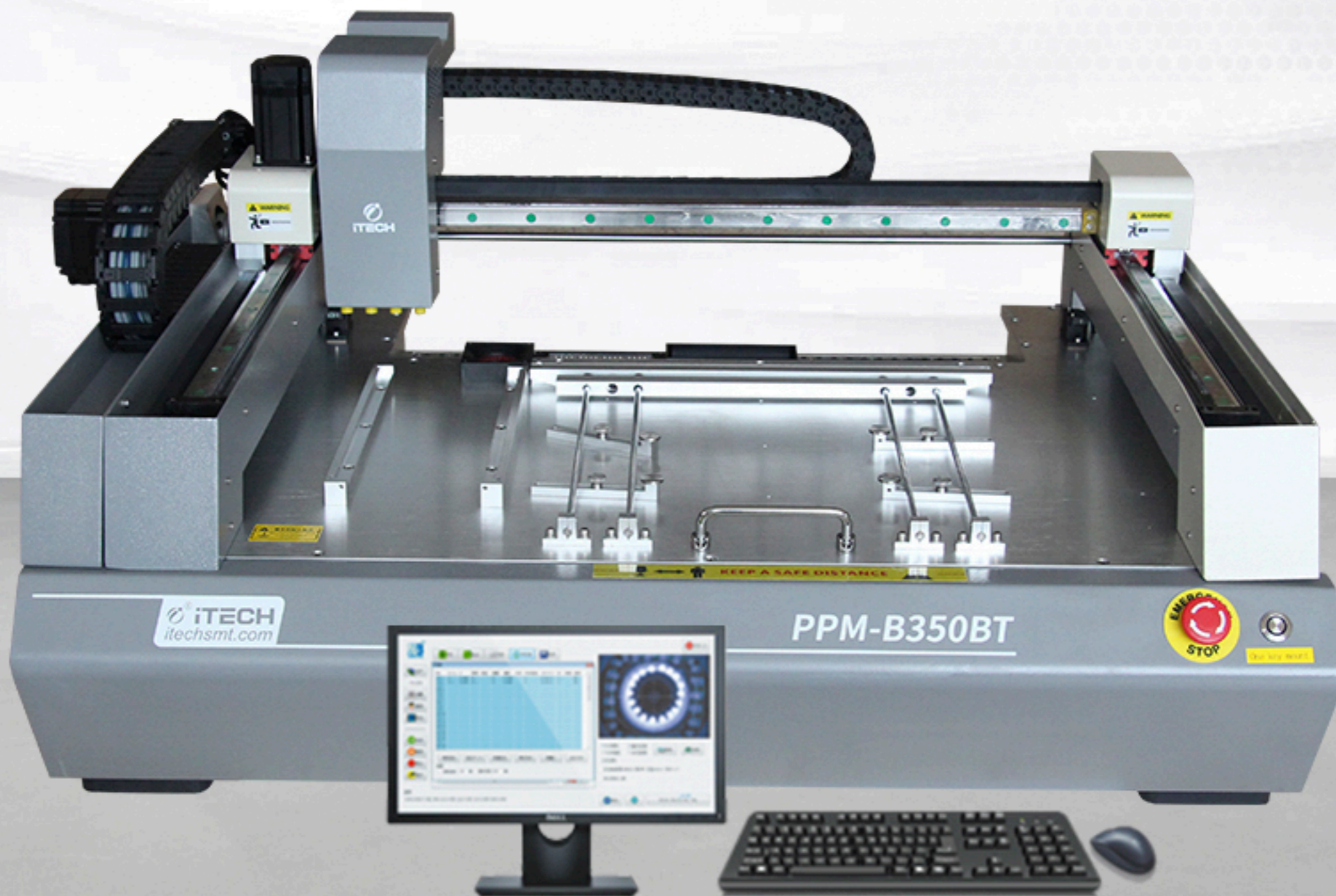

PPM-B350BT

SMT AUTOMATION

PPM-B350BT mounter is suitable for high-precision mounting of conventional resistance capacitance, LED lamp beads, IC, BGA and other components, and is suitable for R&D design, experimental teaching and batch production.

8 CORE TECHNOLOGIES

- | MARK Point Identification and Positioning
- | Support Source File Conversion File
- | Online Editing | Feed Processing
- | Imposition Array | CCD Industrial Camera
- | MARK Point-By-Board Identification
- | PCB Process Difference Compensation

*Please contact us for availability.

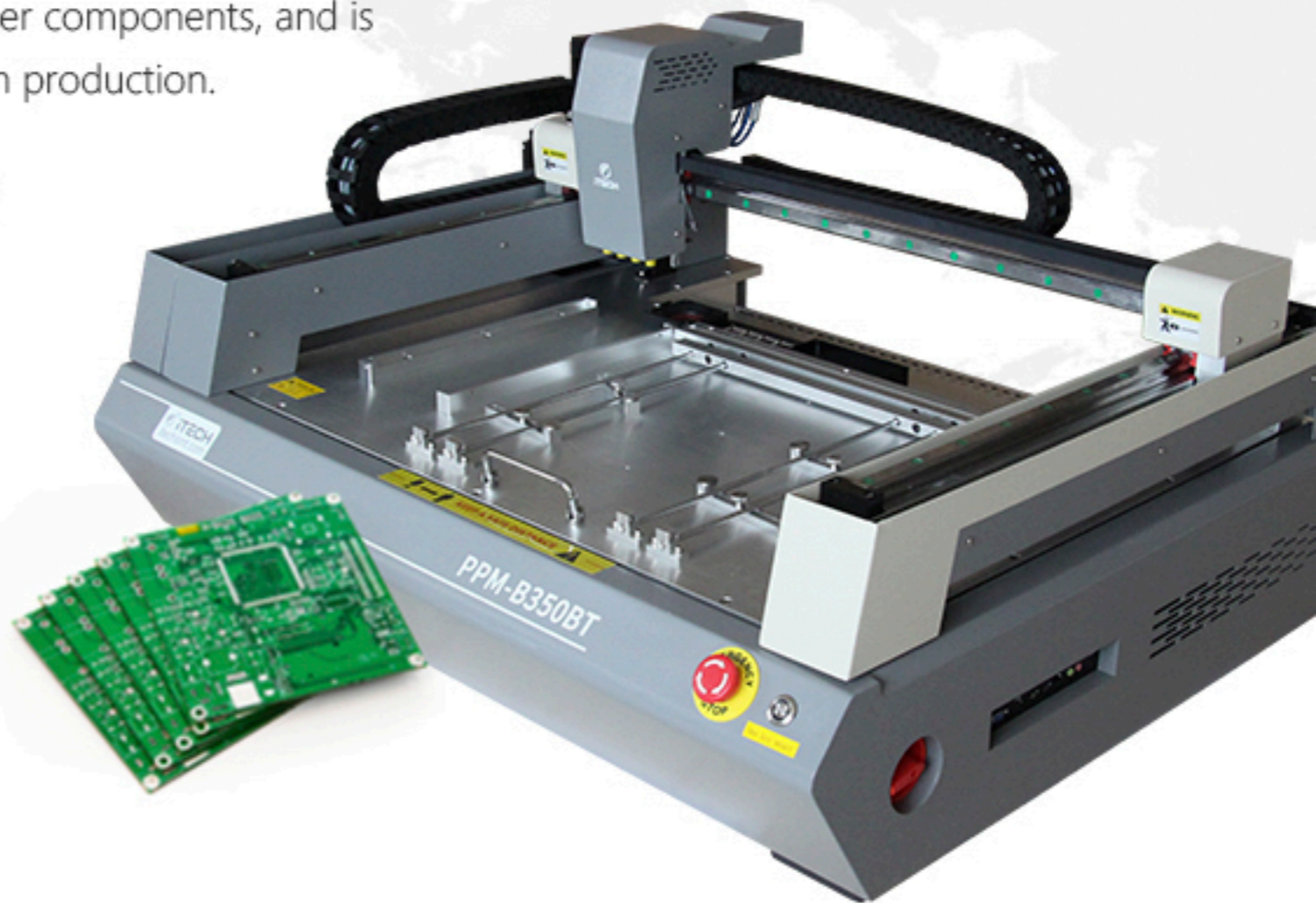

PRODUCT STRUCTURE

ZHEJIANG HUAQI ZHENGBANG AUTOMATION TECHNOLOGY CO., LTD.

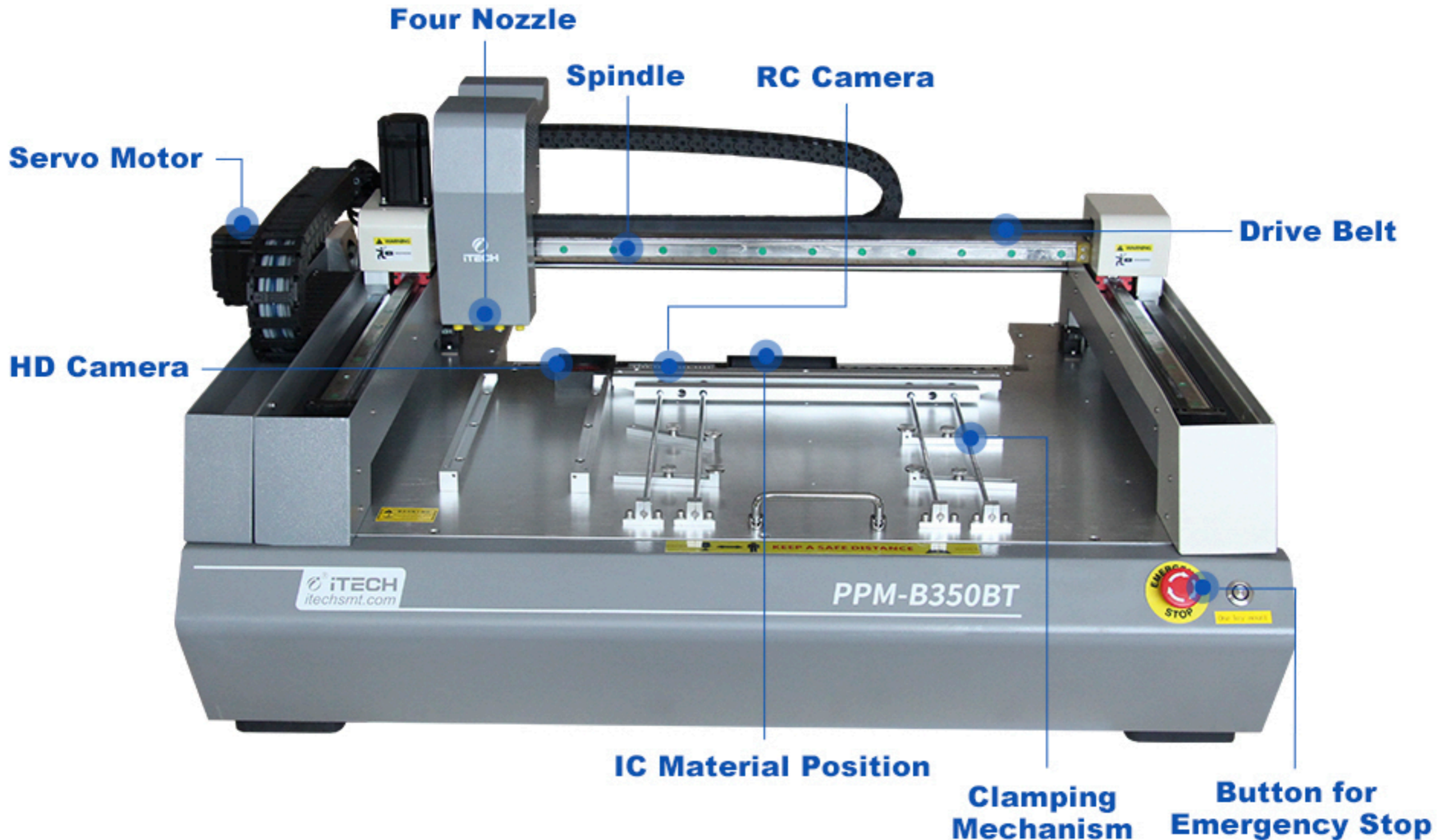

Servo Motor



RC Camera



Clamping Mechanism

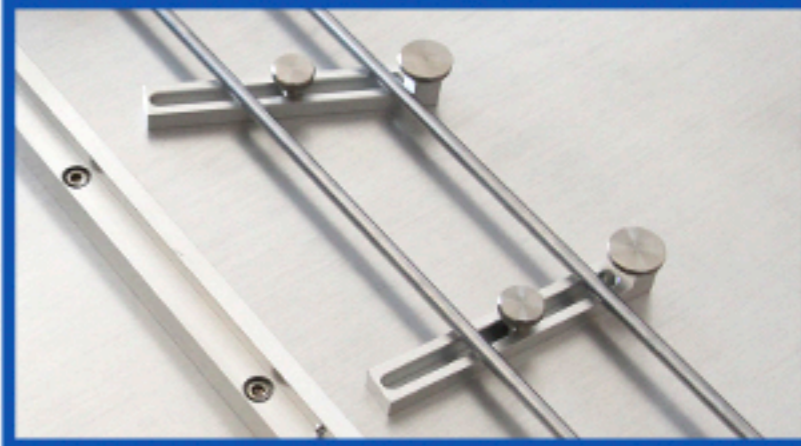

Spindle



Four Nozzle

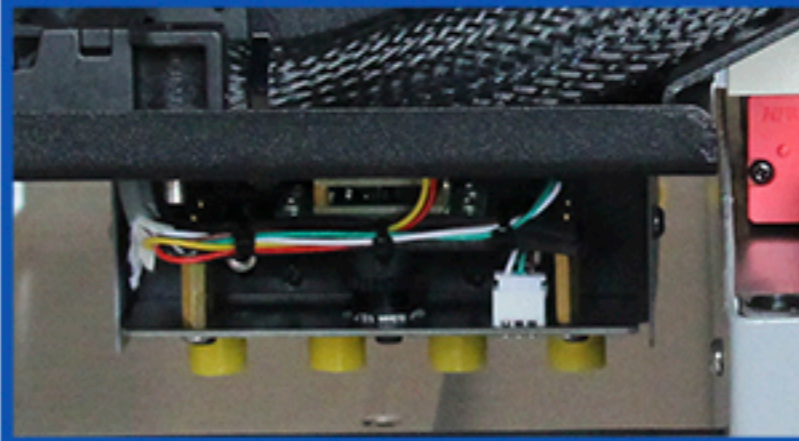

HD Camera

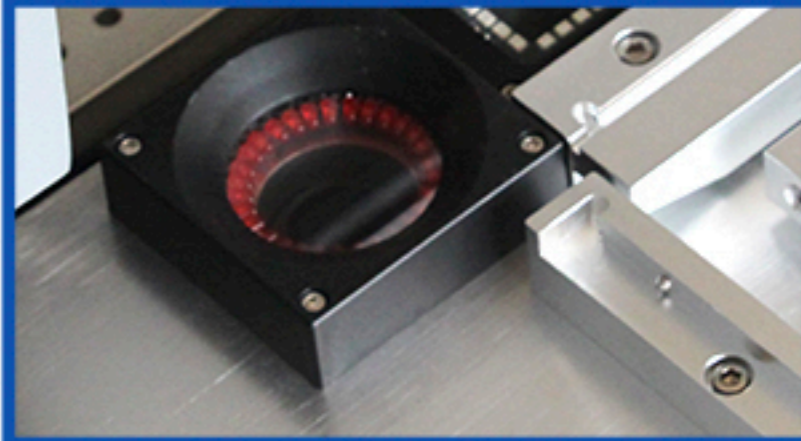

Technical Data

System	Project	Content
Mounting System	Model	PPM-B350BT
	Mounting Numbers	4 PCS
	Mounting Precision	0.025 mm
	Mounding Angle	0 ~ 360°
	Theoretical Speed	7500 PCS/h
	Normal Mounting	6000 PCS/h
	Visual Mounting	5000 PCS/h
	Suction Nozzle Type	Juki Series Nozzle
	Applicable Element	RC (0402, 0603, 0805, 1206 etc)
		LED Lamp Beads (0603, 0805, 3014, 5050 etc)
Chip (SOT, SOP, QFN, BGA etc)		
PCB	PCB Minimal Size	<5.5 mm
	PCB Maximum Size	10×10 mm
	PCB Thickness	350×450 mm
	PCB Warping Allowable Value	≤2 mm
Feeder Tank	Type	YAMAHA CL Materials Feeder
	Feeder	8mm 12mm 16mm 24mm 32mm
	Numbers	38 level
	Tubular Materials Feeder	YAMAHA YV materials feeder
	IC Tray	Postposition 1 PC Tray
X/Y/Z Axis	X/Y Axis Moving Range	655×575 mm
	Z Axis Moving Range	12 mm
Visual System	A Visual Camera	CCD High-Definition Camera
	Numbers of Visual	6PCS(parts camera, PCB camera, High Speed Identification*4)
	Recognition Capability	MAX.22*22mm
Control System	PC System	MicrosoftWIN7
	Operational Software	Researching and Development Independently
	Compatible File Format	CSV、TXT.format
	Program Method	Support online and offline ways
Basic Parameter	Air Pressure	0.8 Mpa
	Vacuum Mode	Vacuum Generator
	Air Pressure	-80 kpa
	Power	500W
	Power Supply	AC220V±10% 50Hz
	Outline Size	L 1185× W 840 × H 560 mm
	Net Weight	123kg

PRODUCT ADVANTAGES

ZHEJIANG HUAQI ZHENGBANG AUTOMATION TECHNOLOGY CO., LTD.



CONFIGURATION STEP SERVO MOTOR

Making the position, speed and moment of force closed cycle control and solve the stepper servo motor out of step problems. Eventually achieved High precision positioning and smooth low speed operation requirements.

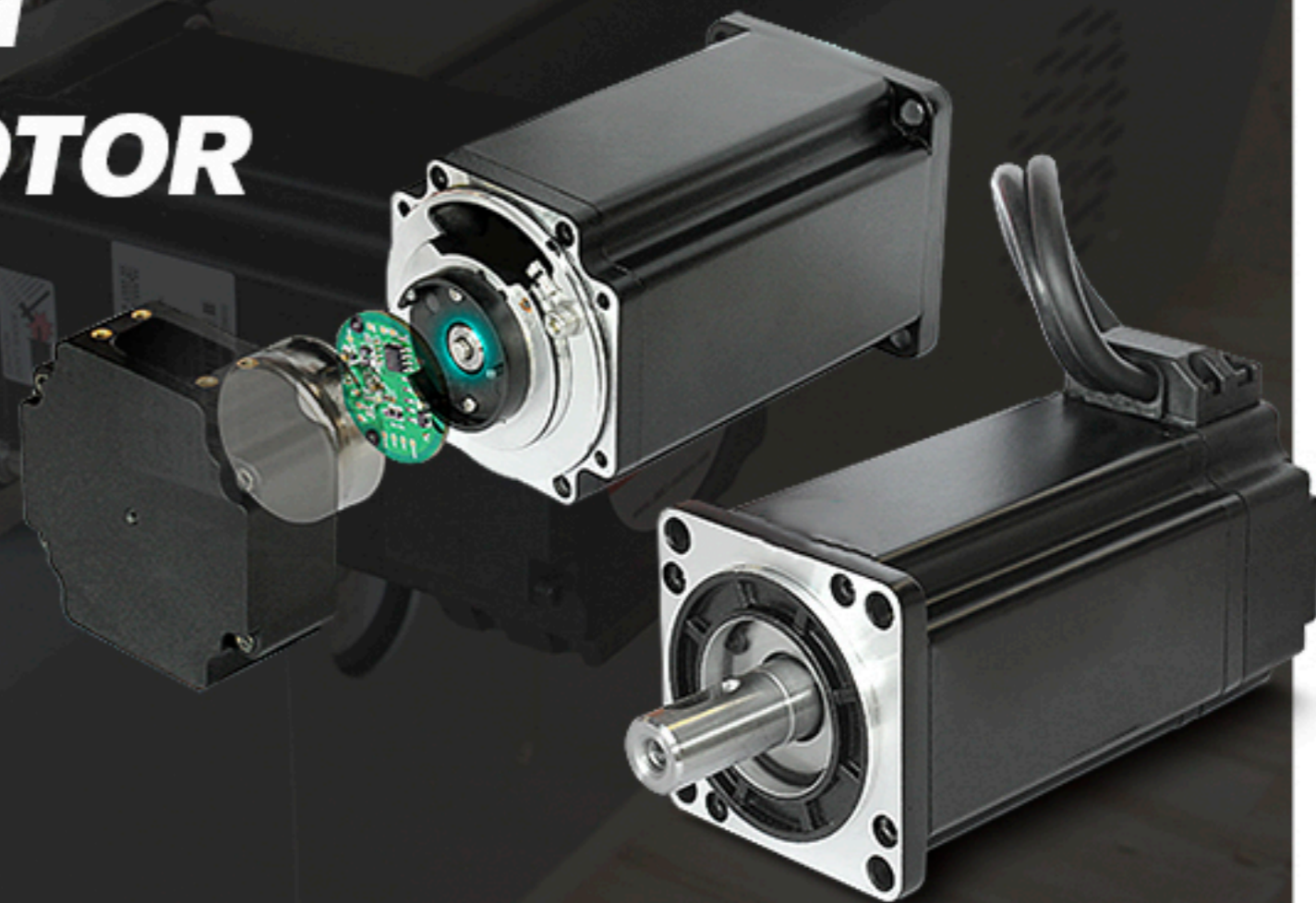

FOUR HEAD MOUNTING

FOUR MARK POINT RECOGNITION

Four head design realizes rapid placement of tiny components and integrated IC components



38 PCS FEEDER

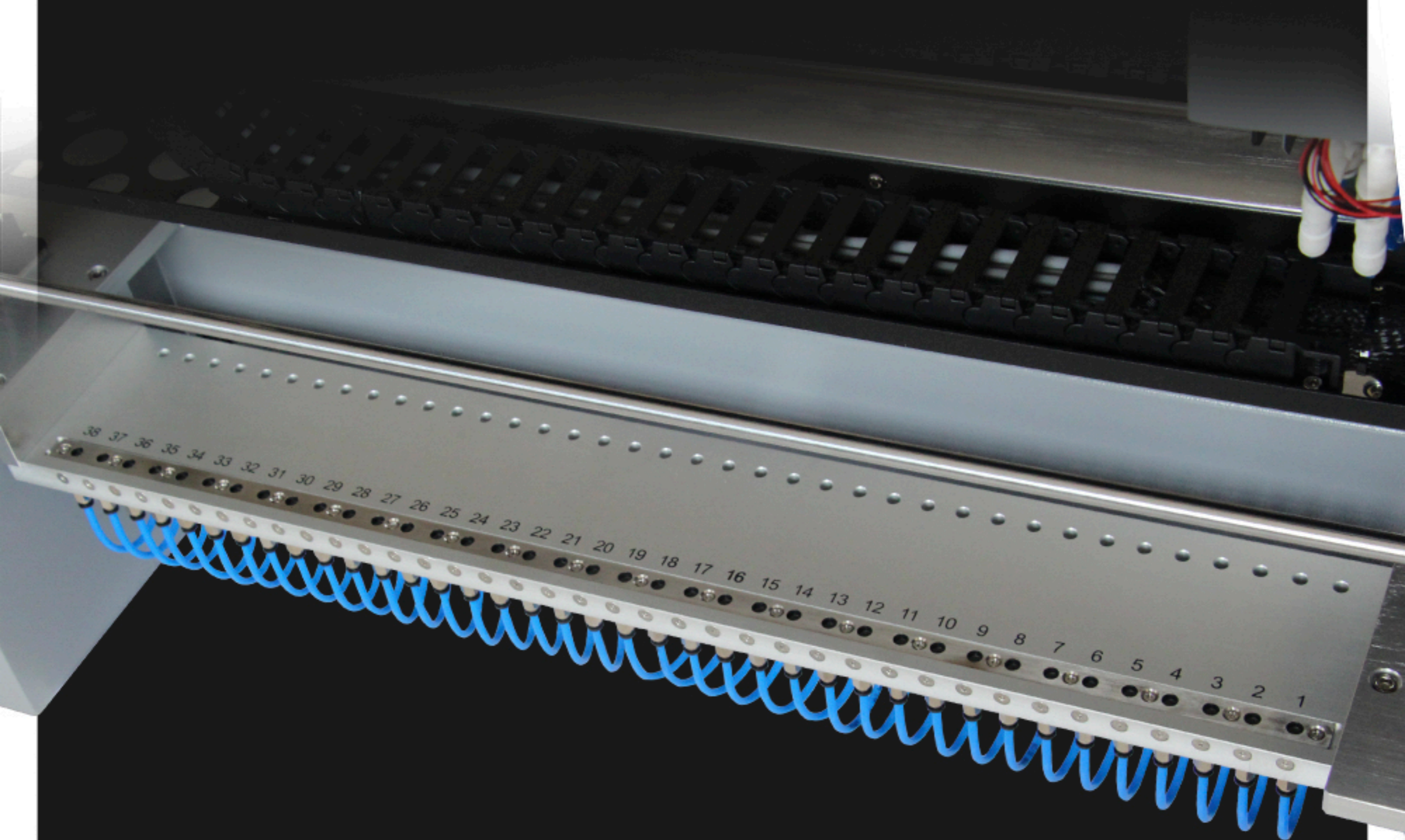

SUPPORT MULTIPLE FEEDERS

Support 38 bit automatic stripping film feeder , TUBE vibration feeder IC tray .Meet diverse needs



IC Tray

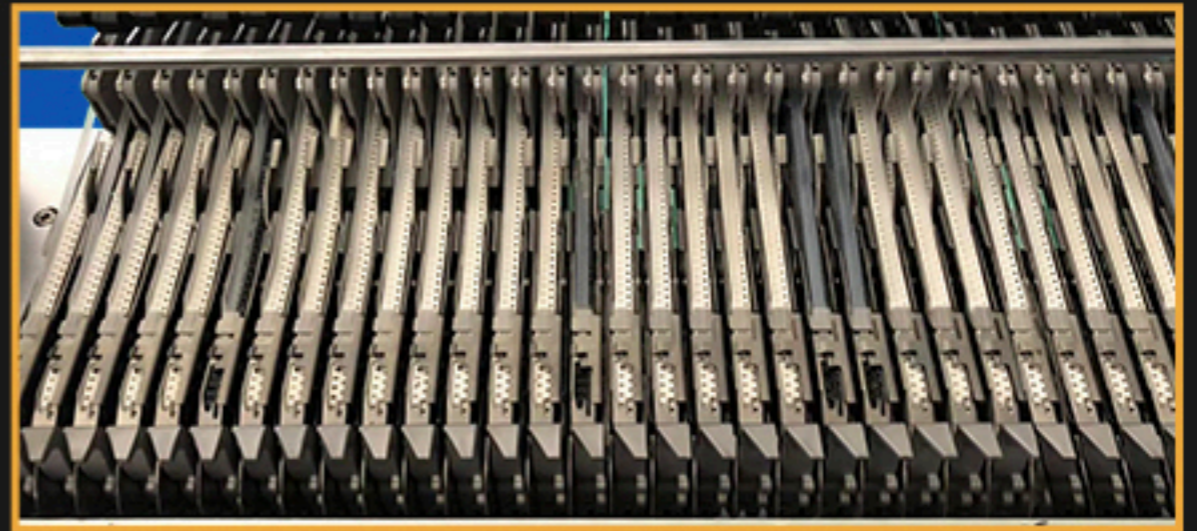

38 bit Yamaha feeder

PCB PLACEMENT

Support Up To 350*450mm PCB Suitable for most circuit board mounting

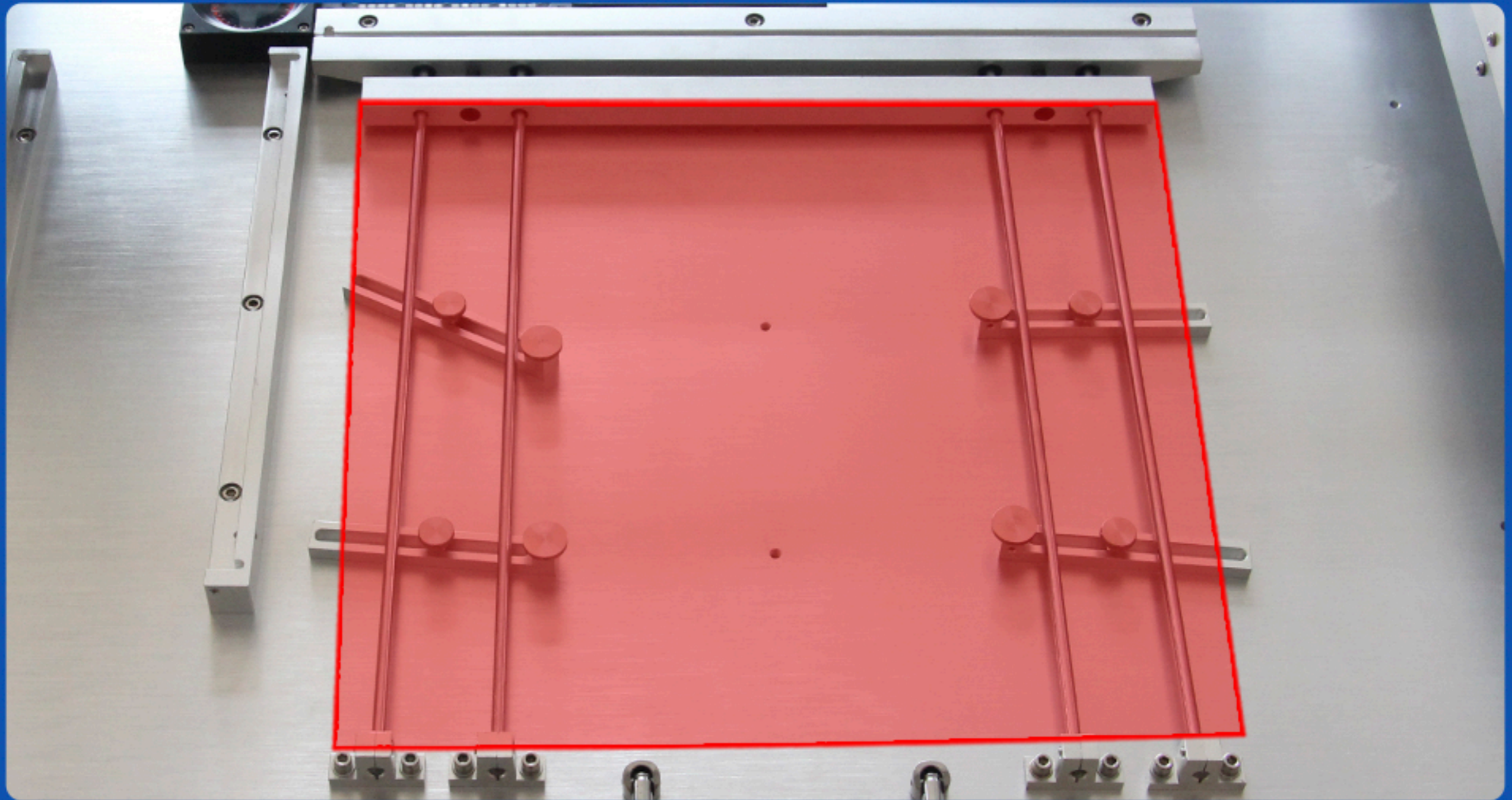

FIVE GROUPS OF IDENTIFICATION CAMERAS

Camera classification and identification are adopted for different packaged chips

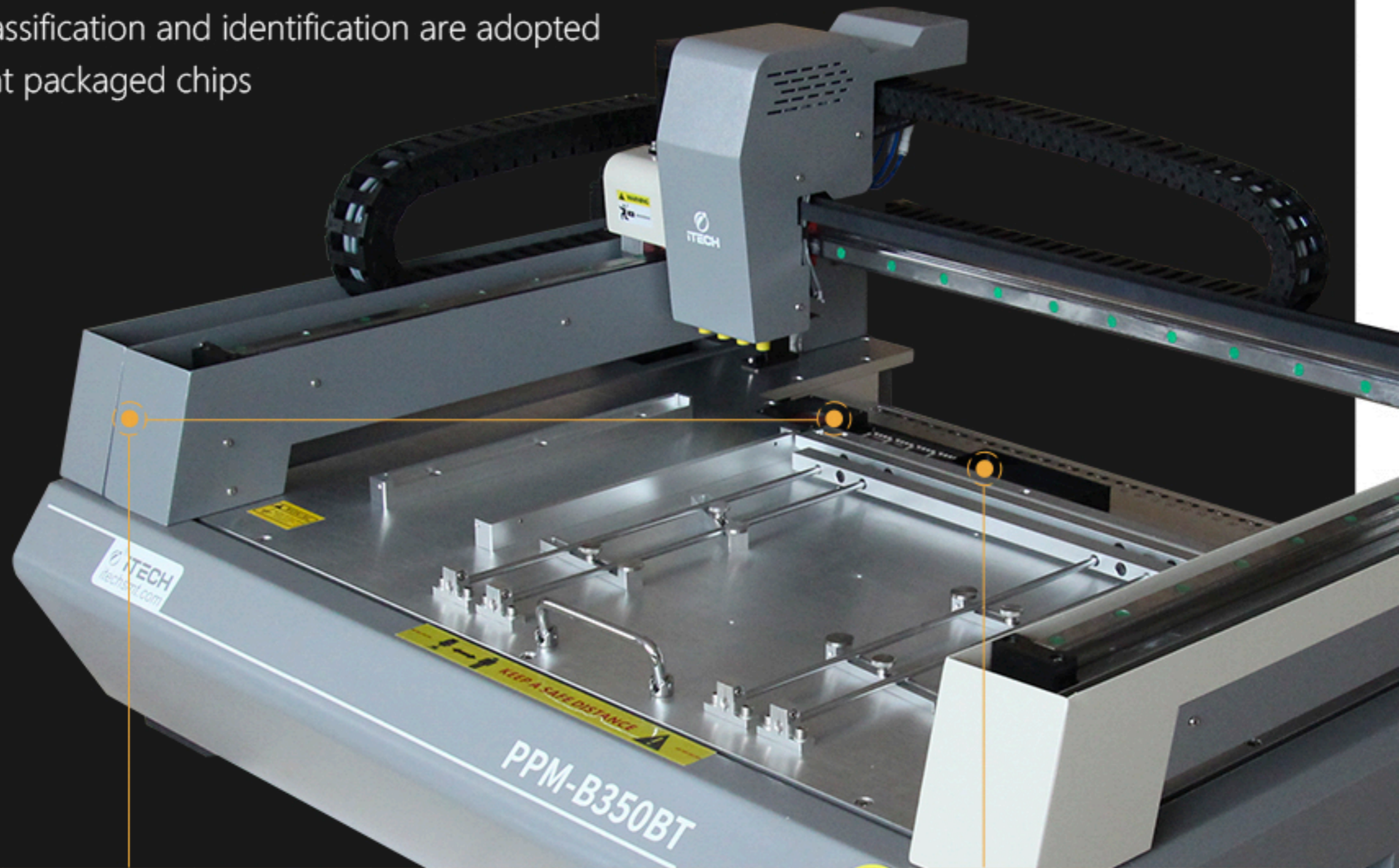

High Precision Identification Camera

High precision identification camera to improve large IC identification and placement accuracy Correction the material offset .



Four Components Identification Camera

The fast Four camera recognition system is adopted for different package chips to improve the efficiency of resistance and capacitance chip recognition

OPTIMIZE INTERFACE EDITING INTERFACE

More User-friendly Control System Easy to Learn, Understand and Operate 1 Hour to Get Started, 3 Days to Skilled, 7 Days to Master

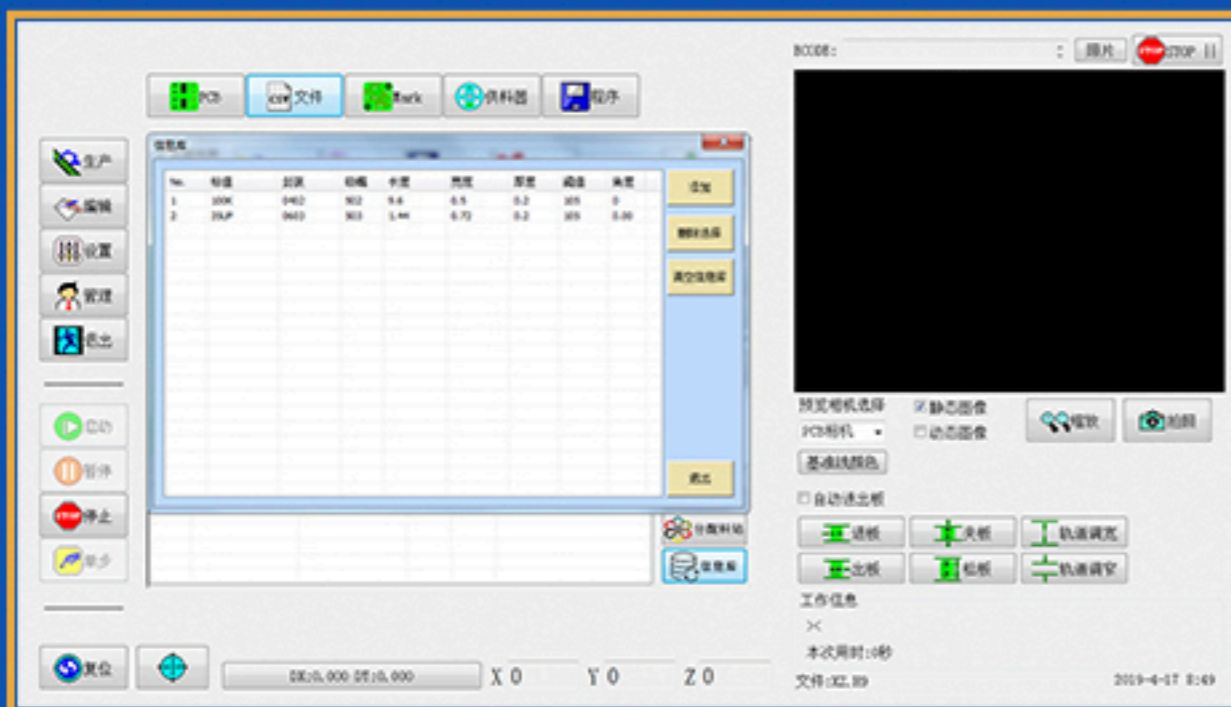
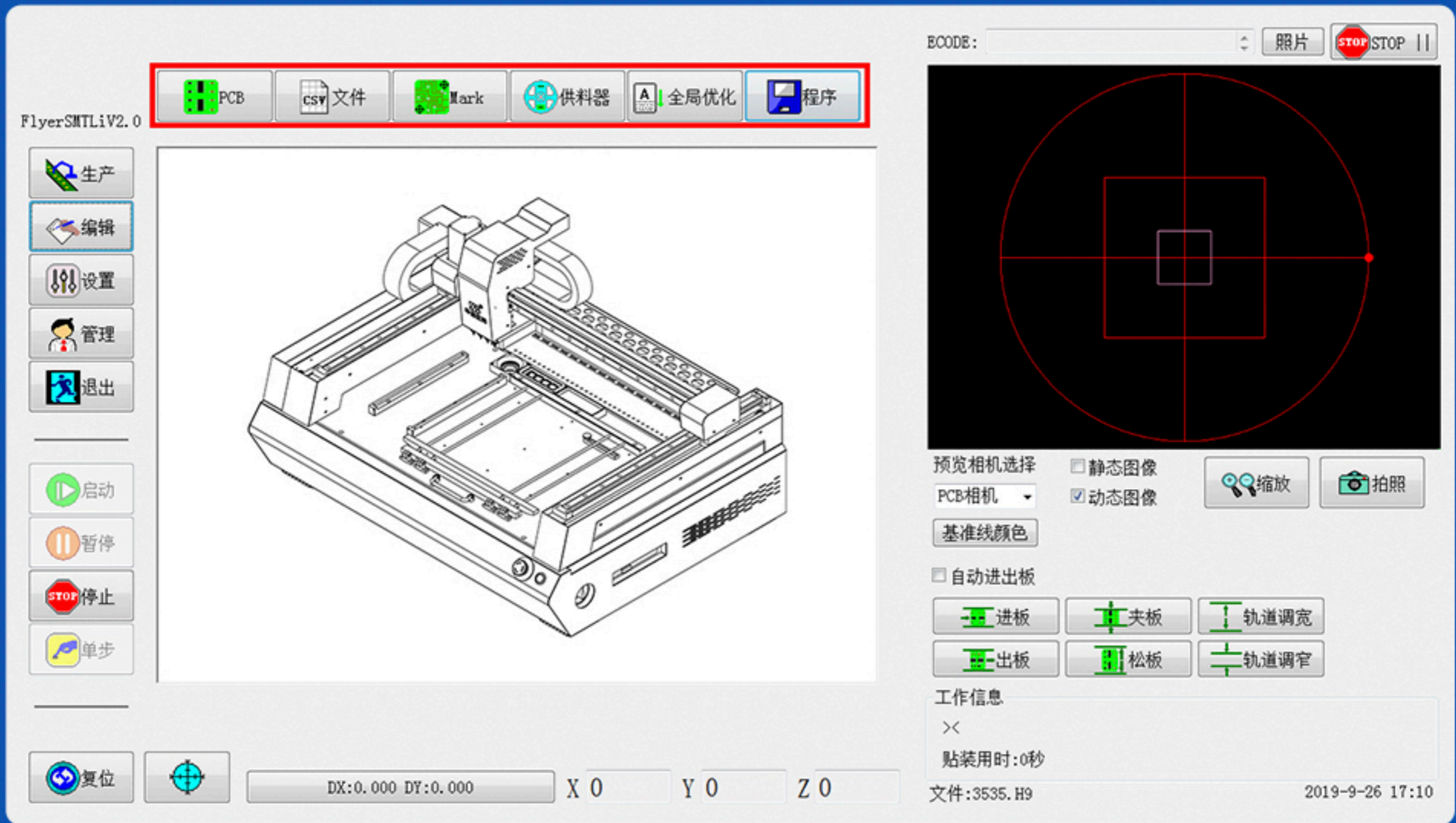

DATABASE FUNCTION

The component package that has been automatically stored and edited does not need to be edited repeatedly

DOUBLE MARK POINT IDENTIFICATION BIT

The dual Mark identification and positioning function automatically corrects the offset caused by the irregularity of the PCB and the incorrect position

EMBEDDED INDUSTRIAL PC AND WINDOWS SYSTEM



Windows system, simple and convenient operation, performance much more stable



Embedded industrial PC, quality much more stable and reliable

EFFECT PICTURE

Maximum 6000pcs/h mounting Achieve high speed mounting requirements

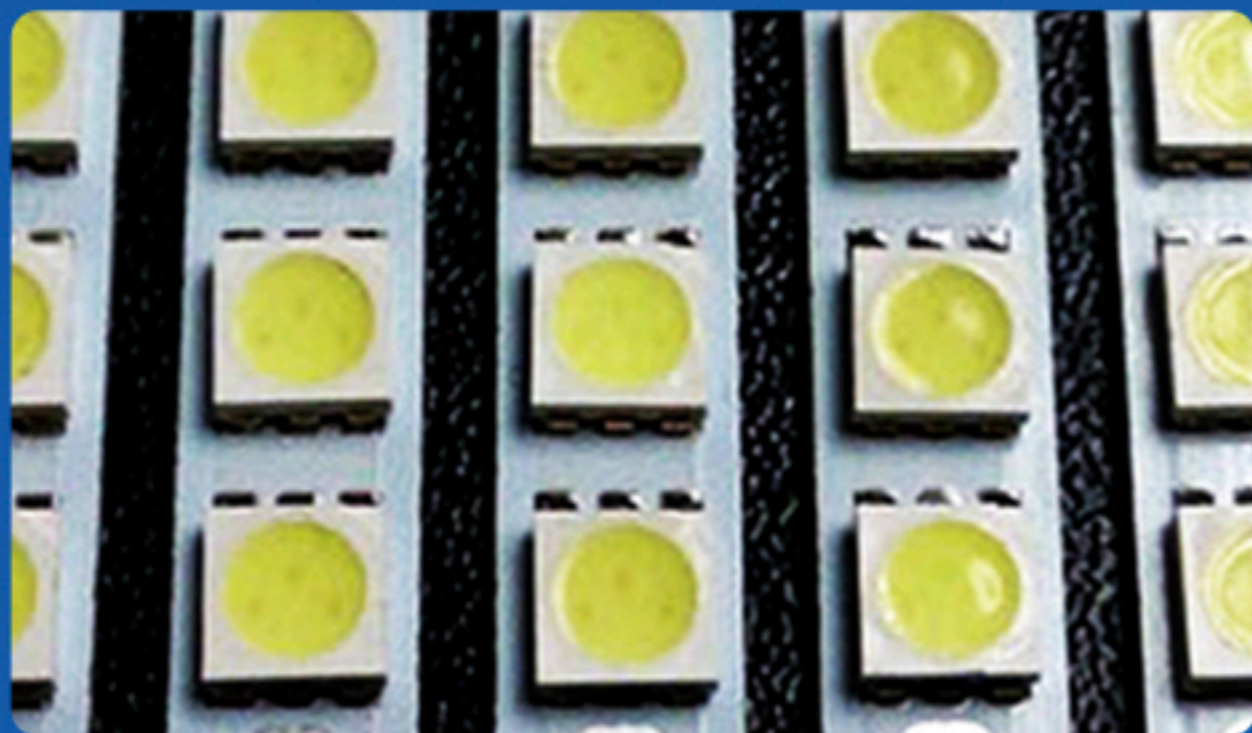

All Kinds of LED Mounting

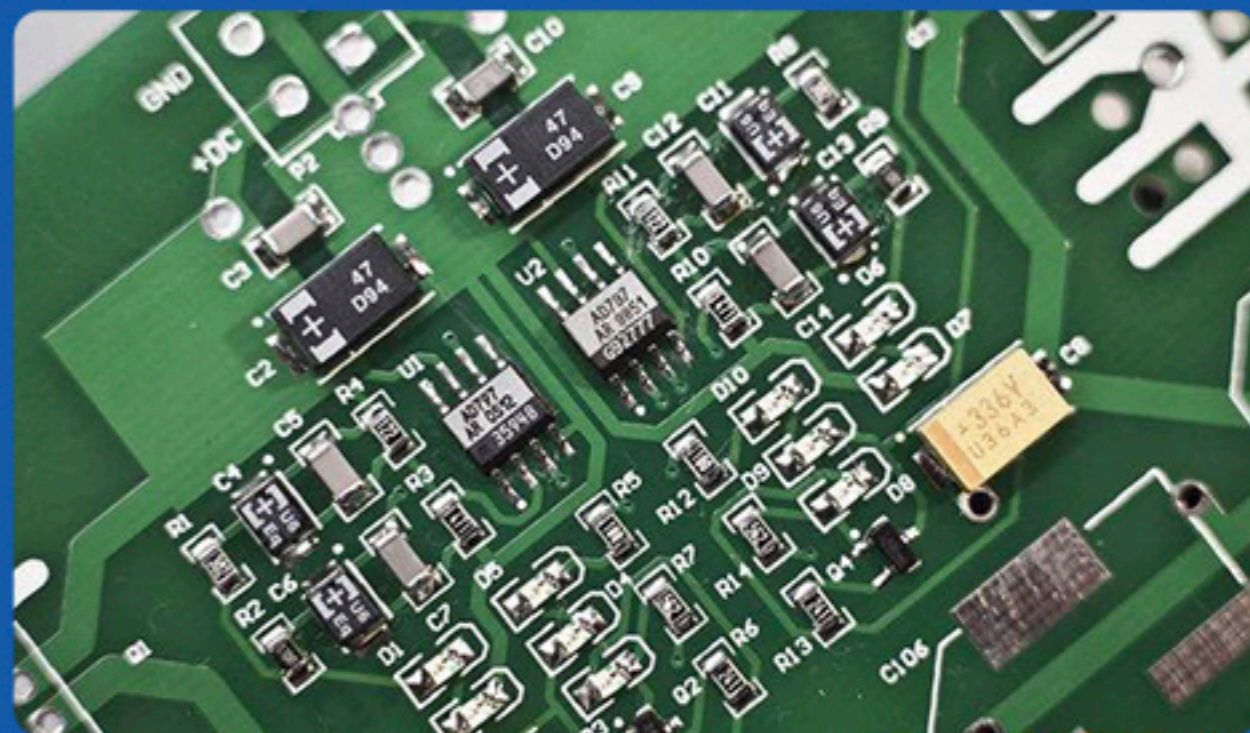

Resistance,Capacitance ,Triode and IC Mixed Mounting

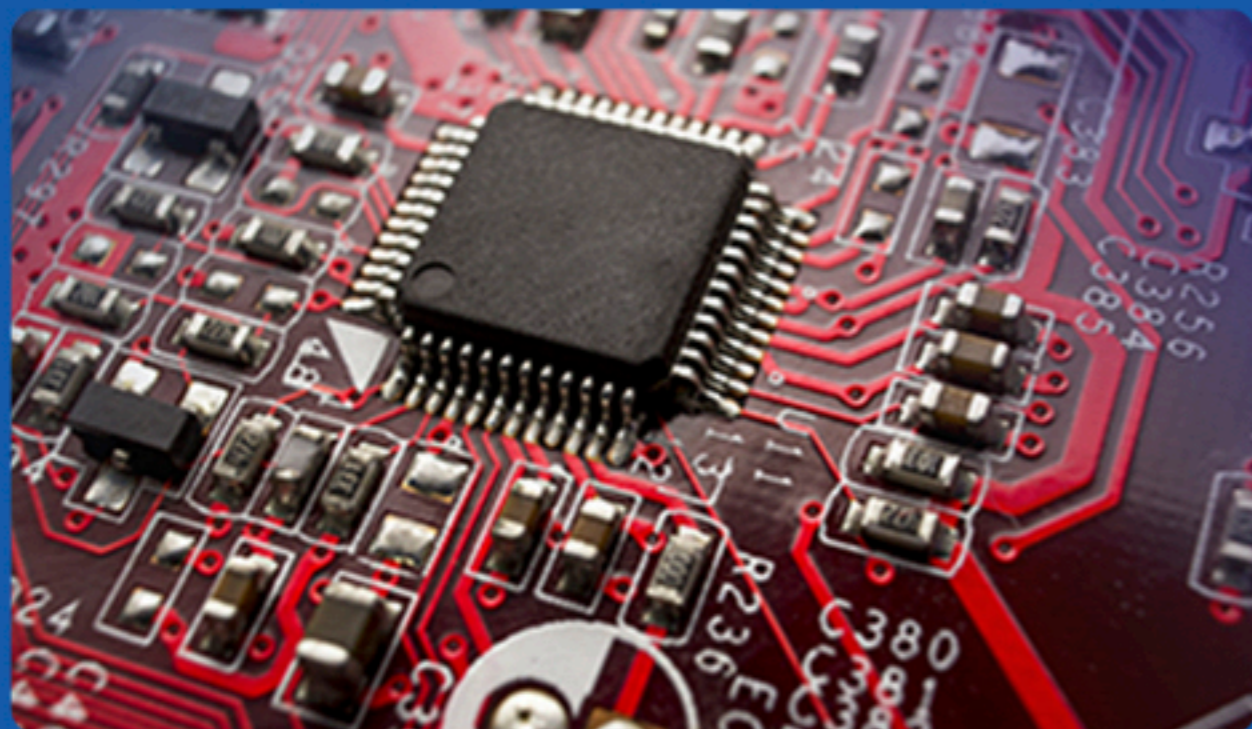

Resistance,Capacitance and IC Mixed Mounting

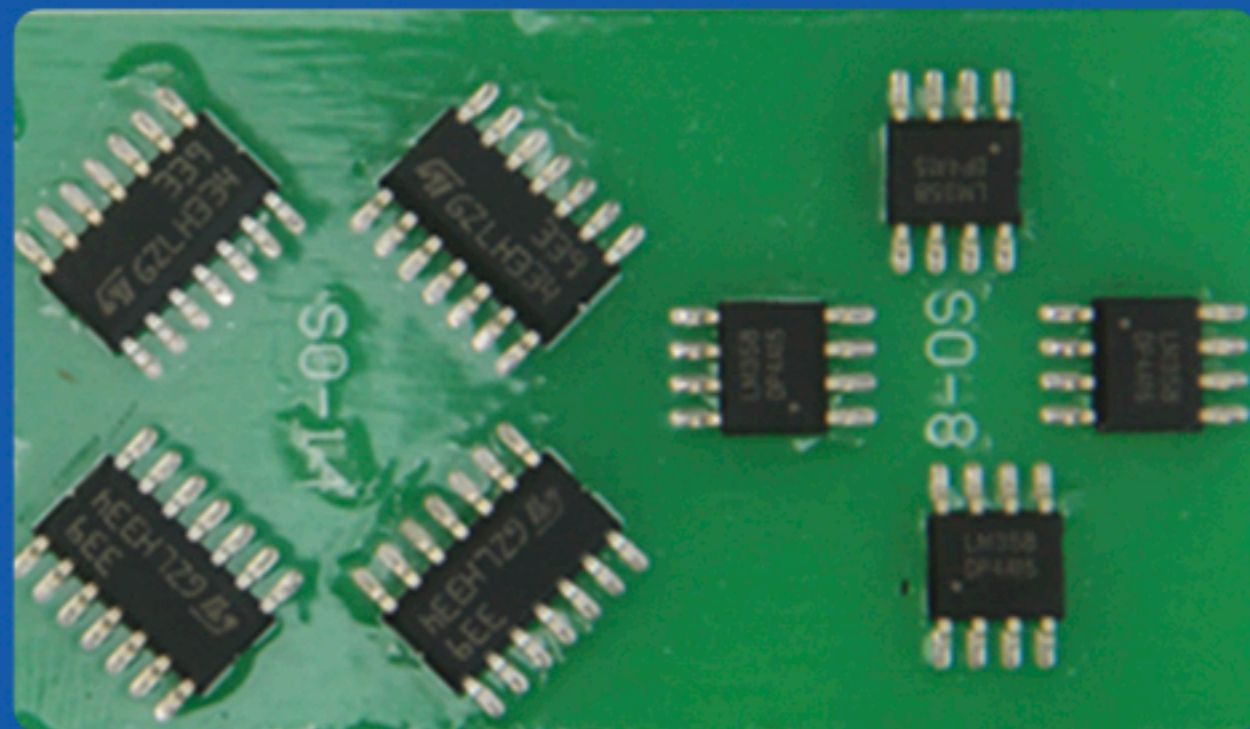

IC Each Angel Mounting

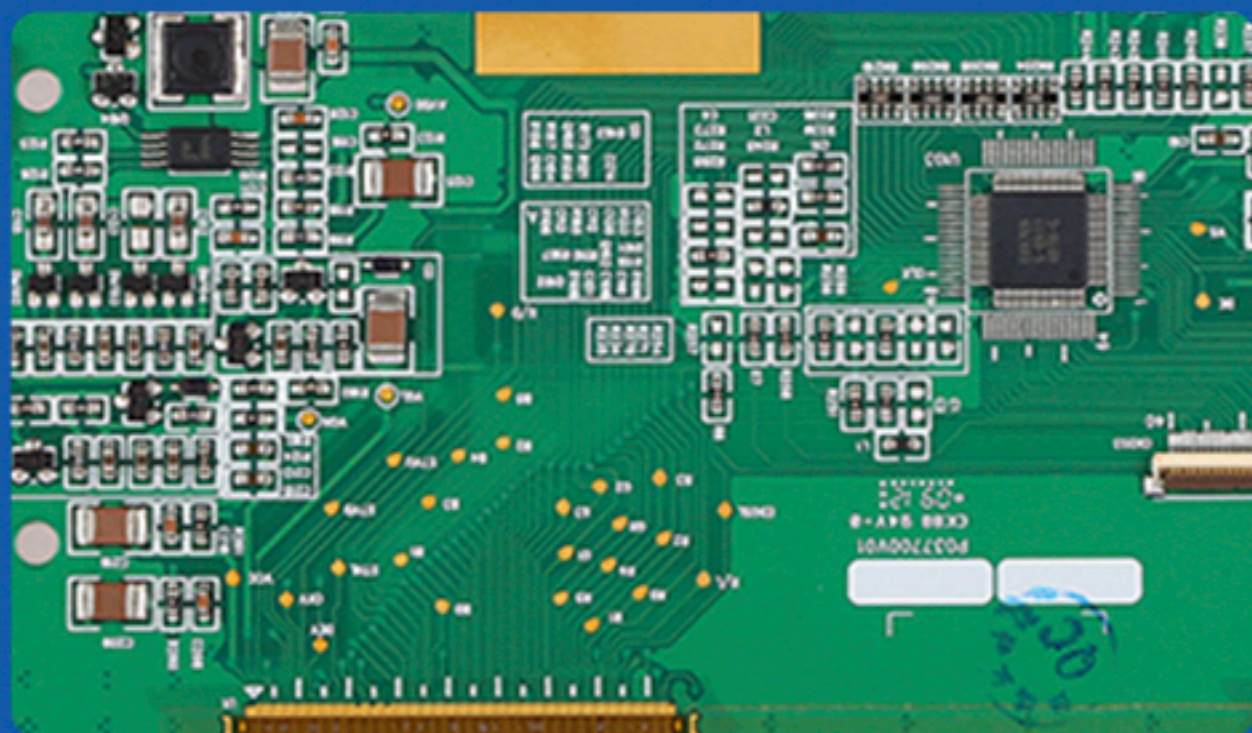

Resistance,Capacitance and Audion Mixed Mounting

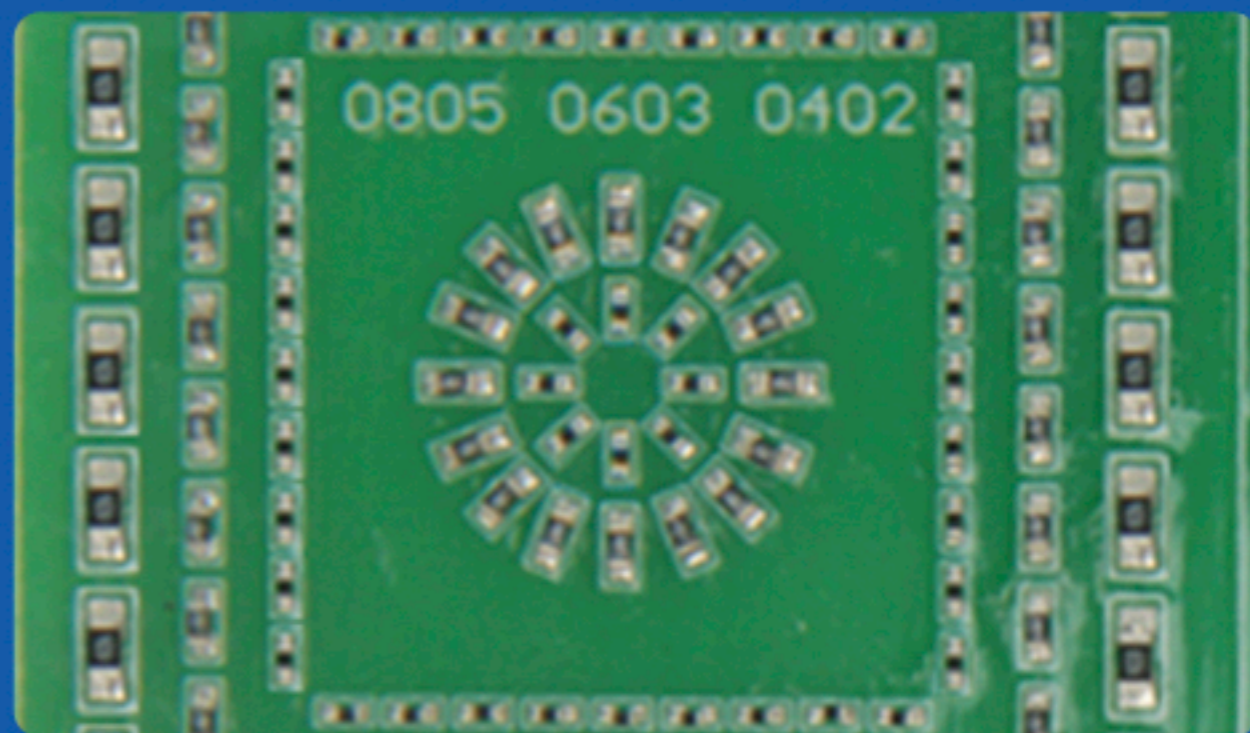

0402、0603、0805 Each Angel Mounting

PRODUCT DETAILS

SMT AUTOMATIC VISION PICK AND PLACE MACHINE

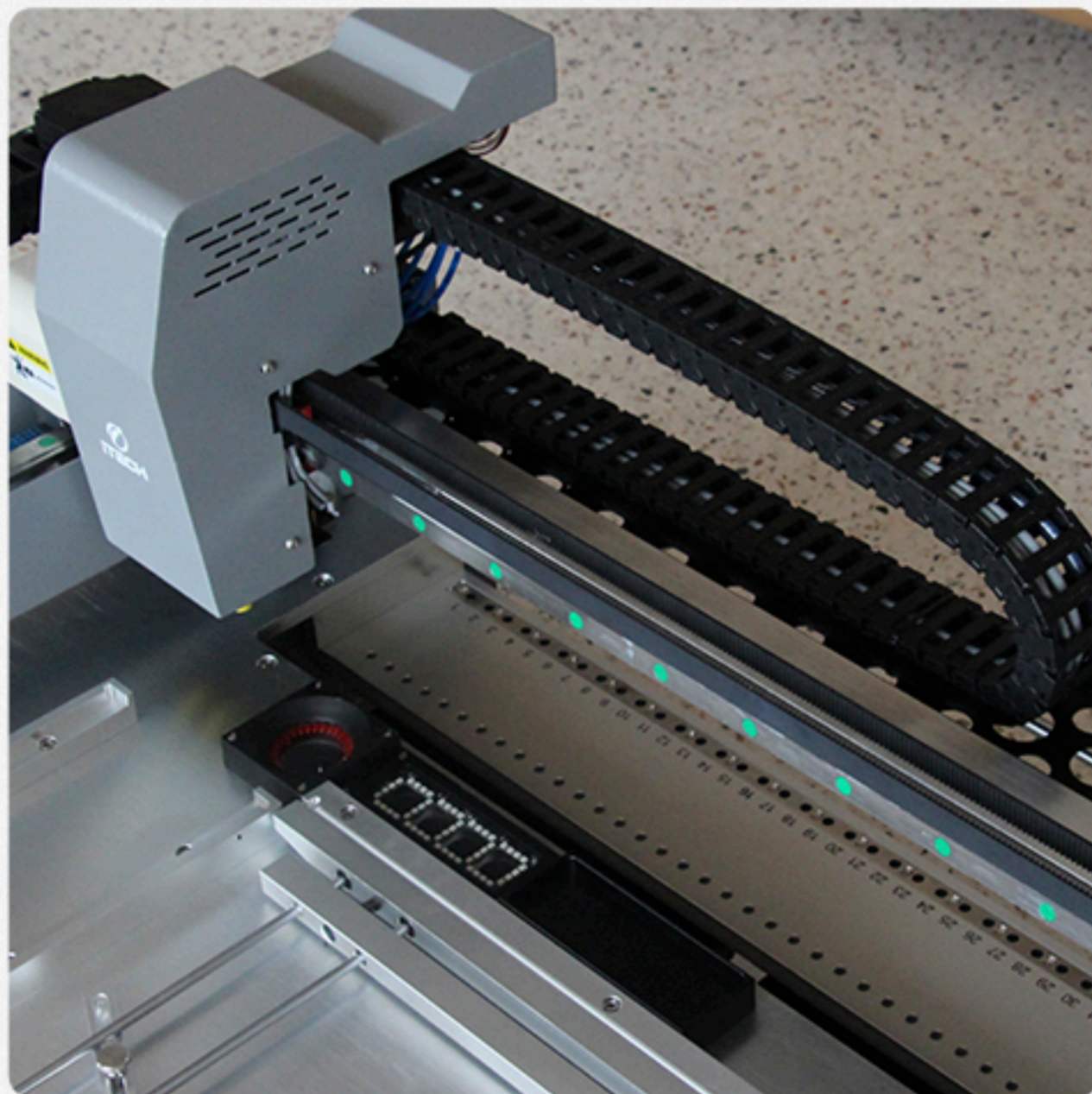

01 GUIDE

TAIWAN HIWIN LINEAR GUIDER WAY

Both XY axis adopts Taiwan HIWIN linear guide rail, more stable and more accurate.



02 TRANSMISSION

TRANSMISSION BELT

Japan UNITTA 15mm width belt With much good wear resistance and aging resistance Not easy to deform and stretch, makes the machine have a high precision

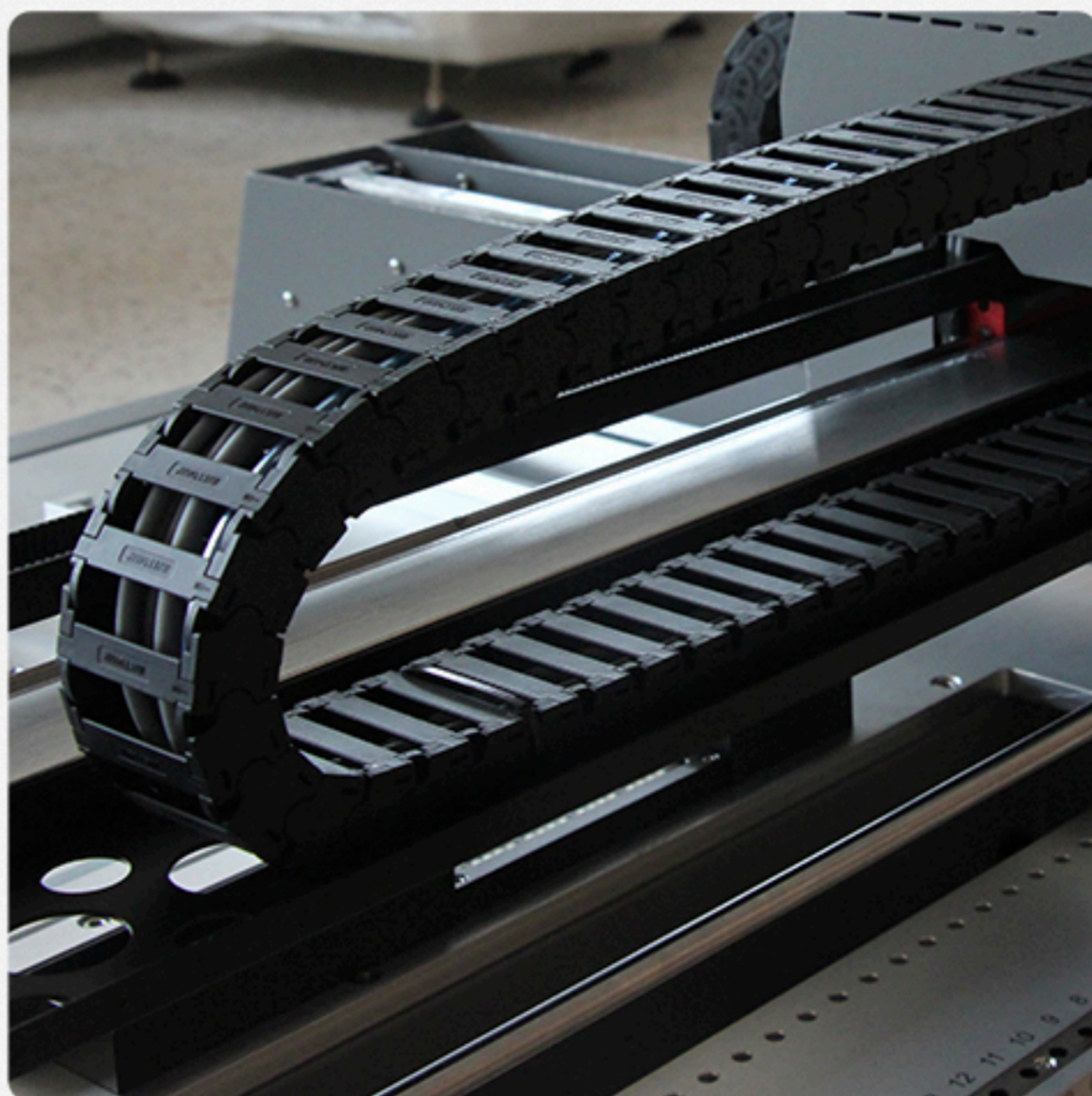

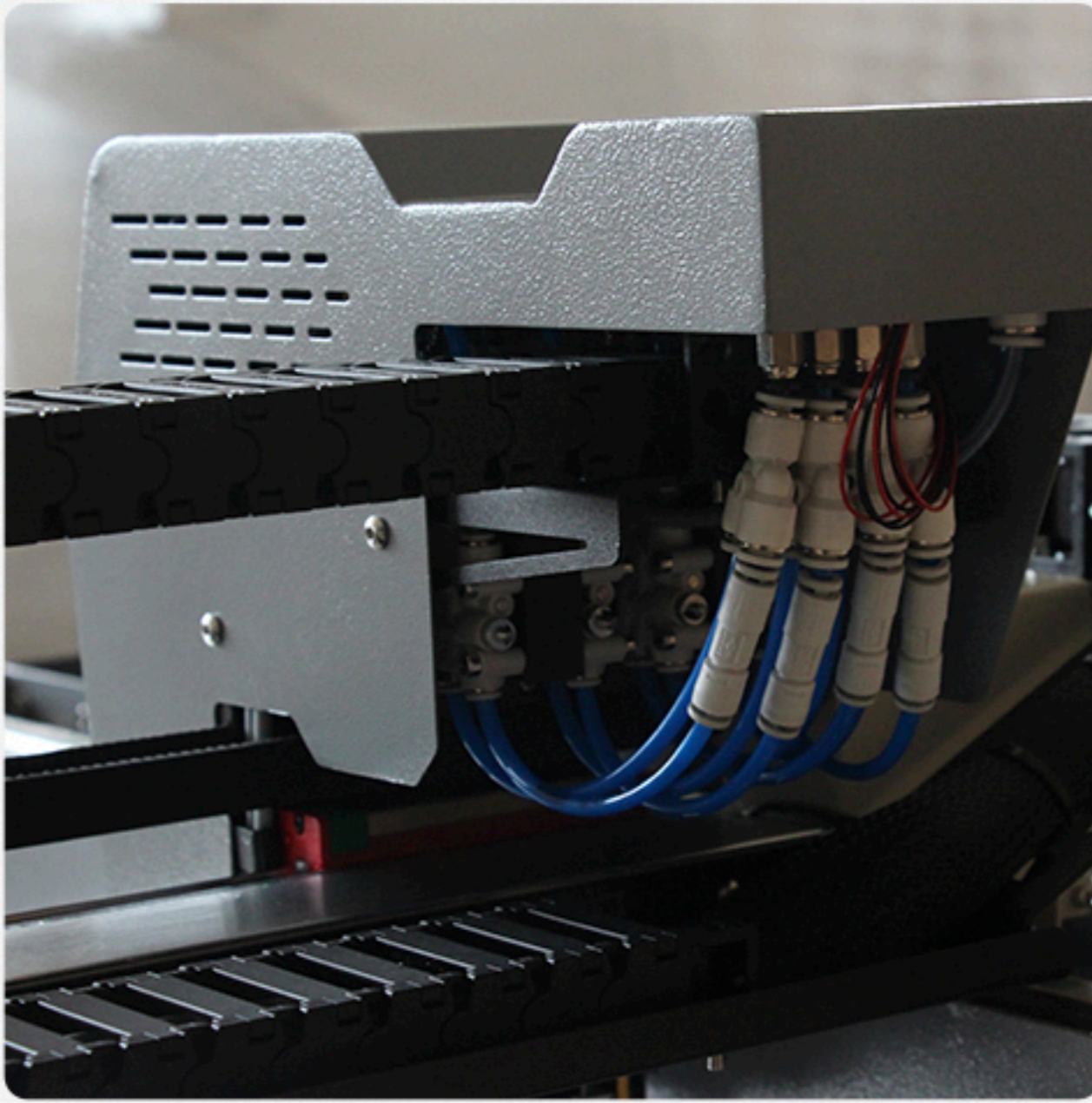

VACUUM

VACUUM GENERATOR

Utilize positive pressure air source to generate negative pressure Efficient, clean, strong negative pressure ability Can stably absorb large and small devices for a long time

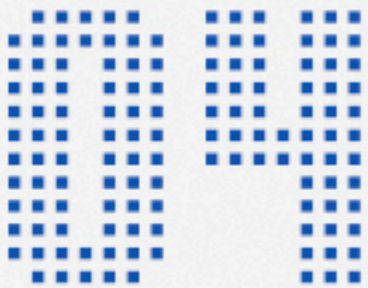

MOUNT

LIGHT BAR MOUNTING

Can be modified to mount 0.6, 0.9, 1.2 meters long light bar mount

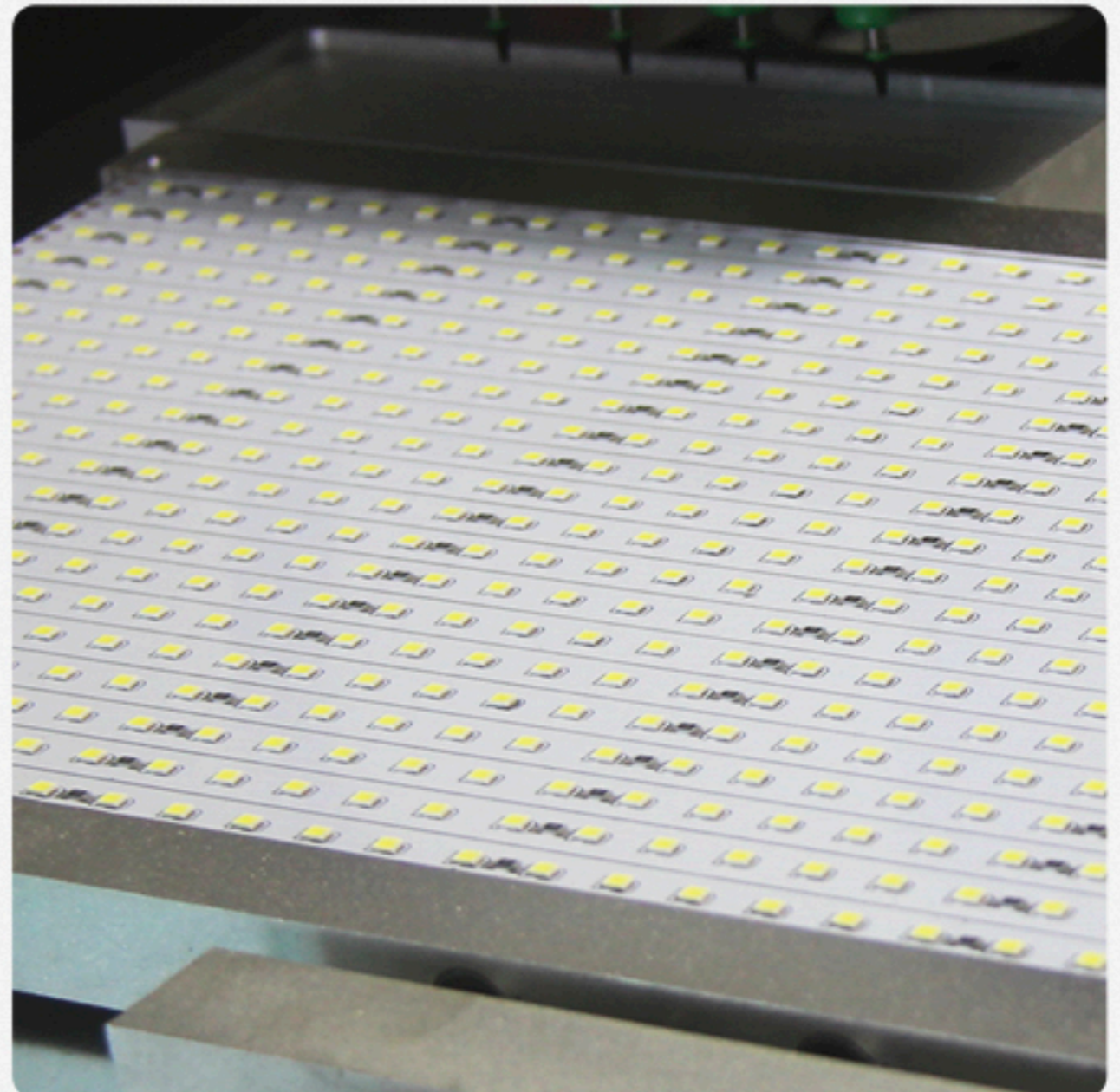

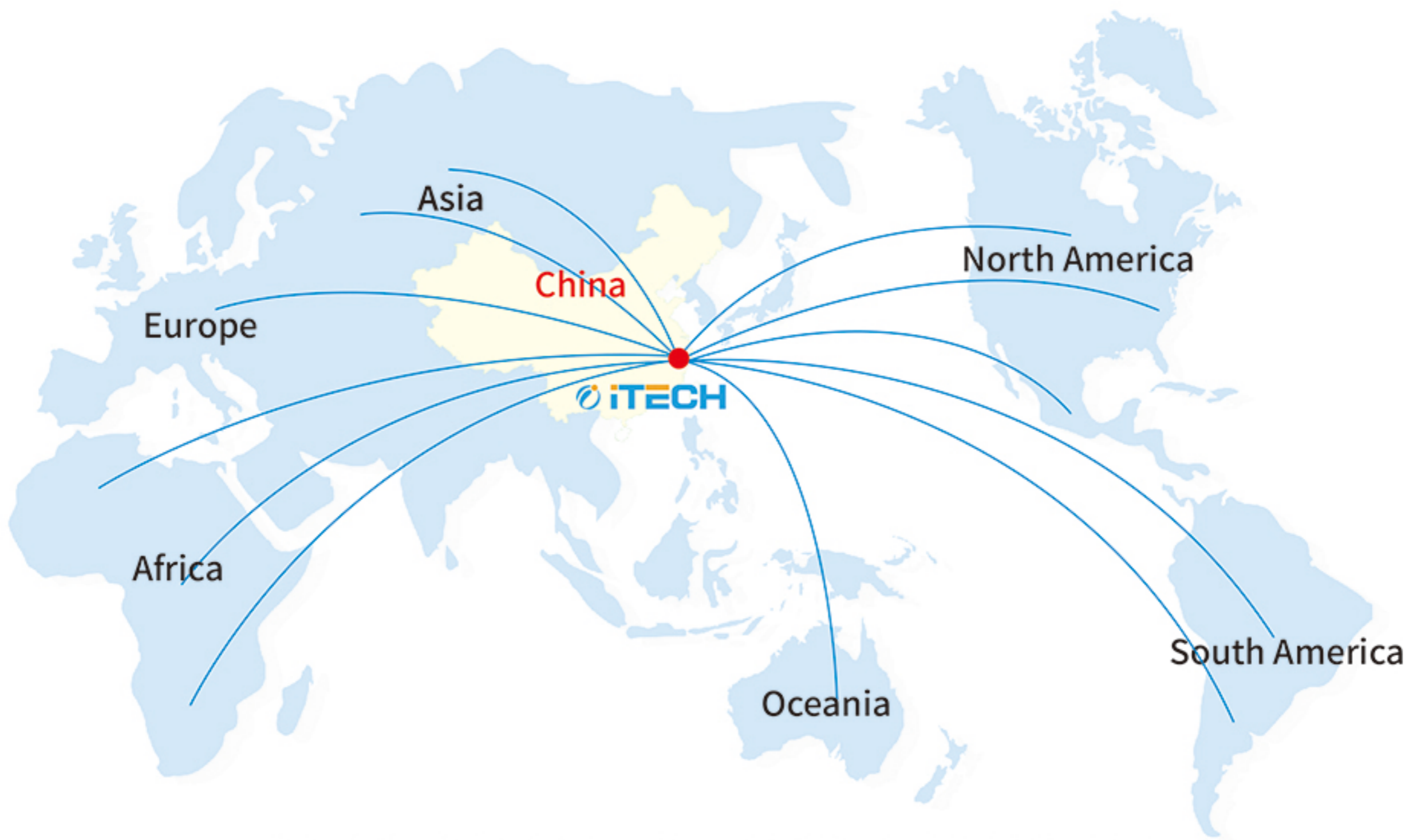

INTERNATIONAL SERVICE CENTER



Cairo, Egypt



New Delhi, India



Koln, Germany



Madrid, Spain



Kyeongki-Do,
South Korea



Buenos Aires
Argentina



Istanbul Turkey



Sao Paulo Brazil



Moscow, Russia



Zhejiang Huaqi Zhengbang Automation Technology Co., Ltd.

No.1, Shanha Road, Nanming Mountain Street, Liandu District, Lishui City, Zhejiang Province, China.

Service Call: 0086-577-86701181

Fax : 0086-577-85398666

Website : www.itechsmt.com