

---

**300 SERIES  
CHAMBER VACUUM SEALER**

---

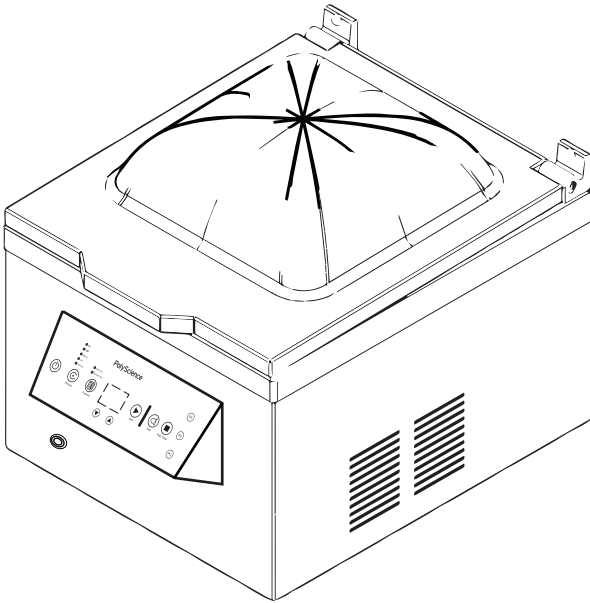

**USER'S GUIDE**

---

# CONTENTS

<b>Important Safeguards</b> .....	<b>4</b>
<b>Introduction</b> .....	<b>6</b>
<b>Package Contents</b> .....	<b>7</b>
<b>Seal Bar Installation</b> .....	<b>7</b>
<b>Components</b> .....	<b>8</b>
<b>Control Panel</b> .....	<b>9</b>
<b>Digital Display &amp; LED Status</b> .....	<b>13</b>
<b>Set-Up</b> .....	<b>14</b>
Electrical Power .....	14
Creating a Preset Program .....	14
Vacuum / Seal Preset .....	15
Marinate Preset .....	15
Making a Heat-Seal Bag from a Roll .....	16
<b>Day-to-Day Operation</b> .....	<b>17</b>
Turning the Unit On .....	17
Placing the Heat-Seal Bag in the Vacuum Chamber .....	17
Selecting the Vacuum Level .....	17
Setting the Seal Time .....	18
Automatic Vacuuming Packaging .....	18
Bags .....	18
Canisters & Bottles .....	19
Manual Vacuuming Packaging .....	20
Marinating or Pickling Food Item .....	21
Bag Marinating .....	21
Canister Marinating .....	22
<b>Running a Preset Program</b> .....	<b>23</b>
<b>Calibration</b> .....	<b>24</b>

# CONTENTS (CONTINUED)

Restoring Factory Default Settings .....	25
Routine Cleaning .....	25
Troubleshooting .....	26
Error Messages.....	27
Technical Specifications .....	28
Replacement Bags.....	29
Disposal .....	29
Warranty.....	30

# IMPORTANT SAFEGUARDS

**When using this electrical appliance, basic safety precautions should always be observed, including the following:**

1. Do not touch hot surfaces.
2. Do not operate this Vacuum Sealer with a damaged power cord or plug, or if it has been dropped, damaged or malfunctions.
3. Do not let power cord touch hot surfaces or hang over the edge of table or counter.
4. Unplug from electrical outlet when not in use.
5. To avoid the possibility of personal injury, always unplug the Vacuum Sealer from the electrical outlet before cleaning the unit.
6. Do not immerse Vacuum Sealer or power cord in water or any other liquid.
7. Do not touch the vacuum chamber lid, vacuum chamber or seal bar while the unit is operating.
8. Do not use an extension cord with this Vacuum Sealer.
9. This Vacuum Sealer is intended for indoor use only; do not use outdoors.
10. Do not let this Vacuum Sealer come in direct contact with food. All foods should be placed in FDA approved boilable bags or canisters.
11. Carefully review the safety section in included literature.
12. This appliance should not be used by children. To avoid accidental injury, close supervision is necessary when this appliance is used where children may be present.
13. Do not operate in the presence of explosive and/or flammable fumes.
14. Do not use this Vacuum Sealer for other than the intended purpose.
15. Do not use this Vacuum Sealer on wet or hot surfaces or near a direct heat source.
16. To disconnect power, turn any control "Off," then unplug directly from electrical outlet; do not disconnect by pulling on the power cord.
17. This appliance is not intended for use by persons (including children) with reduced physical, sensory or mental capabilities, or lack of experience and knowledge, unless they have been given supervision or instruction concerning use of the appliance by a responsible person responsible for their safety.
18. Use only heat-seal bags, accessories and attachments.
19. Read all of the instructions carefully before using appliance.

	<p><b>WARNING:</b> This Chamber Vacuum Sealer is equipped with a grounded power cord. Connect the appliance only to earthed (grounded) power sockets. Do not use appliance if the grounding prong on the plug is missing or damaged or with a grounding adapter. Contact a qualified electrician if the plug does not fit into the electrical outlet you intend on using.</p>
---	---

	<p><b>WARNING:</b> Be careful not to touch or come in contact with the Seal Bar when Vacuum Chamber Lid is open as it may be hot. Never press the Seal button when the Vacuum Chamber Lid is open as this will apply heating power to the Seal Wire and can present a burning hazard.</p>
---	---

	<p><b>WARNING:</b> Vacuum packaging is not a substitute for refrigeration or freezing. Any perishable foods that require refrigeration must still be refrigerated or frozen after vacuum packaging. Vacuum packaging is not a substitute for canning.</p>
---	---

	<p><b>WARNING:</b> Never vacuum package garlic or fungi (such as mushrooms). A dangerous chemical reaction takes place when air is removed, causing these foods to be dangerous if ingested.</p>
---	--

	<p><b>WARNING:</b> As with any storage container, it is important to inspect food that has been vacuum packaged for spoilage prior to consumption.</p>
--	--

It is important to note that vacuum packaging cannot reverse the deterioration of foods; it can only slow down changes in quality. It is difficult to predict how long foods will retain their flavor, appearance or texture since it depends on the age and condition of the food when it was vacuum packaged.

# INTRODUCTION

Thank you for choosing the PolyScience 300 Series Chamber Vacuum Sealer. It is one of the strongest and easiest to use vacuum packaging systems available. With this Vacuum Sealer, you will be able to keep food fresher and for longer periods of time in your freezer, refrigerator and pantry. You can also use your Chamber Vacuum Sealer to quickly marinate meats, poultry and fish or pickle fruits and vegetables.

The 300 Series Chamber Vacuum Sealer is a chamber vacuum system which offers two distinct advantages over non-chamber, external bag type units. First, a much higher level of vacuum can be achieved, which means a longer shelf life for foods that you package. Secondly, liquids and liquid-rich foods such as fresh meats, fish, soup and stews can be effectively vacuum packaged. Marinated vegetables and meats can also be packaged quickly and easily, without mess.

The 300 Series Chamber Vacuum Sealer also allows you to package a wide variety of sizes and shapes. Prep and store smaller, individual portions as well as bulk items. The maximum bag with is 12 inches (30.5 cm).

We recommend that you begin operating your 300 Series Chamber Vacuum Sealer immediately to confirm that it is operating properly. In the unlikely event that the unit was damaged during shipping or does not operate properly, contact:

**PolyScience**

6600 W. Touhy Avenue

Niles, IL 60714 USA

Phone: 1.800.229.7569

1.847.647.0611

Email: [culinary@polyscience.com](mailto:culinary@polyscience.com)

Be sure to activate your new PolyScience Vacuum Sealer warranty at **[www.cuisinetechology.com](http://www.cuisinetechology.com)**

# PACKAGE CONTENTS

The items included with your 300 Series Chamber Vacuum Sealer are:

- 300 Series Chamber Vacuum Sealer
- Seal Bar Assembly (must be installed prior to use)
- External Vacuum Hose
- User's Manual
- Quick-Start Guide
- 6 x 10 in. chamber vacuum heat seal bags (15)
- 8 x 12 in. chamber vacuum heat seal bags (15)
- 12 x 14 in. chamber vacuum heat seal bags (15)

# SEAL BAR INSTALLATION

Before plugging the unit in, locate the seal bar found in the top foam packaging insert. Place the seal bar onto the two posts located inside the Vacuum Chamber. DO NOT remove the non-stick tape covering the seal bar; this tape is required for proper operation.

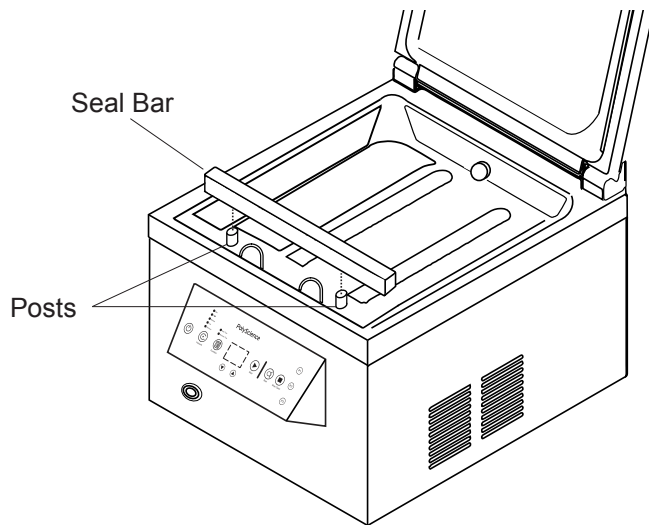

# COMPONENTS

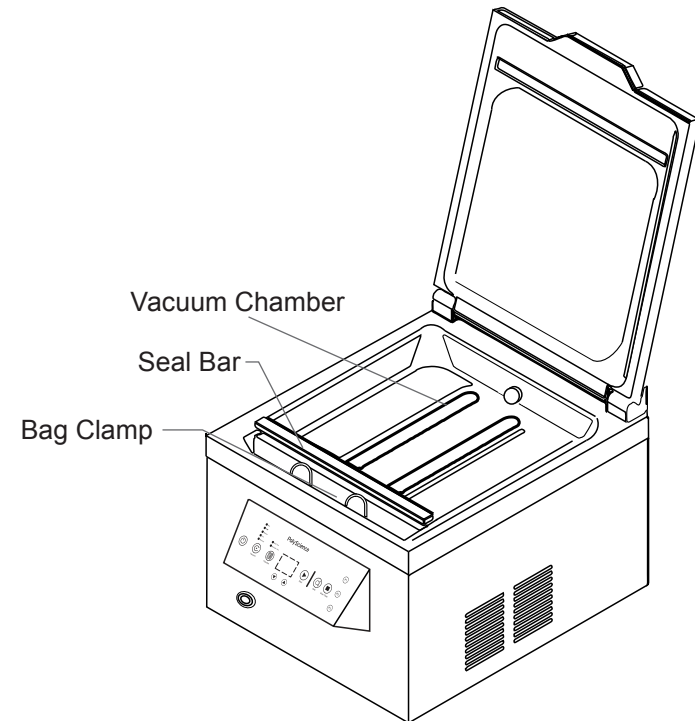
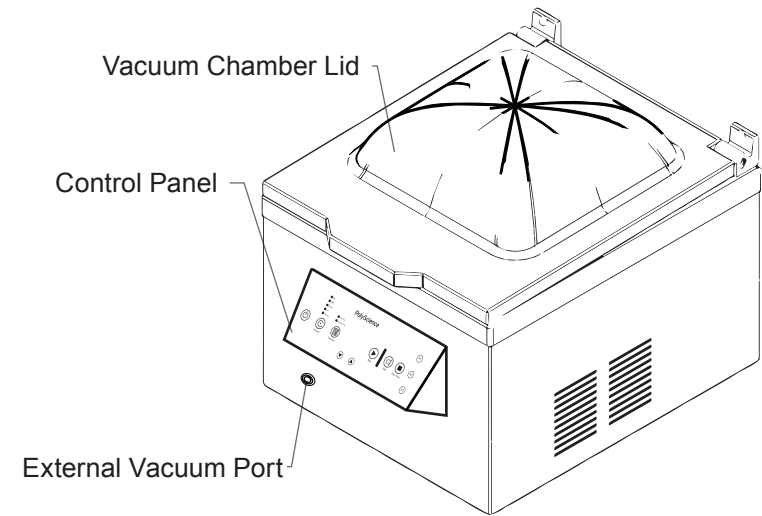

# CONTROL PANEL

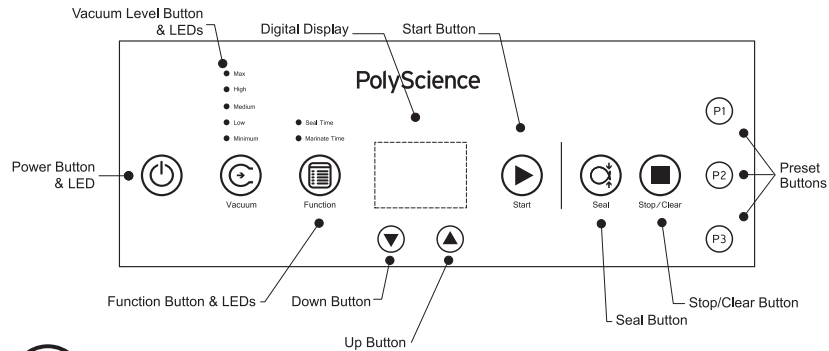

**Power Button** — This button turns the Chamber Vacuum Sealer On and Off. When the unit is powered On, the blue LED associated with the last selected *Vacuum Level* lights and the last used *Marinate Time* and *Seal Time* settings are each displayed for two seconds. The display reads 00 when the unit is ready for use.



**Vacuum Level Button** — This button allows you to set the desired *Vacuum Level*. Each time it is pressed, one of the blue LEDs above the button illuminates. Any of the five *Vacuum Levels* may be selected:

<b>Vacuum Level</b> (LED lights)	<b>Time</b> (seconds)	<b>InHg</b> (Inches of Mercury)*	<b>Torr</b> (Millimeters of Mercury)*	<b>InHg</b> (Gauge — Inches of Mercury)**	<b>Torr</b> (Gauge — Millimeters of Mercury)**
Maximum	30-45	0.35	9	-29.55	-750
High	22.8	1.02	26	-28.88	-733
Medium	17.3	2.24	57	-27.66	-702
Low	13.2	4.09	104	-25.81	-655
Minimum	10	6.42	163	-23.48	-596

\* Values are approximate and based on an ambient temperature of 25°C (77°C) at sea level (29.9 InHg / 760 Torr).

\*\* Gauge vacuum equivalents are listed to provide a reference to vacuum sealers with vacuum gauges.



**Function Button** — This button is used to select and set the *Marinate Time* and/or the *Seal Time*. Pressing the button toggles between the choices. The LED associated with the selected function lights blue when selected. The desired *Marinate Time* or *Seal Time* is set using the Down / Up arrow buttons.

**Marinate Time** — This is particularly useful for marinating and pickling. Allows you to set the *Marinate Time* in 9 minute cycles, with each cycle consisting of a vacuum/hold/release process. Each vacuuming step takes approximately one minute (depending on the *Vacuum Level* set) and each hold step takes approximately 8 minutes. At the end of each cycle, the vacuum is released. If Sealing has been activated, the bag will be sealed prior to the release of vacuum in the final cycle. The maximum number of vacuum/hold cycles is 11 (99 minutes).

*EXAMPLE: If a marinate time of 27 minutes is selected, the unit will pull the vacuum at the selected level, hold it for 8 minutes and then release the vacuum. This vacuum/hold cycle is then repeated two more times for a total marinate time of approximately 27 minutes.*

When 00 is selected, the marinate function is not active.

**Seal Time** — This function allows you to set the amount of time needed to seal the storage bag and helps ensure that bags of different thicknesses are sealed properly. The *Seal Time* may be set anywhere from 00 to 06 seconds. If you do not want to seal the bag, the *Seal Time* should be set to 00.



**Down / Up Buttons** — These buttons are used in conjunction with the Function button to set the *Marinate Time* and/or *Seal Time*. The Down button decreases the displayed value; the Up button increases the displayed value.



**Start Button** — Pressing this button initiates the marinate process, vacuum and/or sealing process. The process may be set either manually or by selecting one of the three Preset programs (P1, P2, P3).



**Seal Button** — This button is used to immediately begin sealing using the last programmed *Seal Time*; it overrides any process currently in progress and initiates sealing. If vacuuming is in process, vacuuming will continue until the sealing process is complete. If marinating is in process, sealing will be initiated (and no further vacuum will be pulled). Following the completion of the sealing process, the remaining chamber vacuum will be released and product can be removed. If *Seal Time* is set to 00, pressing the Seal button has no effect on the process in progress.





**Stop / Clear Button** — Pressing this button after entering a *Marinate Time*, *Seal Time* or Calibration value resets the Digital Display to 00 and activates a single one-second audible signal.

Pressing it while a process is running immediately stops the process and activates two one-second beeps; the chamber vacuum will be released and bag sealing will be skipped or stopped.

Pressing the Stop / Clear button a second time resets the Digital Display to 00; three one-second beeps also sound.



**Preset Buttons** — These buttons allow you to set, select and run frequently used *Vacuum Level*, *Marinate Time* and *Seal Time* combinations. Although the Presets are pre-programmed at the factory, you can change them to meet your specific requirements. The factory Presets are as follows:

<b>Preset</b>	<b><i>Vacuum Level</i></b>	<b><i>Marinate Time</i> (minutes)</b>	<b><i>Seal Time</i> (seconds)</b>
	Maximum	00	03
	Medium	00	03
	Medium	27	00

When a Preset is selected, the blue LEDs associated with the Preset's programmed settings (*Vacuum Level*, *Marinate Time* and *Seal Time*) light and the Preset ID appears on the Digital Display for two seconds. The *Marinate Time* setting will then appear on the Digital Display for two seconds followed by the *Seal Time* setting for two seconds. The unit is ready for use when the Preset ID is steadily displayed.



**Digital Display** — Displays the *Marinate Time*, *Seal Time* and Calibration values as they are input. Time is entered in minutes or seconds, depending on the function selected. It also displays the ID of a selected preset as well as the duration or the time remaining in a process as it is being run. It flashes 00 when the process is complete.

# DIGITAL DISPLAY & LED STATUS

The 300 Series Chamber Vacuum Sealer's Digital Display and LEDs convey operational information as process parameters are entered and processes run.

Event	Vacuum Level LED	Marinate Time LED	Seal Time LED	Digital Display
Power On	Last selected level LED flashes for two seconds and then on steady	Off	Off	00 for two seconds Previous <i>Marinate Time</i> value for two seconds Previous <i>Seal Time</i> value for two seconds 00 steady until Start or Preset Button pressed
Set <i>Vacuum Level</i>	Initially on steady at last selected level, changes when a different level is selected	Off	Off	00
Set <i>Marinate Time</i>	LED for last selected level on steady	On when Function button pressed once	Off	Current <i>Marinate Time</i> setting
Set <i>Seal Time</i>	LED for last selected level on steady	Off when Function button pressed to advance to <i>Seal Time</i>	On when Function button pressed to advance from <i>Marinate Time</i> to <i>Seal Time</i>	Current <i>Seal Time</i> setting

# SET-UP

Your PolyScience 300 Series Chamber Vacuum Sealer is simple to set up and operate.

## Electrical Power

1. Plug the power cord into a properly grounded electrical outlet.

	<p><b>WARNING:</b> Make sure that the electrical outlet is the same voltage and frequency as your Chamber Vacuum Sealer. The correct voltage and frequency are indicated on a label on the rear of the unit. The use of extension cords is not recommended.</p>
---	---

2. Press . The unit will run through a brief (~6 seconds) start-up sequence.
  - The LED next to the last selected Vacuum Level will flash for two seconds and then remain lit.
  - 00 will appear on the digital display for two seconds.
  - The last selected Marinate Time will appear on the display for two seconds.
  - The last selected Seal Time will appear on the display for two seconds.
  - 00 will be displayed steadily on the readout, indicating that the unit is ready for use.











## Creating a Preset Program

The 300 Series Chamber Vacuum Sealer's presets allow you to create and run frequently used Vacuum Level, Seal Time and Marinate Time combinations. These are particularly convenient if you usually use the same settings for processing large batches or particular types of foods.













	<p><b>IMPORTANT:</b> If you intend to use a preset for use with external canisters, you should not include a seal step.</p>
---	---



## Vacuum / Seal Preset

1. Press .
2. Press  until the LED adjacent to the desired *Vacuum Level* lights.
3. Press  until the *Seal Time* LED lights.
4. Press the  and/or  buttons until the desired setting appears on the Digital Display. Enter a value of 00 if you want the bag to remain unsealed.
5. Press and hold the preset button (,  or ) you want to associate with this vacuum / seal combination for ten seconds. Two one-second beeps sound and the preset ID (P1, P2, P3) appears on the Digital Display.
6. Press  to run the preset program; press  if you do not wish to run the program at this time (the Digital Display will reset to 00).





## Marinate Preset

1. Press .
2. Press  until the LED adjacent to the desired *Vacuum Level* lights.
3. Press  until the LED adjacent to *Marinate Time* lights.
4. Press the  and/or  buttons until the desired *Marinate Time* appears on the digital display.
5. If you wish to seal the bag once the marinating process is complete, press  until the LED adjacent to *Seal Time* lights then use the  and/or  buttons to set the desired seal time.
6. Press and hold the preset button (,  or ) you want to associate with the program for ten seconds. Two one-second beeps sound and the preset ID (P1, P2, P3) appears on the Digital Display.
7. Press  to run the preset program; press  if you do not wish to run the program at this time (the Digital Display will reset to 00).

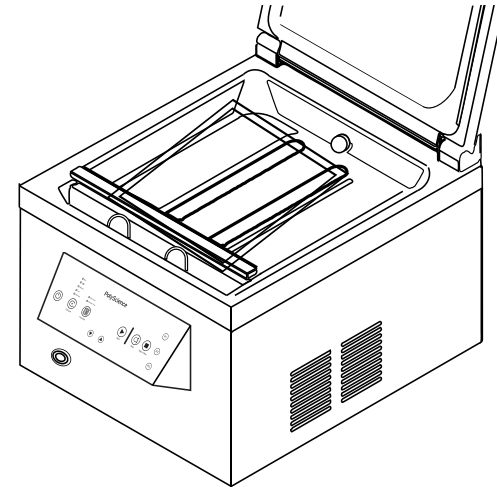
## Making a Heat-Seal Bag from a Roll

1. Pull out a length of roll sized to fit the item you wish to vacuum package. Be sure to allow for at least 1.75 inch (4.5 cm) of space at the top and the bottom of the food item.
2. Cut the roll to size.
3. Place one end of the cut piece across the seal bar in the Vacuum Chamber and secure the open end of the vacuum bag in the bag clamp located in front of the seal bar. Make sure the seal bar spans the entire width of the roll and that there are no wrinkles in the bag material.



4. Close the Vacuum Chamber Lid.
5. Press  until the *Seal Time* LED lights.
6. Press the  and/or  buttons until the desired *Seal Time* settings appear on the Digital Display.
7. Press . The *Seal Time* will count down from the current setting to 00. Three one-second audible tones will sound when the sealing process is complete.
8. Open the Vacuum Chamber Lid, remove the bag and check for proper seal.



**NOTE:** A positive seal will look “clear” upon inspection. If the seal is spotty or incomplete, increase the seal time; if the seal is white or milky, decrease the seal time.

# DAY-TO-DAY OPERATION

## Turning the Unit On

Press . The unit will run through a short start-up sequence during which the last selected *Vacuum Level*, *Marinate Time* and *Seal Time* will be displayed (see *Set-Up*, page 14). The unit is ready for use when 00 is displayed continuously on the readout.



**NOTE:** The Chamber Vacuum Sealer stores the most recently used operational settings when the unit is turned Off or if electrical power is disrupted.

## Placing the Heat-Seal Bag in the Vacuum Chamber

Correct placement of the heat-seal bag within the Vacuum Chamber is crucial to the vacuuming and sealing process. Here are some guidelines to follow that will help ensure that your products are properly vacuum packaged.

1. Allow at least 1.75 inch (4.5 cm) of space between the top of the food item and the open end of the bag.
2. Lay bag flat in the Vacuum Chamber with the opening of the bag across the seal bar. If packaging a bag containing liquids or wet product, keep the contents of the bag below the height of the seal bar.
3. Secure the open end of the vacuum bag in the bag clamp located in front of the seal bar.

## Selecting the Vacuum Level

Your 300 Series Chamber Vacuum Sealer features five *Vacuum Levels*. Depending on the *Vacuum Level* selected, it may take from 10 to 45 seconds to pull the desired vacuum (see *Control Panel Overview*, *Vacuum Level Button*, page 9).





**NOTE:** Delicate foods (such as seafood, berries, peas, etc.) may be crushed or damaged if packaged using too great a *Vacuum Level*.

Press  until the LED adjacent to the desired *Vacuum Level* lights.

## Setting the Seal Time

The Seal Time on your 300 Series Chamber Vacuum Sealer is adjustable to help ensure proper sealing when bags with different wall thicknesses are used. The *Seal Time* setting can be set from 00 (no sealing) to 6 seconds in 0.5 second increments.

1. Press  until the *Seal Time* LED lights; the last selected *Seal Time* will appear on the Digital Display.
2. Press the  and/or  buttons until the desired setting appears on the Digital Display.

## Automatic Vacuum Packaging

### Bags

1. Select the *Vacuum Level* and set the *Seal Time* as required (see *Selecting the Vacuum Level* and *Setting the Seal Time*, page 17-18).
2. Open the Chamber Vacuum Lid.
3. Place the food item in a suitably sized heat-seal bag and secure in the Chamber Vacuum Sealer (see *Placing the Heat-Seal Bag in the Vacuum Chamber*, page 17).
4. Close the Vacuum Chamber Lid.
5. Press . The vacuum and seal process will proceed as follows.
  - The vacuum pump turns On and the LED associated with the selected *Vacuum Level* begins flashing; the LEDs for lower *Vacuum Levels* light as those levels are achieved. The time on the Digital Display counts up (in seconds) until the selected *Vacuum Level* is achieved.
  - When the selected *Vacuum Level* is achieved, the LED associated with the level lights steady and the vacuum pump turns Off.
  - The seal step is initiated if *Seal Time* is 01 or greater.
  - The time remaining in the seal step is displayed on the digital readout.
  - When the display reaches 00, it begins flashing and three one-second audible signals sound to indicate that the process is complete. You may also notice the bag tightening around the product as air is let back into the vacuum chamber.
6. Open the Vacuum Chamber Lid.
7. Open the clamp, remove the bag and check for proper vacuum and seal.



**NOTE:** The quality of the vacuum can be checked by looking at the tightness of bag around the product. If you notice air pockets, increase the vacuum one level.



**NOTE:** A positive seal will look “clear” upon inspection. If the seal is spotty or incomplete, increase the seal time; if the seal is white or milky, decrease the seal time.



**NOTE:** You can press  at any point during vacuuming or sealing to cancel the process.



**WARNING:** Be sure to store vacuum packaged items properly after sealing. All perishable foods must be refrigerated or frozen to prevent spoilage. Vacuum packaging is not a substitute for canning.

### Canisters & Bottles

Your 300 Series Chamber Vacuum Sealer can also be used for the vacuum sealing of canisters as well as bottles with vacuum bottle stoppers.



**WARNING:** When vacuum packaging product in canisters or bottles, always set the seal time to 00. This prevents the seal bar from heating.

When sealing powdered or granulated foods in canisters, cover them with a paper towel before vacuuming to prevent the food from traveling into the vacuum system.

When sealing bottles, allow at least 1 inch (2.5 cm) of space between the bottom of the stopper and the liquid in the bottle.

1. Place the canister lid on the canister or the vacuum bottle stopper in the bottle.
2. Attach the vacuum hose to the front panel External Vacuum Port.
3. Attach the vacuum hose to the vacuum port on the canister lid or bottle stopper.
4. Place vacuum port in the “vacuum” position (canisters only).
5. Adjust the *Vacuum Level* as required (see *Selecting the Vacuum Level*, page 17).



6. Press . The vacuum process will proceed as follows:
  - The vacuum pump turns On and the LED associated with the selected Vacuum Level begins flashing; the LEDs for lower Vacuum Levels light as those levels are achieved. The time on the Digital Display counts up (in seconds) until the selected Vacuum Level is achieved.
  - When the selected Vacuum Level is achieved, the LED associated with that level lights steady and the vacuum pump turns Off and three one-second audible signals sound to indicate that the process is complete.
7. Place the vacuum port on the canister in the “Closed” or “Lock” position (canisters only).
8. Remove the vacuum hose from the canister or bottle.



**NOTE:** Store vacuum sealed bottles vertically, making sure that the liquid is not in contact with the stopper.

### Manual Vacuum Packaging

Delicate foods (such as seafood, berries, peas, etc.) may be crushed or damaged while liquids or wet products may boil or be drawn out of the bag if packaged using automatic vacuum packaging. Manual vacuuming and sealing gives you more precise control over the vacuum process to help prevent these problems.

1. Select the Vacuum Level and set the Seal Time as required (see *Selecting the Vacuum Level and Setting the Seal Time*, page 17-18).
2. Open the Vacuum Chamber Lid.
3. Place the food item in a suitably sized heat-seal bag and secure in the Vacuum Chamber (see *Placing the Heat-Seal Bag in the Vacuum Chamber*, page 17).
4. Close the Vacuum Chamber Lid.
5. Press  and observe the bag closely as air is removed.
6. When the desired vacuum is achieved, press  to seal the bag and complete the manual vacuum packaging process. Three one-second audible tones will sound to indicate that the packaging process is complete.
7. Open the Vacuum Chamber Lid.
8. Open the clamp, remove the bag and check for proper vacuum and seal.









## Marinating or Pickling Food Items

You can use your 300 Series Chamber Vacuum Sealer to quickly marinate or pickle products in either bags or canisters.

Marinating/pickling time is set in 9 minute cycles, with each cycle consisting of two main steps: vacuum and hold. The maximum number of vacuum/hold cycles is 11 (99 minutes).

Each vacuum step takes approximately 1 minute (depending on the Vacuum Level set) and each hold step takes approximately 8 minutes. At the end of each cycle, the vacuum is released. If sealing has been activated and a bag is being used, the bag is sealed at the end of the final cycle.

### Bag Marinating

1. Adjust the *Vacuum Level* as required (see *Selecting the Vacuum Level*, page 17).
2. Press . The LED adjacent to *Marinate Time* will light.
3. Press the  and/or  buttons until the desired *Marinate Time* appears on the Digital Display.
4. Press . The LED adjacent to *Seal Time* will light.
5. Press the  and/or  buttons until the desired *Seal Time* appears on the Digital Display. Set *Seal Time* to 00 if you wish to leave the bag unsealed.
6. Press  until the LED adjacent to *Marinate Time* lights.
7. Open the Vacuum Chamber Lid.
8. Place the food item you wish to marinate and the marinade in a suitably sized heat-seal bag and secure in the Vacuum Chamber (see *Placing the Heat-Seal Bag in the Vacuum Chamber*, page 17).
9. Close the Vacuum Chamber Lid.
10. Press . The marinate process will proceed as follows:
  - The vacuum pump turns On and the LED associated with the selected *Vacuum Level* begins flashing; the LEDs for lower *Vacuum Levels* light as those levels are achieved.
  - When the selected *Vacuum Level* is achieved, the LED associated with that level lights steady and the vacuum pump turns Off and a hold cycle begins. The Digital Display begins counting down (in minutes) from the original *Marinate Time* setting.





- If the *Marinate Time* was set for more than one cycle (18 minutes or more), the vacuum and hold process repeats until all time has elapsed.
- A seal step is initiated if Seal Time is 01 or greater and the time remaining in the seal step is displayed on the digital readout.
- When the display reaches 00, it begins flashing and three one-second audible signals sound to indicate that the process is complete.

11. Open the Vacuum Chamber Lid.

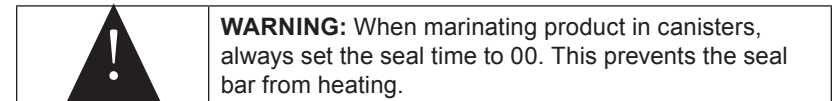
12. Open the clamp, remove the bag and check for proper seal (as needed).

### Canister Marinating



1. Place the food item and marinade in the canister and place lid on the canister.
2. Attach the vacuum hose to the front panel External Vacuum Port.
3. Attach the vacuum hose to the vacuum port on the canister lid.
4. Place vacuum port in the “vacuum” position.
5. Adjust the *Vacuum Level* as required (see *Selecting the Vacuum Level*, page 17).
6. Press . The LED adjacent to *Marinate Time* will light.
7. Press the  and/or  buttons until the desired Marinate Time appears on the Digital Display.
8. Press . The vacuum process will proceed as follows:
  - The vacuum pump turns On and the LED associated with the selected *Vacuum Level* begins flashing; the LEDs for lower *Vacuum Levels* light as those levels are achieved. The Digital Display begins counting down (in minutes) from the original *Marinate Time* setting.
  - When the selected *Vacuum Level* is achieved, the LED associated with that level lights steady and the vacuum pump turns Off and a hold cycle begins. The Digital Display continues counting down.

- If the *Marinate Time* was set for more than one cycle (18 minutes or more), the vacuum and hold process repeat until all time has elapsed. When the display reaches 00, it begins flashing and three one-second audible signals sound to indicate that the process is complete.
9. Place the vacuum port on the canister in the “Closed” or “Lock” position.
  10. Remove the vacuum hose from the canister.

## RUNNING A PRESET PROGRAM

Your 300 Series Chamber Vacuum Sealer features three Presets that allow you to set, select and run frequently used *Vacuum Level*, *Marinate Time* and *Seal Time* combinations. Although the Presets are pre-programmed at the factory, you can change them to meet your specific requirements. (See *Creating a Preset Program*, page 14).

The factory-programmed Presets are as follows:

Preset	Vacuum Level	Marinate Time (minutes)	Seal Time (seconds)
P1	Maximum	00	03
P2	Medium	00	03
P3	Medium	27	00

A Preset is run as follows:

1. Place the heat-seal bag in the Vacuum Chamber or attach the external vacuum hose to the front panel External Vacuum Port and the port on the lid of the canister.
2. Press the button associated with the preset you wish to run (P1, P2 or P3); a single one-second audible tone will sound and the ID for that preset will appear on the display (P1, P2, P3).
3. Press ▶. The vacuum packaging or marinating process will begin running. Three one-second audible tones will sound when the process is complete.
4. Remove the heat-seal bag from the vacuum chamber or detach the external vacuum hose from the External Vacuum Port and canister lid ports.

## CALIBRATION

The time it takes to achieve the desired *Vacuum Level* can be adjusted to compensate for changes in altitude and/or other requirements by shortening or lengthening the storage bag evacuation time by -5 to +45 seconds. Adding time increases the level of vacuum pulled; subtracting time decreases the level of vacuum pulled.

The *Vacuum Levels* are adjusted as follows:

1. Press ⏻ to turn the Chamber Vacuum Sealer Off.
2. Press Ⓢ and Ⓜ hold and simultaneously while pressing ⏻.
3. Continue holding Ⓢ and Ⓜ until CL appears on the Digital Display (about 3 seconds).
4. Release Ⓢ and Ⓜ; 00 (or the most recent calibration adjustment value) will appear on the display.
5. Use the ▼ and/or ▲ buttons to decrease or increase the vacuum time.
6. Press Ⓢ and Ⓜ simultaneously to save the updated calibration information; press ⏻ to cancel the calibration.
7. 00 will appear on the Digital Display indicating that the Chamber Vacuum Sealer is ready for use.

## RESTORING FACTORY DEFAULT SETTINGS

You can restore your Chamber Vacuum Sealer to the original factory settings as follows:

1. Press ⏻ to turn the Chamber Vacuum Sealer Off.
2. Press ▶ and ■ hold and simultaneously while pressing ⏻.
3. Continue holding ▶ and ■ until rS appears on the Digital Display (about 3 seconds).
4. Release the ▶ and ■ buttons. Your unit has now been reset to the original factory settings.

	Vacuum Level	Marinate Time	Seal Time
Manual	Maximum	00	03
Preset 1	Maximum	00	03
Preset 2	Medium	00	03
Preset 3	Medium	27	00
Calibration Adjustment	00 s	N/A	N/A

# ROUTINE CLEANING

Always clean and dry your Chamber Vacuum Sealer completely after use. Be sure to protect it from contact with equipment or other objects that could damage its control panel when storing.



**WARNING:** Always disconnect your Vacuum Sealer from the electrical power outlet before cleaning.

1. Press  to turn the Chamber Vacuum Sealer Off and then unplug the unit from the electrical outlet.
2. Remove seal bar by lifting up and out of the Vacuum Chamber.
3. Clean the various components as follows:

**External Surfaces** — Use a clean, damp cloth and mild soap to remove dust, crumbs and spilled liquids.

**Seal Bar** — Use a soft brush to gently remove crumbs or other materials.

**Vacuum Chamber** — Remove crumbs and loose debris and then wipe down all internal surfaces using a clean cloth and food-safe sanitizer.

**External Vacuum Hose** — Immerse in hot, soapy water; rinse thoroughly with clean hot water. Dry completely before use.

# TROUBLESHOOTING

## Vacuum Sealer will not turn On.

- Unit not plugged in. Check that the electrical cord is plugged into a working, grounded electrical outlet.
- Unit plugged in but not turned On. Press .
- Damaged or worn electrical power cord. **DO NOT USE UNIT; RETURN FOR REPAIR.**

## Vacuum Sealer does not pull a complete vacuum with bag.

- *Vacuum Level* and/or *Seal Time* may be insufficient; increase as required.
- Edge of bag not across seal bar; properly position bag.
- Bottom of bag mouth not clamped properly; place bottom of bag mouth in clamp and close clamp.
- Bag improperly positioned in Vacuum Chamber; reposition as required.
- Wrinkles in bag along seal bar; smooth out bag.
- Sealed end of bag (from roll) not completely sealed; check for gaps or flaws in seal.
- Crumbs or other debris on bag or seal bar; clean as required.

## Heat-Seal bag loses vacuum after being sealed.

- Bag punctured. Sharp items can put small holes in bags. Cover sharp edges with a paper towel and vacuum package in new bag.
- Out-gassing. Some fruits and vegetables can release gases if not properly blanched or frozen before packaging. Open bag and check for spoilage. If spoilage has not yet begun, consume immediately.



**WARNING:** If spoilage has begun or if in doubt, discard immediately. **DO NOT CONSUME.**

## Canisters not vacuuming properly.

- External vacuum hose not properly attached. Make sure vacuum hose is completely inserted into the lid of the canister and attached securely to the vacuum hose port on the Chamber Vacuum Sealer.
- Port on canister in incorrect position.
- Insufficient head space in canister. Allow at least 1 inch (2.5 cm) of space between the surface of the items in the canister and the lid.
- Damaged canister lid or body. Check canister, lid and seal for damage.

**Bags not sealing properly.**

- *Seal Time* insufficient; increase *Seal Time* as required.
- Bag improperly positioned along seal bar; make sure entire bag is over the seal bar and there are no wrinkles in the bag material.
- Food particles or debris in seal area of bag; wipe inside of bag clean.

**ERROR MESSAGES**

Error Code	Description	Troubleshooting
E1	Vacuum Mode Failure	<p>Ensure that the Vacuum Chamber Lid is fully closed</p> <p>Check the Vacuum Chamber Lid Gasket for any gaps, damage or debris</p> <p>Disconnect hose from the External Vacuum Port, if attached</p> <p>Contact dealer or factory</p>
E2	Seal Mode Failure	<p>Ensure that the Vacuum Chamber Lid is fully closed</p> <p>Check the Vacuum Chamber Lid Gasket for any gaps, damage or debris</p> <p>Disconnect hose from the External Vacuum Port, if attached</p> <p>Contact dealer or factory</p>
LP	Electrical Power Failure	<p>Press  to return the Chamber Vacuum Sealer to its previous operating parameters (last selected Vacuum Level, Marinate Time and Seal Time). 00 will appear on the Digital Display.</p>

	<p><b>IMPORTANT:</b> It is strongly recommended that you carefully check the food and/or integrity of the bag seal before using as the selected <i>Vacuum Level</i>, <i>Marinate Time</i> or <i>Seal Time</i> may not have been achieved prior to the loss of power.</p>
---	--

**TECHNICAL SPECIFICATIONS**

<b>Electrical Requirements:</b>	Model VSCH-300AC1B - 120 VAC, 60Hz Model VSCH-300AC2E - 240 VAC, 50Hz
<b>Overall Dimensions:</b> (L x W x H)	18.5 x 14 x 14.5 inches 47 x 35.6 x 36.8 cm
<b>Chamber Dimensions:</b> (L x W x H)	13.8 x 12 x 4.3 inches 35 x 30.5 x 11 cm
<b>Weight:</b>	50.7 lbs 23 kg
<b>Pump Type:</b>	Dry Piston
<b>Maximum Bag/Roll Width:</b>	12.0 inches 30.5 cm

# REPLACEMENT BAGS

A variety of heat-seal bags are available for your 300 Series Chamber Vacuum Sealer:

## Chamber Vacuum Heat-Seal Bags

Size (W x L)	Count	Part number
6 x 10 in. / 15.25 x 25.4 cm	250	VBF-0610
8 x 12 in. / 20.3 x 30.5 cm	250	VBF-0812
12 x 14 in. / 30.5 x 35.6 cm	250	VBF-1214

All can be ordered online at: [www.cuisinetechology.com](http://www.cuisinetechology.com)

# DISPOSAL

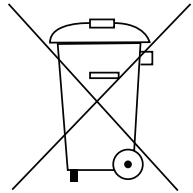

This equipment is marked with the crossed out wheeled bin symbol to indicate it must not be disposed of as unsorted municipal waste.

It is your responsibility to correctly dispose of this equipment at lifecycle-end by handing it over to an authorized facility for separate collection and recycling. By doing so, you will help to conserve natural and environmental resources and you will ensure that your equipment is recycled in a manner that protects human health.

For more information, please contact PolyScience.

# WARRANTY

This limited warranty supersedes all previous warranties on this product. This limited warranty is available for consumers only. You are a consumer if you were the original purchaser of the product at retail for personal, family or household use. PolyScience agrees to correct for the consumer, either by repair, or at PolyScience's election, by replacement, any defects in material or workmanship which develop within twelve (12) months after delivery of this product to the consumer for parts and labor. In the event of replacement, the replacement unit will be warranted for (A) ninety (90) days from the date of delivery of the replacement, or (B) the remainder of the original warranty period, whichever is longer.

If the product should require service, contact PolyScience for instructions. When return of the product is necessary, a return authorization number is assigned and the product should be shipped, transportation charges pre-paid, to the indicated service center. To insure prompt handling, the return authorization number should be placed on the outside of the package. A detailed explanation of the defect must be enclosed with the product.

Notwithstanding the above, this warranty shall not apply if the defect or malfunction was caused by accident, neglect, unreasonable use, improper service or other causes not arising out of defects in material or workmanship.

THERE ARE NO WARRANTIES, EXPRESS OR IMPLIED, INCLUDING, BUT NOT LIMITED TO, THOSE OF MERCHANTABILITY OR FITNESS FOR A PARTICULAR PURPOSE, WHICH EXTEND BEYOND THE DESCRIPTION AND PERIODS SET FORTH HEREIN.

POLYSCIENCE'S SOLE OBLIGATION UNDER THIS WARRANTY IS LIMITED TO THE REPAIR OR REPLACEMENT OF A DEFECTIVE PRODUCT AND POLYSCIENCE SHALL NOT, IN ANY EVENT BE LIABLE FOR ANY INCIDENTAL OR CONSEQUENTIAL DAMAGES OF ANY KIND RESULTING FROM USE OR POSSESSION OF THE PRODUCT.

Some states do not allow (A) limitations on how long an implied warranty lasts, or (B) the exclusion or limitation of incidental or consequential damages, so the above limitations or exclusions may not apply to you. This warranty gives you specific rights, and you may have other rights which vary from state to state.



Be sure to activate your new PolyScience 300 Series Chamber Vacuum Sealer warranty at **[www.cuisinetechology.com](http://www.cuisinetechology.com)**

**PolyScience**  
**6600 W. Touhy Avenue**  
**Niles, IL 60714 USA**

Toll-free USA and Canada: (800) 229-7569  
Worldwide: +1 (847) 647-0611  
Email: [culinary@polyscience.com](mailto:culinary@polyscience.com)