



Mediterranean

SPRING / SUMMER 2023



#Design A14-b

Instructions

ES: Riñonera
EN: Bum bag
DE: Gürteltasche
IT: Marsupio
FR: Banane
NE: Heuptasje

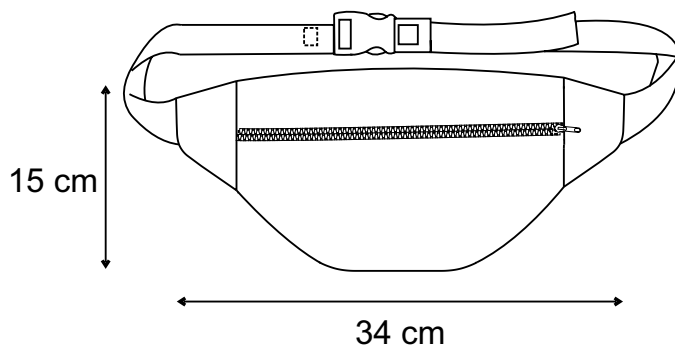

**Plano de corte / Cutting plan / Zuschneideplan
Cartamodello/ Plan de coupe / Knippatroom:**

Tejido 1 / Fabric 1 / Stoff 1 / Tessuto 1 / Tissu 1 / Stof 1

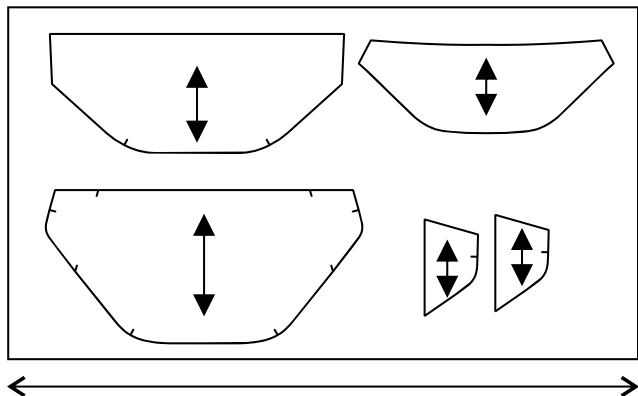

Tejido 2 / Fabric 2 / Stoff 2 / Tessuto 2 / Tissu 2 / Stof 2

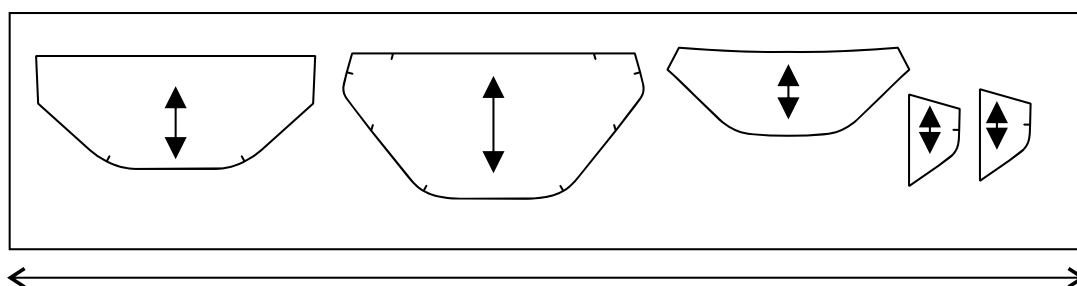

Materiales / Materials / Benötigtes Material:

ESP:

Cremallera 31 cm: 1 unidad
Cinta bolsera de 30mm: 110 cm;
Cierre hebilla de mochila de plástico: 1 unidad
Cinta bias: 150 cm

ENG:

12" (31 cm) zip: x 1 Bag tape
1 1/8" (30 mm) wide: 43 1/4" (110 cm)
Plastic backpack snap buckle: x 1
Bias tape: 59" (150 cm)

DE:

Reißverschluss, 31 cm lang: 1 Stück
Gurtband, 30 mm breit: 110 cm
Steckschließer aus Kunststoff: 1 Stück
Besatzstreifen: 150 cm

Materiale / Fournitures / Benodigd materiaal:

IT:

Cerniera 31 cm: 1 unità.
Nastro per borse di 30mm: 110 cm
Chiusura fibbia di plastica: 1 unità
Nastro sbieco: 150 cm

FR :

1 fermeture éclair de 31 cm
110 cm de lanière de 30 mm de large pour sac
1 boucle banane à coulisse
150 cm de biais

NL:

Rits 31 cm: 1 stuks.
Taslint van 30mm: 110 cm
Plastic gespsluiting voor rugzak: 1 stuks
Bieslint: 150 cm

Metros usados / Metres required / Benötigte Meter / Metri necessari / Métrage nécessaire / Gebruikte meters:

Diseño 1 / Design 1 / Muster 1 / Disegno 1 / Modèle 1 / Ontwerp 1:

Tejido 1 / Fabric 1 / Stoff 1 / Tessuto 1 / Tissu 1 / Stof 1: 40 cm 2095-3 Copper Cork
Tejido 2 / Fabric 2 / Stoff 2 / Tessuto 2 / Tissu 2 / Stof 2: 30 cm 2024-9 Recycled Canvas

Diseño 2 / Design 2 / Muster 2 / Disegno 2 / Modèle 2 / Ontwerp 2:

Tejido 1 / Fabric 1 / Stoff 1 / Tessuto 1 / Tissu 1 / Stof 1: 40 cm 2096-8 Tropical Leaves Corkk
Tejido 2 / Fabric 2 / Stoff 2 / Tessuto 2 / Tissu 2 / Stof 2: 30 cm 2024-9 Recycled Canvas

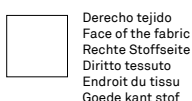
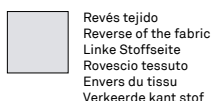

ESPAÑOL

Riñonera

1.

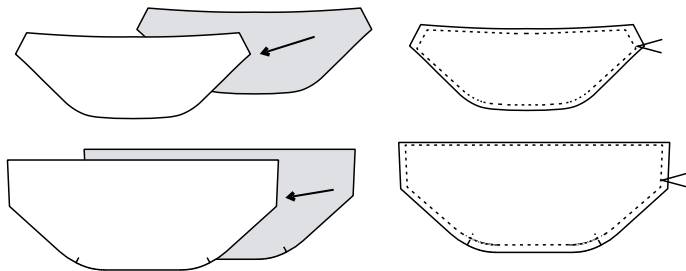

Forrar las piezas delanteras de la riñonera con las piezas de forro, revés con revés del tejido. Pasar una costura por todo el contorno.

2.

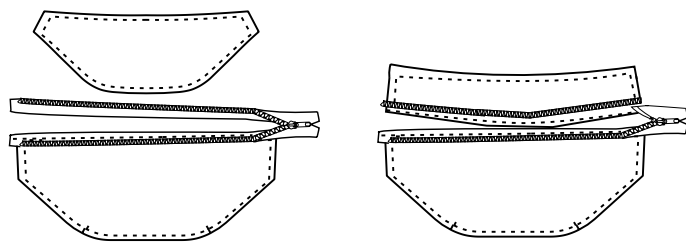

Montar la cremallera a las piezas delanteras, derecho de la cremallera con derecho del tejido.

3.

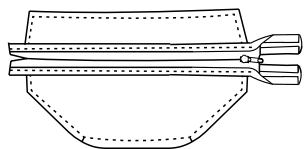

Coser un bias en la parte trasera de la cremallera para pulir la costura.

4.

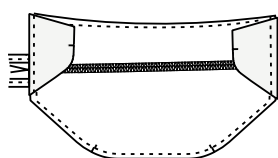

Coser las piezas laterales en el delantero exterior y el forro, derecho con derecho.

5.

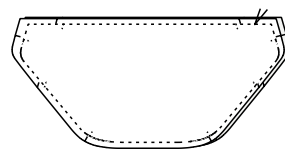

Forrar la piezas trasera de la riñonera con la pieza del forro, revés con revés del tejido. Pasar una costura por todo el contorno.

6.

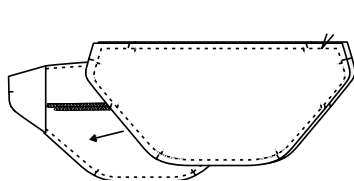

Encarar el tejido exterior de la pieza trasera con la delantera de la riñonera. Coser la parte superior e inferior, dejar los laterales sin coser. Coser un bias en la parte superior e inferior para pulir la costura.

7.

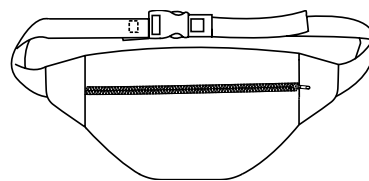

Montar la hebilla de la riñonera, cortar una tira de cinta de 35 cm y otra tira de 75 cm para la parte del regulador de la hebilla. Introducir la cinta en los laterales y coser desde el interior.

ENGLISH

Bum bag

1.

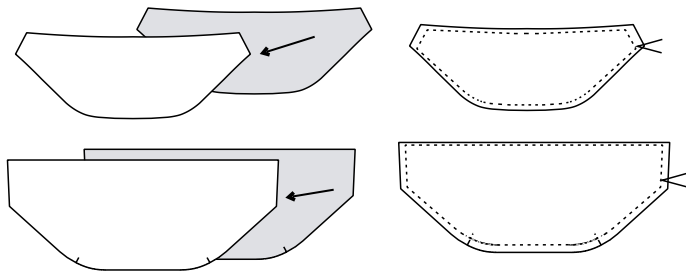

Match the front bum bag pieces to the lining pieces, with the wrong sides of the fabrics facing together. Sew around the edges.

2.

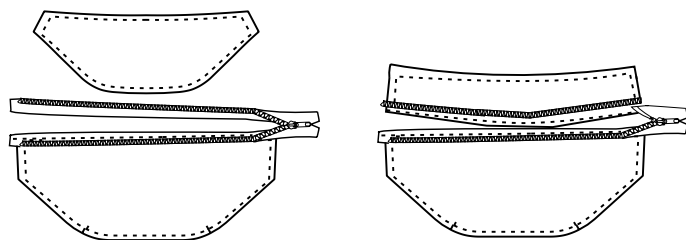

Insert the zip between the front pieces, with the right side of the zip facing the right side of the fabric.

3.

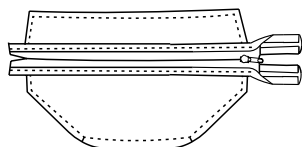

Sew a bias strip along the edges of the back of the zip to neaten the seams.

4.

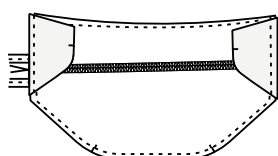

Sew the side pieces onto the exterior front piece and the lining, with the right sides of the fabrics facing together.

5.

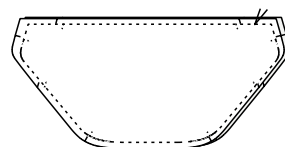

Line the back bum bag piece with the lining, with the wrong sides of the fabrics facing together. Sew around the edges.

6.

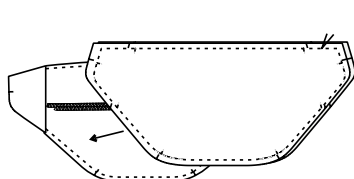

Match the exterior fabric of the back and front pieces together. Sew the upper and lower edges leaving the sides unsewn. Sew a bias tape finish along the upper and lower edge to neaten the seams.

7.

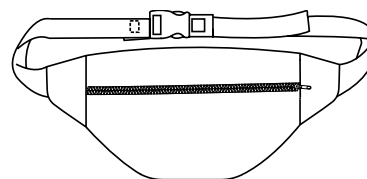

Attach the plastic snap buckle; cut one length of bag tape 13 3/4" (35 cm) long and another 29 1/2" (75 cm) long for the regulating part of the buckle. Insert the ends of the tape into the bum bag sides and sew in place from the inside.

DEUTSCH

Gürteltasche

1.

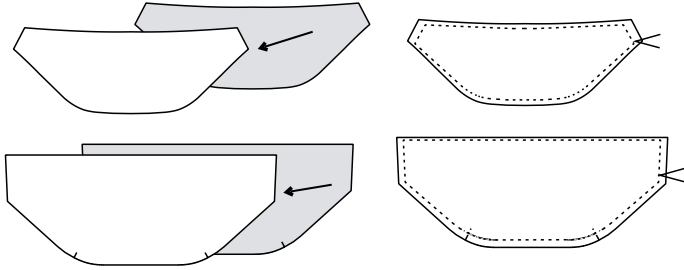

Die Außenstoffteile der Vorderseite der Gürteltasche rechts auf rechts auf die Futterteile legen und rundherum zusammennähen.

2.

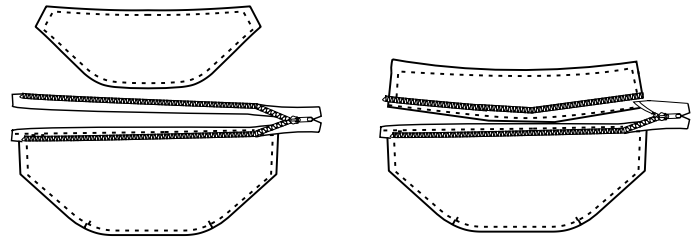

Den Reißverschluss rechts auf rechts in die Vorderteile einnähen.

3.

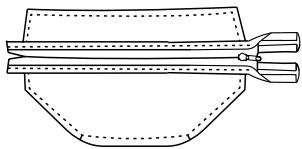

Einen Besatzstreifen auf die Rückseite des Reißverschlusses nähen, um die Naht zu versäubern.

4.

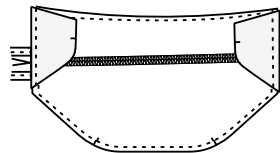

Die Seitenteile rechts auf rechts an die Vorderseite der Gürteltasche nähen.

5.

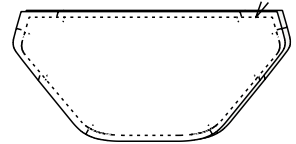

Die Außenstoffteile der Rückseite der Gürteltasche auf die Futterteile legen und rundherum zusammennähen.

6.

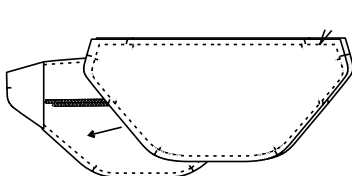

Die Außenstoffseiten der Vorderseite und der Rückseite der Gürteltasche aufeinanderlegen und den oberen und unteren Rand nähen. Die Seitenränder nicht nähen. Einen Besatzstreifen auf den oberen und unteren Rand nähen, um die Naht zu versäubern.

7.

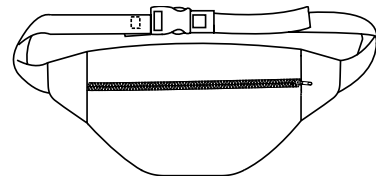

Für den Steckschließer einen 35 cm langen Gurtband-Streifen und einen 75 cm langen Gurtband-Streifen (für die Regulierungsseite des Steckschließers) abschneiden. Die Enden der Streifen durch den Steckschließer ziehen und von innen annähen.

1.

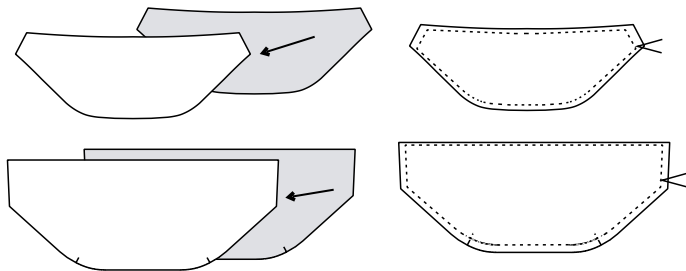

Foderare le parti del davanti del marsupio con quelle della fodera, rovescio contro rovescio. Cucire tutto attorno.

2.

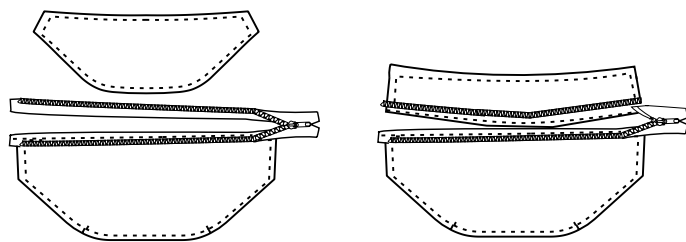

Cucire la cerniera sui davanti, con il diritto della cerniera sul diritto del tessuto.

3.

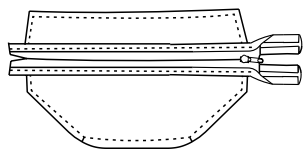

Cucire un nastro sbieco sulla parte posteriore della cerniera, per pulire la cucitura.

4.

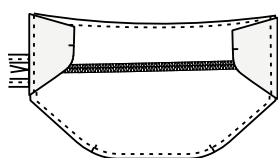

Cucire le parti laterali alla parte esterna del davanti e alla fodera, diritto contro diritto.

5.

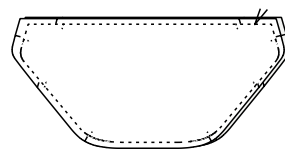

Foderare le parti del dietro del marsupio con la parte della fodera, rovescio contro rovescio. Cucire tutto attorno.

6.

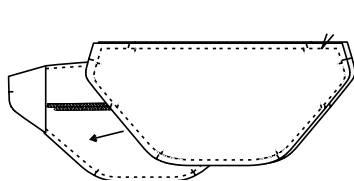

Sistemare il tessuto esterno del dietro su quello del davanti. Cucire la parte superiore e quella inferiore, lasciando scuciti i lati. Cucire un nastro sbieco sulla parte superiore e su quella inferiore per pulire la cucitura.

7.

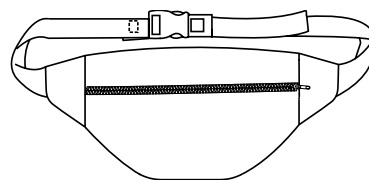

Attaccare la fibbia del marsupio, tagliare un nastro di 35 cm e uno di 75 cm per la parte della chiusura della fibbia. Attaccare il nastro sui lati e cucire dall'interno.

FRANÇAIS

Banane

1.

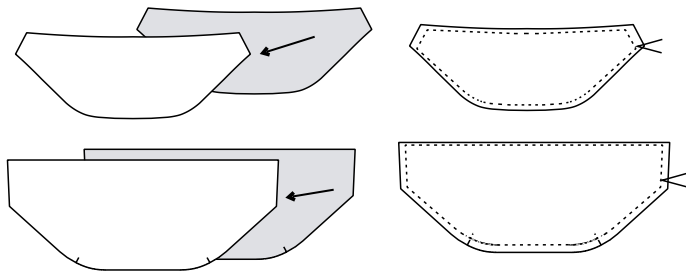

Doubler les morceaux avant de la banane, envers contre envers. Coudre le tissu principal et la doublure ensemble sur tout le pourtour.

2.

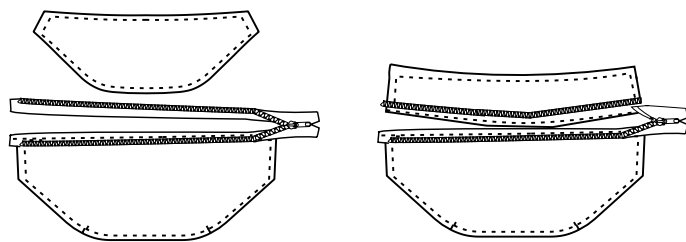

Monter la fermeture éclair sur l'avant, endroit contre endroit.

3.

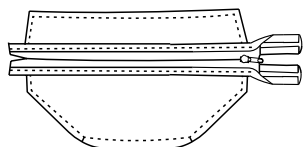

Coudre un biais sur l'envers de la fermeture pour obtenir des finitions parfaites.

4.

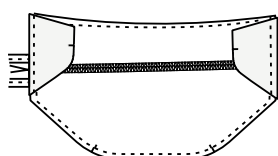

Coudre les morceaux latéraux sur l'extérieur du devant, endroit contre endroit.

5.

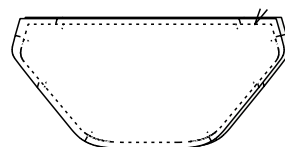

Doubler les morceaux arrière de la banane, envers contre envers. Coudre le tissu principal et la doublure ensemble sur tout le pourtour.

6.

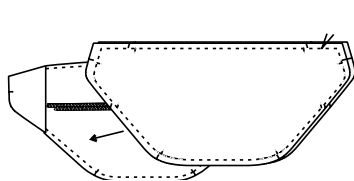

Placer les deux parties de la banane (avant et arrière) endroit contre endroit. Coudre le haut et le bas, en laissant les côtés non cousus. Coudre un biais sur les coutures pour obtenir des finitions parfaites.

7.

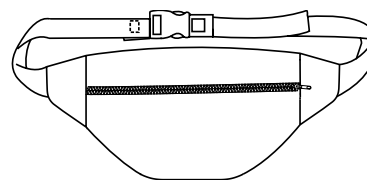

Monter la boucle de banane : couper un morceau de lanière de 35 cm et un autre de 75 cm qui passera dans la coulisse. Introduire la lanière dans les côtés et coudre sur l'envers.

NEDERLANDS

Heuptasje

1.

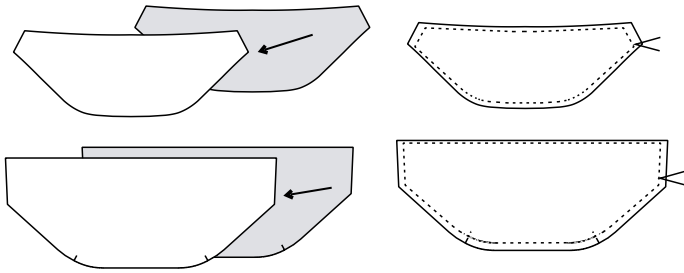

De delen van de voorkanten van het heuptasje voeren met de delen van de voering, verkeerde kant aan verkeerde kant van de stof. Naai een naad rondom de gehele omtrek.

2.

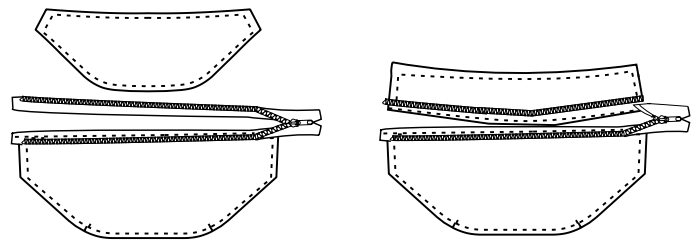

Monteer de rits aan de delen van de voorkanten, goede kant van de rits aan goede kant van de stof.

3.

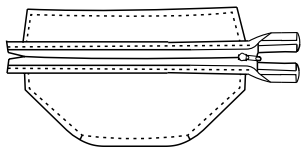

Naai een biaslint aan het deel van de achterkant van de rits voor het afwerken van de naad.

4.

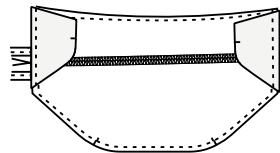

Naai de delen van de zijkanten aan de buitenkant van de voorkant en de voering, goede kant aan goede kant.

5.

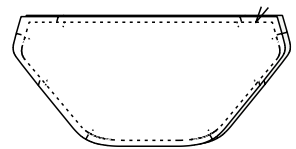

Voer de delen van de achterkant van het heuptasje met het deel van de voering, verkeerde kant aan verkeerde kant van de stof. Naai een naad rondom de gehele omtrek.

6.

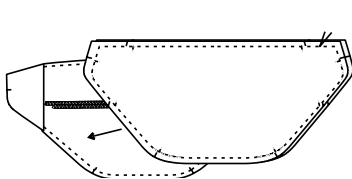

Leg de stof van de buitenkant van het deel van de achterkant tegenover de voorkant van het heuptasje. Naai het gedeelte aan de bovenkant en onderkant, hierbij de zijkanten niet vastnaaien. Naai een biaslint over het gedeelte aan de bovenkant en onderkant voor het afwerken van de naad.

7.

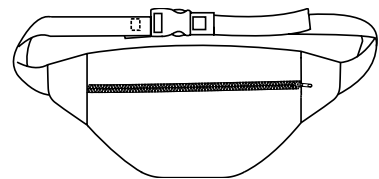

Bevestig de gesp van het heuptasje, knip een lint van 35 cm lengte en knip nog een lint van 75 cm lengte voor het gedeelte van de regulator van de gesp. Introduceer het lint aan de zijkanten en naaien vanaf de binnenkant.

Sewing Pattern:

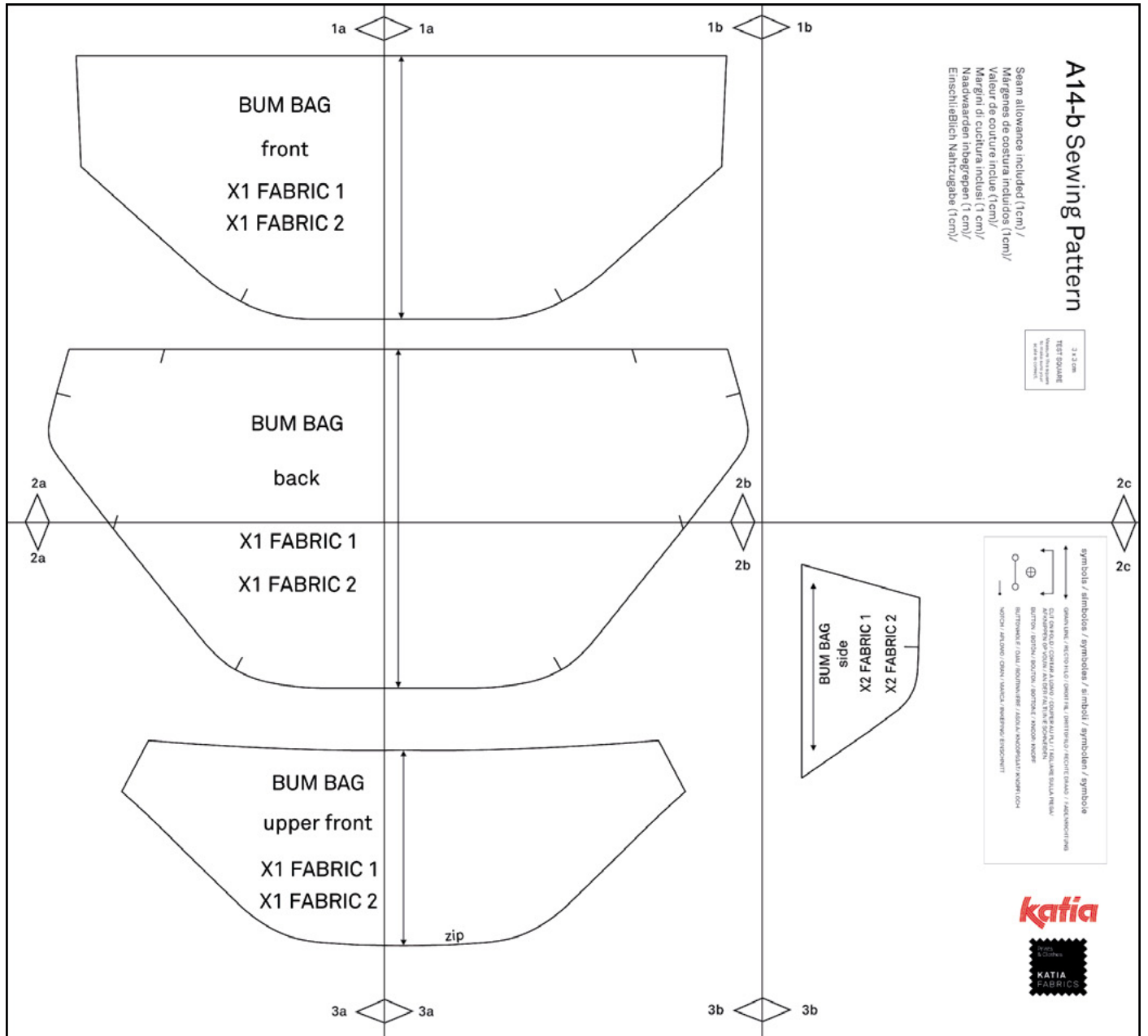



1a

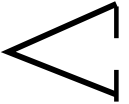

BUM BAG

front

X1 FABRIC 1

X1 FABRIC 2

BUM BAG

back

2a



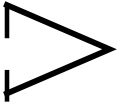

1a

1b

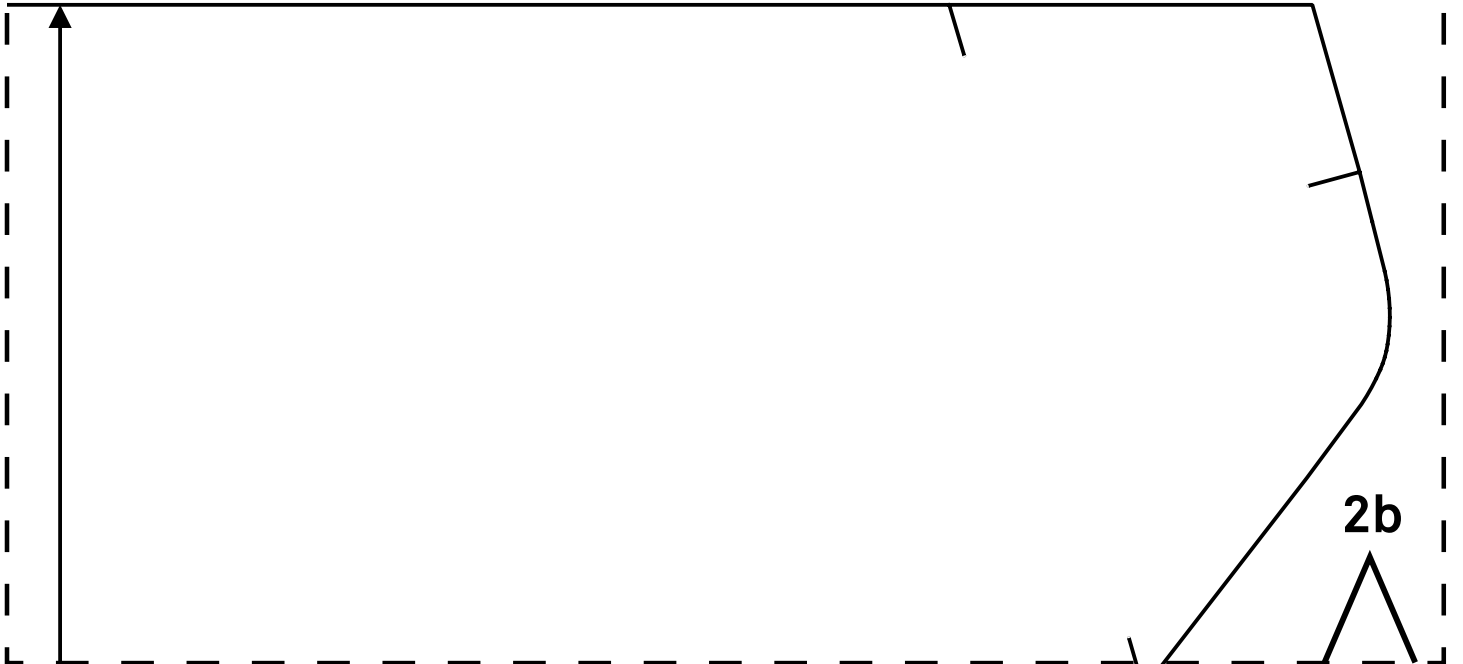
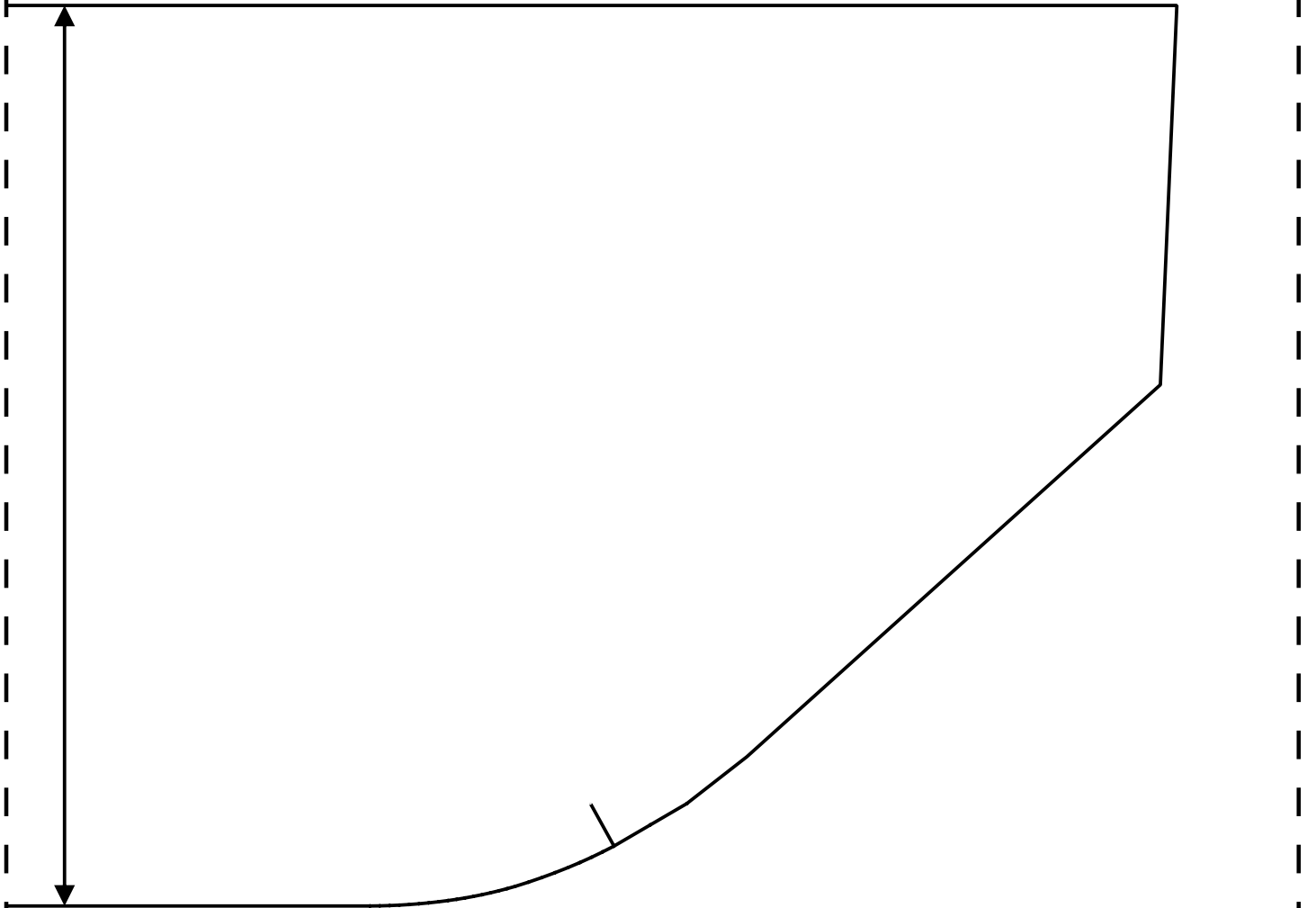
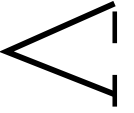

2b

A14-b Sewing Pattern

Seam allowance included (1cm) /
Màrgenes de costura incluidos (1cm) /
Valeur de couture incluse (1cm) /
Margini di cucitura inclusi (1 cm) /
Naadwaarden inbegrepen (1 cm) /
EinschlieBlich Nahtzugabe (1cm) /

3 x 3 cm
TEST SQUARE
Measure this square
to make sure your
scale is correct.

2c



1b

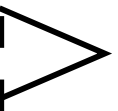

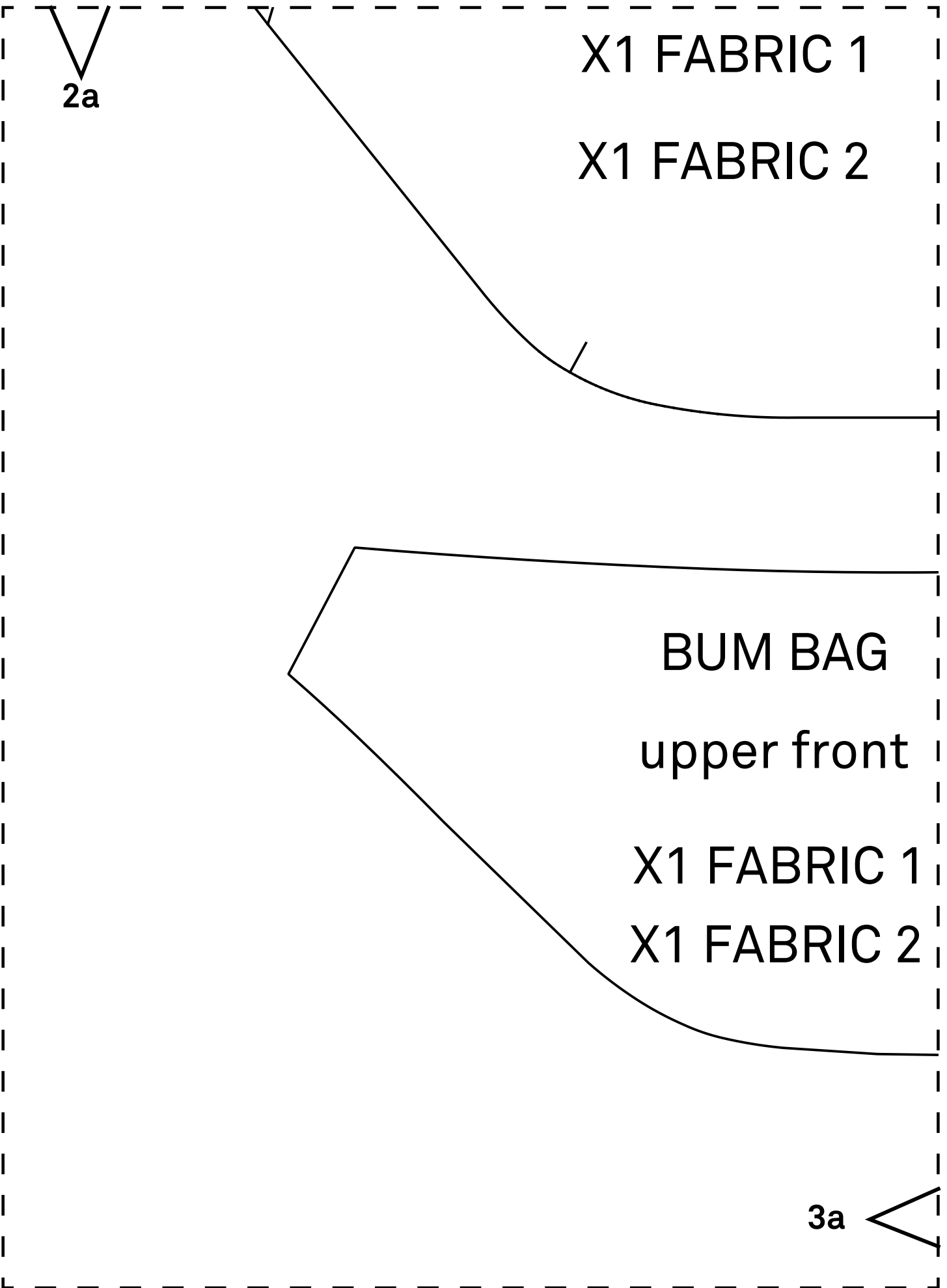

X1 FABRIC 1

X1 FABRIC 2

2a

BUM BAG

upper front

X1 FABRIC 1

X1 FABRIC 2

3a

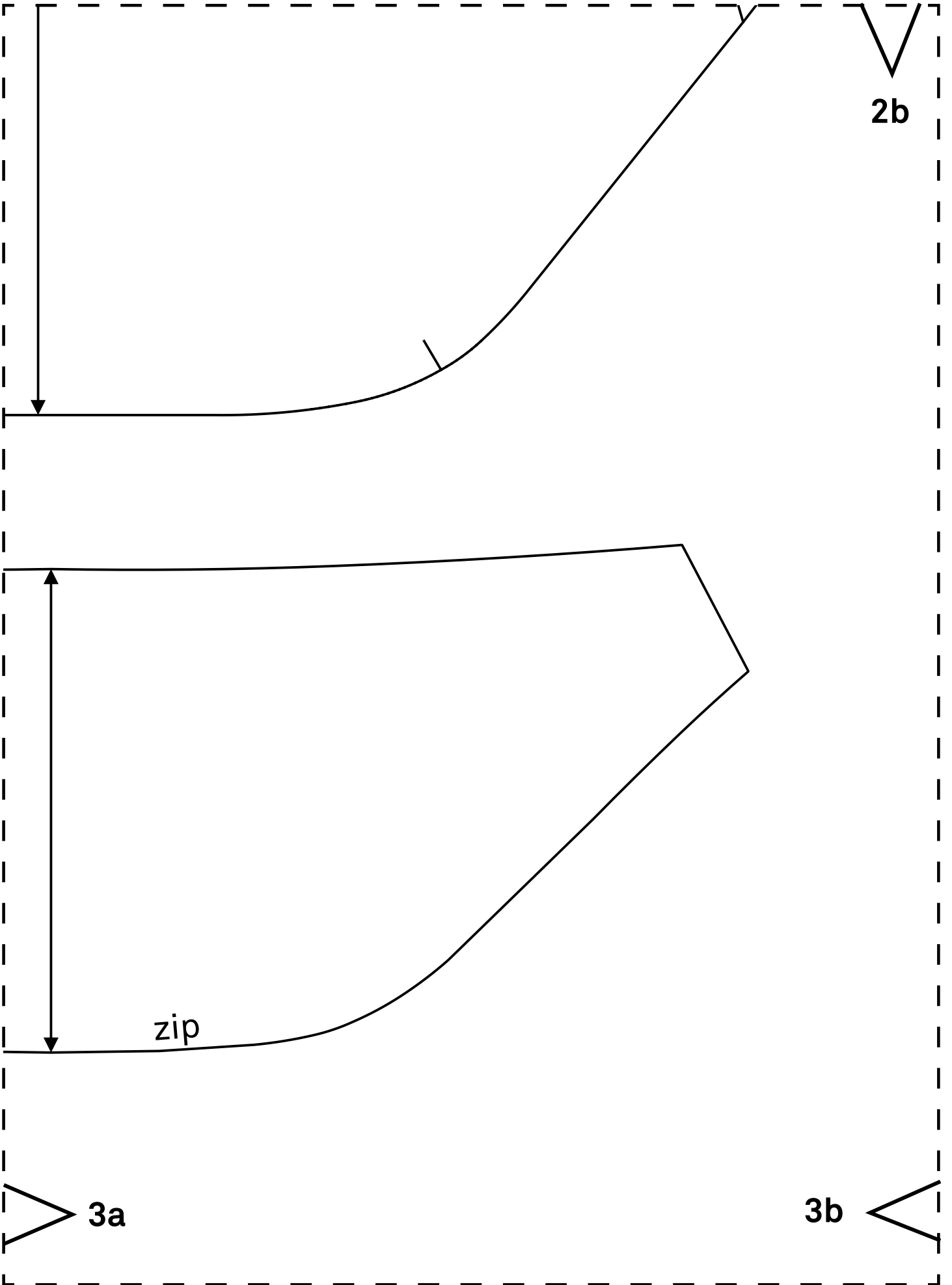

2b

zip

3a

3b



2c

symbols / símbolos / symboles / simboli / symbolen / symbole

GRAIN LINE / RECTO HILO / DROIT FIL / DRITTOFILO / RECHTE DRAAD / FADENRICHTUNG

CUT ON FOLD / CORTAR A LOMO / COUPER AU PLI / TAGLIARE SULLA PIEGA /
AFKNIPPEN OP VOUW / AN DER FALTLINIE SCHNEIDEN

BUTTON / BOTÓN / BOUTON / BOTTONE / KNOOP / KNOPF

BUTTONHOLE / OJAL / BOUTINIÈRE / ASOLA / KNOOPSGAT / KNOPFLOCH

NOTCH / APLOMO / GRAN / MARCA / INKEPING / EINSCHNITT

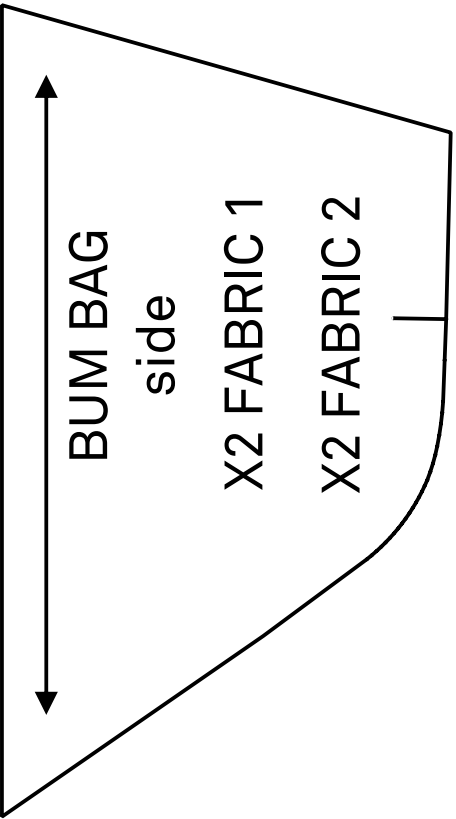

Katia

Prints
& Clothes

KATIA
FABRICS

3b