

- For continuous level measurement of liquids (even if polluted), mash and paste materials in open or closed vessels, sumps, open channels, drains, etc.
- Variants of level meter with adjustment by two buttons, or by magnetic pen
- Xi version for usage in explosive areas
- State indication by two LEDs
- Current output (4 ... 20 mA), voltage output (0 ... 10 V) or RS-485 Modbus output
- Wide choice of electric connection via connectors, cable glands or protective conductor
- Reception of reflected ultrasonic signal from level can be improved using horn adapter



The ULM® ultrasonic level meters are compact measurement devices containing an ultrasonic transmitter and an electronic module. Using an transmitter, level meters transmit the series of ultrasonic pulses that spread towards the level surface. The transmitter recuperates reflected acoustic waves that are subsequently processed in the electronic module. Based on the period during which the individual pulses spread towards the level and back, this period is averaged by the electronics that performs temperature compensation and subsequently a conversion to an output current 4 -20 mA, voltage 0 - 10 V or output RS-485 Modbus.

Thanks to the contactless measuring principle ultrasonic level meters are suitable for continuous measurement or limit level sensing of liquids, waste water, sludge, suspensions, adhesives, resins in various open and closed vessels, sumps, open channels and drains. Use for organic solvents or substances, which contain organic solvents, should be consulted with the manufacturer. Usability for level measurement of solid materials is limited, there is a shorter measuring range. We recommend using the level meter for such a medium to consult with the manufacturer. Setting is carried out either using two buttons or a magnetic pen or by remote setting in case of Modbus RTU output. The device is equipped with optical indication of its state (RUN) and the setting process (STATE). It is manufactured in designs for normal (N) and explosive atmospheres (Xi).

VARIANTS OF SENSORS

- ULM-53_-01-_ **measurement range 0.1 m to 1 m**, all-plastic design, source of PVDF (polyvinylidene fluoride), mechanical connection with thread G ¾.
- ULM-53_-02-_ **measurement range 0.20 m to 2 m**, all-plastic design, source of PVDF, mechanical connection with thread G 1".
- ULM-53_-06-_ **measurement range 0.20 m to 6 m**, all-plastic design, source of PVDF, mechanical connection with thread G 1 ½".
- ULM-53_-10-_ **measurement range 0.4 m to 10 m**, all-plastic case, source of PVDF, mechanical connection with thread G 2 ¼".
- ULM-53_-20-_ **measurement range 0.5 m to 20 m**, all-plastic case, source of PVDF, mechanical connection with flange of aluminium alloy.

DIMENSIONAL DRAWINGS

ULM-53_-01

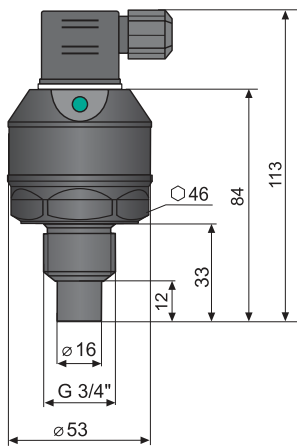

ULM-53_-02

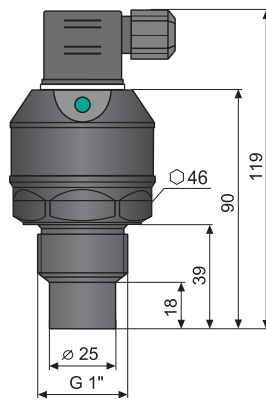

ULM-53_-06

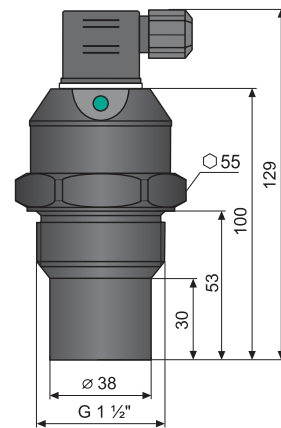

ULM-53_-10

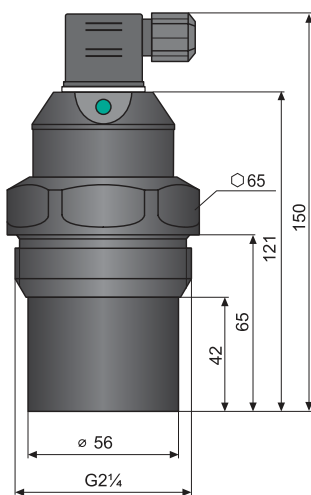

ULM-53_-20

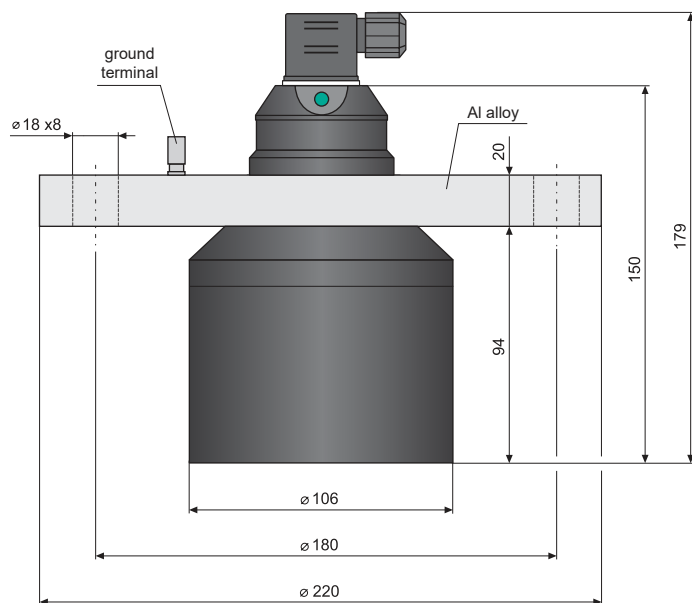

Variant "G" with connector ISO

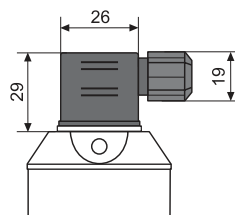

Variant "C" with connector M12

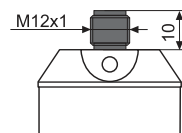

Variant "B" with short cable terminal PG11

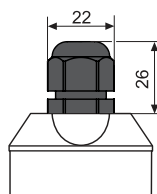

Variant "H" with outlet for protective conductor

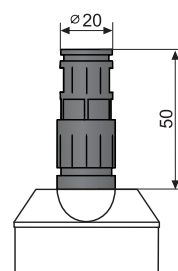

TECHNICAL SPECIFICATIONS

Measuring range ¹⁾	ULM-53_-01-_	0,1 ... 1 m	
	ULM-53_-02-_	0,2 ... 2 m	
	ULM-53_-06-_	0,2 ... 6 m	
	ULM-53_-10-_	0,4 ... 10 m	
	ULM-53_-20-_	0,5 ... 20 m	
Supply voltage	ULM-53N-_-_-_-	18 ... 36 V DC	
	ULM-53Xi-_-_-_-I	18 ... 30 V DC	
Current supply	ULM-53N(Xi)-_-_-_-I	4 ... 20 mA / max. 22 mA	
	ULM-53N-_-_-_-U	max. 12 mA	
	ULM-53N-_-_-_-M	max. 20 mA	
Current output	ULM-53_-_-_-_-I	4 ... 20 mA (limit values 3.9 ... 20.5 mA)	
Voltage output	ULM-53N-_-_-_-U	0 ... 10 V (limit values 0 ... 10.2 V)	
Modbus output	ULM-53N-_-_-_-M	Modbus RTU protocol	
Resolution		< 1 mm	
Accuracy (within the total range)	ULM-53_-01_ in area 0,1-0,2 m / 0,2-1,0 m	0,3 % / 0,2 %	
	ULM-53_-02_-; -06	0,15 %	
	ULM-53_-10_-; -20	0,2 %	
Temperature error		max. 0,04% / K	
Beamwidth (-3 dB)	ULM-53_-01_-; -02_-; -10_-	10°	
	ULM-53_-06_-	14°	
	ULM-53_-20_-	12°	
Ambient temperature range	ULM-53_-01_-; -02_-; -06_-	-30 ... +70°C	
	ULM-53_-10_-; -20_-	-30 ... +60°C	
Measuring period	ULM-53_-01_-; -02_-	0,5 s	
	ULM-53_-06_-; -10_-	1,2 s	
	ULM-53_-20_-	5,0 s	
	ULM-53_-_-_-_-M	adjustable via Modbus RTU	
Averaging (can be modified according to agreement)	ULM-53_-_-_-_- ULM-53_-_-_-_-M	4 measurement ³⁾ adjustable via Modbus RTU	
Short time temperature stress resistance		+90°C / 1 hod.	
Max. operation overpressure (on transmission surface)		0,1 MPa	
Max. internal values ²⁾ (for the Xi version only)		U _i =30 V DC; I _i =132 mA; P _i =0,99 W; C _i =370 nF; L _i =0,9 mH	
Failure indication	echo failure – basic mode	3,75 mA / 0 V / Modbus RTU	
	echo failure – inverse mode	22 mA / 10,5 V / Modbus RTU	
	level in dead zone ⁴⁾ – basic mode	22 mA / 10,5 V / Modbus RTU	
	level in dead zone ⁴⁾ – inverse mode	3,75 mA / 0 V / Modbus RTU	
Protection class	ULM-53_-_-_-_- T	IP67	
	ULM-53_-_-_-_- G-M, L		
	ULM-53_-_-_-_- C-M, L	IP67 ⁵⁾	
	ULM-53_-_-_-_- B-M, L		
ULM-53_-_-_-_- H-M, L	IP68		
Recommended cable		PVC 2 x 0,75 mm ² (3 x 0,5 mm ² ; 2 x 2 0,25 mm ²)	
Maximal current output load resistance		at U = 24 V DC	R _{max} = 270 Ω
		at U = 22 V DC	R _{max} = 180 Ω
		at U = 20 V DC	R _{max} = 90 Ω
Minimal voltage output load resistance		R _{min} > 1 kΩ	
Delay between supply power rise time and first measurement	ULM-53_-01_-; -02_-; -06_-	5 s	
	ULM-53_-10_-; -20_-	9 s	
Process connection	ULM-53_-01-_	thread G 3/4"	
	ULM-53_-02-_	thread G 1"	
	ULM-53_-06-_	thread G 1 1/2"	
	ULM-53_-10-_	thread G 2 1/4"	
	ULM-53_-20-_	aluminium alloy flange	
Weight	ULM-53_-01-_	0,20 kg	
	ULM-53_-02-_	0,20 kg	
	ULM-53_-06-_	0,25 kg	
	ULM-53_-10-_	0,65 kg	
	ULM-53_-20-_	2,80 kg	

¹⁾ In case the level of bulk-solid materials is measured, the measurement range is reduced.

²⁾ Allowed pressure range in the zone 0: 80 ... 110 kPa.

³⁾ From the last six measurements are taken out extreme values MAX and MIN, then the remaining four measurement was performed arithmetic average.

⁴⁾ Dead zone = blind zone = blocking zone.

⁵⁾ Protection class IP68 can be achieved when a special connector is used.

WORKING AREAS AND AREA CLASSIFICATION (under EN 60079-10 and EN 60079-14)

UL_-53N-_-_-	Basic performance for non-explosive atmospheres.
ULM-53Xi-01-I ULM-53Xi-02-I ULM-53Xi-06-I	Intrinsically safe explosion-proof performance for use in hazardous areas (explosive gas atmospheres) Ⓜ II 1/2G Ex ia IIB T5 Ga/Gb with intrinsically safe supply units ¹⁾ , whole level meter zone 1, front head part 0.
ULM-53Xi-10-_-I	Intrinsically safe explosion-proof performance for use in hazardous areas (explosive gas atmospheres) Ⓜ II 1/2G Ex ia IIA T5 Ga/Gb with intrinsically safe supply units ¹⁾ , whole level meter zone 1, front head part 0.
ULM-53Xi-20-_-I	Intrinsically safe explosion-proof performance for use in hazardous areas (explosive gas atmospheres) Ⓜ II 2G Ex ia IIA T5 Gb with intrinsically safe supply units ¹⁾ , whole level meter zone 1.

¹⁾ Intrinsically safe isolating repeater (e.g. Dinel IRU-420).

MATERIALS

sensor part	type variant	standard material
Housing	all	plastic PP
Electro-acoustic transducer	all	plastic PVDF
Flange	UL_-53_-20	lacquered aluminum alloy
Cable gland	all	plastic PA

RANGE OF APPLICATION

Thanks to the proximity principle employed, the devices are suitable for continuous measurement of the level of liquids, waste water, sludge, suspensions, adhesives, resins in various open and closed vessels, sumps, open channels and drains.

Applicability for measuring the surface level of loose materials is limited, the range of measurement is shorter there. We recommend that the suitability of the level meter for measuring bulk-solid materials is consulted with the manufacturer.

ELECTRICAL CONNECTION

Connection through ISO connector

The ULM level meter with a G type cable gland are connected to processing (display) units by means of a cable with an outer diameter of 6 to 8 mm (recommended wire cross-section 0.5 to 0.75 mm²), via a detachable ISO connector with inner screw terminals, which is part of the delivery. The connection diagram and the inner view of the connector are shown in Figures on the right. Non-detachable connector IP67 with PVC cable 5 m long can be supplied as an extra option.

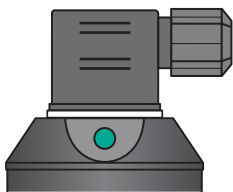

View of the connector ISO

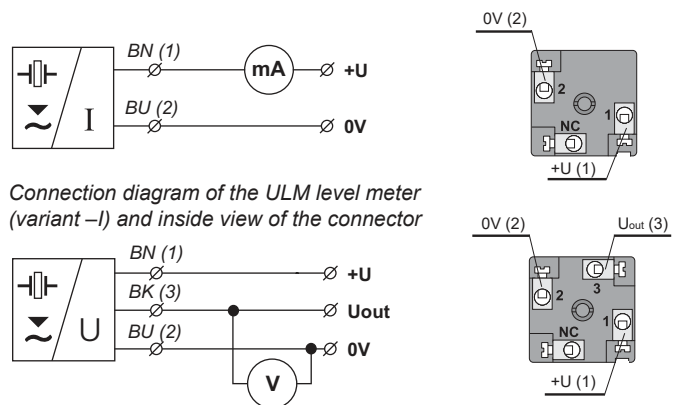

Connection diagram of the ULM level meter (variant -I) and inside view of the connector

Connection diagram of the ULM level meter (variant -U) and inside view of the connector

Connection through M12 connector

The ULM level meter with a C type cable gland are connected to processing (display) units by means of a cable with an outer diameter of 4 to 6 mm (recommended wire cross-section 0.5 to 0.75 mm²), via a connector socket with a moulded cable (2 or 5 m long) or via a detachable connector socket without a cable (see accessories), the connector is not basic part of the sensor. In this case connect the cable to the inner socket pins under figures on the right.

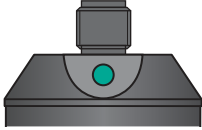

View of the connector M12

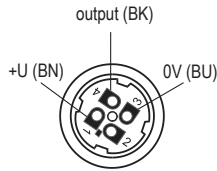

Inside view of the connector socket

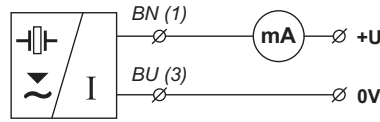

Connection diagram of the ULM level meter (variant -I) and inside view of the connector

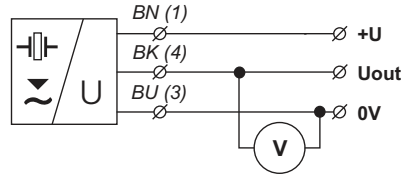
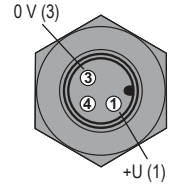

Connection diagram of the ULM level meter (variant -U) and inside view of the connector

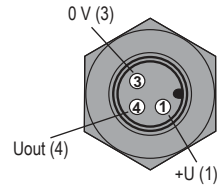

Connection via PG 11 gland or gland for protective hoses

The ULM level meter with a B or H type cable gland are connected to processing (display) units by means of a fixed PVC cable 5 m long. PG 11 (B) or plastic bushings with a thread for protective hoses (H) can be used as a cable gland. Connection diagrams are shown in Figures on the right.

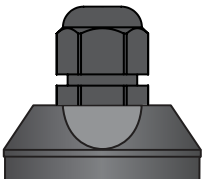

View of the cable gland PG11

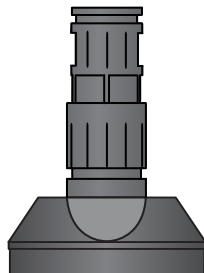

View of the cable gland for protective hose

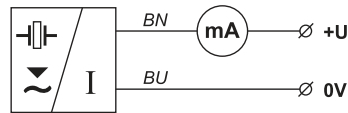

Connection diagram of the ULM level meter (variant -I) and inside view of the connector

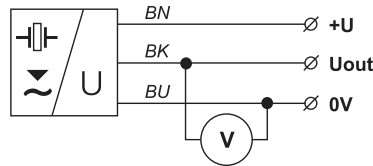

Connection diagram of the ULM level meter (variant -U) and inside view of the connector

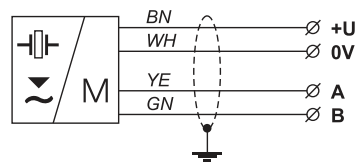

Connection diagram of the level meter with an RS-485 output (variant -M)

- Legend:**
- BK** – black
 - BN** – brown
 - BU** – blue
 - WH** – white
 - YE** – yellow
 - GN** – green



Wiring operations shall only be carried out without voltage!

Taking into account the potential occurrence of electrostatic discharge on non-conducting parts of the level meter, it is necessary to ground the flange of level meters ULM-53Xi-20-F, located in an explosive atmosphere, using a ground terminal!



It is also necessary to design and take measures to reduce the effects of static electricity to a safe level in the wiring.

Installation in explosive atmospheres needs to be carried out in compliance with EN 60079-14 (Electrical installations for explosive gaseous atmospheres – Part 14: Electrical installations in dangerous areas other than mining) and possibly also in compliance with other standards relating to the area concerned.



The supply source should be preferably designed as a stabilized source of safe voltage 18 V to 36 V DC (max. 30 VDC for version Xi), which is part of the downstream processing or display system.

In case of strong ambient electromagnetic disturbance, parallel run of the input cable with the power line or its length exceeding 30 m, we recommend using a shielded cable.

SETTINGS

Device type with setting using buttons

The measuring range is setup by means of two buttons "DOWN" and "UP". The "DOWN" button is used to enter to the setting mode (setting the 4 mA or 0V limit) and to decrease the output current or voltage. The "UP" button as an opposite function (setting the 20 mA or 10 V limit and increasing the output current or voltage). Values are confirmed by simultaneous pressing of both buttons for about 1 sec. The setting process is indicated by yellow "STATE" LED indicator.

For detailed information please read at the instructions manual.

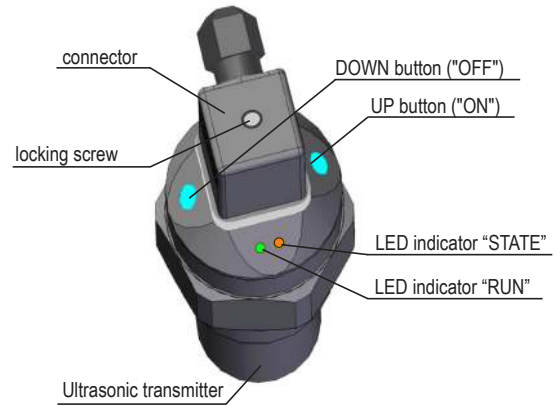

Key parts of the measuring device
(version with buttons)

Device type with setting using a magnetic pen

The measuring range is setup by touching of the magnetic pen to sensitive spots "EMPTY" and "FULL". The "EMPTY" spot is used to enter to the setting mode (setting the 4 mA or 0V limit) and to decrease the output current or voltage. The "FULL" spot as an opposite function (setting the 20 mA or 10 V limit and increasing the output current or voltage). Values are confirmed by touching of the magnetic pen to the sensitive spot for about 3 sec. The setting process is indicated by yellow "STATE" LED indicator.

For detailed information please read at the instructions manual.

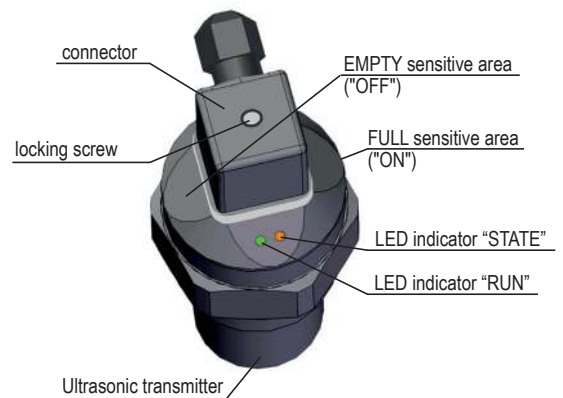

Key parts of the measuring device
(version with Hall probes)

FUNCTION AND STATUS INDICATION

LED indicator	Colour	Function
"RUN"	green	<p>short flashing (repeated depending on the measurement interval approx. 1 ... 2 s) - correct function, receipt of signal (echo) reflected from the measured surface</p> <p>fast flashing – the measured surface is in the dead zone of the level meter or the ultrasound transducer is dirty</p> <p>off – the level meter is not capable of receiving the echo. Incorrect installation or malfunction</p>
"STATE"	orange	<p>Setting indication</p> <ul style="list-style-type: none"> • slow flashing – 4 mA (0V) threshold setting indication • fast flashing – 20 mA (10V) threshold setting indication • 3 short flashes – setting confirmation <p>variant "M" with Modbus communications</p> <ul style="list-style-type: none"> • fast flashing – communication under way on line RS-485

ORDER CODE

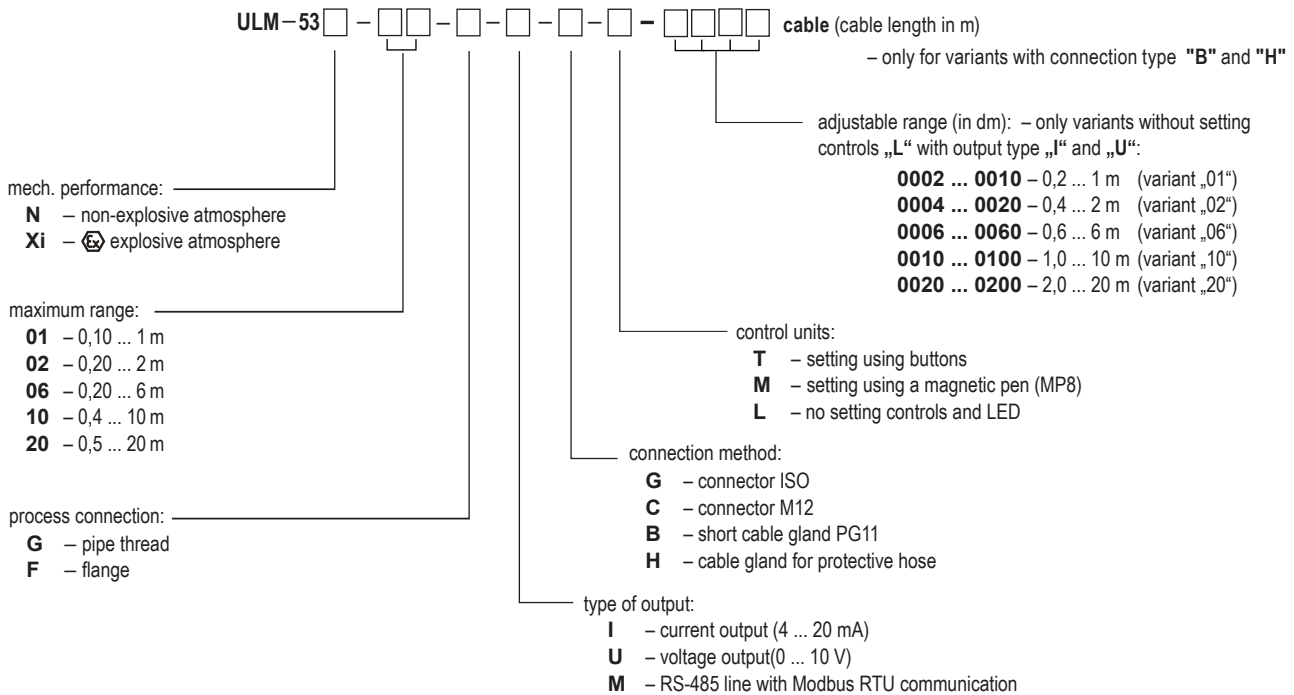

CORRECT SPECIFICATION EXAMPLES

ULM-53N-02-G-I-G-T

(**N**) Performance for non-explosive areas; (**02**) maximum range 0,2 ... 2 m; (**G**) process connection pipe thread; (**I**) current output (4 ... 20 mA); (**G**) connection method ISO connector; (**T**) set-up elements buttons.

ULM-53N-20-F-U-H-M cable 5m

(**N**) Performance for non-explosive areas; (**20**) maximum range 0,5 ... 20 m; (**F**) process connection flange; (**U**) voltage output (0 ... 10 V); (**H**) connection method cable gland for protective hose; (**M**) set-up elements magnetic pen (MP8).

ULM-53Xi-06-G-I-B-M cable 5m

(**Xi**) Explosive environments performance; (**06**) maximum range 0,2 ... 6 m; (**G**) process connection pipe thread; (**I**) current output (4 ... 20 mA); (**B**) connection method short cable gland PG11; (**M**) set-up elements magnetic pen (MP8).

ULM-53N-10-G-M-C-L

(**N**) Performance for non-explosive areas; (**10**) maximum range 0,4...10m; (**G**) process connection pipe thread; (**M**) RS-485 line with Modbus RTU communication; (**C**) connector M12; (**L**) no setting controls and LED.

ACCESSORIES

standard (included in the level meter price)

- 1x seal (for UL_-53_- 01; 02; 06, 10)
- 1x connector with IP67 coverage (for versions with an ISO connector)
- 1x magnetic pen MP-8 (for device type adjusted with a magnetic pen)
- free-to-download programme Basic Scada Level (for the Modbus version)

optional - for a surcharge (see catalogue sheet of accessories)

- plastic fastening nuts PUM-G1, PUM-G1,5 a PUM-G2,25
- shorn adapter ST-G1, ST-G1,5 and ST-G2,25
- stainless steel or standard steel welding flanges NN-G1, ON-G1, NN-G1,5 a ON-G1,5
- socket ELWIK 4012 K PG7 or ELKA 4012 K PG7
- connector with IP67 coverage (type GAN-DADE 7A) with 5m cable (for current output and ISO type connector)
- connector with IP67 coverage (type GAN-DAEE 7A) with 5m cable (for voltage output and ISO type connector)
- protective hose (for version with "H" type terminal)
- converter URC-485 (for the Modbus version)

SAFETY, PROTECTIONS, COMPATIBILITY AND EXPLOSION PROOF

Level meter ULM-53 is equipped with protection against electric shock on the electrode, reverse polarity, output current overload, short circuit and against current overload on output.

Protection against dangerous contact is provided by low safety voltage according to 33 2000-4-41. Electromagnetic compatibility is provided by conformity with standards EN 55011/B, EN 61326-1 and EN 61000-4-2 to 6.

Explosion proof ULM-53Xi is provided by conformity with standards EN 60079-0:2007, EN 60079-11:2007, EN 60079-26:2007.

Explosion proof ULM-53Xi is verified FTZÚ – AO 210 Ostrava – Radvanice: FTZÚ 09 ATEX 0119X.

A declaration of conformity was issued for this device in the wording of Act No. 90/2016 Coll., as amended. Supplied electrical equipment matches the requirements of valid European directives for safety and electromagnetic compatibility.

Special conditions for safe use of variants ULM-53Xi

The device is designed for connection to the isolating repeater IRU-420. When the other approved supply unit is used, whose output parameters satisfy above mentioned output parameters, it is necessary to have a galvanic separation or, if supply unit without galvanic separation is used (Zener barriers), it is necessary provide potential equalization between sensor and point of barrier earthing.

For application in zone 0 the present explosive atmospheres - mixture of air with flammable gases, vapour or mists must comply:

- 20°C < Ta < + 60°C; 0.8 bar < p < 1.1 bar.

The device must be installed in such a way, to prevent mechanical damage of sensor face.

Maximum input parameters:

Ui = 30 V; li= 132 mA; Pi = 0.99 W; Ci = 370 nF; Li = 0.9 mH

PACKINGS, SHIPPING AND STORAGE

The ULM-53 device is supplied packaged in a cardboard box that protects it against mechanical damage.

When handling and during transport, it is necessary to prevent impacts and falls.

The ULM-53 electrical device must be stored in dry enclosed areas with humidity up to 85%, free of aggressive vapours at temperatures between -20°C and 60°C, and must be protected against the effects of weather.

version: 11/2018