

The logo consists of the word "iotty" in a lowercase, blue, sans-serif font, centered within a white circle. The background of the entire image is a solid blue color.

iotty

Model: OSWFR
ID: OSW2FR

MOS2FR01

Deutsch

Technische Daten	4
Wichtige Hinweise	5
Fehlerbehebung	5
Übersicht über das Gerät	6
Installationsanweisungen	7
App	11
Integrationen	12

Français

Données techniques	13
Notes Importantes	14
Troubleshooting	14
Aperçu du dispositif	15
Instructions de montage	16
Appli	20
Integrations	21

English

Technical specifications	22
Important notes	23
Troubleshooting	23
Device overview	24
Installation steps	25
App	29
Integrations	30

Español

Especificaciones técnicas	31
Notas importantes	32
Resolución de problemas	32
Descripción general del dispositivo	33
Pasos para la instalación	34
Aplicación	38
Integraciones	39

Technische Daten

OFR PLUS Smarte Steckdose

Modell: OSWFR

ID: OSW2FR

Eingang: 230 Vac

Frequenz: 50Hz

Max. 16 A

Umgebungstemperatur: 25°C

Betriebstemperatur: 0°C bis 40°C

Funktioniert nur mit **2.4GHz band**

Frequenzbereich: 2412-2472MHz

Maximale HF-Ausgangsleistung des Produkts:
17.29 dBm

Informationen zur HF-Exposition: Die maximal zulässige Exposition (MPE) wird auf der Grundlage eines Abstands von $d = 20$ cm zwischen dem Gerät und dem menschlichen Körper berechnet. Um die Einhaltung der HF-

Expositionsanforderungen zu gewährleisten, sollte ein Abstand von 20 cm zwischen dem Gerät und dem Menschen eingehalten werden.

Wichtige Hinweise

Sicherheitsvorkehrung

Installieren Sie das Gerät in Übereinstimmung mit allen nationalen und lokalen Vorschriften.

Wenden Sie sich an einen Elektrofachmann, wenn Sie mit elektrischen Arbeiten nicht vertraut oder nicht fachkundig sind oder wenn die Verkabelung in Ihrer Verteilung von den Abbildungen abweicht.

Nur zur Verwendung in Innenräumen und an trockenen Orten.

Vorsichtsmaßnahme bei der Installation

Neutralleiter erforderlich.

Fehlerbehebung

Versuchen Sie im Falle eines Netzwerkfehlers die folgenden Schritte der Reihe nach:

- Starten Sie das Modem neu und warten Sie ein paar Minuten, bis alle Geräte verbunden sind

ODER, sollte das Problem fortbestehen:

- Entfernen Sie die Touch-Glasplatte und drücken Sie die Reset-Taste am Schalter

ODER, sollte das Problem fortbestehen:

- Entfernen Sie das Glas und drücken Sie die AP-Taste am Gerät. Wiederholen Sie die Geräteregistrierung.

Gewährleistung

Informationen zur Gewährleistung erhalten Sie unter link.iotty.com/warranty

Übersicht über das Gerät

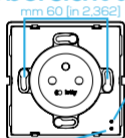

AP-Taste

Macht das WLAN des Geräts wieder sichtbar. Nützlich für die Neuregistrierung des Geräts in der App, die Aktualisierung der Internet-Zugangsdaten oder das Ausschalten des WLAN des Geräts.

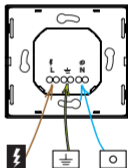

Reset-Taste

Startet das Gerät neu. Alle Einstellungen bleiben gespeichert.

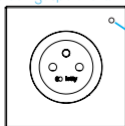

AN/AUS Schalter

Zum einfachen Ein- und Ausschalten der Steckdose muss das angeschlossene Gerät nicht ausgesteckt werden.

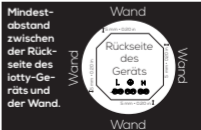

Installationsanweisungen

1

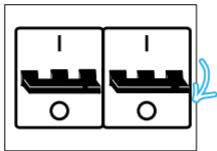

Schalten Sie das Schütz der zu ersetzenden Steckdose aus.

2

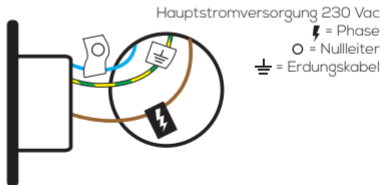

Entfernen Sie die alte Steckdose und kennzeichnen Sie die Drähte. Denken Sie daran, dass Sie den Nullleiter benötigen, um Steckdose zu installieren.

3

Hauptstromversorgung 230 Vac

⚡ = Phase oder Leitung

○ = Nullleiter

⏏ = Erdungskabel

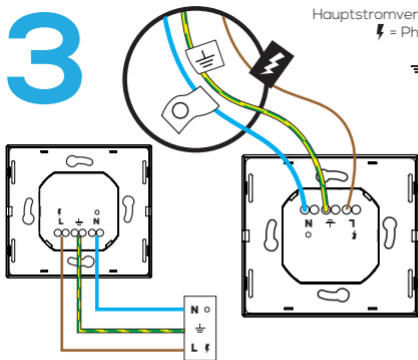

Das iotty-Steckdose verdrahten

Führen Sie das Stromversorgungskabel in die Klemme L ein. Führen Sie den Draht des Nullleiters in die Klemme N ein. Führen Sie den Draht der Erdung in die Klemme \perp ein. Vergleichen Sie die Verdrahtung mit dem Schaltplan in der Abbildung, um zu prüfen, ob alles korrekt ist.

4

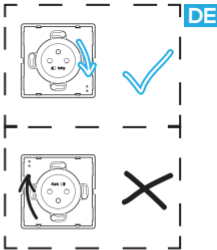
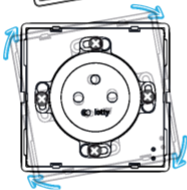
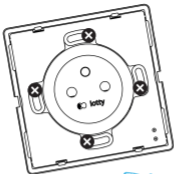

Die iotty-Steckdose festschrauben

Drücken Sie alle Drähte in die Wandschalterdose (verwenden Sie dazu nicht die Rückseite des Schalters). Setzen Sie iotty-Steckdose in die Wandschalterdose ein und schrauben Sie sie fest. Positionieren Sie die Steckdose so, dass sich die AP- und Reset-Tasten rechts befinden.

5

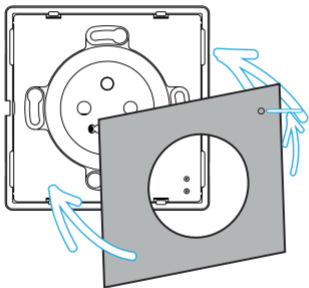
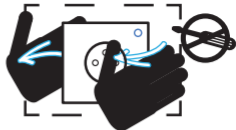

Die Glasplatte anbringen

Setzen Sie das Glas so ein, dass sich der kleine Kreis oben befindet. Befestigen Sie das Glas an Ihrem iotty-Steckdose

6

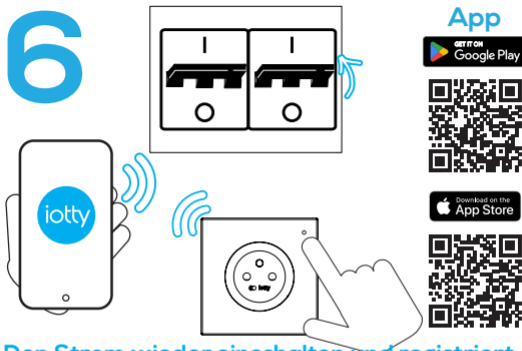

App

DE



Den Strom wieder einschalten und registriert das Gerät

Schalten Sie das Schütz der Steckdose ein. Überprüfen Sie, ob die Verdrahtung korrekt ausgeführt wurde, indem Sie ein elektrisches Gerät, z. B. ein Ladegerät, in die Steckdose stecken. Perfekt, jetzt ist die Installation erfolgreich abgeschlossen und Sie können mit der Registrierung des Geräts fortfahren.

iotty Geräte sind mit folgenden **Integrationen** kompatibel:



Wenn Sie weitere Informationen benötigen, können Sie uns unter support@iotty.com kontaktieren oder  besuchen Sie unseren FAQ-Bereich



Données techniques

OFR PLUS Prise intelligente

Modèle: OSWFR

ID: OSW2FR

Entrée: 230 Vac

Fréquence: 50Hz

Max 16 A

Température ambiante: 25°C

Température de fonctionnement: de 0°C à 40°C

Fonctionne uniquement avec la bande **2.4GHz**
Wi-Fi

Gamme de fréquences: 2412-2472MHz

Puissance de sortie RF maximale du produit:
17.29 dBm

Informations sur l'exposition aux RF: Le niveau d'exposition maximale admissible (MPE) est calculé sur la base d'une distance de $d = 20$ cm entre l'appareil et le corps

humain. Pour maintenir la conformité aux exigences d'exposition aux RF, une distance de séparation de 20 cm entre l'appareil et l'humain doit être maintenue.

Notes Importantes

Mesure de sécurité

Faites l'installation conformément à tous les normes nationales et locales.

Faites venir un électricien professionnel si vous n'êtes pas familier ou pas à l'aise avec les travaux électriques, ou si le câblage de votre boîtier électrique est différent des schémas.

Pour usage intérieur et endroit sec uniquement.

Précaution d'installation

Fil neutre requis.

Troubleshooting

En cas d'erreur réseau, essayez ces étapes dans l'ordre:

- Redémarrez votre routeur

OU, if the problem persists,

- Retirez la façade de verre et appuyez sur le bouton de réinitialisation de la prise

OU, if the problem persists,

- Retirez la façade de verre et appuyez sur le bouton AP de la prise.

FR

Garantie

Pour des informations sur la garantie, allez sur link.iotty.com/warranty

Aperçu du dispositif

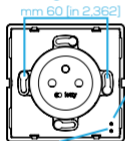

Bouton AP

Rend la WiFi du dispositif à nouveau visible. Utile pour refaire l'enregistrement du dispositif sur l'Appli, mettre à jour les identifiants pour le réseau Internet ou éteindre la WiFi de la plaque.

Bouton de redémarrage

Redémarrer le dispositif, tous les paramètres restent enregistrés.

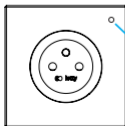

Bouton ON/OFF

Pour allumer et éteindre facilement la prise de courant, pas besoin de débrancher l'appareil électroménager.

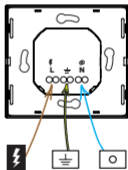

5 mm (0.20 in)
Distance minimum entre l'arrière du dispositif iotty et le mur.



Instructions de montage

1

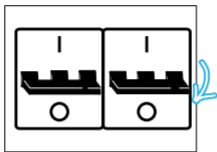

Éteignez le contacteur de la prise que vous remplacez.

2

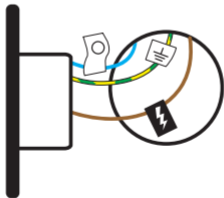

Retirez votre ancienne prise et étiquetez les câbles.

3

Alimentation principale 230 Vac

⚡ = Phase ou ligne

○ = Neutre

⏚ = Terre

FR

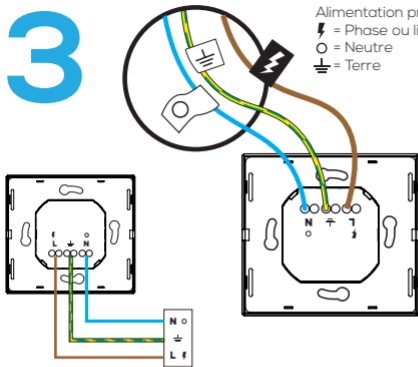

Câblez la plaque iotty

Insérez le câble du courant dans la borne L. Insérez le câble du neutre dans la borne N. Insérez le câble de la terre dans la borne ⏚ . Confrontez le câblage avec le schéma électrique de l'image pour vérifier que tout soit correct.

4

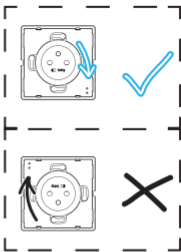
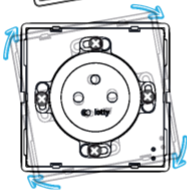
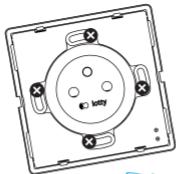

Vissez la prise iotty

Poussez tous les câbles dans le boîtier mural (ne pas le faire avec l'arrière de la prise). Insérez la prise iotty dans le boîtier mural et vissez-le. Placez la prise de sorte que les boutons AP et reset se trouvent sur la droite.

5

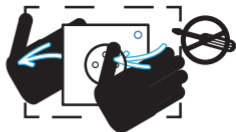

FR

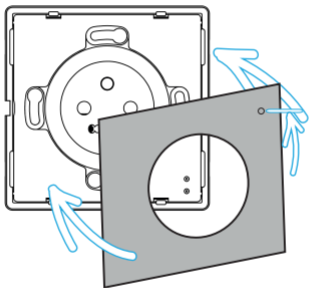

Fixez le verre

Placez le verre de sorte que le petit cercle soit positionné en haut.

6

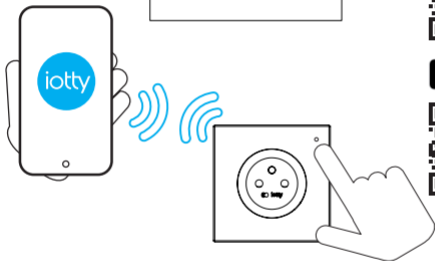

Appli



Rébranchez le courant et enregistrer le dispositif

Allumez le contacteur de la prise. Contrôlez que le câblage ait été correctement réalisé en introduisant un appareil électrique dans la prise, par exemple un chargeur. Parfait, l'installation a été réalisée avec succès et vous pouvez enregistrer le dispositif.

Les appareils iotty sont compatibles avec les **integrations** suivantes:

FR



Si vous avez besoin de plus d'informations, vous pouvez nous contacter à support@iotty.com ou visitez notre Section FAQ



Technical specifications

OFR PLUS Smart Outlet

Model: OSWFR

ID: OSW2FR

Input: 230 Vac

Frequency: 50Hz

Max 16 A per RL

Ambient temperature: 25°C

Operating temperature: from 0°C to 40°C

Only works with **2.4GHz Wi-Fi band**

Frequency range: 2412-2472MHz

Maximum RF output power of the product:
17.29 dBm

RF exposure information: The Maximum Permissible Exposure (MPE) level is calculated based on a distance of d=20 cm between the device and the human body. To maintain

compliance with the RF exposure requirement, a separation distance of 20 cm between the device and the human should be maintained.

Important notes

Safety Precaution

Incorrect installation is dangerous or illegal. Install in accordance with all national and local codes.

Hire a professional electrician if you are not familiar or not comfortable with electrical work, or if the wiring in your electrical box looks different from the pictures.

For indoor use and dry location only.

Installation Precaution

Neutral wire required.

Troubleshooting

In case of network error, try these steps in order:

- Restart the router and wait a few minutes to allow all devices to reconnect

OR, if the problem persists,

- Remove the faceplate and push the Reset button on the device

OR, if the problem persists,

- Remove the faceplate and push the AP button on the device. Repeat device registration

Warranty

For warranty information visit us at link.iotty.com/warranty

Device overview

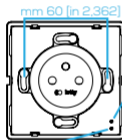

AP button

It makes the iotty Wi-Fi visible again. Useful to re-register the device on the app, update the Wi-Fi credentials, or turn off the device Wi-Fi.

Reset button

It restarts the device, all settings remain saved.

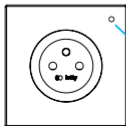
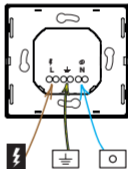

ON-OFF switch

To easily switch on and off the power of the outlet no need of unplugging the household appliance.

5 mm (0.20 in) minimal distance between the back of iotty device and the wall.

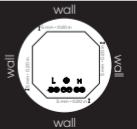

Installation steps

1

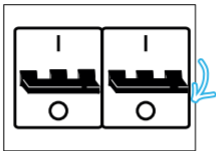

Turn off the power at the circuit breaker for the outlet you are replacing.

2

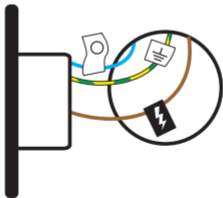

Remove your old outlet and label your wires. Remember that you must have neutral wire.

3

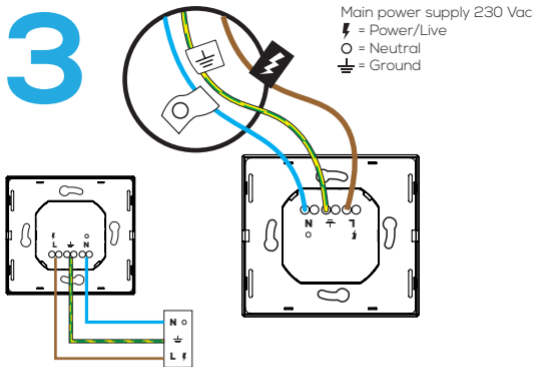

Wire the iotty plate

Insert the power wire into terminal L. Insert the neutral wire into terminal N. Insert the ground wire into terminal ⏏. Compare the wiring with the electrical scheme in the picture to be sure everything is in place.

4

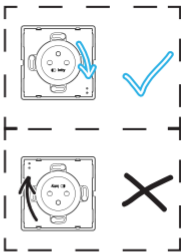
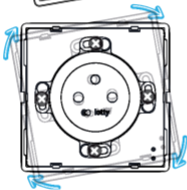
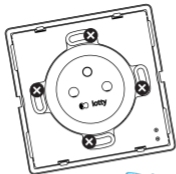

Screw the iotty outlet in

Push all the wires back into the wall box (do not push the wires using the back of the outlet). Insert the device in the wall box and screw it in. Position the outlet so that the AP and reset buttons are located on the right.

5

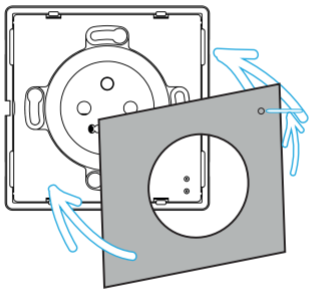
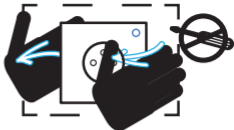

Attach the glass faceplate

Attach the faceplate so that the little circle is located at the top.

6

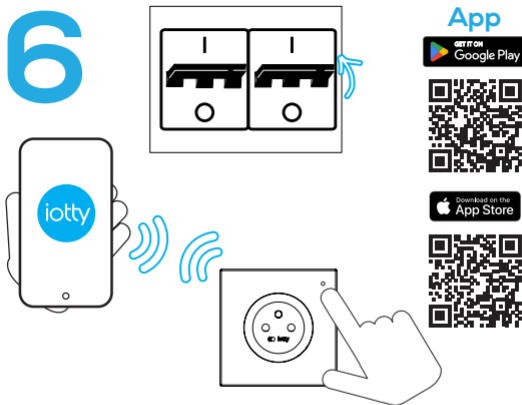

EN

Turn on the power and register device

Turn on the power at the circuit breaker. Check if the wiring was made correctly by tapping on the glass to turn on and off the outlet. Now the installation is complete and you can proceed to register the device.

iotty devices are compatible with the following integrations



If you need more information you can contact us at support@iotty.com or visit our FAQ section



Especificaciones técnicas

OFR PLUS Enchufe Inteligente

Modelo: OSWFR

ID: OSW2FR

Entrada: 230 Vac

Frecuencia: 50Hz

Máx 16 A

Temperatura ambiente: 25°C

Temperatura de funcionamiento: de 0°C a 40°C

Solo funciona con **banda Wi-Fi de 2.4 GHz**

Banda de frecuencia: 2412-2472MHz

Potencia máxima de salida de RF del producto:
17.29 dBm

Información sobre la exposición a RF: el nivel máximo de exposición permitido se calcula sobre la base de una distancia de 20 cm entre el dispositivo y el cuerpo humano. Para

garantizar el cumplimiento de la normativa sobre exposición a RF, debe mantenerse una distancia de 20 cm entre el dispositivo y el cuerpo humano.

Notas importantes

Instrucciones de seguridad

La instalación incorrecta puede llegar a ser peligrosa o, incluso, ilegal según qué caso. Instalar dentro del marco legal de todas las leyes nacionales y locales.

Contrata un electricista profesional si no estás familiarizado o no te sientes cómodo manejando instalaciones eléctricas; o, en caso de que tu instalación sea diferente a aquella mostrada en las instrucciones.

Para uso exclusivo dentro del hogar y en lugares poco húmedos.

Precauciones de Instalación

Se requiere un cable neutro.

Resolución de problemas

En caso de un error con la red, intenta realizar:

- Reinicie el router y espere unos minutos para permitir que todos los dispositivos se vuelvan a conectar.

O, si el problema persiste,

- Retira el cristal y presiona el pulsador de Restablecimiento del dispositivo

O, si el problema persiste,

- Retira el cristal y presiona el pulsador AP del dispositivo. Repite el registro del dispositivo.

Garantía

Para más información acerca de la garantía de este producto, consulte link.iotty.com/warranty

ES

Descripción general del dispositivo

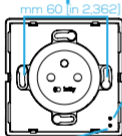

Botón AP

Hace que iotty Wi-Fi sea de nuevo visible. Util para volver a registrar el dispositivo en la app, actualizar las credenciales de Wi-Fi o apagar la Wi-Fi del dispositivo.

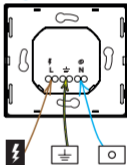

Botón de reinicio

Reinicia el dispositivo, todas las configuraciones permanecen guardadas

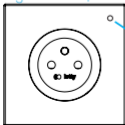

Pulsador de encendido/apagado

Para encender y apagar fácilmente el enchufe, no es necesario desenchufar el aparato.



Pasos para la instalación

1

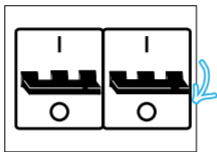

Apaga el contactor del enchufe que estás sustituyendo.

2

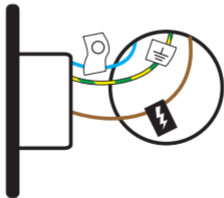

Retira el viejo enchufe y pon una etiqueta en los cables.

3

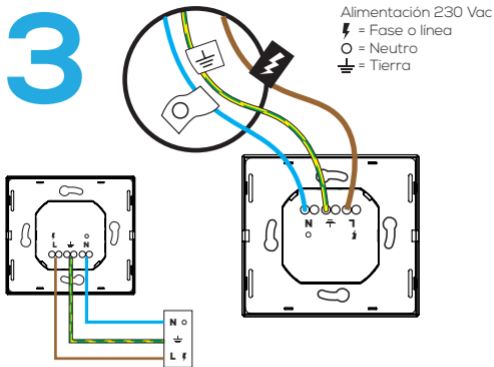

ES

Realiza el cableado de la placa iotty

Inserta el cable de la corriente en el terminal L.
Inserta el cable de neutro en el terminal N. Inserta el cable de tierra en el terminal ⏏. Compara el cableado con el diagrama de cableado de la imagen para comprobar que todo es correcto.

4

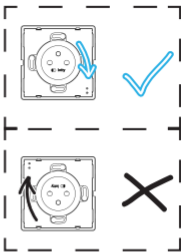
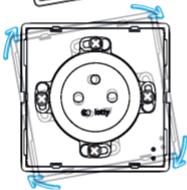
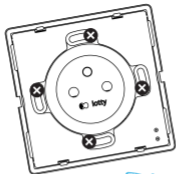

Enrosca el enchufe iotty

Introduce todos los cables en la caja de pared (no lo hagas con la parte trasera del enchufe). Introduce el dispositivo en la caja de pared y atorníllalo. Coloca el enchufe de forma que los botones AP y de reinicio queden a la derecha.

5

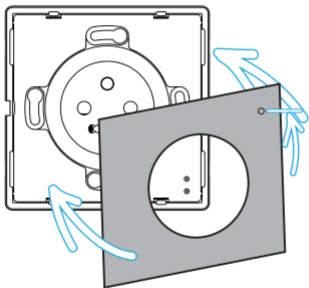
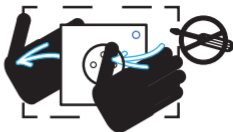

ES

Coloca el cristal

Coloca el cristal de forma que el círculo pequeño se sitúe en la parte inferior. Fija el cristal.

6

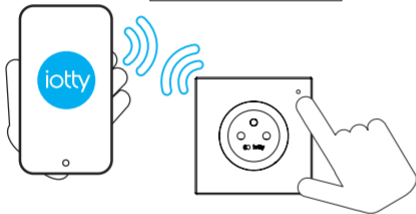
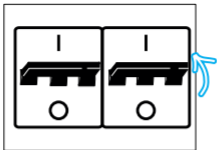

Aplicación



Conectar la electricidad y registra el dispositivo

Enciende el contactor del enchufe. Comprueba si el cableado se ha realizado correctamente conectando un aparato eléctrico al enchufe, por ejemplo, un cargador. Perfecto, ahora la instalación se ha realizado correctamente, puedes proceder a registrar el dispositivo.

Los dispositivos iotty son compatibles con las siguientes **integraciones**



ES

Si necesitas más información, puedes ponerte en contacto con nosotros en support@iotty.com o visitar nuestra sección de preguntas frecuentes:



iotty devices are compatible with the following integrations



If you need more information you can contact us at support@iotty.com or visit our FAQ section

