

VYPER

ASSEMBLY GUIDE

LOW PRO

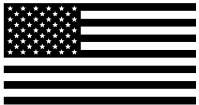

WARNING

Safety & Warnings

The VYPER CHAIR complies with all legally prescribed safety rules and regulations. Inappropriate use may cause damage to the product and injury or death to persons.

It is crucial to read the operation manual prior to using the VYPER CHAIR. It provides you with important information about safe and proper assembly, use and maintenance of the VYPER CHAIR.

Children should never use this VYPER CHAIR unless closely supervised by an adult.

Do not allow horseplay on or around the VYPER CHAIR.

SERIOUS OR FATAL INJURY CAN OCCUR FROM THE VYPER CHAIR FROM TIPPING OVER OR FALLING OFF OF THE VYPER CHAIR.

ACCORDINGLY:

Keep weight centered when using the VYPER CHAIR.

Only use VYPER CHAIR on a flat level surface, free of debris.

Keep one or both feet on the ground at all times when sitting on the VYPER CHAIR.

Never stand on the VYPER CHAIR.

Never allow more than one person on the VYPER CHAIR.

DO NOT USE THE VYPER CHAIR IF IT APPEARS DAMAGED OR BROKEN.

WARNING: To avoid the danger of suffocation, keep this plastic bag away from babies and children. Do not use this bag in cribs, beds, carriages or playpens. This bag is not a toy.

Read all instructions before assembly and use of VYPER CHAIR. Failure to comply with and observe all assembly, safety, operating instructions and warnings regarding the use of the VYPER CHAIR may result in serious bodily injury or death.

This includes strictly following all assembly instructions in the order in which they appear.

Assembling any VYPER CHAIR in an order other than that set out in the instructions increases the risk of product damage or injury or death to individuals.

Never attempt to sit on the VYPER CHAIR until it is fully assembled and all the fasteners are tightened in accordance with the assembly instructions. Failure to comply with this warning can lead to product damage and injury or death to individuals.

Do not attempt to repair any broken or defective parts or assemble using any parts that are damaged or defective. Please contact manufacturer immediately at: sales@VYPERindustrial.com

Never use substitute parts when assembling the VYPER CHAIR. Please contact manufacturer immediately if replacement parts are needed at VYPER CHAIR.



VYPER

VYPER was founded by the Rusch Family, a family that spent countless hours in the garage, starting one project after another. After years of torture using cheap chairs and hundreds of falls, Chris Rusch (known for being a master in metal shaping), designed & built the first ever VYPER Chair.

The VYPER Chair is strategically designed to prevent tipping over while rolling, provides relieving back support, improved sitting posture and increase comfort while using the highest quality American-made materials.

With their passion for the garage industry, Dayne and Dylan (the brothers) took over VYPER years ago with the determination to launch the highest quality products in any industry under the VYPER Brand while continuing to provide jobs to the American people.

TOOLS REQUIRED FOR ASSEMBLY

1/2" WRENCH AND/OR SOCKET | 3/4" WRENCH AND/OR SOCKET

x2



or x2



x2



or x2



3/8" WRENCH AND/OR SOCKET

x1



or x1



***POWER TOOLS NOT RECOMMENDED!**

STEP 1

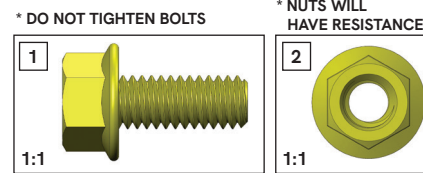
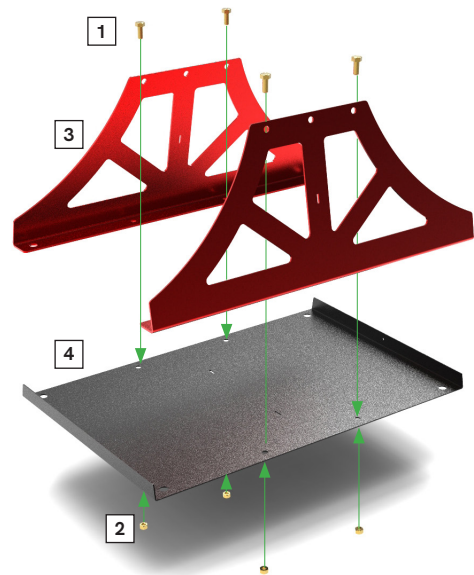
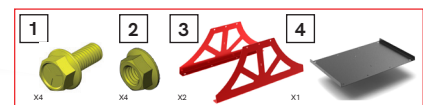

STEP 2

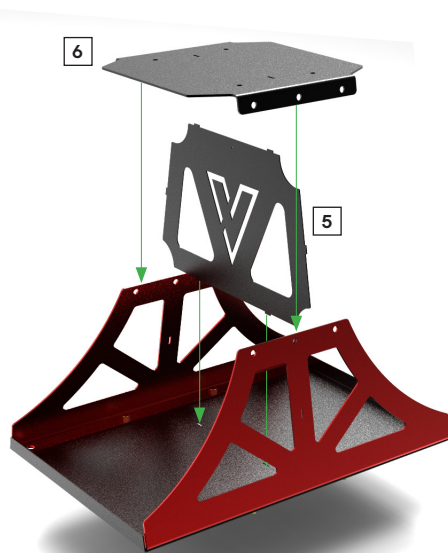
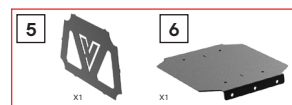

STEP 3

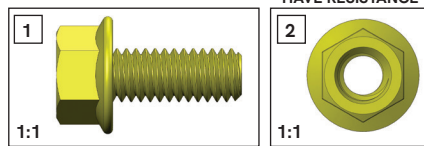
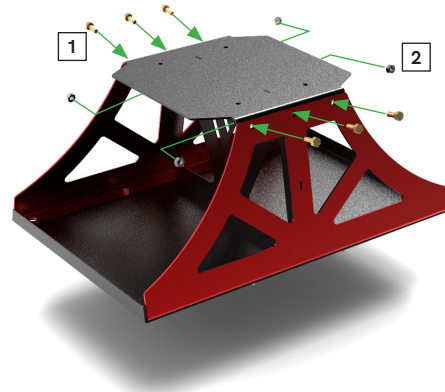
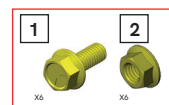

STEP 4

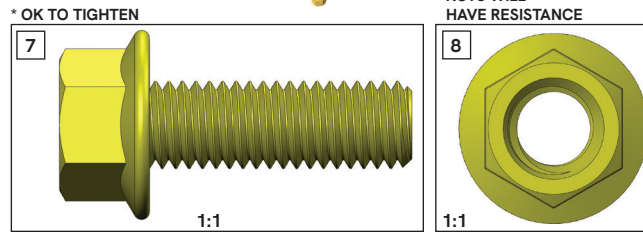
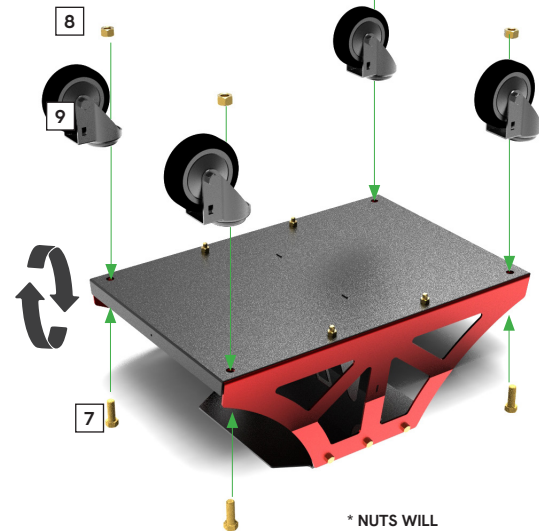
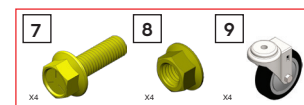

STEP 5

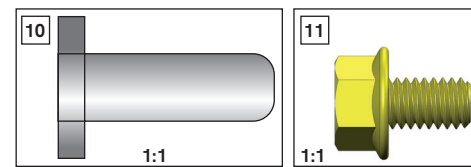
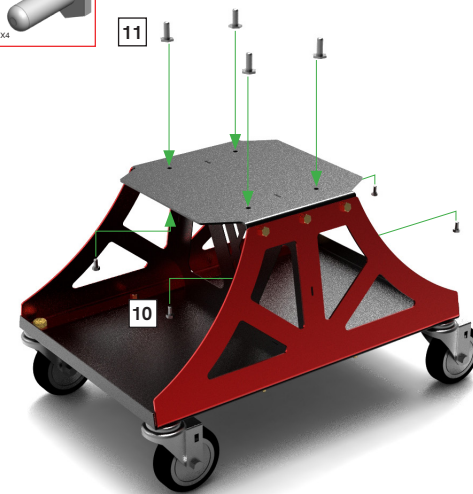
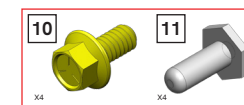

STEP 6

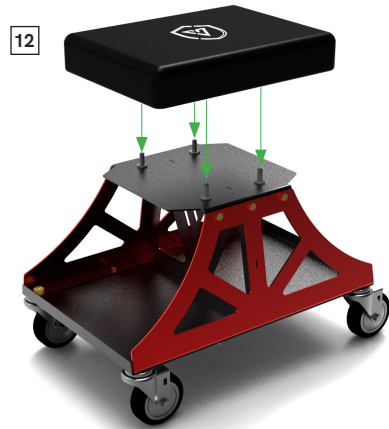

12

* WARNING: ALL SEAT STUDS MUST BE FULLY PRESSED INTO THE SEAT BEFORE USE.

PARTS

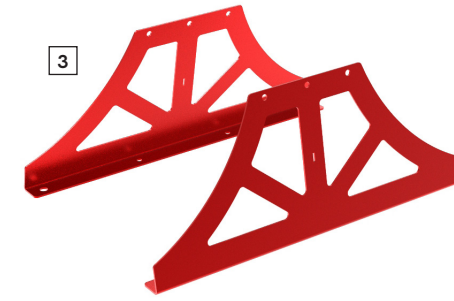
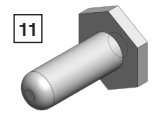
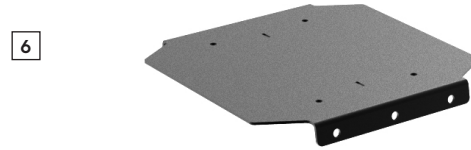
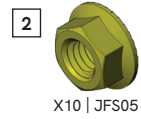
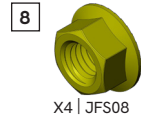
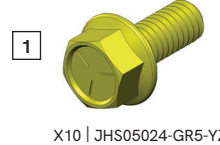
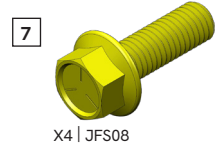

ACCESSORIES

Keep things looking pretty with your right hand man, our polisher holder

Go nowhere fast and keep your chair from going rogue by equipping our locking caster attachment



Sit back and relax with our ergonomic back rest, designed to help improve posture and provide relief for bad backs

Need a drink? How about two? Low Pro Cup Holder contains two stainless steel cupholders and outside rubber protectors and holes for cleaning brushes

PICK UP SOME OF THE LATEST GEAR!



www.vyperindustrial.com
www.vyperenergy.com



VYPER INDUSTRIAL CUSTOMER SERVICE
 (920) 301-3822 OR sales@vyperindustrial.com
 VISIT WWW.VYPERINDUSTRIAL.COM

VYPER

SHARE THE LOVE!

If you love your VYPER CHAIR, we'd be honored if you left us a review on our website!

Want a VYPER \$25 gift card?

Take a screenshot of your review and email it to: sales@vyperindustrial.com

STILL HAVE QUESTIONS?

Visit: www.vyperindustrial.com/pages/assembly-tutorials

Call: 920.301.3822



RETURN INFO

If your chair was damaged during shipping please follow the steps below:

Take a picture of the box and parts that were damaged along with your packing slip
Send pictures to sales@vyperindustrial.com with your order number
Once we receive the inquiry, we will contact you to resolve the issue

To review our refund policy, please visit: www.vyperindustrial.com/policies/refund-policy



CONTACT US

Please contact us at anytime with any questions, concerns or feedback. One of our team members will be in touch with you.



sales@vyperindustrial.com



920.301.3822