

VYPER

ASSEMBLY GUIDE

ELEVATED STEEL *MAX*

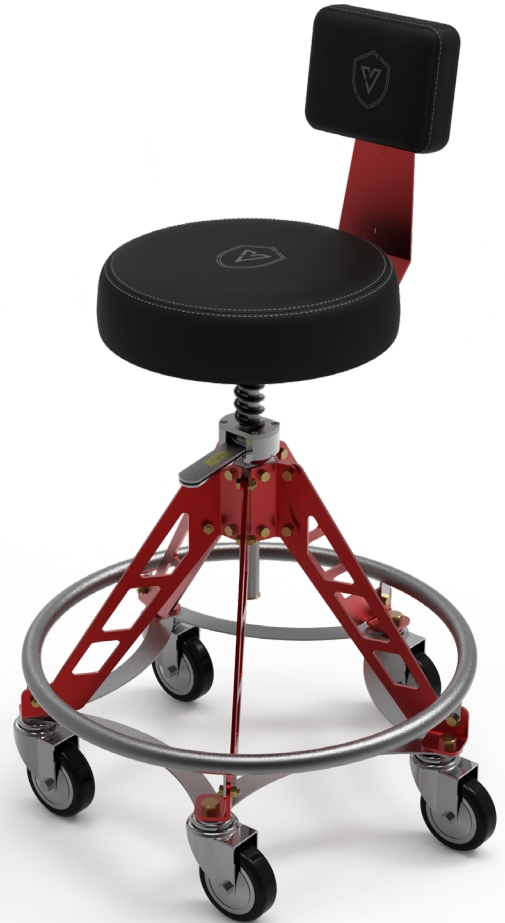
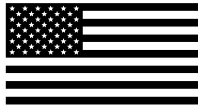

WARNING

Safety & Warnings

The VYPER CHAIR complies with all legally prescribed safety rules and regulations. Inappropriate use may cause damage to the product and injury or death to persons.

It is crucial to read the operation manual prior to using the VYPER CHAIR. It provides you with important information about safe and proper assembly, use and maintenance of the VYPER CHAIR.

Children should never use this VYPER CHAIR unless closely supervised by an adult.

Do not allow horseplay on or around the VYPER CHAIR.

SERIOUS OR FATAL INJURY CAN OCCUR FROM THE VYPER CHAIR FROM TIPPING OVER OR FALLING OFF OF THE VYPER CHAIR.

ACCORDINGLY:

Keep weight centered when using the VYPER CHAIR.

Only use VYPER CHAIR on a flat level surface, free of debris.

Keep one or both feet on the ground at all times when sitting on the VYPER CHAIR.

Never stand on the VYPER CHAIR.

Never allow more than one person on the VYPER CHAIR.

DO NOT USE THE VYPER CHAIR IF IT APPEARS DAMAGED OR BROKEN.

WARNING: To avoid the danger of suffocation, keep this plastic bag away from babies and children. Do not use this bag in cribs, beds, carriages or playpens. This bag is not a toy.

Read all instructions before assembly and use of VYPER CHAIR. Failure to comply with and observe all assembly, safety, operating instructions and warnings regarding the use of the VYPER CHAIR may result in serious bodily injury or death.

This includes strictly following all assembly instructions in the order in which they appear.

Assembling any VYPER CHAIR in an order other than that set out in the instructions increases the risk of product damage or injury or death to individuals.

Never attempt to sit on the VYPER CHAIR until it is fully assembled and all the fasteners are tightened in accordance with the assembly instructions. Failure to comply with this warning can lead to product damage and injury or death to individuals.

Do not attempt to repair any broken or defective parts or assemble using any parts that are damaged or defective. Please contact manufacturer immediately at: sales@vyperindustrial.com

Never use substitute parts when assembling the VYPER CHAIR. Please contact manufacturer immediately if replacement parts are needed from VYPER CHAIR.



VYPER

VYPER was founded by the Rusch Family, a family that spent countless hours in the garage, starting one project after another. After years of torture using cheap chairs and hundreds of falls, Chris Rusch (known for being a master in metal shaping), designed & built the first ever VYPER CHAIR.

The VYPER CHAIR is strategically designed to prevent tipping over while rolling, provide relieving back support, improve sitting posture and increase comfort while using the highest quality American-made materials.

With their passion for the garage industry, Dayne and Dylan (the brothers) took over VYPER years ago with the determination to launch the highest quality products in any industry under the VYPER Brand while continuing to provide jobs to the American people.

TOOLS REQUIRED FOR ASSEMBLY

1/2" WRENCH AND/OR SOCKET | 3/4" WRENCH AND/OR SOCKET

x2



or x2



x2



or x2



3/8" WRENCH AND/OR SOCKET | 5/32" HEX KEY WRENCH

x1



or x1



x1



***POWER TOOLS NOT RECOMMENDED!**

STEP 1

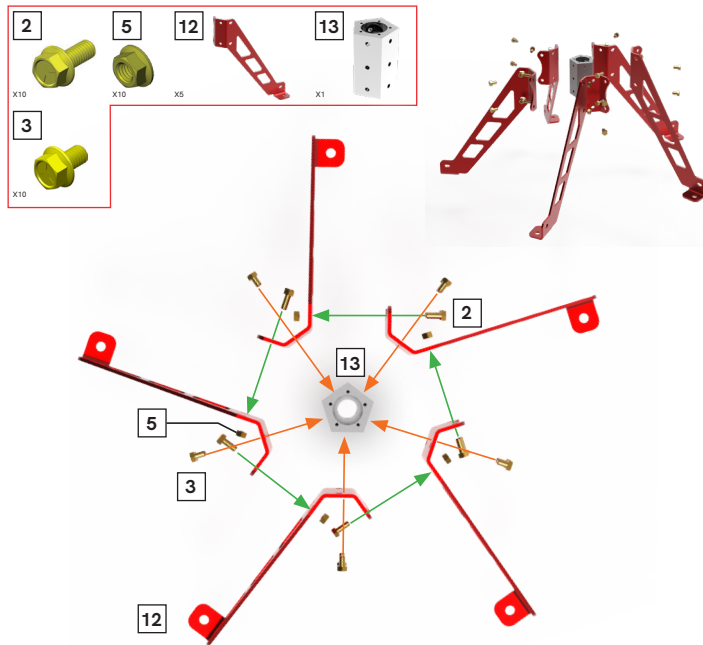

* DO NOT TIGHTEN BOLTS

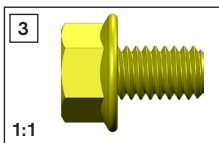
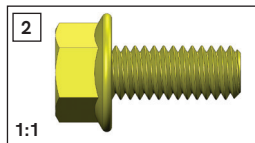

* NUTS WILL HAVE RESISTANCE

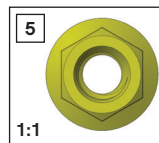

STEP 2

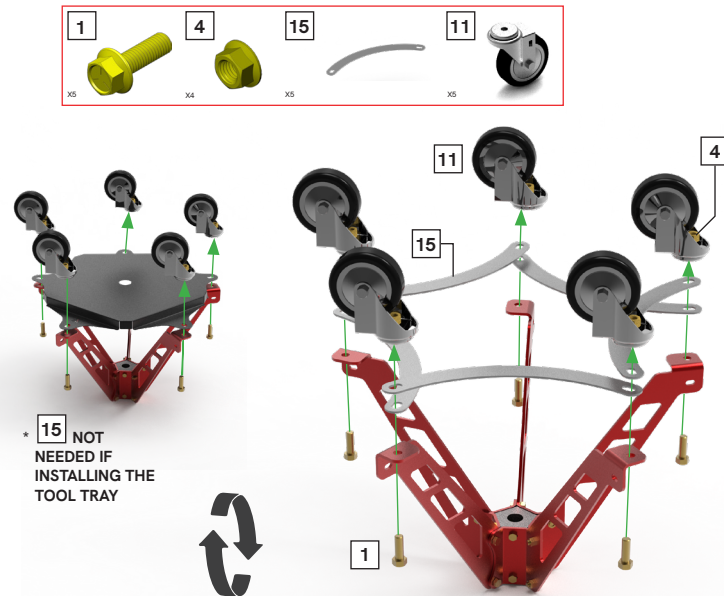

* DO NOT TIGHTEN BOLTS

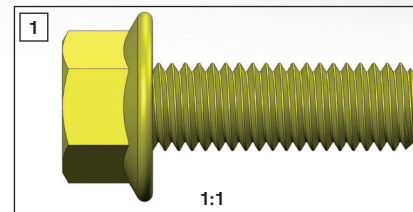

* NUTS WILL HAVE RESISTANCE

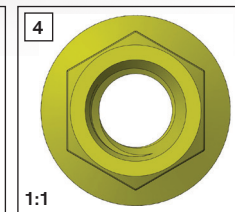

STEP 3

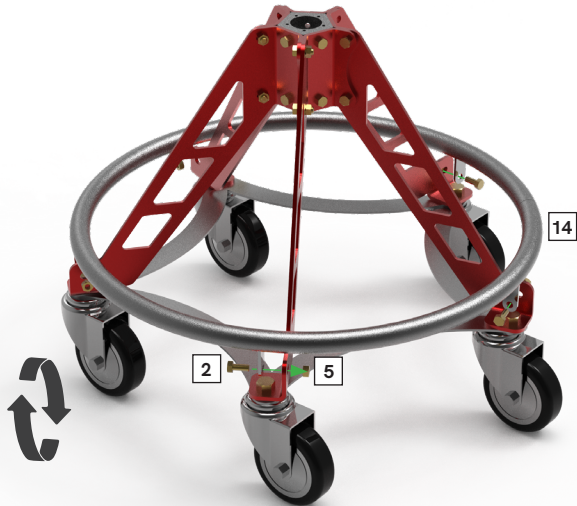
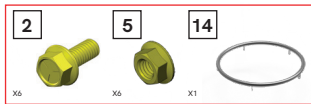

* OK TO TIGHTEN ALL NUTS AND BOLTS

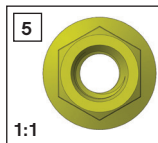
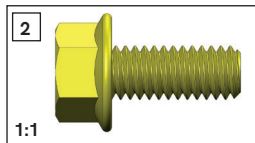

STEP 4



ACME ASSEMBLY ONLY

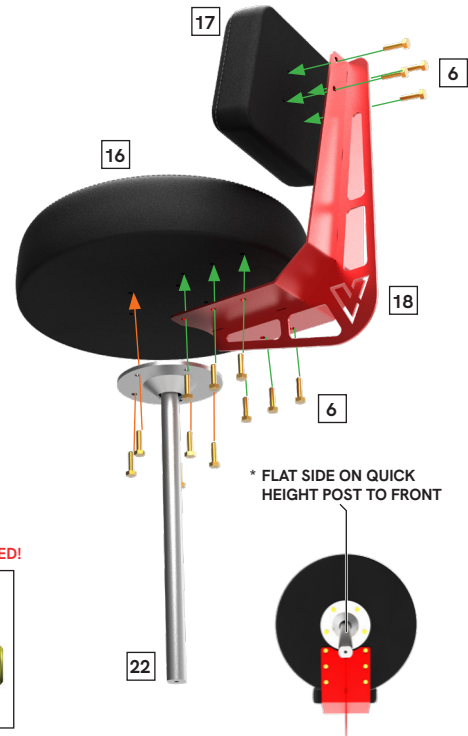

*POWER TOOLS NOT RECOMMENDED!

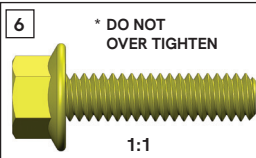

* FLAT SIDE ON QUICK HEIGHT POST TO FRONT

STEP 5 | QUICK HEIGHT CHAIRS ONLY

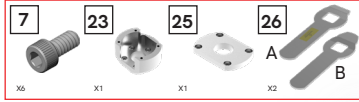

QUICK HEIGHT HUB ASSEMBLY



* WARNING LABEL ON TOP - LEAVE IN PLASTIC WRAP DURING INSTALLATION

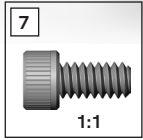
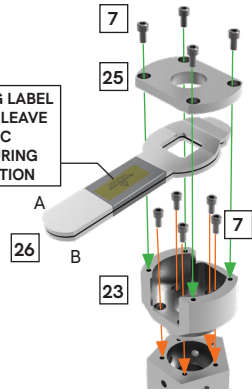

STEP 6 | QUICK HEIGHT CHAIRS ONLY

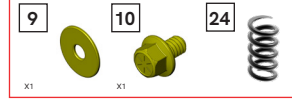

* FLAT SIDE ON QUICK HEIGHT POST TO FRONT

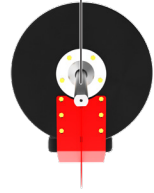

* REMOVE PLASTIC WRAP AND LIFT HANDLES AS QUICK HEIGHT ROD IS LOWERED INTO HUB

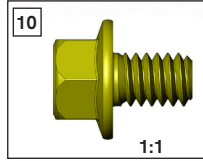
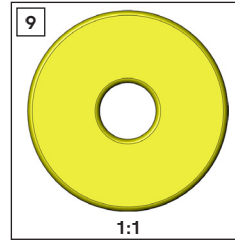
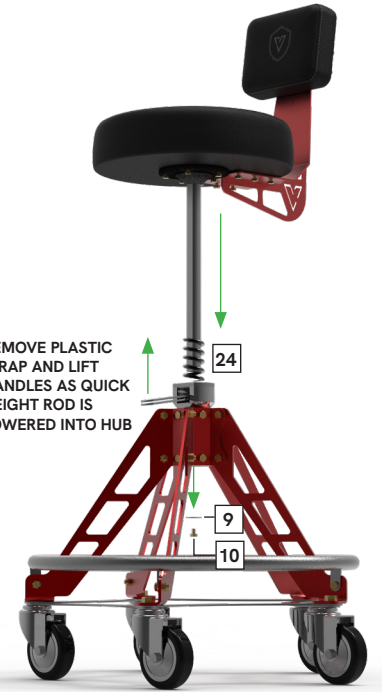

STEP 5A | ACME ROD CHAIRS ONLY



* ACME SCREW
NUT ORIENTATION

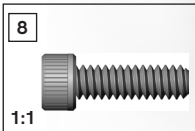

STEP 6A | ACME ROD CHAIRS ONLY

* ROTATE CLOCKWISE
TO INSTALL



* MAX HEIGHT FROM
TOP OF CUSHION TO
FLOOR 32"
MAY CAUSE INJURY IF
SEAT IS RAISED ABOVE
32" FROM FLOOR



OPERATION | QUICK HEIGHT CHAIRS ONLY

QUICK HEIGHT OPERATION

LOWERING THE SEAT:
REMOVE WEIGHT FROM SEAT. WHILE HOLDING SEAT WITH ONE HAND, PULL UP ON THE LEVERS AND PUSH THE SEAT DOWN TO DESIRED HEIGHT, RELEASE THE LEVERS.

* TO AVOID INJURY OR DAMAGE TO THE CHAIR, DO NOT PULL LEVERS WHILE SITTING ON CHAIR! THE SEAT WILL DROP QUICKLY RESULTING IN INJURY OR DAMAGE TO THE CHAIR.

RAISING THE SEAT:
REMOVE WEIGHT FROM SEAT. WITH BOTH HANDS OPPOSITE EACH OTHER ON THE SEAT, LIFT TO THE DESIRED HEIGHT.

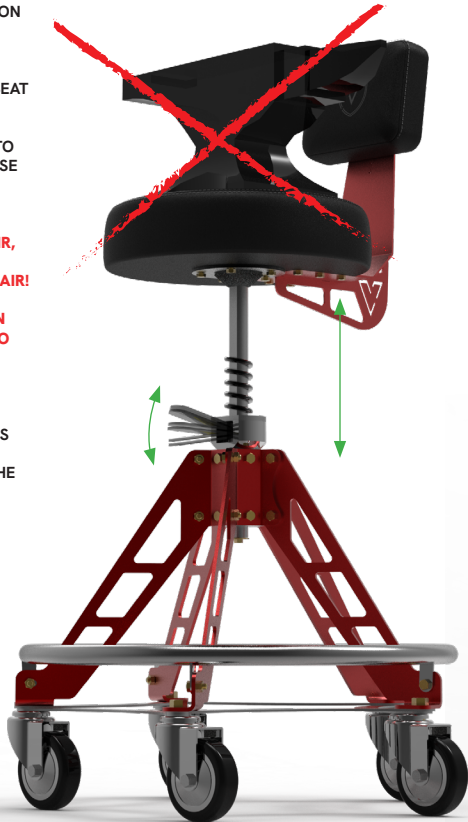

OPERATION | ACME ROD CHAIRS ONLY

ACME ROD OPERATION

THREAD ACME ROD
CLOCKWISE INTO ACME NUT TO LOWER THE SEAT.

* MAX HEIGHT FROM TOP OF CUSHION TO FLOOR 24"
MAY CAUSE INJURY IF SEAT IS RAISED ABOVE 24" FROM FLOOR (REFERENCE STEP 6A).

TIGHTEN SEAT CLAMP ONCE SEAT IS AT DESIRED HEIGHT. ENSURE CLAMP IS PROPERLY CLAMPED, THE CLAMP LEVER MUST BE AGAINST COLLAR.

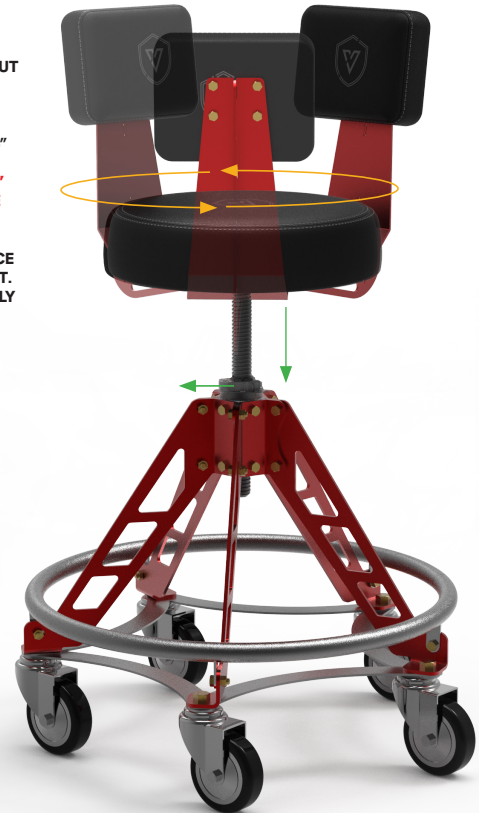
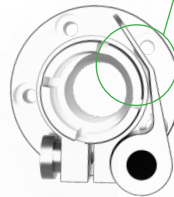

AVAILABLE ACCESSORIES

SIDEKICK

Need a drink?
How about two?

The SideKick contains two stainless steel cup holders, outside rubber protectors and holes for cleaning brushes.

TOWEL RACK

Keep your towels clean and off the ground with the SideKick's Towel Rack.

TOOL TRAY

Increase efficiency through organization by adding a tool tray to your chair!

BIG BOY

Increase the width of your VYPER CHAIR seat with the two side cushion adapters.

WHEEL LOCKS

Keep your chair from going rogue with our locking caster attachment.



TROUBLESHOOTING

MY CASTER(S) DO NOT SWIVEL

BE SURE CASTER BOLTS ARE NOT OVERTIGHTENED
SLIGHTLY LOOSEN CASTER NUT (ITEM #5) UNTIL CASTER ROTATES SMOOTHLY. IF PROBLEM PERSISTS INSPECT CASTER FOR DAMAGE.

CHAIR HAS SLIGHT WOBBLE

ENSURE ALL NUTS AND BOLTS HAVE BEEN TIGHTENED
POWER TOOLS ARE NO RECOMMENDED. IF PROBLEM PERSISTS, CRACK LOOSE LEG AND RAIL BOLTS. PLACE CHAIR ON FLAT AND LEVEL SURFACE AND RE-TIGHTEN.

SEAT NOT STAYING AT DESIRED HEIGHT (QUICK HEIGHT MODEL)

REFER TO STEP 5

THE LONGER LEVER IS ON THE BOTTOM, ANGLED UPWARD AND THE SHORTER LEVER (WITH WARNING LABEL) IS ON THE TOP, ANGLED UPWARD AS WELL. THE LEVERS ARE TO GRIP THE FLATS OF THE SHAFT.

(AS OF 11.01.22 - 3 LEVER QUICK HEIGHT SYSTEM UPDATED TO 2 HANDLE SYSTEM)

SEAT SHAFT DOES NOT GO THROUGH CENTER HUB

REFER TO STEP 1

ENSURE THAT THE CORRECT BOLTS WERE INSTALLED TO ATTACH THE LEGS TO THE CENTER HUB.

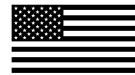

VYPER INDUSTRIAL CUSTOMER SERVICE

(920) 301-3822 OR sales@vyperindustrial.com

VISIT WWW.VYPERINDUSTRIAL.COM

PARTS

1

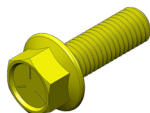

X5 | JHS08048-GR5-YZ

2



X15 | JHS05024-GR5-YZ

3



X10 | JHS05016-YZ

4



X5 | JFS08

5



X15 | JFS05

6

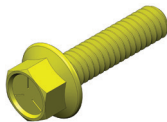

X15 | JHS04032-GR5-YZ

7



X9 | JAA03012

8



X5 | JAA03020

9



X1 | 14RC-7015

10



X1 | JHS04012-YZ

11



X5 | 4" SWIVEL CASTER

12



X5 | SUPPORT LEG

13



X1 | CENTER HUB

14

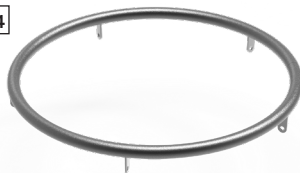

X1 | ELEVATED STEEL FOOT RAIL

15



X5 | ELEVATED LEG BRACE

16



X1 | SEAT

17



X1 | BACKREST CUSHION

18

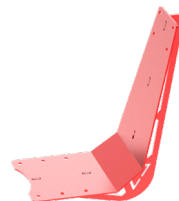

X1 | SEAT BACK BRACKET

19



X1 | ACME SEAT POST

22



X1 | QH SEAT POST

24



X1 | DAMPENING SPRING

25



X1 | LATCH CAP

20



X1 | SEAT CLAMP

23



X1 | HEIGHT ADJUST HUB

26

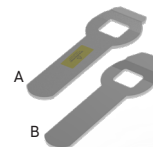

X2 | SQ LEVERS

21



X1 | CLAMP ACME SCREW NUT



VYPER INDUSTRIAL CUSTOMER SERVICE

(920) 301-3822 OR sales@vyperindustrial.com

VISIT WWW.VYPERINDUSTRIAL.COM

VYPER

SHARE THE LOVE!

If you love your VYPER CHAIR, we'd be honored if you left us a review on our website!

Want a VYPER \$25 gift card?

Take a screenshot of your review and email it to: sales@vyperindustrial.com

STILL HAVE QUESTIONS?

Visit: www.vyperindustrial.com/pages/assembly-tutorials

Call: 920.301.3822

ELEVATED STEELSM



RETURN INFO

If your chair was damaged during shipping please follow the steps below:

Take a picture of the box and parts that were damaged along with your packing slip

Send pictures to sales@vyperindustrial.com with your order number

Once we receive the inquiry, we will contact you to resolve the issue

To review our refund policy, please visit: www.vyperindustrial.com/policies/refund-policy

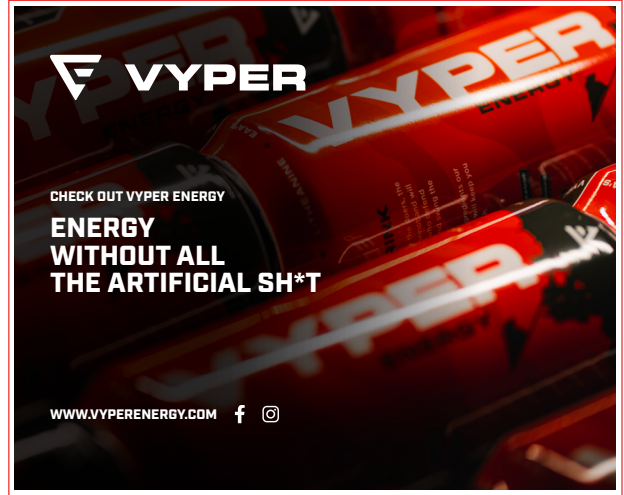

CONTACT US

Please contact us at anytime with any questions, concerns or feedback and we will respond as soon as possible.



sales@vyperindustrial.com



920.301.3822