



THE OUTDOOR PLUS

USA MANUFACTURER OF FIRE & WATER PRODUCTS



**PAN & BURNER
COMPONENTS CATALOG**

701 S DUPONT AVE. ONTARIO, CA
THEOUTDOORPLUS.COM
SALES@THEOUTDOORPLUS.COM

COMPONENTS - TABLE OF CONTENTS

◆ **Table of Contents**

◆ **3 Burner information**

- 3 Bullet Burner® Information

◆ **4 Pans & Burners**

- 4 Flat Pan & Brass Bullet Pans Burners
- 8 Drop In Pans & Brass Bullet Burners®
- 12 Flat Pans & Stainless Steel Bullet Burners®
- 19 Drop In Pans & Stainless Steel Bullet Burners®
- 27 Flat Pans & Stainless Steel Burners
- 34 Drop in Pans & Stainless Steel Burners
- 41 Raised Lip Pans & Stainless Steel Burners
- 44 Lipless Pans & Stainless Steel Burners

◆ **48 Burners**

- 48 Brass & Stainless Steel Bullet Burners®
- 50 Stainless Steel Burners

◆ **54 Fireplace Burners**

◆ **55 Fireplace Screens**

◆ **56 SMART WEATHER ELECTRONIC IGNITION SYSTEMS (SWEIS)**

- 56 Electronic Ignition Systems
- 57 Accessories & Add-Ons
- 58 SWEIS Replacement Components
- 58 Spark Ignition Kits
- 60 Flame Sense Kits
- 60 Flame Sense Replacement Components
- 61 Gas Kits
- 62 Gas Kit Components & Accessories

- 63 Fire Pit Add-Ons

◆ **66 Introducing Flame Sense**

◆ **67 BUILD your own fire pit**



- 67 Paver Kits, Mounting Brackets
- 67 Access Doors, Vents

◆ **69 Clearance From Combustibles Information**

Legend

SS = Stainless Steel

SWEIS = Smart Weather Electronic Ignition System

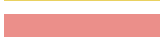
-  *Flame Sense with Match Lit System*
-  *Flame Sense with Spark Ignition*
-  *Low Voltage Electronic Ignition*
-  *Plug & Play to Low Voltage Ignition*



THE OUTDOOR PLUS

USA MANUFACTURER OF FIRE & WATER PRODUCTS

Our Patented Bullet Burner® is the perfect way to get more out of any pre-existing fire pit. Its 1/2" gas inlet makes it easy to swap out with any pre-existing burner.

You can expect to get the same flame height while using less gas than your standard burner, or crank it up for a dramatic and impressive flame, taller than any standard burner is able to produce.



Uniform Gas Flow Generator

Our Patented Hub Distributes Gas Evenly Throughout The Burner

Curved Design

Distributes The Bullet Orifices Evenly To Create A Fuller Flame



BULLET ORIFICE FLAME SPREADER

Precision Machined Components

Gives You Consistent Quality & Durability That You Can Rely On

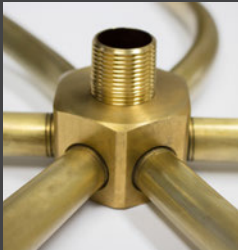

Flat Flame Technology

Our Patented Bullet Orifice Compresses Gas Flow & Incorporates Oxygen To Create A Cleaner Flame

Individually Assembled

Quality Control To Provide You With A Great Product Every Single Time



IMPORT BURNER



PATENTED BULLET BURNER®

FLAT PAN BRASS BULLET BURNER® KITS *PATENTED DESIGN*

The Patented Bullet Burner's® eliminate the need for an additional LP air mixer. Suitable for either natural gas or liquid propane applications. Electronic ignition systems require 10" clearance below the pan. 110V Ignition System Kits use a 3-prong grounded plug.

BURNER SIZE GUIDE: **M** = Double Inlet and uses manifold that adds 5" in height below the pan ; **2R** = 2 Rings ; **3R** = 3 Rings ; **4R** = 4 Rings

Low Voltage Ignition

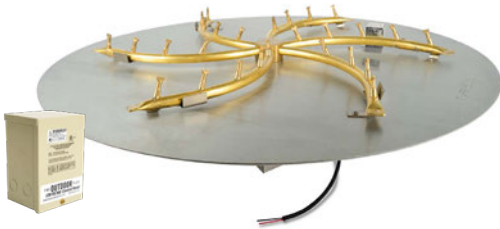

Plug & Play To Low Voltage



Flame Sense



Round Flat Pan & Triple S Bullet Burner®

ITEM	PAN & BURNER ONLY	FLAME SENSE MATCH LIT CERTIFIED	FLAME SENSE W/ SPARK IGNITION	LOW VOLTAGE	PLUG & PLAY TO LOW VOLTAGE	BURNER SIZE	GAS INLET	BTU
18" Pan Kit - A	OPT-BFP18R	OPT-BFP18RFSML	OPT-BFP18RFSEN	OPT-BFP18RE12	OPT-BFP18RE110	8"	½"	50,000
18" Pan Kit - B	OPT-BFP182R	OPT-BFP182RFSML	OPT-BFP182RFSEN	OPT-BFP182RE12	OPT-BFP182RE110	12"	½"	75,000
24" Pan Kit	OPT-BFP24R	OPT-BFP24RFSML	OPT-BFP24RFSEN	OPT-BFP24RE12	OPT-BFP24RE110	18"	½"	110,000
30" Pan Kit	OPT-BFP30R	N/A	OPT-BFP30RFSEN	OPT-BFP30RE12	OPT-BFP30RE110	24"	½"	145,000
36" Pan Kit	OPT-BFP36R	N/A	OPT-BFP36RFSEN	OPT-BFP36RE12	OPT-BFP36RE110	30"	¾"	180,000
48" Pan Kit	OPT-BFP48R	N/A	N/A	OPT-BFP48RE12	OPT-BFP48RE110	36"	¾"	220,000
60" Pan Kit	OPT-BFP60R	N/A	N/A	OPT-BFP60RE12	OPT-BFP60RE110	48"	¾"	385,000



Uniform Gas Flow Generator
- Patented Hub distributes Gas Evenly Throughout The Burner



ELECTRONIC IGNITION ACCESSORIES



REMOTE CONTROL & WIRELESS RECEIVER
OPT-RC110V



WEATHERPROOF ON/OFF SWITCH
OPT-WPS110V



110V EMERGENCY STOP BUTTON
OPT-ESTOP



110V 1-HOUR DIAL TIMER
OPT-DTM

GAS ACCESSORIES



GAS TIMER & EMERGENCY STOP
OPT-ESTOPTM



NATURAL GAS KIT
OPT-NGKNG - 0-290K BTU
OPT-NGKNGHC - 291K+ BTU



LIQUID PROPANE KIT
OPT-LPKLP - 0-290K BTU
OPT-LPKLPHC - 291K+ BTU

Low Voltage Ignition



Plug & Play To Low Voltage



Flame Sense



Square Flat Pan & Triple S Bullet Burner®

ITEM	PAN & BURNER ONLY	FLAME SENSE MATCH LIT CERTIFIED	FLAME SENSE W/ SPARK IGNITION	LOW VOLTAGE	PLUG & PLAY TO LOW VOLTAGE	BURNER SIZE	GAS INLET	BTU
18" Pan Kit - A	OPT-BFP18S	OPT-BFP18SFMSML	OPT-BFP18SFSEEN	OPT-BFP18SE12	OPT-BFP18SE110	8"	½"	50,000
18" Pan Kit - B	OPT-BFP182S	OPT-BFP182SFMSML	OPT-BFP182SFSEEN	OPT-BFP182SE12	OPT-BFP182SE110	12"	½"	75,000
24" Pan Kit	OPT-BFP24S	OPT-BFP24SFMSML	OPT-BFP24SFSEEN	OPT-BFP24SE12	OPT-BFP24SE110	18"	½"	110,000
30" Pan Kit	OPT-BFP30S	N/A	OPT-BFP30SFSEEN	OPT-BFP30SE12	OPT-BFP30SE110	24"	½"	145,000
36" Pan Kit	OPT-BFP36S	N/A	OPT-BFP36SFSEEN	OPT-BFP36SE12	OPT-BFP36SE110	30"	¾"	180,000
48" Pan Kit	OPT-BFP48S	N/A	N/A	OPT-BFP48SE12	OPT-BFP48SE110	36"	¾"	220,000
60" Pan Kit	OPT-BFP60S	N/A	N/A	OPT-BFP60SE12	OPT-BFP60SE110	48"	¾"	385,000



Uniform Gas Flow Generator
- Patented Hub distributes Gas Evenly Throughout The Burner



FLAT PAN BRASS BULLET BURNER® KITS PATENTED DESIGN

The Patented Bullet Burner's® eliminate the need for an additional LP air mixer. Suitable for either natural gas or liquid propane applications. Electronic ignition systems require 10" clearance below the pan. 110V Ignition System Kits use a 3-prong grounded plug.

BURNER SIZE GUIDE: **M** = Double Inlet and uses manifold that adds 5" in height below the pan ; **2R** = 2 Rings ; **3R** = 3 Rings ; **4R** = 4 Rings

Low Voltage Ignition



Plug & Play To Low Voltage



Flame Sense



Rectangular Flat Pan & Linear Bullet Burner®

ITEM	PAN & BURNER ONLY	FLAME SENSE MATCH LIT CERTIFIED	FLAME SENSE W/ SPARK IGNITION	LOW VOLTAGE	PLUG & PLAY TO LOW VOLTAGE	BURNER SIZE	GAS INLET	BTU
24"x8" Pan Kit	OPT-BFP24RT	OPT-BFP24RTFSML	OPT-BFP24RTFSEN	OPT-BFP24RTE12	OPT-BFP24RTE110	18"	½"	40,000
36"x8" Pan Kit	OPT-BFP36RT	OPT-BFP36RTFSML	OPT-BFP36RTFSEN	OPT-BFP36RTE12	OPT-BFP36RTE110	30"	½"	60,000
48"x8" Pan Kit	OPT-BFP48RT	OPT-BFP48RTFSML	OPT-BFP48RTFSEN	OPT-BFP48RTE12	OPT-BFP48RTE110	42"	½"	85,000
60"x8" Pan Kit	OPT-BFP60RT	OPT-BFP60RTFSML	OPT-BFP60RTFSEN	OPT-BFP60RTE12	OPT-BFP60RTE110	48"	½"	100,000
72"x8" Pan Kit	OPT-BFP72RT	OPT-BFP72RTFSML	OPT-BFP72RTFSEN	OPT-BFP72RTE12	OPT-BFP72RTE110	60"	¾"	120,000
84"x8" Pan Kit	OPT-BFP84RT	N/A	N/A	OPT-BFP84RTE12	OPT-BFP84RTE110	72"	¾"	145,000
96"x8" Pan Kit	OPT-BFP96RT	N/A	N/A	OPT-BFP96RTE12	OPT-BFP96RTE110	84"	¾"	170,000



Raised Gas Hub



ELECTRONIC IGNITION ACCESSORIES



GAS ACCESSORIES



Low Voltage Ignition

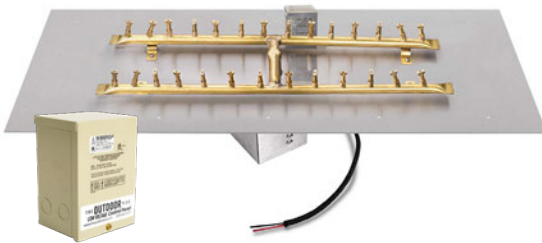

Plug & Play To Low Voltage



Flame Sense



Rectangular Flat Pan & 'H' Bullet Burner®

ITEM	PAN & BURNER ONLY	FLAME SENSE MATCH LIT CERTIFIED	FLAME SENSE W/ SPARK IGNITION	LOW VOLTAGE	PLUG & PLAY TO LOW VOLTAGE	BURNER SIZE	GAS INLET	BTU
24"x12" Pan Kit	OPT-BFP1224R	OPT-BFP1224RFSML	OPT-BFP1224RFSEN	OPT-BFP1224RE12	OPT-BFP1224RE110	18" x 6"	½"	85,000
36"x12" Pan Kit	OPT-BFP1236R	OPT-BFP1236RFSML	OPT-BFP1236RFSEN	OPT-BFP1236RE12	OPT-BFP1236RE110	24" x 6"	½"	110,000
48"x12" Pan Kit	OPT-BFP1248R	OPT-BFP1248RFSML	OPT-BFP1248RFSEN	OPT-BFP1248RE12	OPT-BFP1248RE110	36" x 6"	½"	160,000
60"x12" Pan Kit	OPT-BFP1260R	N/A	N/A	OPT-BFP1260RE12	OPT-BFP1260RE110	48" x 6"	½"	205,000
72"x12" Pan Kit	OPT-BFP1272R	N/A	N/A	OPT-BFP1272RE12	OPT-BFP1272RE110	60" x 6" (M)	¾"	255,000
84"x12" Pan Kit	OPT-BFP1284R	N/A	N/A	OPT-BFP1284RE12	OPT-BFP1284RE110	72" x 6" (M)	¾"	300,000
96"x12" Pan Kit	OPT-BFP1296R	N/A	N/A	OPT-BFP1296RE12	OPT-BFP1296RE110	84" x 6" (M)	¾"	350,000



Raised Gas Hub

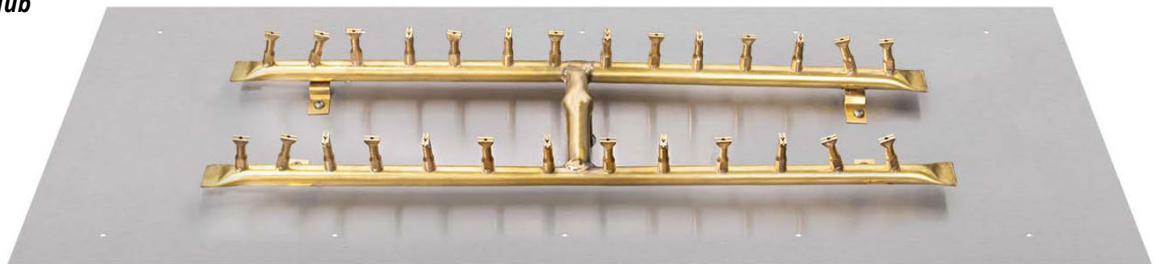

The Patented Bullet Burner's eliminate the need for an additional LP air mixer. Suitable for either natural gas or liquid propane applications. Pans have 1" Lip & 2.5" Height. Electronic ignition requires 10" clearance below the pan. 110V Ignition System Kits use a 3-prong grounded plug.

BURNER SIZE GUIDE: **M** = Double Inlet and uses manifold that adds 5" in height below the pan ; **2R** = 2 Rings ; **3R** = 3 Rings ; **4R** = 4 Rings

Low Voltage Ignition



Plug & Play To Low Voltage



Flame Sense



SS Round Drop In Pan & Triple S Bullet Burner®

ITEM	PAN & BURNER ONLY	FLAME SENSE MATCH LIT CERTIFIED	FLAME SENSE W/ SPARK IGNITION	LOW VOLTAGE	PLUG & PLAY TO LOW VOLTAGE	BURNER SIZE	GAS INLET	BTU
13" Pan Kit	OPT-BP13RD	OPT-BP13RDFSML	OPT-BP13RDFSEN	OPT-BP13RDE12	OPT-BP13RDE110	8"	½"	50,000
19" Pan Kit	OPT-BP19RD	OPT-BP19RDFSML	OPT-BP19RDFSEN	OPT-BP19RDE12	OPT-BP19RDE110	12"	½"	75,000
25" Pan Kit	OPT-BP25RD	OPT-BP25RDFSML	OPT-BP25RDFSEN	OPT-BP25RDE12	OPT-BP25RDE110	18"	½"	110,000
31" Pan Kit	OPT-BP31RD	N/A	OPT-BP31RDFSEN	OPT-BP31RDE12	OPT-BP31RDE110	24"	½"	145,000
37" Pan Kit	OPT-BP37RD	N/A	N/A	OPT-BP37RDE12	OPT-BP37RDE110	30"	¾"	180,000
43" Pan Kit	OPT-BP43RD	N/A	N/A	OPT-BP43RDE12	OPT-BP43RDE110	36"	¾"	220,000



1" Flange
2" Depth



Uniform Gas Flow Generator
- Patented Hub distributes Gas Evenly Throughout The Burner



ELECTRONIC IGNITION ACCESSORIES



GAS ACCESSORIES



Low Voltage Ignition

Plug & Play To Low Voltage

Flame Sense

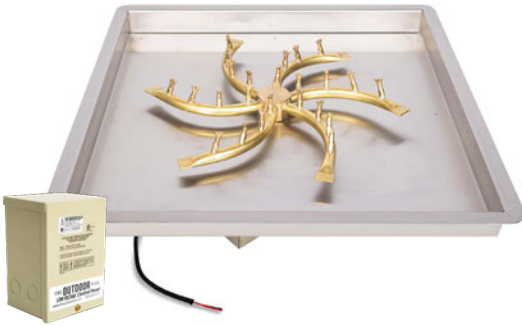

SS Square Drop In Pan & Bullet Burner®

ITEM	PAN & BURNER ONLY	FLAME SENSE MATCH LIT CERTIFIED	FLAME SENSE W/ SPARK IGNITION	LOW VOLTAGE	PLUG & PLAY TO LOW VOLTAGE	BURNER SIZE	GAS INLET	BTU
12" Pan Kit	OPT-BP12SD	OPT-BP12SDFSML	OPT-BP12SDFSEN	OPT-BP12SDE12	OPT-BP12SDE110	8"	½"	50,000
18" Pan Kit	OPT-BP18SD	OPT-BP18SDFSML	OPT-BP18SDFSEN	OPT-BP18SDE12	OPT-BP18SDE110	12"	½"	75,000
24" Pan Kit	OPT-BP24SD	OPT-BP24SDFSML	OPT-BP24SDFSEN	OPT-BP24SDE12	OPT-BP24SDE110	18"	½"	110,000
30" Pan Kit	OPT-BP30SD	N/A	N/A	OPT-BP30SDE12	OPT-BP30SDE110	24"	½"	145,000
36" Pan Kit	OPT-BP36SD	N/A	N/A	OPT-BP36SDE12	OPT-BP36SDE110	30"	¾"	180,000
48" Pan Kit	OPT-BP48SD	N/A	N/A	OPT-BP48SDE12	OPT-BP48SDE110	36"	¾"	220,000



**1" Flange
2.5" Depth**



Uniform Gas Flow Generator
- Patented Hub distributes Gas Evenly Throughout The Burner



DROP-IN PAN BRASS BULLET BURNER® KITS

PATENTED DESIGN

The Patented Bullet Burner's eliminate the need for an additional LP air mixer. Suitable for either natural gas or liquid propane applications. Pans have 1" Lip & 2.5" Height. Electronic ignition requires 10" clearance below the pan. 110V Ignition System Kits use a 3-prong grounded plug.

BURNER SIZE GUIDE: **M** = Double Inlet and uses manifold that adds 5" in height below the pan ; **2R** = 2 Rings ; **3R** = 3 Rings ; **4R** = 4 Rings

Low Voltage Ignition

Plug & Play To Low Voltage

Flame Sense



SS Rectangular Drop In Pan & Linear Bullet Burner®

ITEM	PAN & BURNER ONLY	FLAME SENSE MATCH LIT CERTIFIED	FLAME SENSE W/ SPARK IGNITION	LOW VOLTAGE	PLUG & PLAY TO LOW VOLTAGE	BURNER SIZE	GAS INLET	BTU
24"x8" Pan Kit	OPT-BP824RD	OPT-BP824RDFSML	OPT-BP824RDFSEN	OPT-BP824RDE12	OPT-BP824RDE110	18"	1/2"	40,000
36"x8" Pan Kit	OPT-BP836RD	OPT-BP836RDFSML	OPT-BP836RDFSEN	OPT-BP836RDE12	OPT-BP836RDE110	24"	1/2"	50,000
48"x8" Pan Kit	OPT-BP848RD	OPT-BP848RDFSML	OPT-BP848RDFSEN	OPT-BP848RDE12	OPT-BP848RDE110	36"	1/2"	75,000
60"x8" Pan Kit	OPT-BP860RD	OPT-BP860RDFSML	OPT-BP860RDFSEN	OPT-BP860RDE12	OPT-BP860RDE110	48"	1/2"	100,000
72"x8" Pan Kit	OPT-BP872RD	OPT-BP872RDFSML	OPT-BP872RDFSEN	OPT-BP872RDE12	OPT-BP872RDE110	60"	3/4"	120,000
84"x8" Pan Kit	OPT-BP884RD	N/A	N/A	OPT-BP884RDE12	OPT-BP884RDE110	72"	3/4"	145,000
96"x8" Pan Kit	OPT-BP896RD	N/A	N/A	OPT-BP896RDE12	OPT-BP896RDE110	84"	3/4"	170,000



1" Flange
2.5" Depth



Raised Gas Hub

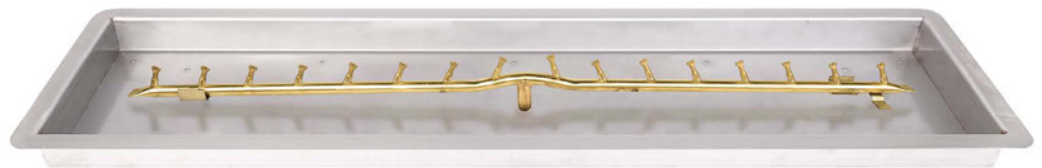

ELECTRONIC IGNITION ACCESSORIES

GAS ACCESSORIES



Low Voltage Ignition

Plug & Play To Low Voltage

Flame Sense

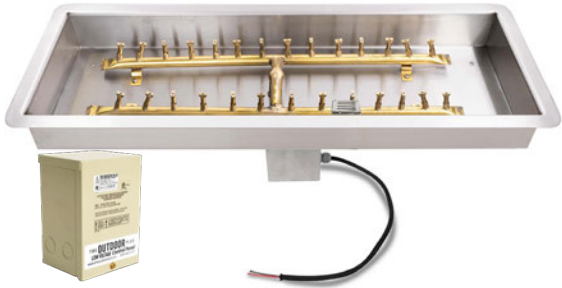

SS Rectangular Drop In Pan & 'H' Bullet Burner[®]

ITEM	PAN & BURNER ONLY	FLAME SENSE MATCH LIT CERTIFIED	FLAME SENSE W/ SPARK IGNITION	LOW VOLTAGE	PLUG & PLAY TO LOW VOLTAGE	BURNER SIZE	GAS INLET	BTU
24"x12" Pan Kit	OPT-BP1224RD	OPT-BP1224RDFSML	OPT-BP1224RDFSEN	OPT-BP1224RDE12	OPT-BP1224RDE110	18" x 6"	½"	85,000
36"x12" Pan Kit	OPT-BP1236RD	OPT-BP1236RDFSML	OPT-BP1236RDFSEN	OPT-BP1236RDE12	OPT-BP1236RDE110	30" x 6"	½"	110,000
48"x12" Pan Kit	OPT-BP1248RD	OPT-BP1248RDFSML	OPT-BP1248RDFSEN	OPT-BP1248RDE12	OPT-BP1248RDE110	42" x 6"	½"	180,000
60"x12" Pan Kit	OPT-BP1260RD	N/A	N/A	OPT-BP1260RDE12	OPT-BP1260RDE110	48" x 6"	½"	205,000
72"x12" Pan Kit	OPT-BP1272RD	N/A	N/A	OPT-BP1272RDE12	OPT-BP1272RDE110	60" x 6" (M)	¾"	255,000
84"x12" Pan Kit	OPT-BP1284RD	N/A	N/A	OPT-BP1284RDE12	OPT-BP1284RDE110	72" x 6" (M)	¾"	300,000
96"x12" Pan Kit	OPT-BP1296RD	N/A	N/A	OPT-BP1296RDE12	OPT-BP1296RDE110	84" x 6" (M)	¾"	350,000



**1" Flange
2.5" Depth**



Raised Gas Hub



The Patented Bullet Burner's eliminate the need for an additional LP air mixer. Suitable for either natural gas or liquid propane applications. Electronic ignition systems require 10" clearance below the pan. 110V Ignition System Kits use a 3-prong grounded plug.

BURNER SIZE GUIDE: **M** = Double Inlet and uses manifold that adds 5" in height below the pan ; **2R** = 2 Rings ; **3R** = 3 Rings ; **4R** = 4 Rings

Low Voltage Ignition



Plug & Play To Low Voltage



Flame Sense



Round Flat Pan & SS Triple S Bullet Burner®

ITEM	PAN & BURNER ONLY	FLAME SENSE MATCH LIT CERTIFIED	FLAME SENSE W/ SPARK IGNITION	LOW VOLTAGE	PLUG & PLAY TO LOW VOLTAGE	BURNER SIZE	GAS INLET	BTU
18" Pan Kit - A	OPT-BFP18RSS	OPT-BFP18RSSFSML	OPT-BFP18RSSFSEN	OPT-BFP18RSSE12	OPT-BFP18RSSE110	8"	½"	50,000
18" Pan Kit - B	OPT-BFP182RSS	OPT-BFP182RSSFSML	OPT-BFP182RSSFSEN	OPT-BFP182RSSE12	OPT-BFP182RSSE110	12"	½"	75,000
24" Pan Kit	OPT-BFP24RSS	OPT-BFP24RSSFSML	OPT-BFP24RSSFSEN	OPT-BFP24RSSE12	OPT-BFP24RSSE110	18"	½"	110,000
30" Pan Kit	OPT-BFP30RSS	N/A	OPT-BFP30RSSFSEN	OPT-BFP30RSSE12	OPT-BFP30RSSE110	24"	½"	145,000
36" Pan Kit	OPT-BFP36RSS	N/A	N/A	OPT-BFP36RSSE12	OPT-BFP36RSSE110	30"	¾"	180,000
48" Pan Kit	OPT-BFP48RSS	N/A	N/A	OPT-BFP48RSSE12	OPT-BFP48RSSE110	36"	¾"	220,000
60" Pan Kit	OPT-BFP60RSS	N/A	N/A	OPT-BFP60RSSE12	OPT-BFP60RSSE110	48"	¾"	385,000



Uniform Gas Flow Generator
- Patented Hub distributes Gas Evenly Throughout The Burner

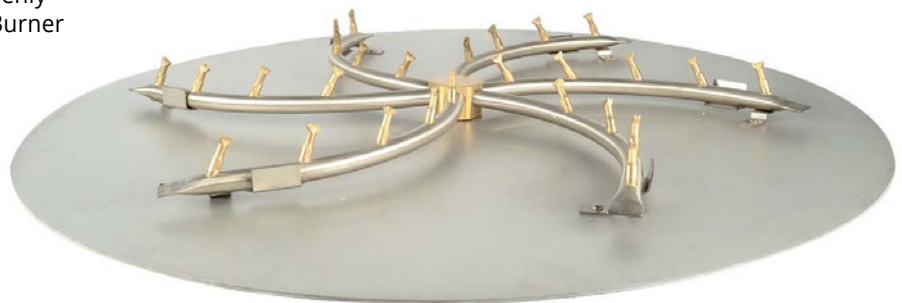

ELECTRONIC IGNITION ACCESSORIES



REMOTE CONTROL & WIRELESS RECEIVER
OPT-RC110V

WEATHERPROOF ON/OFF SWITCH
OPT-WPS110V

110V EMERGENCY STOP BUTTON
OPT-ESTOP

110V 1-HOUR DIAL TIMER
OPT-DTM

GAS ACCESSORIES



GAS TIMER & EMERGENCY STOP
OPT-ESTOPTM

NATURAL GAS KIT
OPT-NGKNG - 0-290K BTU
OPT-NGKNGHC - 291K+ BTU

LIQUID PROPANE KIT
OPT-LPKLP - 0-290K BTU
OPT-LPKLPHC - 291K+ BTU

Low Voltage Ignition

Plug & Play To Low Voltage

Flame Sense



Round Flat Pan & SS Round Bullet Burner®

ITEM	PAN & BURNER ONLY	FLAME SENSE MATCH LIT CERTIFIED	FLAME SENSE W/ SPARK IGNITION	LOW VOLTAGE	PLUG & PLAY TO LOW VOLTAGE	BURNER SIZE	GAS INLET	BTU
18" Pan Kit - A	OPT-BFP18RDSS	OPT-BFP18RDSSFSML	OPT-BFP18RDSSFSEN	OPT-BFP18RDSSE12	OPT-BFP18RDSSE110	8"	½"	65,000
18" Pan Kit - B	OPT-BFP182RDSS	OPT-BFP182RDSSFSML	OPT-BFP182RDSSFSEN	OPT-BFP182RDSSE12	OPT-BFP182RDSSE110	12"	½"	100,000
24" Pan Kit	OPT-BFP24RDSS	OPT-BFP24RDSSFSML	OPT-BFP24RDSSFSEN	OPT-BFP24RDSSE12	OPT-BFP24RDSSE110	18" (2R)	½"	225,000
30" Pan Kit	OPT-BFP30RDSS	N/A	OPT-BFP30RDSSFSEN	OPT-BFP30RDSSE12	OPT-BFP30RDSSE110	24" (2R)	½"	275,000
36" Pan Kit	OPT-BFP36RDSS	N/A	N/A	OPT-BFP36RDSSE12	OPT-BFP36RDSSE110	30" (3R)	¾"	460,000
48" Pan Kit	OPT-BFP48RDSS	N/A	N/A	OPT-BFP48RDSSE12	OPT-BFP48RDSSE110	36" (3R)	¾"	525,000
60" Pan Kit	OPT-BFP60RDSS	N/A	N/A	OPT-BFP60RDSSE12	OPT-BFP60RDSSE110	48" (4R, M)	¾"	850,000



Raised Gas Hub



The Patented Bullet Burner's eliminate the need for an additional LP air mixer. Suitable for either natural gas or liquid propane applications. Electronic ignition systems require 10" clearance below the pan. 110V Ignition System Kits use a 3-prong grounded plug.

BURNER SIZE GUIDE: M = Double Inlet and uses manifold that adds 5" in height below the pan ; 2R = 2 Rings ; 3R = 3 Rings ; 4R = 4 Rings

Low Voltage Ignition



Plug & Play To Low Voltage



Flame Sense



Square Flat Pan & SS Triple S Bullet Burner®

ITEM	PAN & BURNER ONLY	FLAME SENSE MATCH LIT CERTIFIED	FLAME SENSE W/ SPARK IGNITION	LOW VOLTAGE	PLUG & PLAY TO LOW VOLTAGE	BURNER SIZE	GAS INLET	BTU
18" Pan Kit - A	OPT-BFP18SSS	OPT-BFP18SSSFMSL	OPT-BFP18SSSFSEN	OPT-BFP18SSSE12	OPT-BFP18SSSE110	8"	½"	50,000
18" Pan Kit - B	OPT-BFP182SSS	OPT-BFP182SSSFMSL	OPT-BFP182SSSFSEN	OPT-BFP182SSSE12	OPT-BFP182SSSE110	12"	½"	75,000
24" Pan Kit	OPT-BFP24SSS	OPT-BFP24SSSFMSL	OPT-BFP24SSSFSEN	OPT-BFP24SSSE12	OPT-BFP24SSSE110	18"	½"	110,000
30" Pan Kit	OPT-BFP30SSS	N/A	OPT-BFP30SSSFSEN	OPT-BFP30SSSE12	OPT-BFP30SSSE110	24"	½"	145,000
36" Pan Kit	OPT-BFP36SSS	N/A	N/A	OPT-BFP36SSSE12	OPT-BFP36SSSE110	30"	¾"	180,000
48" Pan Kit	OPT-BFP48SSS	N/A	N/A	OPT-BFP48SSSE12	OPT-BFP48SSSE110	36"	¾"	220,000
60" Pan Kit	OPT-BFP60SSS	N/A	N/A	OPT-BFP60SSSE12	OPT-BFP60SSSE110	48"	¾"	385,000



Uniform Gas Flow Generator
- Patented Hub distributes Gas Evenly Throughout The Burner



ELECTRONIC IGNITION ACCESSORIES

GAS ACCESSORIES



Low Voltage Ignition

Plug & Play To Low Voltage

Flame Sense



Square Flat Pan & SS Square Bullet Burner®

ITEM	PAN & BURNER ONLY	FLAME SENSE MATCH LIT CERTIFIED	FLAME SENSE W/ SPARK IGNITION	LOW VOLTAGE	PLUG & PLAY TO LOW VOLTAGE	BURNER SIZE	GAS INLET	BTU
18" Pan Kit - A	OPT-BFP18SQSS	OPT-BFP18SQSSFSML	OPT-BFP18SQSSFSEN	OPT-BFP18SQSSE12	OPT-BFP18SQSSE110	8"	½"	80,000
18" Pan Kit - B	OPT-BFP182SQSS	OPT-BFP182SQSSFSML	OPT-BFP182SQSSFSEN	OPT-BFP182SQSSE12	OPT-BFP182SQSSE110	12"	½"	120,000
24" Pan Kit	OPT-BFP24SQSS	OPT-BFP24SQSSFSML	OPT-BFP24SQSSFSEN	OPT-BFP24SQSSE12	OPT-BFP24SQSSE110	18" (2R)	½"	280,000
30" Pan Kit	OPT-BFP30SQSS	N/A	OPT-BFP30SQSSFSEN	OPT-BFP30SQSSE12	OPT-BFP30SQSSE110	24" (2R)	½"	340,000
36" Pan Kit	OPT-BFP36SQSS	N/A	N/A	OPT-BFP36SQSSE12	OPT-BFP36SQSSE110	30" (3R)	¾"	565,000
48" Pan Kit	OPT-BFP48SQSS	N/A	N/A	OPT-BFP48SQSSE12	OPT-BFP48SQSSE110	36" (3R)	¾"	650,000
60" Pan Kit	OPT-BFP60SQSS	N/A	N/A	OPT-BFP60SQSSE12	OPT-BFP60SQSSE110	48" (4R, M)	¾"	1,060,000



Raised Gas Hub

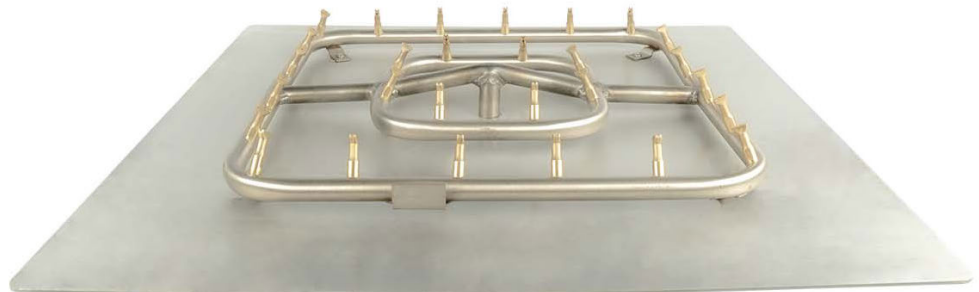

The Patented Bullet Burner's eliminate the need for an additional LP air mixer. Suitable for either natural gas or liquid propane applications. Electronic ignition systems require 10" clearance below the pan. 110V Ignition System Kits use a 3-prong grounded plug.

BURNER SIZE GUIDE: M = Double Inlet and uses manifold that adds 5" in height below the pan ; 2R = 2 Rings ; 3R = 3 Rings ; 4R = 4 Rings

Low Voltage Ignition



Plug & Play To Low Voltage



Flame Sense



Rectangular Flat Pan & SS Linear Bullet Burner®

ITEM	PAN & BURNER ONLY	FLAME SENSE MATCH LIT CERTIFIED	FLAME SENSE W/ SPARK IGNITION	LOW VOLTAGE	PLUG & PLAY TO LOW VOLTAGE	BURNER SIZE	GAS INLET	BTU
24"x8" Pan Kit	OPT-BFP24RTSS	OPT-BFP24RTSSFSML	OPT-BFP24RTSSFSEN	OPT-BFP24RTSSE12	OPT-BFP24RTSSE110	18"	1/2"	40,000
36"x8" Pan Kit	OPT-BFP36RTSS	OPT-BFP36RTSSFSML	OPT-BFP36RTSSFSEN	OPT-BFP36RTSSE12	OPT-BFP36RTSSE110	30"	1/2"	60,000
48"x8" Pan Kit	OPT-BFP48RTSS	OPT-BFP48RTSSFSML	OPT-BFP48RTSSFSEN	OPT-BFP48RTSSE12	OPT-BFP48RTSSE110	42"	1/2"	85,000
60"x8" Pan Kit	OPT-BFP60RTSS	OPT-BFP60RTSSFSML	OPT-BFP60RTSSFSEN	OPT-BFP60RTSSE12	OPT-BFP60RTSSE110	48"	1/2"	100,000
72"x8" Pan Kit	OPT-BFP72RTSS	OPT-BFP72RTSSFSML	OPT-BFP72RTSSFSEN	OPT-BFP72RTSSE12	OPT-BFP72RTSSE110	60"	3/4"	120,000
84"x8" Pan Kit	OPT-BFP84RTSS	N/A	N/A	OPT-BFP84RTSSE12	OPT-BFP84RTSSE110	72"	3/4"	145,000
96"x8" Pan Kit	OPT-BFP96RTSS	N/A	N/A	OPT-BFP96RTSSE12	OPT-BFP96RTSSE110	84"	3/4"	170,000



Raised Gas Hub



ELECTRONIC IGNITION ACCESSORIES

GAS ACCESSORIES



Low Voltage Ignition

Plug & Play To Low Voltage

Flame Sense

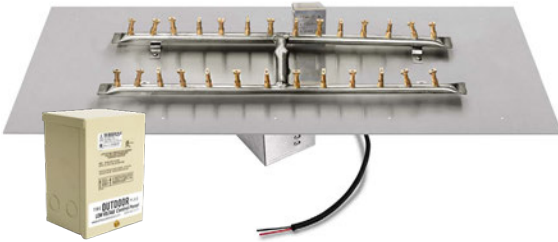

Rectangular Flat Pan & SS 'H' Bullet Burner®

ITEM	PAN & BURNER ONLY	FLAME SENSE MATCH LIT CERTIFIED	FLAME SENSE W/ SPARK IGNITION	LOW VOLTAGE	PLUG & PLAY TO LOW VOLTAGE	BURNER SIZE	GAS INLET	BTU
24"x12" Pan Kit	OPT-BFP1224RSS	OPT-BFP1224RSSFSML	OPT-BFP1224RSSFSEN	OPT-BFP1224RSSE12	OPT-BFP1224RSSE110	18"x6"	½"	85,000
36"x12" Pan Kit	OPT-BFP1236RSS	OPT-BFP1236RSSFSML	OPT-BFP1236RSSFSEN	OPT-BFP1236RSSE12	OPT-BFP1236RSSE110	30"x6"	½"	110,000
48"x12" Pan Kit	OPT-BFP1248RSS	OPT-BFP1248RSSFSML	OPT-BFP1248RSSFSEN	OPT-BFP1248RSSE12	OPT-BFP1248RSSE110	42"x6"	½"	160,000
60"x12" Pan Kit	OPT-BFP1260RSS	N/A	N/A	OPT-BFP1260RSSE12	OPT-BFP1260RSSE110	48"x6"	½"	205,000
72"x12" Pan Kit	OPT-BFP1272RSS	N/A	N/A	OPT-BFP1272RSSE12	OPT-BFP1272RSSE110	60"x6" (M)	¾"	255,000
84"x12" Pan Kit	OPT-BFP1284RSS	N/A	N/A	OPT-BFP1284RSSE12	OPT-BFP1284RSSE110	72"x6" (M)	¾"	300,000
96"x12" Pan Kit	OPT-BFP1296RSS	N/A	N/A	OPT-BFP1296RSSE12	OPT-BFP1296RSSE110	84"x6" (M)	¾"	350,000



Raised Gas Hub

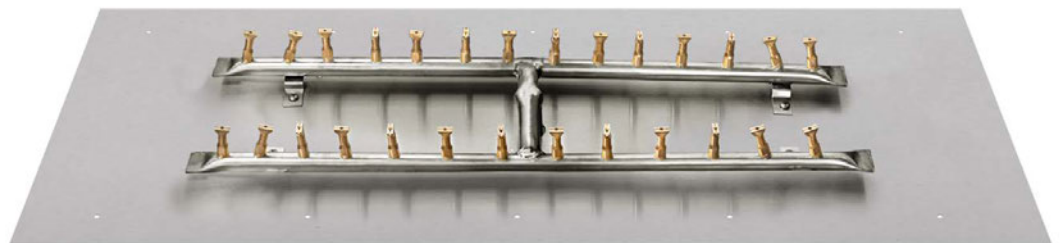

The Patented Bullet Burner's eliminate the need for an additional LP air mixer. Suitable for either natural gas or liquid propane applications. Electronic ignition systems require 10" clearance below the pan. 110V Ignition System Kits use a 3-prong grounded plug.

BURNER SIZE GUIDE: **M** = Double Inlet and uses manifold that adds 5" in height below the pan ; **2R** = 2 Rings ; **3R** = 3 Rings ; **4R** = 4 Rings

Low Voltage Ignition



Plug & Play To Low Voltage



Flame Sense



Rectangular Flat Pan & SS Switchback Bullet Burner®

ITEM	PAN & BURNER ONLY	FLAME SENSE MATCH LIT CERTIFIED	FLAME SENSE W/ SPARK IGNITION	LOW VOLTAGE	PLUG & PLAY TO LOW VOLTAGE	BURNER SIZE	GAS INLET	BTU
24"x12" Pan Kit	OPT-BFP1224SBSS	OPT-BFP1224SBSSFSML	OPT-BFP1224SBSSFSEN	OPT-BFP1224SBSSSE12	OPT-BFP1224SBSSSE110	18"x6"	½"	70,000
36"x12" Pan Kit	OPT-BFP1236SBSS	OPT-BFP1236SBSSFSML	OPT-BFP1236SBSSFSEN	OPT-BFP1236SBSSSE12	OPT-BFP1236SBSSSE110	30"x6"	½"	90,000
48"x12" Pan Kit	OPT-BFP1248SBSS	OPT-BFP1248SBSSFSML	OPT-BFP1248SBSSFSEN	OPT-BFP1248SBSSSE12	OPT-BFP1248SBSSSE110	42"x6"	½"	145,000
60"x12" Pan Kit	OPT-BFP1260SBSS	N/A	N/A	OPT-BFP1260SBSSSE12	OPT-BFP1260SBSSSE110	48"x6"	½"	165,000
72"x12" Pan Kit	OPT-BFP1272SBSS	N/A	N/A	OPT-BFP1272SBSSSE12	OPT-BFP1272SBSSSE110	60"x6" (M)	¾"	200,000
84"x12" Pan Kit	OPT-BFP1284SBSS	N/A	N/A	OPT-BFP1284SBSSSE12	OPT-BFP1284SBSSSE110	72"x6" (M)	¾"	240,000
96"x12" Pan Kit	OPT-BFP1296SBSS	N/A	N/A	OPT-BFP1296SBSSSE12	OPT-BFP1296SBSSSE110	84"x6" (M)	¾"	360,000



Raised Gas Hub



ELECTRONIC IGNITION ACCESSORIES

REMOTE CONTROL & WIRELESS RECEIVER OPT-RC110V	WEATHERPROOF ON/OFF SWITCH OPT-WPS110V	110V EMERGENCY STOP BUTTON OPT-ESTOP	110V 1-HOUR DIAL TIMER OPT-DTM

GAS ACCESSORIES

GAS TIMER & EMERGENCY STOP OPT-ESTOPTM	NATURAL GAS KIT OPT-NGKNG - 0-290K BTU OPT-NGKNGHC - 291K+ BTU	LIQUID PROPANE KIT OPT-LPKLP - 0-290K BTU OPT-LPKLPHC - 291K+ BTU

The Patented Bullet Burner's eliminate the need for an additional LP air mixer. Suitable for either natural gas or liquid propane applications. Pans have 1" Lip & 2.5" Height. Electronic ignition requires 10" clearance below the pan. 110V Ignition System Kits use a 3-prong grounded plug.

BURNER SIZE GUIDE: **M** = Double Inlet and uses manifold that adds 5" in height below the pan ; **2R** = 2 Rings ; **3R** = 3 Rings ; **4R** = 4 Rings

Low Voltage Ignition



Plug & Play To Low Voltage



Flame Sense



Round Drop In & SS Triple S Bullet Burner®

ITEM	PAN & BURNER ONLY	FLAME SENSE MATCH LIT CERTIFIED	FLAME SENSE W/ SPARK IGNITION	LOW VOLTAGE	PLUG & PLAY TO LOW VOLTAGE	BURNER SIZE	GAS INLET	BTU
13" Pan Kit	OPT-BP13RDSS	OPT-BP13RDSSFML	OPT-BP13RDSSFEN	OPT-BP13RDSSE12	OPT-BP13RDSSE110	8"	½"	50,000
19" Pan Kit	OPT-BP19RDSS	OPT-BP19RDSSFML	OPT-BP19RDSSFEN	OPT-BP19RDSSE12	OPT-BP19RDSSE110	12"	½"	75,000
25" Pan Kit	OPT-BP25RDSS	OPT-BP25RDSSFML	OPT-BP25RDSSFEN	OPT-BP25RDSSE12	OPT-BP25RDSSE110	18"	½"	110,000
31" Pan Kit	OPT-BP31RDSS	N/A	N/A	OPT-BP31RDSSE12	OPT-BP31RDSSE110	24"	½"	145,000
37" Pan Kit	OPT-BP37RDSS	N/A	N/A	OPT-BP37RDSSE12	OPT-BP37RDSSE110	30"	¾"	180,000
43" Pan Kit	OPT-BP43RDSS	N/A	N/A	OPT-BP43RDSSE12	OPT-BP43RDSSE110	36"	¾"	220,000



**1" Flange
2" Depth**



Uniform Gas Flow Generator
 - Patented Hub distributes Gas Evenly Throughout The Burner



Low Voltage Ignition

Plug & Play To Low Voltage

Flame Sense



Flame Sense w/ Spark Ignition

Round Drop In & SS Round Bullet Burner®

ITEM	PAN & BURNER ONLY	FLAME SENSE MATCH LIT CERTIFIED	FLAME SENSE W/ SPARK IGNITION	LOW VOLTAGE	PLUG & PLAY TO LOW VOLTAGE	BURNER SIZE	GAS INLET	BTU
13" Pan Kit	OPT-BP13RRSS	OPT-BP13RRSSFML	OPT-BP13RRSSFSEN	OPT-BP13RRSSE12	OPT-BP13RRSSE110	8"	½"	65,000
19" Pan Kit	OPT-BP19RRSS	OPT-BP19RRSSFML	OPT-BP19RRSSFSEN	OPT-BP19RRSSE12	OPT-BP19RRSSE110	12"	½"	100,000
25" Pan Kit	OPT-BP25RRSS	OPT-BP25RRSSFML	OPT-BP25RRSSFSEN	OPT-BP25RRSSE12	OPT-BP25RRSSE110	18" (2R)	½"	225,000
31" Pan Kit	OPT-BP31RRSS	N/A	N/A	OPT-BP31RRSSE12	OPT-BP31RRSSE110	24" (2R)	½"	275,000
37" Pan Kit	OPT-BP37RRSS	N/A	N/A	OPT-BP37RRSSE12	OPT-BP37RRSSE110	30" (3R)	¾"	460,000
43" Pan Kit	OPT-BP43RRSS	N/A	N/A	OPT-BP43RRSSE12	OPT-BP43RRSSE110	36" (3R)	¾"	525,000

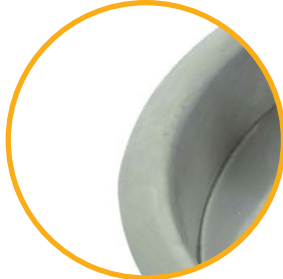

1" Flange
2" Depth



Raised Gas Hub



ELECTRONIC IGNITION ACCESSORIES

GAS ACCESSORIES



DROP-IN PAN & SS BULLET BURNER® KITS

PATENTED DESIGN



The Patented Bullet Burner's eliminate the need for an additional LP air mixer. Suitable for either natural gas or liquid propane applications. Pans have 1" Lip & 2.5" Height. Electronic ignition requires 10" clearance below the pan. 110V Ignition System Kits use a 3-prong grounded plug.

BURNER SIZE GUIDE: M = Double Inlet and uses manifold that adds 5" in height below the pan ; 2R = 2 Rings ; 3R = 3 Rings ; 4R = 4 Rings

Low Voltage Ignition

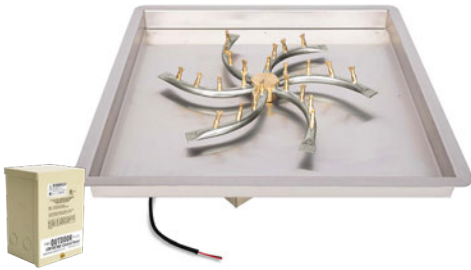

Plug & Play To Low Voltage



Flame Sense



Square Drop In & SS Triple S Bullet Burner®

ITEM	PAN & BURNER ONLY	FLAME SENSE MATCH LIT CERTIFIED	FLAME SENSE W/ SPARK IGNITION	LOW VOLTAGE	PLUG & PLAY TO LOW VOLTAGE	BURNER SIZE	GAS INLET	BTU
12" Pan Kit	OPT-BP12SDSS	OPT-BP12SDSSFML	OPT-BP12SDSSFSEN	OPT-BP12SDSSE12	OPT-BP12SDSSE110	8"	½"	50,000
18" Pan Kit	OPT-BP18SDSS	OPT-BP18SDSSFML	OPT-BP18SDSSFSEN	OPT-BP18SDSSE12	OPT-BP18SDSSE110	12"	½"	75,000
24" Pan Kit	OPT-BP24SDSS	OPT-BP24SDSSFML	OPT-BP24SDSSFSEN	OPT-BP24SDSSE12	OPT-BP24SDSSE110	18"	½"	110,000
30" Pan Kit	OPT-BP30SDSS	N/A	OPT-BP30SDSSFSEN	OPT-BP30SDSSE12	OPT-BP30SDSSE110	24"	½"	145,000
36" Pan Kit	OPT-BP36SDSS	N/A	N/A	OPT-BP36SDSSE12	OPT-BP36SDSSE110	30"	¾"	180,000
48" Pan Kit	OPT-BP48SDSS	N/A	N/A	OPT-BP48SDSSE12	OPT-BP48SDSSE110	36"	¾"	220,000



**1" Flange
2.5" Depth**



Uniform Gas Flow Generator
- Patented Hub distributes Gas Evenly Throughout The Burner



Low Voltage Ignition

Plug & Play To Low Voltage

Flame Sense



Square Drop In & SS Square Bullet Burner®

ITEM	PAN & BURNER ONLY	FLAME SENSE MATCH LIT CERTIFIED	FLAME SENSE W/ SPARK IGNITION	LOW VOLTAGE	PLUG & PLAY TO LOW VOLTAGE	BURNER SIZE	GAS INLET	BTU
12" Pan Kit	OPT-BP12SQDSS	OPT-BP12SQDSSFSML	OPT-BP12SQDSSFSEN	OPT-BP12SQDSSE12	OPT-BP12SQDSSE110	8"	½"	80,000
18" Pan Kit	OPT-BP18SQDSS	OPT-BP18SQDSSFSML	OPT-BP18SQDSSFSEN	OPT-BP18SQDSSE12	OPT-BP18SQDSSE110	12"	½"	120,000
24" Pan Kit	OPT-BP24SQDSS	OPT-BP24SQDSSFSML	OPT-BP24SQDSSFSEN	OPT-BP24SQDSSE12	OPT-BP24SQDSSE110	18" (2R)	½"	280,000
30" Pan Kit	OPT-BP30SQDSS	N/A	OPT-BP30SQDSSFSEN	OPT-BP30SQDSSE12	OPT-BP30SQDSSE110	24" (2R)	½"	340,000
36" Pan Kit	OPT-BP36SQDSS	N/A	N/A	OPT-BP36SQDSSE12	OPT-BP36SQDSSE110	30" (3R)	¾"	565,000
48" Pan Kit	OPT-BP48SQDSS	N/A	N/A	OPT-BP48SQDSSE12	OPT-BP48SQDSSE110	36" (3R)	¾"	650,000



**1" Flange
2.5" Depth**

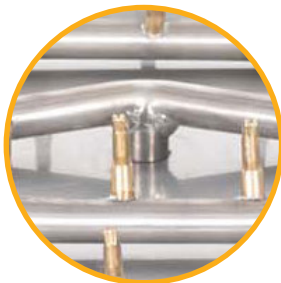

Raised Gas Hub



ELECTRONIC IGNITION ACCESSORIES



GAS ACCESSORIES



The Patented Bullet Burner's eliminate the need for an additional LP air mixer. Suitable for either natural gas or liquid propane applications. Pans have 1" Lip & 2.5" Height. Electronic ignition requires 10" clearance below the pan. 110V Ignition System Kits use a 3-prong grounded plug.

BURNER SIZE GUIDE: **M** = Double Inlet and uses manifold that adds 5" in height below the pan ; **2R** = 2 Rings ; **3R** = 3 Rings ; **4R** = 4 Rings

Low Voltage Ignition

Plug & Play To Low Voltage

Flame Sense



Rectangular Drop In & SS Linear Bullet Burner®

ITEM	PAN & BURNER ONLY	FLAME SENSE MATCH LIT CERTIFIED	FLAME SENSE W/ SPARK IGNITION	LOW VOLTAGE	PLUG & PLAY TO LOW VOLTAGE	BURNER SIZE	GAS INLET	BTU
24"x8" Pan Kit	OPT-BP824RDSS	OPT-BP824RDSSFSML	OPT-BP824RDSSFSEN	OPT-BP824RDSSE12	OPT-BP824RDSSE110	18"	½"	40,000
36"x8" Pan Kit	OPT-BP836RDSS	OPT-BP836RDSSFSML	OPT-BP836RDSSFSEN	OPT-BP836RDSSE12	OPT-BP836RDSSE110	30"	½"	60,000
48"x8" Pan Kit	OPT-BP848RDSS	OPT-BP848RDSSFSML	OPT-BP848RDSSFSEN	OPT-BP848RDSSE12	OPT-BP848RDSSE110	42"	½"	85,000
60"x8" Pan Kit	OPT-BP860RDSS	OPT-BP860RDSSFSML	OPT-BP860RDSSFSEN	OPT-BP860RDSSE12	OPT-BP860RDSSE110	48"	½"	100,000
72"x8" Pan Kit	OPT-BP872RDSS	OPT-BP872RDSSFSML	OPT-BP872RDSSFSEN	OPT-BP872RDSSE12	OPT-BP872RDSSE110	60"	¾"	120,000
84"x8" Pan Kit	OPT-BP884RDSS	N/A	N/A	OPT-BP884RDSSE12	OPT-BP884RDSSE110	72"	¾"	145,000
96"x8" Pan Kit	OPT-BP896RDSS	N/A	N/A	OPT-BP896RDSSE12	OPT-BP896RDSSE110	84"	¾"	170,000



**1" Flange
2.5" Depth**



Raised Gas Hub



Low Voltage Ignition

Plug & Play To Low Voltage

Flame Sense

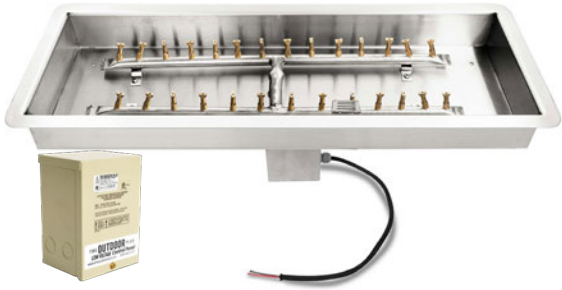

Flame Sense w/ Spark Ignition

Rectangular Drop In & SS 'H' Bullet Burner®

ITEM	PAN & BURNER ONLY	FLAME SENSE MATCH LIT CERTIFIED	FLAME SENSE W/ SPARK IGNITION	LOW VOLTAGE	PLUG & PLAY TO LOW VOLTAGE	BURNER SIZE	GAS INLET	BTU
24"x12" Pan Kit	OPT-BP1224RDSS	OPT-BP1224RDSSFSML	OPT-BP1224RDSSFSEN	OPT-BP1224RDSSE12	OPT-BP1224RDSSE110	18"x6"	½"	85,000
36"x12" Pan Kit	OPT-BP1236RDSS	OPT-BP1236RDSSFSML	OPT-BP1236RDSSFSEN	OPT-BP1236RDSSE12	OPT-BP1236RDSSE110	24"x6"	½"	110,000
48"x12" Pan Kit	OPT-BP1248RDSS	OPT-BP1248RDSSFSML	OPT-BP1248RDSSFSEN	OPT-BP1248RDSSE12	OPT-BP1248RDSSE110	42"x6"	½"	180,000
60"x12" Pan Kit	OPT-BP1260RDSS	N/A	N/A	OPT-BP1260RDSSE12	OPT-BP1260RDSSE110	48"x6"	½"	205,000
72"x12" Pan Kit	OPT-BP1272RDSS	N/A	N/A	OPT-BP1272RDSSE12	OPT-BP1272RDSSE110	60"x6" (M)	¾"	255,000
84"x12" Pan Kit	OPT-BP1284RDSS	N/A	N/A	OPT-BP1284RDSSE12	OPT-BP1284RDSSE110	72"x6" (M)	¾"	300,000
96"x12" Pan Kit	OPT-BP1296RDSS	N/A	N/A	OPT-BP1296RDSSE12	OPT-BP1296RDSSE110	84"x6" (M)	¾"	350,000



1" Flange
2.5" Depth



Raised Gas Hub



ELECTRONIC IGNITION ACCESSORIES



GAS ACCESSORIES



Low Voltage Ignition

Plug & Play To Low Voltage

Flame Sense



Rectangular Drop In & SS Switchback Bullet Burner®

ITEM	PAN & BURNER ONLY	FLAME SENSE MATCH LIT CERTIFIED	FLAME SENSE W/ SPARK IGNITION	LOW VOLTAGE	PLUG & PLAY TO LOW VOLTAGE	BURNER SIZE	GAS INLET	BTU
24"x12" Pan Kit	OPT-BP1224SBDSS	OPT-BP1224SBDSSFML	OPT-BP1224SBDSSFSEN	OPT-BP1224SBDSSSE12	OPT-BP1224SBDSSSE110	18"x6"	1/2"	70,000
36"x12" Pan Kit	OPT-BP1236SBDSS	OPT-BP1236SBDSSFML	OPT-BP1236SBDSSFSEN	OPT-BP1236SBDSSSE12	OPT-BP1236SBDSSSE110	30"x6"	1/2"	90,000
48"x12" Pan Kit	OPT-BP1248SBDSS	OPT-BP1248SBDSSFML	OPT-BP1248SBDSSFSEN	OPT-BP1248SBDSSSE12	OPT-BP1248SBDSSSE110	42"x6"	1/2"	145,000
60"x12" Pan Kit	OPT-BP1260SBDSS	N/A	N/A	OPT-BP1260SBDSSSE12	OPT-BP1260SBDSSSE110	48"x6"	1/2"	165,000
72"x12" Pan Kit	OPT-BP1272SBDSS	N/A	N/A	OPT-BP1272SBDSSSE12	OPT-BP1272SBDSSSE110	60"x6" (M)	3/4"	200,000
84"x12" Pan Kit	OPT-BP1284SBDSS	N/A	N/A	OPT-BP1284SBDSSSE12	OPT-BP1284SBDSSSE110	72"x6" (M)	3/4"	240,000
96"x12" Pan Kit	OPT-BP1296SBDSS	N/A	N/A	OPT-BP1296SBDSSSE12	OPT-BP1296SBDSSSE110	84"x6" (M)	3/4"	360,000

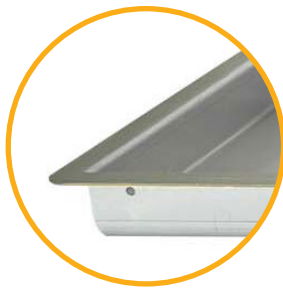

**1" Flange
2.5" Depth**

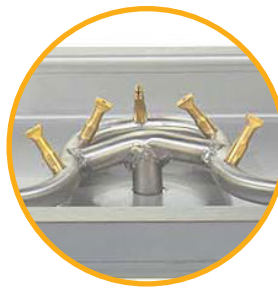

Raised Gas Hub



ELECTRONIC IGNITION ACCESSORIES



GAS ACCESSORIES



MORE FLAME, LESS GAS®

THE OUTDOOR PLUS BURNERS

Works with LP or NG

All of TOP's burners are suitable for any fire pit or fire bowl whether they are natural gas or liquid propane

Water Runoff Protection

The inlets on all TOP burners are raised and tapered so that if water does enter the burner, it will not enter the gas line.

Multiple Drain Holes

Each burner has multiple drain holes to release any water that may enter the burner through the flame holes.

Drain Hole Tab

With the The drain holes pointed to the side, we add a tab to redirect the flame upward to retain the intended flame pattern. Other burners have drain holes which create an unappealing flame

.065 Wall Thickness & Stainless Steel Construction

The wall thickness of T.O.P.'s stainless steel burners is greater than most burners on the market. Along with the 304 stainless steel construction. This ensures a long burner life and resists warping.

Individually Drilled Holes

Improved flame pattern and gas flow compared to punched holes

Downward Taper

The Downward taper prevents water from traveling up the cross member and entering the gas line.

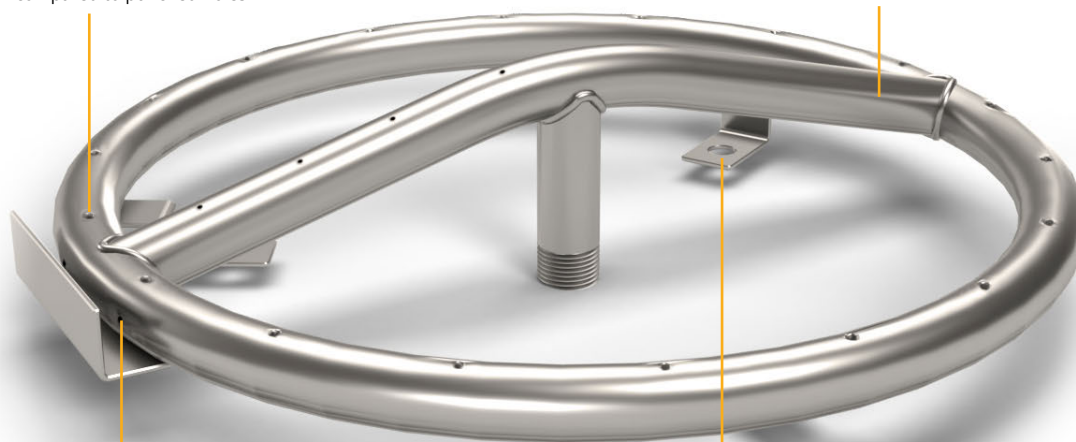

Drain Holes on Side

Prevents water from building up inside the burner and potentially entering the gas line

Manufactured By Hand

This ensures that each burner is inspected by multiple people along the assembly line and meets T.O.P.'s high quality standards

Anchoring Tabs

These tabs come with every burner to give you the option to anchor it onto the fire pan.

Using Propane? Make Sure You Use an LP Air Mix Orifice

Compared to Natural Gas (NG), Propane Gas (LP) is much more volatile and requires more oxygen for combustion.

Because of this, an air mixer is installed under the burner to lean out the gas, and minimize propane soot.

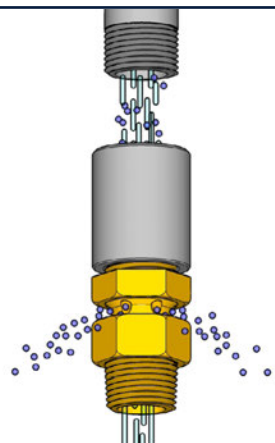

All Outdoor Plus Kits Come With Orifices

All of T.O.P.'s burner kits & fire pits include an orifice which helps regulate & save gas.

The LP air mix orifice includes an adjustable nut to control the amount of air that is mixed with the gas



LP ORIFICE

NG ORIFICE

FLAT PAN & SS BURNER KITS



Suitable for either natural gas or liquid propane applications. Electronic ignition systems require 10" clearance below the pan. 110V Ignition System Kits use a 3-prong grounded plug.

BURNER SIZE GUIDE: M = Double Inlet and uses manifold that adds 5" in height below the pan ; 2R = 2 Rings ; 3R = 3 Rings ; 4R = 4 Rings

Low Voltage Ignition



Plug & Play To Low Voltage



Flame Sense



Round Flat Pan & Round SS Burner

ITEM	PAN & BURNER ONLY	FLAME SENSE MATCH LIT CERTIFIED	FLAME SENSE W/ SPARK IGNITION	LOW VOLTAGE	PLUG & PLAY TO LOW VOLTAGE	BURNER SIZE	GAS INLET	BTU
12" Pan Kit	OPT-110012BP	OPT-110012BPFMSL	OPT-110012BPFSEN	OPT-110012BPE12	OPT-110012BPE110	6"	½"	35,000
18" Pan Kit	OPT-110018BP	OPT-110018BPFMSL	OPT-110018BPFSEN	OPT-110018BPE12	OPT-110018BPE110	12"	½"	65,000
24" Pan Kit	OPT-110024BP	OPT-110024BPFMSL	OPT-110024BPFSEN	OPT-110024BPE12	OPT-110024BPE110	18" (2R)	½"	160,000
30" Pan Kit	OPT-110030BP	N/A	OPT-110030BPFSEN	OPT-110030BPE12	OPT-110030BPE110	24" (2R)	½"	190,000
36" Pan Kit	OPT-110036BP	N/A	N/A	OPT-110036BPE12	OPT-110036BPE110	30" (3R)	¾"	330,000
42" Pan Kit	OPT-110042BP	N/A	N/A	OPT-110042BPE12	OPT-110042BPE110	36" (3R)	¾"	380,000
48" Pan Kit	OPT-110048BP	N/A	N/A	OPT-110048BPE12	OPT-110048BPE110	36" (3R)	¾"	380,000



Raised Gas Hub



FLAT PAN & STAINLESS STEEL BURNER KITS

Low Voltage Ignition

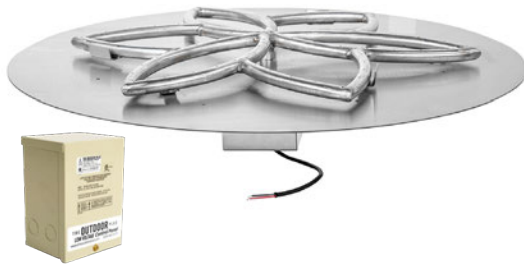

Plug & Play To Low Voltage



Flame Sense



Round Flat Pan & SS Lotus Burner

ITEM	PAN & BURNER ONLY	FLAME SENSE MATCH LIT CERTIFIED	FLAME SENSE W/ SPARK IGNITION	LOW VOLTAGE	PLUG & PLAY TO LOW VOLTAGE	BURNER SIZE	GAS INLET	BTU
18" Pan Kit	OPT-FRLB18	OPT-FRLB18FSML	OPT-FRLB18FSEN	OPT-FRLB18E12	OPT-FRLB18E110	12"	½"	60,000
24" Pan Kit	OPT-FRLB24	OPT-FRLB24FSML	OPT-FRLB24FSEN	OPT-FRLB24E12	OPT-FRLB24E110	18"	½"	120,000
30" Pan Kit	OPT-FRLB30	N/A	OPT-FRLB30FSEN	OPT-FRLB30E12	OPT-FRLB30E110	24"	½"	190,000
36" Pan Kit	OPT-FRLB36	N/A	N/A	OPT-FRLB36E12	OPT-FRLB36E110	30"	½"	260,000
42" Pan Kit	OPT-FRLB42	N/A	N/A	OPT-FRLB42E12	OPT-FRLB42E110	36"	¾"	340,000
48" Pan Kit	OPT-FRLB48	N/A	N/A	OPT-FRLB48E12	OPT-FRLB48E110	36"	¾"	340,000



Raised Gas Hub

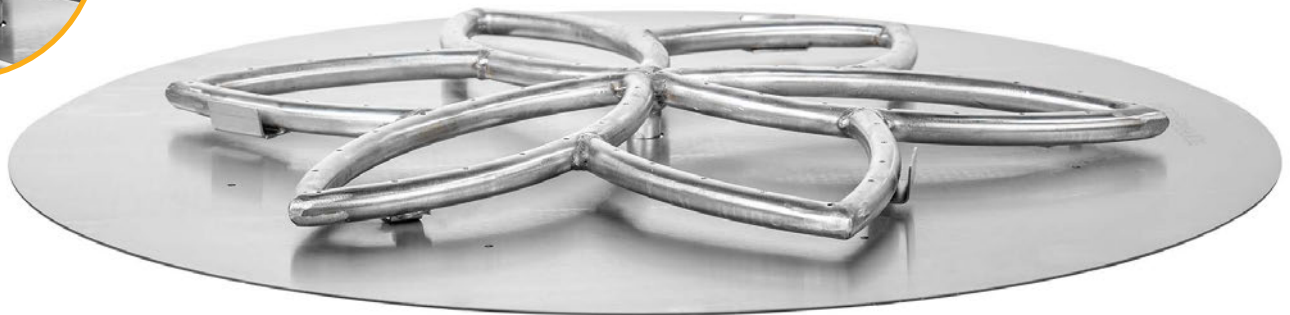

ELECTRONIC IGNITION ACCESSORIES



GAS ACCESSORIES



FLAT PAN & STAINLESS STEEL BURNER KITS



Suitable for either natural gas or liquid propane applications. Electronic ignition systems require 10" clearance below the pan. 110V Ignition System Kits use a 3-prong grounded plug.

BURNER SIZE GUIDE: **M** = Double Inlet and uses manifold that adds 5" in height below the pan ; **2R** = 2 Rings ; **3R** = 3 Rings ; **4R** = 4 Rings

Low Voltage Ignition



Plug & Play To Low Voltage



Flame Sense



Square Flat Pan & Square SS Burner

ITEM	PAN & BURNER ONLY	FLAME SENSE MATCH LIT CERTIFIED	FLAME SENSE W/ SPARK IGNITION	LOW VOLTAGE	PLUG & PLAY TO LOW VOLTAGE	BURNER SIZE	GAS INLET	BTU
16.5" Pan Kit	OPT-999BP16	OPT-999BP16FSML	OPT-999BP16FSEN	OPT-999BP16E12	OPT-999BP16E110	12"	½"	80,000
18" Pan Kit	OPT-999BP18	OPT-999BP18FSML	OPT-999BP18FSEN	OPT-999BP18E12	OPT-999BP18E110	12"	½"	80,000
24" Pan Kit	OPT-999BP24	OPT-999BP24FSML	OPT-999BP24FSEN	OPT-999BP24E12	OPT-999BP24E110	18" (2R)	½"	200,000
30" Pan Kit	OPT-999BP30	N/A	OPT-999BP30FSEN	OPT-999BP30E12	OPT-999BP30E110	24" (2R)	½"	240,000
36" Pan Kit	OPT-999BP36	N/A	N/A	OPT-999BP36E12	OPT-999BP36E110	30" (3R)	¾"	420,000
48" Pan Kit	OPT-999BP48	N/A	N/A	OPT-999BP48E12	OPT-999BP48E110	36" (3R)	¾"	480,000

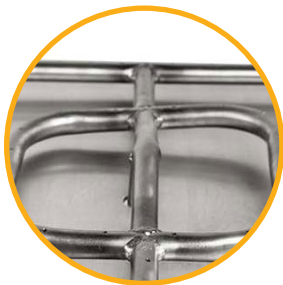

Raised Ga. Hub



FLAT PAN & STAINLESS STEEL BURNER KITS

Low Voltage Ignition

Plug & Play To Low Voltage

Flame Sense

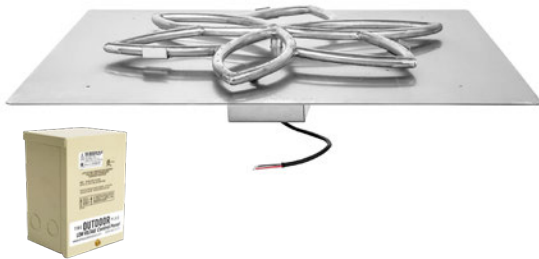

Square Flat Pan & SS Lotus Burner

ITEM	PAN & BURNER ONLY	FLAME SENSE MATCH LIT CERTIFIED	FLAME SENSE W/ SPARK IGNITION	LOW VOLTAGE	PLUG & PLAY TO LOW VOLTAGE	BURNER SIZE	GAS INLET	BTU
16.5" Pan Kit	OPT-FSLB16	OPT-FSLB16FSML	OPT-FSLB16FSEN	OPT-FSLB16E12	OPT-FSLB16E110	12"	½"	90,000
18" Pan Kit	OPT-FSLB18	OPT-FSLB18FSML	OPT-FSLB18FSEN	OPT-FSLB18E12	OPT-FSLB18E110	12"	½"	90,000
24" Pan Kit	OPT-FSLB24	OPT-FSLB24FSML	OPT-FSLB24FSEN	OPT-FSLB24E12	OPT-FSLB24E110	18"	½"	115,000
30" Pan Kit	OPT-FSLB30	N/A	OPT-FSLB30FSEN	OPT-FSLB30E12	OPT-FSLB30E110	24"	½"	175,000
36" Pan Kit	OPT-FSLB36	N/A	N/A	OPT-FSLB36E12	OPT-FSLB36E110	30"	½"	220,000
48" Pan Kit	OPT-FSLB48	N/A	N/A	OPT-FSLB48E12	OPT-FSLB48E110	36"	¾"	265,000



Raised Gas Hub



ELECTRONIC IGNITION ACCESSORIES

GAS ACCESSORIES



REMOTE CONTROL & WIRELESS RECEIVER
OPT-RC110V



WEATHERPROOF ON/OFF SWITCH
OPT-WPS110V



110V EMERGENCY STOP BUTTON
OPT-ESTOP



110V 1-HOUR DIAL TIMER
OPT-DTM



GAS TIMER & EMERGENCY STOP
OPT-ESTOPTM



NATURAL GAS KIT
OPT-NGKNG - 0-290K BTU
OPT-NGKNGHC - 291K+ BTU



LIQUID PROPANE KIT
OPT-LPKLP - 0-290K BTU
OPT-LPKLPHC - 291K+ BTU

FLAT PAN & STAINLESS STEEL BURNER KITS



Suitable for either natural gas or liquid propane applications. Electronic ignition systems require 10" clearance below the pan. 110V Ignition System Kits use a 3-prong grounded plug.

BURNER SIZE GUIDE: **M** = Double Inlet and uses manifold that adds 5" in height below the pan ; **2R** = 2 Rings ; **3R** = 3 Rings ; **4R** = 4 Rings

Low Voltage Ignition

Plug & Play To Low Voltage

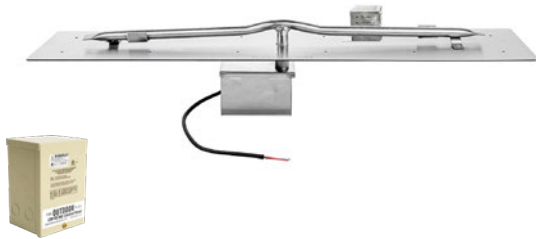

Flame Sense



Rectangular Flat Pan & SS Linear Burner

ITEM	PAN & BURNER ONLY	FLAME SENSE MATCH LIT CERTIFIED	FLAME SENSE IGNITION	LOW VOLTAGE	PLUG & PLAY TO LOW VOLTAGE	BURNER SIZE	GAS INLET	BTU
24" x 6" Pan Kit	OPT-REFS624	OPT-REFS624FSML	OPT-REFS624FSEN	OPT-REFS624E12	OPT-REFS624E110	18"	½"	30,000
30" x 6" Pan Kit	OPT-REFS630	OPT-REFS630FSML	OPT-REFS630FSEN	OPT-REFS630E12	OPT-REFS630E110	24"	½"	40,000
36" x 6" Pan Kit	OPT-REFS636	OPT-REFS636FSML	OPT-REFS636FSEN	OPT-REFS636E12	OPT-REFS636E110	30"	½"	50,000
42" x 6" Pan Kit	OPT-REFS642	OPT-REFS642FSML	OPT-REFS642FSEN	OPT-REFS642E12	OPT-REFS642E110	36"	½"	60,000
48" x 6" Pan Kit	OPT-REFS648	OPT-REFS648FSML	OPT-REFS648FSEN	OPT-REFS648E12	OPT-REFS648E110	42"	½"	70,000
60" x 6" Pan Kit	OPT-REFS660	OPT-REFS660FSML	OPT-REFS660FSEN	OPT-REFS660E12	OPT-REFS660E110	48"	½"	80,000
72" x 6" Pan Kit	OPT-REFS672	OPT-REFS672FSML	OPT-REFS672FSEN	OPT-REFS672E12	OPT-REFS672E110	60"	¾"	100,000
84" x 6" Pan Kit	OPT-REFS684	N/A	N/A	OPT-REFS684E12	OPT-REFS684E110	72"	¾"	120,000
96" x 6" Pan Kit	OPT-REFS696	N/A	N/A	OPT-REFS696E12	OPT-REFS696E110	84"	¾"	140,000
24" x 8" Pan Kit	OPT-REFS824	OPT-REFS824FSML	OPT-REFS824FSEN	OPT-REFS824E12	OPT-REFS824E110	18"	½"	30,000
30" x 8" Pan Kit	OPT-REFS830	OPT-REFS830FSML	OPT-REFS830FSEN	OPT-REFS830E12	OPT-REFS830E110	24"	½"	40,000
36" x 8" Pan Kit	OPT-REFS836	OPT-REFS836FSML	OPT-REFS836FSEN	OPT-REFS836E12	OPT-REFS836E110	30"	½"	50,000
42" x 8" Pan Kit	OPT-REFS842	OPT-REFS842FSML	OPT-REFS842FSEN	OPT-REFS842E12	OPT-REFS842E110	36"	½"	60,000
48" x 8" Pan Kit	OPT-REFS848	OPT-REFS848FSML	OPT-REFS848FSEN	OPT-REFS848E12	OPT-REFS848E110	42"	½"	70,000
60" x 8" Pan Kit	OPT-REFS860	OPT-REFS860FSML	OPT-REFS860FSEN	OPT-REFS860E12	OPT-REFS860E110	48"	½"	80,000
72" x 8" Pan Kit	OPT-REFS872	OPT-REFS872FSML	OPT-REFS872FSEN	OPT-REFS872E12	OPT-REFS872E110	60"	¾"	100,000
84" x 8" Pan Kit	OPT-REFS884	N/A	N/A	OPT-REFS884E12	OPT-REFS884E110	72"	¾"	120,000
96" x 8" Pan Kit	OPT-REFS896	N/A	N/A	OPT-REFS896E12	OPT-REFS896E110	84"	¾"	140,000



Raised Gas Hub



MORE FLAME, LESS GAS®

Proudly Made In The USA 31

FLAT PAN & STAINLESS STEEL BURNER KITS

Low Voltage Ignition

Plug & Play To Low Voltage

Flame Sense



Rectangular Flat Pan & SS 'H' Burner

ITEM	PAN & BURNER ONLY	FLAME SENSE MATCH LIT CERTIFIED	FLAME SENSE IGNITION	LOW VOLTAGE	PLUG & PLAY TO LOW VOLTAGE	BURNER SIZE	GAS INLET	BTU
24" x 12" Pan Kit	OPT-REFD1224	OPT-REFD1224FSML	OPT-REFD1224FSEN	OPT-REFD1224E12	OPT-REFD1224E110	18" x 6"	1/2"	70,000
30" x 12" Pan Kit	OPT-REFD1230	OPT-REFD1230FSML	OPT-REFD1230FSEN	OPT-REFD1230E12	OPT-REFD1230E110	24" x 6"	1/2"	90,000
36" x 12" Pan Kit	OPT-REFD1236	OPT-REFD1236FSML	OPT-REFD1236FSEN	OPT-REFD1236E12	OPT-REFD1236E110	30" x 6"	1/2"	110,000
42" x 12" Pan Kit	OPT-REFD1242	OPT-REFD1242FSML	OPT-REFD1242FSEN	OPT-REFD1242E12	OPT-REFD1242E110	36" x 6"	1/2"	130,000
48" x 12" Pan Kit	OPT-REFD1248	N/A	N/A	OPT-REFD1248E12	OPT-REFD1248E110	42" x 6"	1/2"	150,000
60" x 12" Pan Kit	OPT-REFD1260	N/A	N/A	OPT-REFD1260E12	OPT-REFD1260E110	48" x 6"	1/2"	170,000
72" x 12" Pan Kit	OPT-REFD1272	N/A	N/A	OPT-REFD1272E12	OPT-REFD1272E110	60" x 6" (M)	3/4"	210,000
84" x 12" Pan Kit	OPT-REFD1284	N/A	N/A	OPT-REFD1284E12	OPT-REFD1284E110	72" x 6" (M)	3/4"	250,000
96" x 12" Pan Kit	OPT-REFD1296	N/A	N/A	OPT-REFD1296E12	OPT-REFD1296E110	84" x 6" (M)	3/4"	290,000
24" x 18" Pan Kit	OPT-REFD1824	OPT-REFD1824FSML	OPT-REFD1824FSEN	OPT-REFD1824E12	OPT-REFD1824E110	18" x 12"	1/2"	80,000
30" x 18" Pan Kit	OPT-REFD1830	OPT-REFD1830FSML	OPT-REFD1830FSEN	OPT-REFD1830E12	OPT-REFD1830E110	24" x 12"	1/2"	100,000
36" x 18" Pan Kit	OPT-REFD1836	OPT-REFD1836FSML	OPT-REFD1836FSEN	OPT-REFD1836E12	OPT-REFD1836E110	30" x 12"	1/2"	120,000
42" x 18" Pan Kit	OPT-REFD1842	OPT-REFD1842FSML	OPT-REFD1842FSEN	OPT-REFD1842E12	OPT-REFD1842E110	36" x 12"	1/2"	140,000
48" x 18" Pan Kit	OPT-REFD1848	N/A	N/A	OPT-REFD1848E12	OPT-REFD1848E110	42" x 12"	1/2"	160,000
60" x 18" Pan Kit	OPT-REFD1860	N/A	N/A	OPT-REFD1860E12	OPT-REFD1860E110	48" x 12"	1/2"	180,000
72" x 18" Pan Kit	OPT-REFD1872	N/A	N/A	OPT-REFD1872E12	OPT-REFD1872E110	60" x 12" (M)	3/4"	220,000
84" x 18" Pan Kit	OPT-REFD1884	N/A	N/A	OPT-REFD1884E12	OPT-REFD1884E110	72" x 12" (M)	3/4"	260,000
96" x 18" Pan Kit	OPT-REFD1896	N/A	N/A	OPT-REFD1896E12	OPT-REFD1896E110	84" x 12" (M)	3/4"	300,000

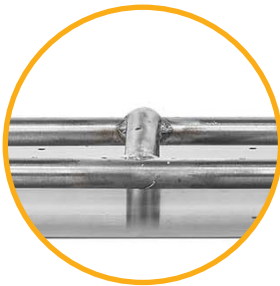

Raised Gas Hub



ELECTRONIC IGNITION ACCESSORIES

GAS ACCESSORIES



REMOTE CONTROL & WIRELESS RECEIVER
OPT-RC110V



WEATHERPROOF ON/OFF SWITCH
OPT-WPS110V



110V EMERGENCY STOP BUTTON
OPT-ESTOP



110V 1-HOUR DIAL TIMER
OPT-DTM



GAS TIMER & EMERGENCY STOP
OPT-ESTOPTM



NATURAL GAS KIT
OPT-NGKNG - 0-290K BTU
OPT-NGKNGHC - 291K+ BTU



LIQUID PROPANE KIT
OPT-LPKLP - 0-290K BTU
OPT-LPKLPHC - 291K+ BTU

FLAT PAN & STAINLESS STEEL BURNER KITS



Suitable for either natural gas or liquid propane applications. Electronic ignition systems require 10" clearance below the pan. 110V Ignition System Kits use a 3-prong grounded plug.

BURNER SIZE GUIDE: **M** = Double Inlet and uses manifold that adds 5" in height below the pan ; **2R** = 2 Rings ; **3R** = 3 Rings ; **4R** = 4 Rings

Low Voltage Ignition

Plug & Play To Low Voltage

Flame Sense



Rectangular Flat Pan & SS Switchback Burner

ITEM	PAN & BURNER ONLY	FLAME SENSE MATCH LIT CERTIFIED	FLAME SENSE W/ SPARK IGNITION	LOW VOLTAGE	PLUG & PLAY TO LOW VOLTAGE	BURNER SIZE	GAS INLET	BTU
24" x 12" Pan Kit	OPT-RFSB1224	OPT-RFSB1224FSML	OPT-RFSB1224FSEN	OPT-RFSB1224E12	OPT-RFSB1224E110	18" x 6"	½"	60,000
30" x 12" Pan Kit	OPT-RFSB1230	OPT-RFSB1230FSML	OPT-RFSB1230FSEN	OPT-RFSB1230E12	OPT-RFSB1230E110	24" x 6"	½"	75,000
36" x 12" Pan Kit	OPT-RFSB1236	OPT-RFSB1236FSML	OPT-RFSB1236FSEN	OPT-RFSB1236E12	OPT-RFSB1236E110	30" x 6"	½"	90,000
42" x 12" Pan Kit	OPT-RFSB1242	N/A	N/A	OPT-RFSB1242E12	OPT-RFSB1242E110	36" x 6"	½"	105,000
48" x 12" Pan Kit	OPT-RFSB1248	N/A	N/A	OPT-RFSB1248E12	OPT-RFSB1248E110	42" x 6"	½"	125,000
60" x 12" Pan Kit	OPT-RFSB1260	N/A	N/A	OPT-RFSB1260E12	OPT-RFSB1260E110	48" x 6"	½"	140,000
72" x 12" Pan Kit	OPT-RFSB1272	N/A	N/A	OPT-RFSB1272E12	OPT-RFSB1272E110	60" x 6" (M)	¾"	170,000
84" x 12" Pan Kit	OPT-RFSB1284	N/A	N/A	OPT-RFSB1284E12	OPT-RFSB1284E110	72" x 6" (M)	¾"	200,000
96" x 12" Pan Kit	OPT-RFSB1296	N/A	N/A	OPT-RFSB1296E12	OPT-RFSB1296E110	84" x 6" (M)	¾"	305,000
24" x 18" Pan Kit	OPT-RFSB1824	OPT-RFSB1824FSML	OPT-RFSB1824FSEN	OPT-RFSB1824E12	OPT-RFSB1824E110	18" x 12"	½"	60,000
30" x 18" Pan Kit	OPT-RFSB1830	OPT-RFSB1830FSML	OPT-RFSB1830FSEN	OPT-RFSB1830E12	OPT-RFSB1830E110	24" x 12"	½"	75,000
36" x 18" Pan Kit	OPT-RFSB1836	OPT-RFSB1836FSML	OPT-RFSB1836FSEN	OPT-RFSB1836E12	OPT-RFSB1836E110	30" x 12"	½"	90,000
42" x 18" Pan Kit	OPT-RFSB1842	OPT-RFSB1842FSML	OPT-RFSB1842FSEN	OPT-RFSB1842E12	OPT-RFSB1842E110	36" x 12"	½"	105,000
48" x 18" Pan Kit	OPT-RFSB1848	N/A	N/A	OPT-RFSB1848E12	OPT-RFSB1848E110	42" x 12"	½"	125,000
60" x 18" Pan Kit	OPT-RFSB1860	N/A	N/A	OPT-RFSB1860E12	OPT-RFSB1860E110	48" x 12"	½"	140,000
72" x 18" Pan Kit	OPT-RFSB1872	N/A	N/A	OPT-RFSB1872E12	OPT-RFSB1872E110	60" x 12" (M)	¾"	170,000
84" x 18" Pan Kit	OPT-RFSB1884	N/A	N/A	OPT-RFSB1884E12	OPT-RFSB1884E110	72" x 12" (M)	¾"	200,000
96" x 18" Pan Kit	OPT-RFSB1896	N/A	N/A	OPT-RFSB1896E12	OPT-RFSB1896E110	84" x 12" (M)	¾"	305,000



Custom Oversized Linear Pan and Burner
Courtesy of Steele's Signature Pools, LLC, Medford, NJ, Sea Girt, NJ

DROP IN PAN & STAINLESS STEEL BURNER KITS

Suitable for either natural gas or liquid propane applications. Pans have 1" Lip & 2" Height. Electronic ignition systems require 10" clearance below the pan. 110V Ignition System Kits use a 3-prong grounded plug.

BURNER SIZE GUIDE: **M** = Double Inlet and uses manifold that adds 5" in height below the pan ; **2R** = 2 Rings ; **3R** = 3 Rings ; **4R** = 4 Rings

Low Voltage Ignition



Plug & Play To Low Voltage



Flame Sense



Round Drop In Pan & Round SS Burner

ITEM	PAN & BURNER ONLY	FLAME SENSE MATCH LIT CERTIFIED	FLAME SENSE W/ SPARK IGNITION	LOW VOLTAGE	PLUG & PLAY TO LOW VOLTAGE	BURNER SIZE	GAS INLET	BTU
13" Drop In Kit	OPT-PBR13	OPT-PBR13FSML	OPT-PBR13FSEN	OPT-PBR13E12	OPT-PBR13E110	6"	1/2"	35,000
19" Drop In Kit	OPT-PBR19	OPT-PBR19FSML	OPT-PBR19FSEN	OPT-PBR19E12	OPT-PBR19E110	12"	1/2"	65,000
25" Drop In Kit	OPT-PBR25	OPT-PBR25FSML	OPT-PBR25FSEN	OPT-PBR25E12	OPT-PBR25E110	18" (2R)	1/2"	160,000
31" Drop In Kit	OPT-PBR31	N/A	OPT-PBR31FSEN	OPT-PBR31E12	OPT-PBR31E110	24" (2R)	1/2"	190,000
37" Drop In Kit	OPT-PBR37	N/A	N/A	OPT-PBR37E12	OPT-PBR37E110	30" (3R)	3/4"	330,000
43" Drop In Kit	OPT-PBR43	N/A	N/A	OPT-PBR43E12	OPT-PBR43E110	36" (3R)	3/4"	380,000



1" Flange
2" Depth



Raised Gas Hub



ELECTRONIC IGNITION ACCESSORIES

GAS ACCESSORIES



DROP IN PAN & STAINLESS STEEL BURNER KITS



Low Voltage Ignition

Plug & Play To Low Voltage

Flame Sense



Round Drop In Pan & SS Lotus Burner

ITEM	PAN & BURNER ONLY	FLAME SENSE MATCH LIT CERTIFIED	FLAME SENSE W/ SPARK IGNITION	LOW VOLTAGE	PLUG & PLAY TO LOW VOLTAGE	BURNER SIZE	GAS INLET	BTU
19" Drop In Kit	OPT-PBRLF19	OPT-PBRLF19FSML	OPT-PBRLF19FSEN	OPT-PBRLF19E12	OPT-PBRLF19E110	12"	½"	90,000
25" Drop In Kit	OPT-PBRLF25	OPT-PBRLF25FSML	OPT-PBRLF25FSEN	OPT-PBRLF25E12	OPT-PBRLF25E110	18"	½"	115,000
31" Drop In Kit	OPT-PBRLF31	N/A	OPT-PBRLF31FSEN	OPT-PBRLF31E12	OPT-PBRLF31E110	24"	½"	175,000
37" Drop In Kit	OPT-PBRLF37	N/A	N/A	OPT-PBRLF37E12	OPT-PBRLF37E110	30"	½"	220,000
43" Drop In Kit	OPT-PBRLF43	N/A	N/A	OPT-PBRLF43E12	OPT-PBRLF43E110	36"	¾"	265,000



**1" Flange
2" Depth**

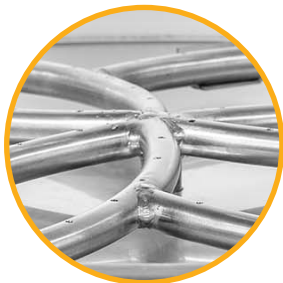

Raised Gas Hub



DROP IN PAN & STAINLESS STEEL BURNER KITS

Suitable for either natural gas or liquid propane applications. Pans have 1" Lip & 2" Height. Electronic ignition systems require 10" clearance below the pan. 110V Ignition System Kits use a 3-prong grounded plug.

BURNER SIZE GUIDE: **M** = Double Inlet and uses manifold that adds 5" in height below the pan ; **2R** = 2 Rings ; **3R** = 3 Rings ; **4R** = 4 Rings

Low Voltage Ignition

Plug & Play To Low Voltage

Flame Sense



Square Drop In Pan & Square SS Burner

ITEM	PAN & BURNER ONLY	FLAME SENSE MATCH LIT CERTIFIED	FLAME SENSE W/ SPARK IGNITION	LOW VOLTAGE	PLUG & PLAY TO LOW VOLTAGE	BURNER SIZE	GAS INLET	BTU
16.5" Drop In Kit	OPT-PBS16	OPT-PBS16FSML	OPT-PBS16FSEN	OPT-PBS16E12	OPT-PBS16E110	12"	1/2"	80,000
18" Drop In Kit	OPT-PBS18	OPT-PBS18FSML	OPT-PBS18FSEN	OPT-PBS18E12	OPT-PBS18E110	12"	1/2"	80,000
24" Drop In Kit	OPT-PBS24	OPT-PBS24FSML	OPT-PBS24FSEN	OPT-PBS24E12	OPT-PBS24E110	18" (2R)	1/2"	200,000
30" Drop In Kit	OPT-PBS30	N/A	OPT-PBS30FSEN	OPT-PBS30E12	OPT-PBS30E110	24" (2R)	1/2"	240,000
36" Drop In Kit	OPT-PBS36	N/A	N/A	OPT-PBS36E12	OPT-PBS36E110	30" (3R)	3/4"	420,000
48" Drop In Kit	OPT-PBS48	N/A	N/A	OPT-PBS48E12	OPT-PBS48E110	36" (3R)	3/4"	480,000

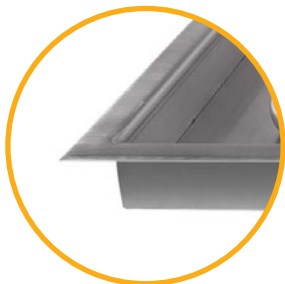

**1" Flange
2" Depth**

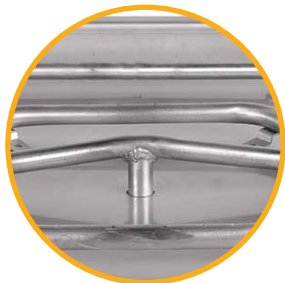

Raised Gas Hub



ELECTRONIC IGNITION ACCESSORIES

GAS ACCESSORIES



REMOTE CONTROL & WIRELESS RECEIVER
OPT-RC110V



WEATHERPROOF ON/OFF SWITCH
OPT-WPS110V



110V EMERGENCY STOP BUTTON
OPT-ESTOP



110V 1-HOUR DIAL TIMER
OPT-DTM



GAS TIMER & EMERGENCY STOP
OPT-ESTOPTM



NATURAL GAS KIT
OPT-NGKNG - 0-290K BTU
OPT-NGKNGHC - 291K+ BTU



LIQUID PROPANE KIT
OPT-LPKLP - 0-290K BTU
OPT-LPKLPHC - 291K+ BTU

Low Voltage Ignition

Plug & Play To Low Voltage

Flame Sense

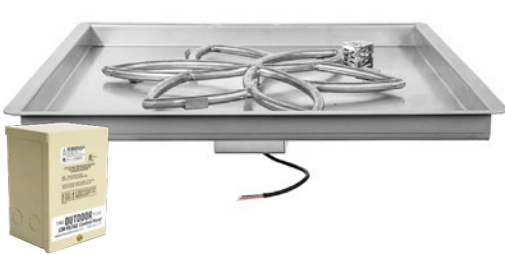

Square Drop In Pan & SS Lotus Burner

ITEM	PAN & BURNER ONLY	FLAME SENSE MATCH LIT CERTIFIED	FLAME SENSE W/ SPARK IGNITION	LOW VOLTAGE	PLUG & PLAY TO LOW VOLTAGE	BURNER SIZE	GAS INLET	BTU
16.5" Drop In Kit	OPT-PBSLF16	OPT-PBSLF16FSML	OPT-PBSLF16FSEN	OPT-PBSLF16E12	OPT-PBSLF16E110	12"	½"	90,000
18" Drop In Kit	OPT-PBSLF18	OPT-PBSLF18FSML	OPT-PBSLF18FSEN	OPT-PBSLF18E12	OPT-PBSLF18E110	12"	½"	100,000
24" Drop In Kit	OPT-PBSLF24	OPT-PBSLF24FSML	OPT-PBSLF24FSEN	OPT-PBSLF24E12	OPT-PBSLF24E110	18"	½"	160,000
30" Drop In Kit	OPT-PBSLF30	N/A	OPT-PBSLF30FSEN	OPT-PBSLF30E12	OPT-PBSLF30E110	24"	½"	190,000
36" Drop In Kit	OPT-PBSLF36	N/A	N/A	OPT-PBSLF36E12	OPT-PBSLF36E110	30"	¾"	260,000
48" Drop In Kit	OPT-PBSLF48	N/A	N/A	OPT-PBSLF48E12	OPT-PBSLF48E110	36"	¾"	350,000



**1" Flange
2" Depth**



Raised Gas Hub

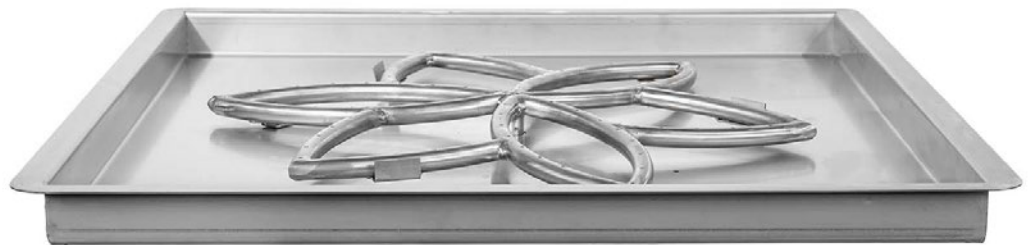

DROP IN PAN & STAINLESS STEEL BURNER KITS

Suitable for either natural gas or liquid propane applications. Pans have 1" Lip & 2" Height. Electronic ignition systems require 10" clearance below the pan. 110V Ignition System Kits use a 3-prong grounded plug.

BURNER SIZE GUIDE: **M** = Double Inlet and uses manifold that adds 5" in height below the pan ; **2R** = 2 Rings ; **3R** = 3 Rings ; **4R** = 4 Rings

Low Voltage Ignition

Plug & Play To Low Voltage

Flame Sense



Rectangular Drop In Pan & SS Linear Burner

ITEM	PAN & BURNER ONLY	FLAME SENSE MATCH LIT CERTIFIED	FLAME SENSE W/ SPARK IGNITION	LOW VOLTAGE	PLUG & PLAY TO LOW VOLTAGE	BURNER SIZE	GAS INLET	BTU
24"x6" Rectangle	OPT-RT24	OPT-RT24FSML	OPT-RT24FSEN	OPT-RT24E12	OPT-RT24E110	18"	½"	30,000
30"x6" Rectangle	OPT-RT30	OPT-RT30FSML	OPT-RT30FSEN	OPT-RT30E12	OPT-RT30E110	24"	½"	40,000
36"x6" Rectangle	OPT-RT36	OPT-RT36FSML	OPT-RT36FSEN	OPT-RT36E12	OPT-RT36E110	30"	½"	50,000
42"x6" Rectangle	OPT-RT42	OPT-RT42FSML	OPT-RT42FSEN	OPT-RT42E12	OPT-RT42E110	36"	½"	60,000
48"x6" Rectangle	OPT-RT48	OPT-RT48FSML	OPT-RT48FSEN	OPT-RT48E12	OPT-RT48E110	42"	½"	70,000
60"x6" Rectangle	OPT-RT60	OPT-RT60FSML	OPT-RT60FSEN	OPT-RT60E12	OPT-RT60E110	48"	½"	80,000
72"x6" Rectangle	OPT-RT72	OPT-RT72FSML	OPT-RT72FSEN	OPT-RT72E12	OPT-RT72E110	60"	¾"	100,000
84"x6" Rectangle	OPT-RT84	N/A	N/A	OPT-RT84E12	OPT-RT84E110	72"	¾"	120,000
96"x6" Rectangle	OPT-RT96	N/A	N/A	OPT-RT96E12	OPT-RT96E110	84"	¾"	140,000



**1" Flange
2" Depth**

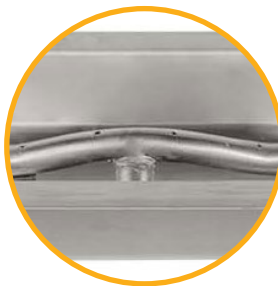

Raised Gas Hub



ELECTRONIC IGNITION ACCESSORIES

GAS ACCESSORIES



Low Voltage Ignition

Plug & Play To Low Voltage

Flame Sense



Rectangular Drop In Pan & SS 'H' Burner

ITEM	PAN & BURNER ONLY	FLAME SENSE MATCH LIT CERTIFIED	FLAME SENSE W/ SPARK IGNITION	LOW VOLTAGE	PLUG & PLAY TO LOW VOLTAGE	BURNER SIZE	GAS INLET	BTU
24"x12" Rectangle	OPT-PB1224	OPT-PB1224FSML	OPT-PB1224FSEN	OPT-PB1224E12	OPT-PB1224E110	18" x 6"	½"	70,000
30"x12" Rectangle	OPT-PB1230	OPT-PB1230FSML	OPT-PB1230FSEN	OPT-PB1230E12	OPT-PB1230E110	24" x 6"	½"	90,000
36"x12" Rectangle	OPT-PB1236	OPT-PB1236FSML	OPT-PB1236FSEN	OPT-PB1236E12	OPT-PB1236E110	30" x 6"	½"	110,000
42"x12" Rectangle	OPT-PB1242	OPT-PB1242FSML	OPT-PB1242FSEN	OPT-PB1242E12	OPT-PB1242E110	36" x 6"	½"	130,000
48"x12" Rectangle	OPT-PB1248	N/A	N/A	OPT-PB1248E12	OPT-PB1248E110	42" x 6"	½"	150,000
60"x12" Rectangle	OPT-PB1260	N/A	N/A	OPT-PB1260E12	OPT-PB1260E110	48" x 6"	½"	170,000
72"x12" Rectangle	OPT-PB1272	N/A	N/A	OPT-PB1272E12	OPT-PB1272E110	60" x 6"	¾"	210,000
84"x12" Rectangle	OPT-PB1284	N/A	N/A	OPT-PB1284E12	OPT-PB1284E110	72" x 6" (M)	¾"	250,000
96"x12" Rectangle	OPT-PB1296	N/A	N/A	OPT-PB1296E12	OPT-PB1296E110	84" x 6" (M)	¾"	290,000



**1" Flange
2" Depth**



Raised Gas Hub



DROP IN PAN & STAINLESS STEEL BURNER KITS

Suitable for either natural gas or liquid propane applications. Pans have 1" Lip & 2" Height. Electronic ignition systems require 10" clearance below the pan. 110V Ignition System Kits use a 3-prong grounded plug.

BURNER SIZE GUIDE: **M** = Double Inlet and uses manifold that adds 5" in height below the pan ; **2R** = 2 Rings ; **3R** = 3 Rings ; **4R** = 4 Rings

Low Voltage Ignition

Plug & Play To Low Voltage

Flame Sense



Rectangular Drop In Pan & SS Switchback Burner

ITEM	PAN & BURNER ONLY	FLAME SENSE MATCH LIT CERTIFIED	FLAME SENSE W/ SPARK IGNITION	LOW VOLTAGE	PLUG & PLAY TO LOW VOLTAGE	BURNER SIZE	GAS INLET	BTU
24"x12" Rectangle	OPT-PBSB1224	OPT-PBSB1224FSML	OPT-PBSB1224FSEN	OPT-PBSB1224E12	OPT-PBSB1224E110	18" x 6"	½"	60,000
30"x12" Rectangle	OPT-PBSB1230	OPT-PBSB1230FSML	OPT-PBSB1230FSEN	OPT-PBSB1230E12	OPT-PBSB1230E110	24" x 6"	½"	75,000
36"x12" Rectangle	OPT-PBSB1236	OPT-PBSB1236FSML	OPT-PBSB1236FSEN	OPT-PBSB1236E12	OPT-PBSB1236E110	30" x 6"	½"	90,000
42"x12" Rectangle	OPT-PBSB1242	OPT-PBSB1242FSML	OPT-PBSB1242FSEN	OPT-PBSB1242E12	OPT-PBSB1242E110	36" x 6"	½"	105,000
48"x12" Rectangle	OPT-PBSB1248	N/A	N/A	OPT-PBSB1248E12	OPT-PBSB1248E110	42" x 6"	½"	125,000
60"x12" Rectangle	OPT-PBSB1260	N/A	N/A	OPT-PBSB1260E12	OPT-PBSB1260E110	48" x 6"	½"	140,000
72"x12" Rectangle	OPT-PBSB1272	N/A	N/A	OPT-PBSB1272E12	OPT-PBSB1272E110	60" x 6" (M)	¾"	170,000
84"x12" Rectangle	OPT-PBSB1284	N/A	N/A	OPT-PBSB1284E12	OPT-PBSB1284E110	72" x 6" (M)	¾"	200,000
96"x12" Rectangle	OPT-PBSB1296	N/A	N/A	OPT-PBSB1296E12	OPT-PBSB1296E110	84" x 6" (M)	¾"	305,000

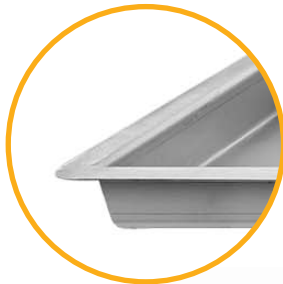

**1" Flange
2" Depth**



Raised Gas Hub



ELECTRONIC IGNITION ACCESSORIES

GAS ACCESSORIES



REMOTE CONTROL & WIRELESS RECEIVER
OPT-RC110V

WEATHERPROOF ON/OFF SWITCH
OPT-WPS110V

110V EMERGENCY STOP BUTTON
OPT-ESTOP

110V 1-HOUR DIAL TIMER
OPT-DTM



GAS TIMER & EMERGENCY STOP
OPT-ESTOPTM

NATURAL GAS KIT
OPT-NGKNG - 0-290K BTU
OPT-NGKNGHC - 291K+ BTU

LIQUID PROPANE KIT
OPT-LPKLP - 0-290K BTU
OPT-LPKLPHC - 291K+ BTU

RAISED LIP DROP IN PAN & SS BURNER KITS



Low Voltage Ignition



Plug & Play To Low Voltage



Flame Sense



Square Drop In Pan & Square SS Burner

ITEM	PAN & BURNER ONLY	FLAME SENSE MATCH LIT CERTIFIED	FLAME SENSE W/ SPARK IGNITION	LOW VOLTAGE	PLUG & PLAY TO LOW VOLTAGE	BURNER SIZE	GAS INLET	BTU
16.5" Drop In Kit	OPT-RLSQR16	OPT-RLSQR16FSML	OPT-RLSQR16FSEN	OPT-RLSQR16E12	OPT-RLSQR16E110	12"	½"	80,000
18" Drop In Kit	OPT-RLSQR18	OPT-RLSQR18FSML	OPT-RLSQR18FSEN	OPT-RLSQR18E12	OPT-RLSQR18E110	12"	½"	80,000
24" Drop In Kit	OPT-RLSQR24	OPT-RLSQR24FSML	OPT-RLSQR24FSEN	OPT-RLSQR24E12	OPT-RLSQR24E110	18" (2R)	½"	200,000
30" Drop In Kit	OPT-RLSQR30	N/A	OPT-RLSQR30FSEN	OPT-RLSQR30E12	OPT-RLSQR30E110	24" (2R)	½"	240,000
36" Drop In Kit	OPT-RLSQR36	N/A	N/A	OPT-RLSQR36E12	OPT-RLSQR36E110	30" (3R)	¾"	420,000
48" Drop In Kit	OPT-RLSQR48	N/A	N/A	OPT-RLSQR48E12	OPT-RLSQR48E110	36" (3R)	¾"	480,000

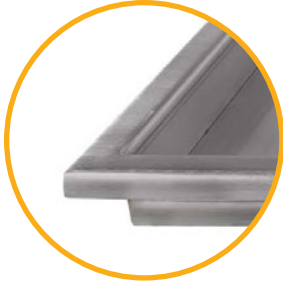

1" Flange
2" Depth



Raised Gas
Hub



RAISED LIP DROP IN PAN & STAINLESS STEEL BURNER KITS

Suitable for either natural gas or liquid propane applications. Pans have 1" x 1" Lip & 2" Height. Electronic ignition systems require 10" clearance below the pan. 110V Ignition System Kits use a 3-prong grounded plug.

BURNER SIZE GUIDE: **M** = Double Inlet and uses manifold that adds 5" in height below the pan ; **2R** = 2 Rings ; **3R** = 3 Rings ; **4R** = 4 Rings

Low Voltage Ignition

Plug & Play To Low Voltage

Flame Sense



Rectangular Drop In Pan & SS Linear Burner

ITEM	PAN & BURNER ONLY	FLAME SENSE MATCH LIT CERTIFIED	FLAME SENSE W/ SPARK IGNITION	LOW VOLTAGE	PLUG & PLAY TO LOW VOLTAGE	BURNER SIZE	GAS INLET	BTU
24"x8" Rectangle	OPT-RLRCT248	OPT-RLRCT248FSML	OPT-RLRCT248FSEN	OPT-RLRCT248E12	OPT-RLRCT248E110	18"	½"	30,000
30"x8" Rectangle	OPT-RLRCT308	OPT-RLRCT308FSML	OPT-RLRCT308FSEN	OPT-RLRCT308E12	OPT-RLRCT308E110	24"	½"	40,000
36"x8" Rectangle	OPT-RLRCT368	OPT-RLRCT368FSML	OPT-RLRCT368FSEN	OPT-RLRCT368E12	OPT-RLRCT368E110	30"	½"	50,000
42"x8" Rectangle	OPT-RLRCT428	OPT-RLRCT428FSML	OPT-RLRCT428FSEN	OPT-RLRCT428E12	OPT-RLRCT428E110	36"	½"	60,000
48"x8" Rectangle	OPT-RLRCT488	OPT-RLRCT488FSML	OPT-RLRCT488FSEN	OPT-RLRCT488E12	OPT-RLRCT488E110	42"	½"	70,000
60"x8" Rectangle	OPT-RLRCT608	OPT-RLRCT608FSML	OPT-RLRCT608FSEN	OPT-RLRCT608E12	OPT-RLRCT608E110	48"	½"	80,000
72"x8" Rectangle	OPT-RLRCT728	OPT-RLRCT728FSML	OPT-RLRCT728FSEN	OPT-RLRCT728E12	OPT-RLRCT728E110	60"	¾"	100,000
84"x8" Rectangle	OPT-RLRCT848	N/A	N/A	OPT-RLRCT848E12	OPT-RLRCT848E110	72"	¾"	120,000
96"x8" Rectangle	OPT-RLRCT968	N/A	N/A	OPT-RLRCT968E12	OPT-RLRCT968E110	84"	¾"	140,000



ELECTRONIC IGNITION ACCESSORIES

GAS ACCESSORIES



RAISED LIP DROP IN PAN & SS BURNER KITS



Low Voltage Ignition



Plug & Play To Low Voltage



Flame Sense



Rectangular Drop In Pan & SS 'H' Burner

ITEM	PAN & BURNER ONLY	FLAME SENSE MATCH LIT CERTIFIED	FLAME SENSE W/ SPARK IGNITION	LOW VOLTAGE	PLUG & PLAY TO LOW VOLTAGE	BURNER SIZE	GAS INLET	BTU
24"x12" Rectangle	OPT-RLRCT2412	OPT-RLRCT2412FSML	OPT-RLRCT2412FSEN	OPT-RLRCT2412E12	OPT-RLRCT2412E110	18" x 6"	½"	70,000
30"x12" Rectangle	OPT-RLRCT3012	OPT-RLRCT3012FSML	OPT-RLRCT3012FSEN	OPT-RLRCT3012E12	OPT-RLRCT3012E110	24" x 6"	½"	90,000
36"x12" Rectangle	OPT-RLRCT3612	OPT-RLRCT3612FSML	OPT-RLRCT3612FSEN	OPT-RLRCT3612E12	OPT-RLRCT3612E110	30" x 6"	½"	110,000
42"x12" Rectangle	OPT-RLRCT4212	OPT-RLRCT4212FSML	OPT-RLRCT4212FSEN	OPT-RLRCT4212E12	OPT-RLRCT4212E110	36" x 6"	½"	130,000
48"x12" Rectangle	OPT-RLRCT4812	N/A	N/A	OPT-RLRCT4812E12	OPT-RLRCT4812E110	42" x 6"	½"	150,000
60"x12" Rectangle	OPT-RLRCT6012	N/A	N/A	OPT-RLRCT6012E12	OPT-RLRCT6012E110	48" x 6"	½"	170,000
72"x12" Rectangle	OPT-RLRCT7212	N/A	N/A	OPT-RLRCT7212E12	OPT-RLRCT7212E110	60" x 6"	¾"	210,000
84"x12" Rectangle	OPT-RLRCT8412	N/A	N/A	OPT-RLRCT8412E12	OPT-RLRCT8412E110	72" x 6" (M)	¾"	250,000
96"x12" Rectangle	OPT-RLRCT9612	N/A	N/A	OPT-RLRCT9612E12	OPT-RLRCT9612E110	84" x 6" (M)	¾"	290,000

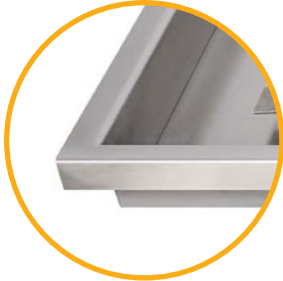

**1" Flange
2" Depth**



Raised Gas Hub



LIP-LESS DROP IN PAN & SS BURNER KITS

Suitable for either natural gas or liquid propane applications. Pans have 2" Height. Electronic ignition systems require 10" clearance below the pan. 110V Ignition System Kits use a 3-prong grounded plug.

BURNER SIZE GUIDE: **M** = Double Inlet and uses manifold that adds 5" in height below the pan ; **2R** = 2 Rings ; **3R** = 3 Rings ; **4R** = 4 Rings

Low Voltage Ignition

Plug & Play To Low Voltage

Flame Sense



Square Drop In Pan & Square SS Burner

ITEM	PAN & BURNER ONLY	FLAME SENSE MATCH LIT CERTIFIED	FLAME SENSE W/ SPARK IGNITION	LOW VOLTAGE	PLUG & PLAY TO LOW VOLTAGE	BURNER SIZE	GAS INLET	BTU
16.5" Pan Kit	OPT-LTSQR16	OPT-LTSQR16FSML	OPT-LTSQR16FSEN	OPT-LTSQR16E12	OPT-LTSQR16E110	12"	½"	80,000
18" Pan Kit	OPT-LTSQR18	OPT-LTSQR18FSML	OPT-LTSQR18FSEN	OPT-LTSQR18E12	OPT-LTSQR18E110	12"	½"	80,000
24" Pan Kit	OPT-LTSQR24	OPT-LTSQR24FSML	OPT-LTSQR24FSEN	OPT-LTSQR24E12	OPT-LTSQR24E110	18" (2R)	½"	200,000
30" Pan Kit	OPT-LTSQR30	N/A	OPT-LTSQR30FSEN	OPT-LTSQR30E12	OPT-LTSQR30E110	24" (2R)	½"	240,000
36" Pan Kit	OPT-LTSQR36	N/A	N/A	OPT-LTSQR36E12	OPT-LTSQR36E110	30" (3R)	¾"	420,000
48" Pan Kit	OPT-LTSQR48	N/A	N/A	OPT-LTSQR48E12	OPT-LTSQR48E110	36" (3R)	¾"	480,000

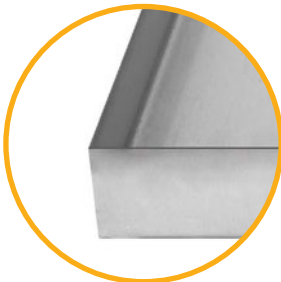

2" Depth

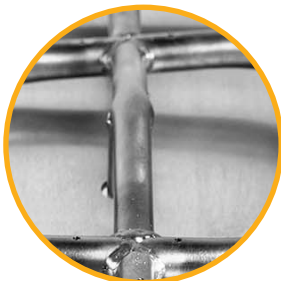

Raised Gas Hub



ELECTRONIC IGNITION ACCESSORIES

GAS ACCESSORIES



LIP-LESS DROP IN PAN & SS BURNER KITS



Low Voltage Ignition



Plug & Play To Low Voltage



Flame Sense



Round Drop In Pan & Round SS Burner

ITEM	PAN & BURNER ONLY	FLAME SENSE MATCH LIT CERTIFIED	FLAME SENSE W/ SPARK IGNITION	LOW VOLTAGE	PLUG & PLAY TO LOW VOLTAGE	BURNER SIZE	GAS INLET	BTU
12" Pan Kit	OPT-LTROR12	OPT-LTROR12FSML	OPT-LTROR12FSEN	OPT-LTROR12E12	OPT-LTROR12E110	6"	1/2"	35,000
18" Pan Kit	OPT-LTROR18	OPT-LTROR18FSML	OPT-LTROR18FSEN	OPT-LTROR18E12	OPT-LTROR18E110	12"	1/2"	65,000
24" Pan Kit	OPT-LTROR24	OPT-LTROR24FSML	OPT-LTROR24FSEN	OPT-LTROR24E12	OPT-LTROR24E110	18" (2R)	1/2"	160,000
30" Pan Kit	OPT-LTROR30	N/A	OPT-LTROR30FSEN	OPT-LTROR30E12	OPT-LTROR30E110	24" (2R)	1/2"	190,000
36" Pan Kit	OPT-LTROR36	N/A	N/A	OPT-LTROR36E12	OPT-LTROR36E110	30" (3R)	3/4"	330,000
48" Pan Kit	OPT-LTROR48	N/A	N/A	OPT-LTROR48E12	OPT-LTROR48E110	36" (3R)	3/4"	380,000



2" Depth



Raised Gas Hub



MORE FLAME, LESS GAS[®]

Proudly Made In The USA 45

LIP-LESS DROP IN PAN & SS BURNER KITS

Suitable for either natural gas or liquid propane applications. Pans have 1" x 1" Lip & 2" Height. Electronic ignition systems require 10" clearance below the pan. 110V Ignition System Kits use a 3-prong grounded plug.

BURNER SIZE GUIDE: **M** = Double Inlet and uses manifold that adds 5" in height below the pan ; **2R** = 2 Rings ; **3R** = 3 Rings ; **4R** = 4 Rings

Low Voltage Ignition

Plug & Play To Low Voltage

Flame Sense



Rectangular Drop In Pan & SS Linear Burner

ITEM	PAN & BURNER ONLY	FLAME SENSE MATCH LIT CERTIFIED	FLAME SENSE W/ SPARK IGNITION	LOW VOLTAGE	PLUG & PLAY TO LOW VOLTAGE	BURNER SIZE	GAS INLET	BTU
24"x6" Pan Kit	OPT-LTRCT246	OPT-LTRCT246FSML	OPT-LTRCT246FSEN	OPT-LTRCT246E12	OPT-LTRCT246E110	18"	1/2"	30,000
30"x6" Pan Kit	OPT-LTRCT306	OPT-LTRCT306FSML	OPT-LTRCT306FSEN	OPT-LTRCT306E12	OPT-LTRCT306E110	24"	1/2"	40,000
36"x6" Pan Kit	OPT-LTRCT366	OPT-LTRCT366FSML	OPT-LTRCT366FSEN	OPT-LTRCT366E12	OPT-LTRCT366E110	30"	1/2"	50,000
42"x6" Pan Kit	OPT-LTRCT426	OPT-LTRCT426FSML	OPT-LTRCT426FSEN	OPT-LTRCT426E12	OPT-LTRCT426E110	36"	1/2"	60,000
48"x6" Pan Kit	OPT-LTRCT486	OPT-LTRCT486FSML	OPT-LTRCT486FSEN	OPT-LTRCT486E12	OPT-LTRCT486E110	42"	1/2"	70,000
60"x6" Pan Kit	OPT-LTRCT606	OPT-LTRCT606FSML	OPT-LTRCT606FSEN	OPT-LTRCT606E12	OPT-LTRCT606E110	48"	1/2"	80,000
72"x6" Pan Kit	OPT-LTRCT726	OPT-LTRCT726FSML	OPT-LTRCT726FSEN	OPT-LTRCT726E12	OPT-LTRCT726E110	60"	3/4"	100,000
84"x6" Pan Kit	OPT-LTRCT846	N/A	N/A	OPT-LTRCT846E12	OPT-LTRCT846E110	72"	3/4"	120,000
96"x6" Pan Kit	OPT-LTRCT966	N/A	N/A	OPT-LTRCT966E12	OPT-LTRCT966E110	84"	3/4"	140,000



**1" Flange
2" Depth**

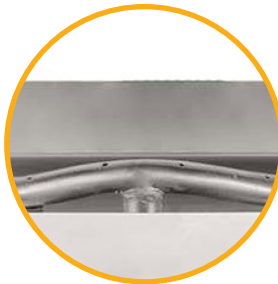

Raised Gas Hub



ELECTRONIC IGNITION ACCESSORIES

GAS ACCESSORIES

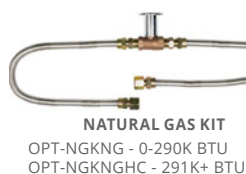

LIP-LESS DROP IN PAN & SS BURNER KITS



Low Voltage Ignition

Plug & Play To Low Voltage

Flame Sense

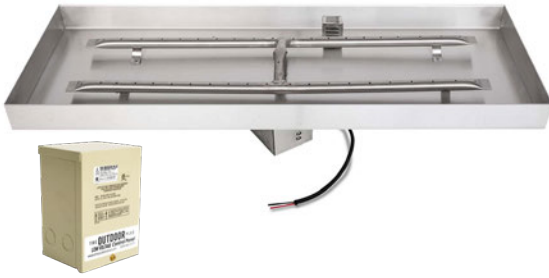

Rectangular Drop In Pan & SS 'H' Burner

ITEM	PAN & BURNER ONLY	FLAME SENSE MATCH LIT CERTIFIED	FLAME SENSE W/ SPARK IGNITION	LOW VOLTAGE	PLUG & PLAY TO LOW VOLTAGE	BURNER SIZE	GAS INLET	BTU
24"x12" Pan Kit	OPT-LTRCT2412	OPT-LTRCT2412FSML	OPT-LTRCT2412FSEN	OPT-LTRCT2412E12	OPT-LTRCT2412E110	18" x 6"	½"	70,000
30"x12" Pan Kit	OPT-LTRCT3012	OPT-LTRCT3012FSML	OPT-LTRCT3012FSEN	OPT-LTRCT3012E12	OPT-LTRCT3012E110	24" x 6"	½"	90,000
36"x12" Pan Kit	OPT-LTRCT3612	OPT-LTRCT3612FSML	OPT-LTRCT3612FSEN	OPT-LTRCT3612E12	OPT-LTRCT3612E110	30" x 6"	½"	110,000
42"x12" Pan Kit	OPT-LTRCT4212	OPT-LTRCT4212FSML	OPT-LTRCT4212FSEN	OPT-LTRCT4212E12	OPT-LTRCT4212E110	36" x 6"	½"	130,000
48"x12" Pan Kit	OPT-LTRCT4812	N/A	N/A	OPT-LTRCT4812E12	OPT-LTRCT4812E110	42" x 6"	½"	150,000
60"x12" Pan Kit	OPT-LTRCT6012	N/A	N/A	OPT-LTRCT6012E12	OPT-LTRCT6012E110	48" x 6"	½"	170,000
72"x12" Pan Kit	OPT-LTRCT7212	N/A	N/A	OPT-LTRCT7212E12	OPT-LTRCT7212E110	60" x 6"	¾"	210,000
84"x12" Pan Kit	OPT-LTRCT8412	N/A	N/A	OPT-LTRCT8412E12	OPT-LTRCT8412E110	72" x 6" (M)	¾"	250,000
96"x12" Pan Kit	OPT-LTRCT9612	N/A	N/A	OPT-LTRCT9612E12	OPT-LTRCT9612E110	84" x 6" (M)	¾"	290,000



2" Depth



Raised Gas Hub



BULLET BURNERS®

PATENTED DESIGN

The Patented Bullet Burner's eliminate the need for an additional LP air mixer. Suitable for either natural gas or liquid propane applications. Pans have 1" Lip & 2" Height. Electronic ignition require 10" clearance below the pan. 110V Ignition System Kits use a 3-prong grounded plug.

BURNER SIZE GUIDE: **M** = Double Inlet and uses manifold that adds 5" in height below the pan ; **2R** = 2 Rings ; **3R** = 3 Rings ; **4R** = 4 Rings



Triple 'S' Burner - Brass & Stainless Steel

PART # (BRASS)	PART # (STAINLESS)	DIAMETER	BTU	INLET
OPT-B8B	OPT-B8SS	8"	50000	½"
OPT-B12B	OPT-B12SS	12"	75000	½"
OPT-B18B	OPT-B18SS	18"	110000	½"
OPT-B24B	OPT-B24SS	24"	145000	½"
OPT-B30B	OPT-B30SS	30"	180000	¾"
OPT-B36B	OPT-B36SS	36"	220000	¾"
OPT-B48B	OPT-B48SS	48"	385000	¾"



Linear Brass Bullet Burner®

PART # (BRASS)	PART # (STAINLESS)	LENGTH	BTU	INLET
OPT-B12BT	OPT-B12SST	12"	25000	½"
OPT-B18BT	OPT-B18SST	18"	40000	½"
OPT-B24BT	OPT-B24SST	24"	50000	½"
OPT-B30BT	OPT-B30SST	30"	60000	½"
OPT-B36BT	OPT-B36SST	36"	75000	½"
OPT-B42BT	OPT-B42SST	42"	85000	½"
OPT-B48BT	OPT-B48SST	48"	100000	½"
OPT-B54BT	OPT-B54SST	54"	110000	½"
OPT-B60BT	OPT-B60SST	60"	120000	¾"
OPT-B66BT	OPT-B66SST	66"	135000	¾"
OPT-B72BT	OPT-B72SST	72"	145000	¾"
OPT-B84BT	OPT-B84SST	84"	170000	¾"
OPT-B90BT	OPT-B90SST	90" (M)	180000	¾"
OPT-B96BT	OPT-B96SST	96" (M)	290000	¾"



'H' Brass Bullet Burner®

PART # (BRASS)	PART # (STAINLESS)	LENGTH	WIDTH	BTU	INLET
OPT-B18BH	OPT-B18SSH	18"	6"	85000	½"
OPT-B24BH	OPT-B24SSH	24"	6"	110000	½"
OPT-B30BH	OPT-B30SSH	30"	6"	135000	½"
OPT-B36BH	OPT-B36SSH	36"	6"	160000	½"
OPT-B42BH	OPT-B42SSH	42"	6"	180000	½"
OPT-B48BH	OPT-B48SSH	48"	6"	205000	½"
OPT-B60BH	OPT-B60SSH	60" (M)	6"	255000	¾"
OPT-B72BH	OPT-B72SSH	72" (M)	6"	300000	¾"

STAINLESS STEEL BULLET BURNERS®

PATENTED DESIGN

BURNER SIZE GUIDE: **M** = Double Inlet and uses manifold that adds 5" in height below the pan ; **2R** = 2 Rings ; **3R** = 3 Rings ; **4R** = 4 Rings

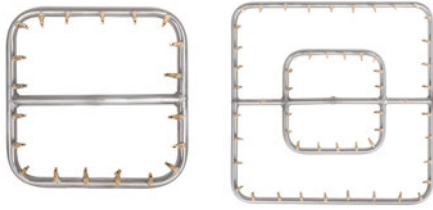

Square Stainless Bullet Burner®

PART #	SIZE	BTU	INLET
OPT-BSQSS8	8"	55,000	½"
OPT-BSQSS12	12"	80,000	½"
OPT-BSQSS18	18" (2R)	20,000	½"
OPT-BSQSS24	24" (2R)	240,000	½"
OPT-BSQSS30	30" (3R)	420,000	¾"
OPT-BSQSS36	36" (3R)	480,000	¾"
OPT-BSQSS48	48" (4R, M)	80,000	¾"



Round Stainless Bullet Burner®

PART #	SIZE	BTU	INLET
OPT-BRDSS8	8"	45,000	½"
OPT-BRDSS12	12"	65,000	½"
OPT-BRDSS18	18" (2R)	160,000	½"
OPT-BRDSS24	24" (2R)	190,000	½"
OPT-BRDSS30	30" (3R)	330,000	¾"
OPT-BRDSS36	36" (3R)	380,000	¾"
OPT-BRDSS48	48" (4R, M)	630,000	¾"



Switchback Stainless Bullet Burner®

PART #	SIZE	BTU	INLET
OPT-BSWSS18	18" x 6"	60,000	½"
OPT-BSWSS24	24" x 6"	75,000	½"
OPT-BSWSS30	30" x 6"	90,000	½"
OPT-BSWSS36	36" x 6"	105,000	½"
OPT-BSWSS48	48" x 6"	140,000	½"
OPT-BSWSS60	60" x 6" (M)	170,000	¾"
OPT-BSWSS72	72" x 6" (M)	200,000	¾"

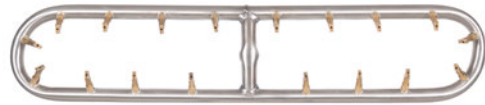

Racetrack Stainless Bullet Burner®

PART #	SIZE	BTU	INLET
OPT-BRTSS186	18" x 6"	70,000	½"
OPT-BRTSS246	24" x 6"	90,000	½"
OPT-BRTSS306	30" x 6"	110,000	½"
OPT-BRTSS366	36" x 6"	130,000	½"
OPT-BRTSS486	48" x 6"	170,000	½"
OPT-BRTSS606	60" x 6" (M)	210,000	¾"
OPT-BRTSS726	72" x 6" (M)	250,000	¾"

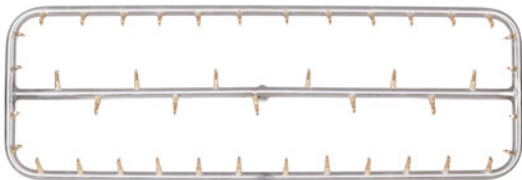

Rectangle Stainless Bullet Burner®

PART #	SIZE	BTU	INLET
OPT-BRTSS1812	18" x 12"	130,000	½"
OPT-BRTSS2412	24" x 12"	160,000	½"
OPT-BRTSS3012	30" x 12"	190,000	½"
OPT-BRTSS3612	36" x 12"	220,000	¾"
OPT-BRTSS4812	48" x 12" (M)	280,000	¾"
OPT-BRTSS6012	60" x 12" (M)	340,000	¾"
OPT-BRTSS7212	72" x 12" (M)	400,000	¾"



Double Rectangle Stainless Bullet Burner®

PART #	SIZE	BTU	INLET
OPT-BDRTSS1812	18" x 12"	190,000	½"
OPT-BDRTSS2412	24" x 12"	240,000	½"
OPT-BDRTSS3012	30" x 12"	290,000	½"
OPT-BDRTSS3612	36" x 12"	340,000	¾"
OPT-BDRTSS4812	48" x 12"	440,000	¾"
OPT-BDRTSS6012	60" x 12" (M)	540,000	¾"
OPT-BDRTSS7212	72" x 12" (M)	640,000	¾"

MORE FLAME, LESS GAS®

Proudly Made In The USA

STAINLESS STEEL BURNERS

Our fire burners are individually crafted from 304 stainless steel. T.O.P's burner holes are individually drilled, not punched, creating a better flame. Gas Inlets are slightly raised to prevent water from entering your gas line. NG or LP compatible. Made in the USA.

BURNER SIZE GUIDE: **M** = Double Inlet and uses manifold that adds 5" in height below the pan ; **2R** = 2 Rings ; **3R** = 3 Rings ; **4R** = 4 Rings



Round Burner

PART #	SIZE	INLET	BTUS
OPT-158-5	5"	1/2"	30,000
OPT-158	6"	1/2"	35,000
OPT-158-8	8"	1/2"	45,000
OPT-159-10	10"	1/2"	55,000
OPT-159	12"	1/2"	65,000
OPT-160	18" (2R)	1/2"	160,000
OPT-161	24" (2R)	1/2"	190,000
OPT-161-30	30" (3R)	3/4"	330,000
OPT-162	36" (3R)	3/4"	380,000
OPT-162-48	48" (4R) (M)	3/4"	630,000



Triple "S" Star Burner

PART #	SIZE	INLET	BTUS
OPT-3512	12"	1/2"	60,000
OPT-3518	18"	1/2"	90,000
OPT-3524	24"	1/2"	120,000
OPT-3530	30"	3/4"	150,000
OPT-3536	36"	3/4"	180,000
OPT-3542	42"	3/4"	210,000
OPT-3548	48"	3/4"	240,000



"H" Burner

PART #	SIZE	INLET	BTUS
OPT-181	6" x 18"	1/2"	70,000
OPT-182	6" x 24"	1/2"	90,000
OPT-183	6" x 30"	1/2"	110,000
OPT-184	6" x 36"	1/2"	130,000
OPT-18442	6" x 42"	1/2"	150,000
OPT-18448	6" x 48"	3/4"	170,000
OPT-18466	6" x 60" (M)	3/4"	210,000
OPT-18472	6" x 72" (M)	3/4"	250,000
OPT-18484	6" x 84" (M)	3/4"	290,000
OPT-18496	6" x 96" (M)	3/4"	410,000



"T" Burner

PART #	SIZE	INLET	BTUS
OPT-16616	16"	1/2"	30,000
OPT-167	24"	1/2"	40,000
OPT-168	30"	1/2"	50,000
OPT-169	36"	1/2"	60,000
OPT-166T42	42"	1/2"	70,000
OPT-166T48	48"	1/2"	80,000
OPT-166T54	54"	1/2"	90,000
OPT-166T60	60"	3/4"	100,000
OPT-166T66	66"	3/4"	110,000
OPT-166T72	72"	3/4"	120,000
OPT-166T84	84"	3/4"	140,000
OPT-166T90	90" (M)	3/4"	150,000
OPT-166T96	96" (M)	3/4"	160,000
OPT-166T108	108" (M)	3/4"	180,000
OPT-166T120	120" (M)	3/4"	200,000



S-Burner

PART #	SIZE	INLET	BTUS
OPT-3013	6" x 18"	1/2"	50,000
OPT-3014	6" x 24"	1/2"	50,000
OPT-301530	6" x 30"	1/2"	75,000
OPT-3015	6" x 36"	1/2"	90,000
OPT-3016	6" x 48"	1/2"	100,000
OPT-301660	6" x 60"	3/4"	120,000
OPT-3017	6" x 72"	3/4"	150,000
OPT-301784	6" x 84"	3/4"	150,000
OPT-301796	6" x 96" (M)	3/4"	200,000
OPT-3017108	6" x 108" (M)	3/4"	200,000
OPT-3017120	6" x 120" (M)	3/4"	200,000

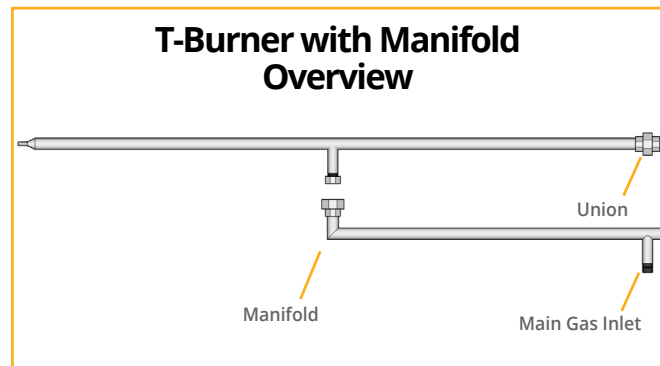

STAINLESS STEEL BURNERS



Half Moon Burner

PART #	SIZE	INLET	BTUS
OPT-HM18	18" x 9" (2R)	1/2"	80,000
OPT-HM24	24" x 12" (2R)	1/2"	90,000
OPT-HM30	30" x 15" (3R)	1/2"	120,000
OPT-HM36	36" x 18" (3R)	3/4"	140,000
OPT-HM42	42" x 21" (4R)	3/4"	150,000
OPT-HM48	48" x 24" (4R)	3/4"	175,000



Square Burner

PART #	SIZE	INLET	RINGS	BTUS
OPT-30076	6" x 6"	1/2"	1 Ring	40,000
OPT-3007	12" x 12" (2R)	1/2"	2 Rings	80,000
OPT-3008	18" x 18" (2R)	1/2"	2 Rings	200,000
OPT-3009	24" x 24" (2R)	1/2"	2 Rings	240,000
OPT-300930	30" x 30" (3R)	3/4"	3 Rings	420,000
OPT-300936	36" x 36" (3R)	3/4"	3 Rings	480,000
OPT-300942	42" x 42" (3R)	3/4"	3 Rings	520,000
OPT-300948	48" x 48" (4R) (M)	3/4"	4 Rings	800,000
OPT-300960	60" x 60" (4R) (M)	3/4"	4 Rings	880,000

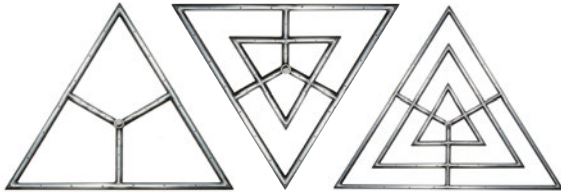

Triangle Burner

PART #	SIZE	INLET	BTUS
OPT-3001	12"	1/2"	60,000
OPT-3002	18" (2R)	1/2"	150,000
OPT-3003	24" (2R)	1/2"	180,000
OPT-300330	30" (3R)	3/4"	315,000
OPT-3004	36" (3R)	3/4"	360,000
OPT-300448	48" (4R)	3/4"	600,000



Rectangle Burner

PART #	SIZE	INLET	BTUS
OPT-3010	6" x 12"	1/2"	60,000
OPT-3011	6" x 18"	1/2"	80,000
OPT-301124	6" x 24"	1/2"	100,000
OPT-301130	6" x 30"	1/2"	120,000
OPT-301136	6" x 36"	1/2"	140,000
OPT-301148	6" x 48"	3/4"	180,000
OPT-3012	12" x 24"	1/2"	120,000
OPT-301230	12" x 30"	1/2"	140,000
OPT-301236	12" x 36"	3/4"	160,000
OPT-301242	12" x 42"	3/4"	180,000
OPT-301248	12" x 48"	3/4"	200,000
OPT-301260	12" x 60" (M)	3/4"	240,000
OPT-301272	12" x 72" (M)	3/4"	280,000

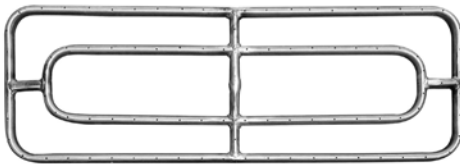

Double Rectangle Burner

PART #	SIZE	INLET	BTUS
OPT-DR1224	12" x 24"	1/2"	200,000
OPT-DR1230	12" x 30"	1/2"	240,000
OPT-DR1236	12" x 36"	1/2"	280,000
OPT-DR1242	12" x 42"	1/2"	320,000
OPT-DR1248	12" x 48"	3/4"	360,000
OPT-DR1260	12" x 60"	3/4"	440,000
OPT-DR1272	12" x 72"	3/4"	520,000
OPT-DR1830	18" x 30"	3/4"	280,000
OPT-DR1836	18" x 36"	3/4"	320,000
OPT-DR1842	18" x 42"	3/4"	360,000
OPT-DR1848	18" x 48"	3/4"	400,000
OPT-DR1860	18" x 60" (M)	3/4"	480,000



Lotus Burner

PART #	SIZE	INLET	BTUS
OPT-18LTS	18"	1/2"	125,000
OPT-24LTS	24"	1/2"	150,000
OPT-30LTS	30"	1/2"	200,000
OPT-36LTS	36"	3/4"	220,000
OPT-42LTS	42"	3/4"	260,000
OPT-48LTS	48"	3/4"	300,000

MORE FLAME, LESS GAS®

Proudly Made In The USA

STAINLESS STEEL BURNERS

Our fire burners are individually crafted from 304 stainless steel. T.O.P's burner holes are individually drilled, not punched, creating a better flame. Gas Inlets are slightly raised to prevent water from entering your gas line. NG or LP compatible. Made in the USA.

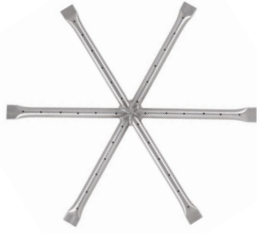

Star Burner

PART #	SIZE	INLET	BTU
OPT-171	12"	1/2"	90,000
OPT-171A	16"	1/2"	90,000
OPT-17118	18"	1/2"	90,000
OPT-172	24"	1/2"	150,000
OPT-17230	30"	3/4"	200,000
OPT-17236	36"	3/4"	300,000
OPT-17248	48"	3/4"	300,000

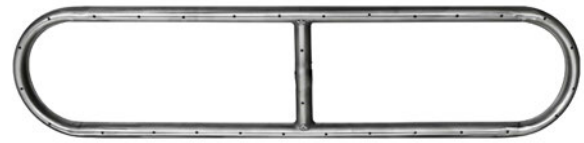

Racetrack Steel Burner

PART #	SIZE	INLET	BTUS
OPT-RT618	6" x 18"	1/2"	50,000
OPT-RT624	6" x 24"	1/2"	60,000
OPT-RT630	6" x 30"	1/2"	70,000
OPT-RT636	6" x 36"	1/2"	90,000
OPT-RT648	6" x 48"	1/2"	100,000
OPT-RT1224	12" x 24"	1/2"	80,000
OPT-RT1230	12" x 30"	1/2"	90,000
OPT-RT1236	12" x 36"	1/2"	90,000
OPT-RT1242	12" x 42"	1/2"	100,000
OPT-RT1248	12" x 48"	1/2"	180,000
OPT-RT1254	12" x 54"	3/4"	190,000
OPT-RT1260	12" x 60" (M)	3/4"	200,000
OPT-RT1272	12" x 72" (M)	3/4"	240,000



Double Racetrack Burner

PART #	SIZE	INLET	BTUS
OPT-DRT1224	12" x 24"	1/2"	90,000
OPT-DRT1230	12" x 30"	1/2"	90,000
OPT-DRT1236	12" x 36"	1/2"	100,000
OPT-DRT1242	12" x 42"	1/2"	120,000
OPT-DRT1248	12" x 48"	3/4"	140,000
OPT-DRT1254	12" x 54"	3/4"	200,000
OPT-DRT1260	12" x 60" (M)	3/4"	220,000
OPT-DRT1272	12" x 72" (M)	3/4"	220,000
OPT-DRT1830	18" x 30"	3/4"	100,000
OPT-DRT1836	18" x 36"	3/4"	120,000
OPT-DRT1842	18" x 42"	3/4"	120,000
OPT-DRT1848	18" x 48"	3/4"	180,000
OPT-DRT1860	18" x 60" (M)	3/4"	190,000
OPT-DRT1872	18" x 72" (M)	3/4"	200,000
OPT-DRT1884	18" x 84" (M)	3/4"	200,000



Switch Back Burner

PART #	SIZE	INLET	BTUS
OPT-SB18	7" x 18"	1/2"	65,000
OPT-SB24	7" x 24"	1/2"	75,000
OPT-SB30	7" x 30"	1/2"	90,000
OPT-SB36	7" x 36"	1/2"	100,000
OPT-SB48	7" x 48"	1/2"	120,000
OPT-SB60	7" x 60" (M)	3/4"	160,000
OPT-SB72	7" x 72" (M)	3/4"	200,000
OPT-SB84	7" x 84" (M)	3/4"	240,000
OPT-SB96	7" x 96" (M)	3/4"	280,000
OPT-SB108	7" x 108" (M)	3/4"	320,000
OPT-SB120	7" x 120" (M)	3/4"	400,000
OPT-SB2412	12" x 24" (M)	1/2"	65,000
OPT-SB3012	12" x 30"	1/2"	75,000
OPT-SB3612	12" x 36"	1/2"	90,000
OPT-SB4812	12" x 48"	1/2"	100,000
OPT-SB6012	12" x 60" (M)	3/4"	120,000
OPT-SB7212	12" x 72" (M)	3/4"	160,000
OPT-SB8412	12" x 84" (M)	3/4"	200,000
OPT-SB9612	12" x 96" (M)	3/4"	240,000
OPT-SB10812	12" x 108" (M)	3/4"	280,000
OPT-SB12012	12" x 120" (M)	3/4"	400,000

STAINLESS STEEL BURNERS

BURNER SIZE GUIDE: **M** = Double Inlet and uses manifold that adds 5" in height below the pan ; **2R** = 2 Rings ; **3R** = 3 Rings ; **4R** = 4 Rings



Fish Eye Burner

PART #	SIZE	INLET	BTUS
OPT-FE18	6" x 18"	1/2"	70,000
OPT-FE24	6" x 24"	1/2"	70,000
OPT-FE30	6" x 30"	1/2"	90,000
OPT-FE36	6" x 36"	1/2"	150,000
OPT-FE48	6" x 48"	1/2"	150,000

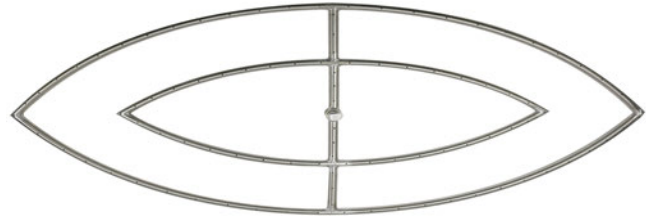

Double Fish Eye Burner

PART #	SIZE	INLET	BTUS
OPT-FE24D	12" x 24"	1/2"	100,000
OPT-FE36D	12" x 36"	1/2"	140,000
OPT-FE48D	12" x 48"	3/4"	180,000
OPT-FE60D	12" x 60"	3/4"	200,000



Wheel Burner

PART #	SIZE	INLET	BTUS
OPT-W18	18"	1/2"	125,000
OPT-W24	24"	1/2"	150,000
OPT-W30	30"	1/2"	200,000
OPT-W36	36"	3/4"	220,000
OPT-W42	42"	3/4"	260,000
OPT-W48	48"	3/4"	300,000



Single Ring Burner

PART #	SIZE	INLET	BTUS
OPT-12SR	12"	1/2"	60,000
OPT-18SR	18"	1/2"	70,000
OPT-24SR	24"	1/2"	80,000
OPT-30SR	30"	1/2"	90,000
OPT-36SR	36"	3/4"	90,000
OPT-42SR	42"	3/4"	100,000
OPT-48SR	48"	3/4"	100,000

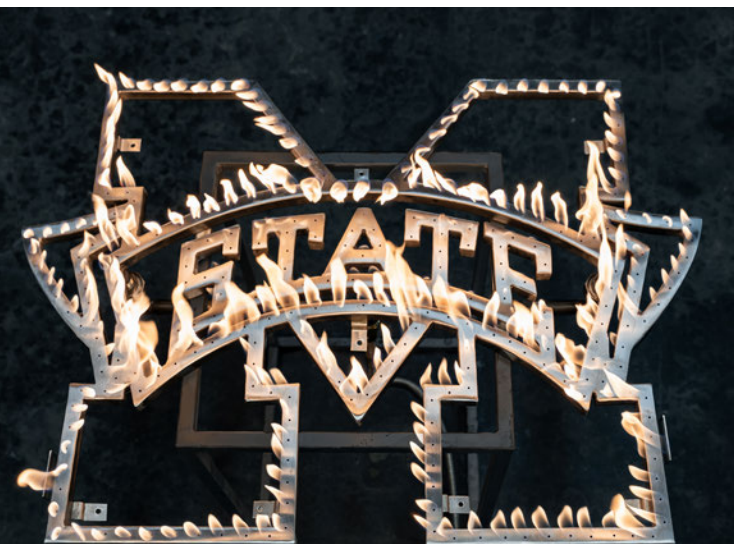

Custom Burners Any Size, Any Shape

Do you need a specific size? Do you have an logo or design that you would like created in burner form? We can do that for you!

We manufacture all of T.O.P.'s products in house and that allows us to build practically anything. Design it yourself or send in pencil sketches and T.O.P.'s in house specialist can design it for you. Email or call us today to learn more!

FIREPLACE BURNERS



FIREPLACE LOG LIGHTER BURNER

PART #	SIZE	INLET	BTUS
OPT-173-12	12"	1/2"	20,000
OPT-173	18"	1/2"	30,000
OPT-174	24"	1/2"	40,000
OPT-175	30"	1/2"	50,000
OPT-17536	36"	1/2"	60,000
OPT-17542	42"	1/2"	70,000
OPT-17548	48"	1/2"	80,000
OPT-17560	60"	3/4"	100,000

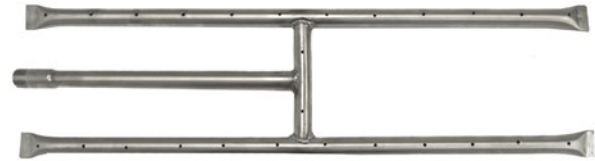

FIREPLACE H-BURNER

PART #	SIZE	INLET	BTUS
OPT-154	6" x 18"	1/2"	70,000
OPT-155	6" x 24"	1/2"	90,000
OPT-156	6" x 30"	1/2"	110,000
OPT-157	6" x 36"	1/2"	130,000
OPT-15748	12" x 48"	3/4"	170,000
OPT-15760	12" x 60"	3/4"	210,000
OPT-15772	12" x 72"	3/4"	250,000

Stainless Steel Whistle Free Hose

Includes: Hose, Flare to Non-Flared Fittings. Max 1/2 PSI



LENGTH	3/8" HOSE (1/2" FITTINGS)	1/2" HOSE (1/2" FITTINGS)	3/4" HOSE (3/4" FITTINGS)
12"	OPT-245	OPT-238	N/A
18"	OPT-246	OPT-239	N/A
24"	OPT-247	OPT-240	N/A
36"	OPT-248	OPT-241	OPT-248HC
48"	OPT-249	OPT-242	N/A



Gas Key Valves

Includes Key Valve, Valve Cover & Key

ITEM	CHROME	GOLD	ANTIQUE	BLACK
1/2" Standard Key Valve	OPT-256	OPT-256GO	OPT-256AN	OPT-256BL
1/2" Ball Valve	OPT-256FF	OPT-256FFGO	OPT-256FFAN	OPT-256FFBL
3/4" Ball Valve	OPT-25634	OPT-25634GGO	OPT-25634 AN	OPT-25634BL
1/2" Ball Valve 90° Bend	OPT-259FF	OPT-259FFGO	OPT-259FFAN	OPT-259FFBL
3/4" Ball Valve 90° Bend	OPT-35690	OPT-35690GO	OPT-35690AN	OPT-35690BL

Looking to add some flare to your fireplace? See T.O.P's ornaments & sculpture collection on the next page

Custom Stainless Steel Sculpture



Custom 48" Stainless Steel Tangled Fireplace Burner

FIREPLACE SCREENS

Our fireplace screens are more than just utilitarian. Make a statement with one of T.O.P.'s specially designed screens

Rigid steel frame, laser cut designs back with mesh.
Full steel construction & powder coated finish.

The screen stands on two legs pointed forward
Each screen can be made to fit any custom size if needed.

MODEL	PART #	WIDTH	HEIGHT	WEIGHT
Deer Country	OPT-FPS4030DC	40"	30"	24 lbs.
Twin Lions	OPT-FPS4030TL	40"	30"	24 lbs.
Wetlands	OPT-FPS4030WL	40"	30"	24 lbs.
Gone Fishing	OPT-FPS4030GF	40"	30"	24 lbs.
Big Bear	OPT-FPS4030BB	40"	30"	24 lbs.



Deer Country



Twin Lions



Wetlands



Gone Fishing



Big Bear

SMART WEATHER ELECTRONIC IGNITION SYSTEM (SWEIS)

The Smart Weather Electronic Ignition System (SWEIS) is an automated ignition system for any fire pit and fire bowl. We offer 3 different output options to make sure you have the right unit for your fire feature, regardless of the size. The SWEIS is offered in either Low Voltage or 110V Plug & Play options to accommodate different kind of installations. . Each unit comes with a 1 Year Limited Warranty

Works with LP or NG

TOP's Smart Weather Electronic Ignition System is compatible with both Natural Gas and Liquid Propane (Portable LP Tank or Hard Line LP are both okay!)

Safety is T.O.P.'s Goal

The SWEIS is tested to withstand winds up to 55mph. If the flame is blown out, the unit will automatically reignite. The unit will shut off automatically in unsafe, severe rain & wind conditions.

Weather Tested

Proven to operate properly in mild wind, rain & snow.

Compact Construction

The small construction allows it to be installed in tight spaces.

1 Year Limited Warranty

Covers all components of the Electronic Ignition System

14 Volts or 110 Volts

Different types of electricity for different kinds of applications.

Low Voltage is required for installations near pools, spas & other bodies of water

110V Plug & Play System

The three prong plug speeds up installation and only requires an weather protected GFCI socket with a light switch

Functions with:

On/Off Switches, Remote Control, Pool Remote, Smart Home System, Electric Timers and Emergency Stop Buttons

Low Voltage Smart Weather Electronic Ignition System

When you order any of T.O.P.'s Low Voltage SWEIS kits, you will receive an Electronic Valve, a Pilot Igniter, and a 12V-14V Transformer.

Our pilots use an hot surface igniter (HSI) for pilot ignition and a thermocouple flame sensor to ensure the feature is lit properly and stops gas flow if the flame is ever blown out. The electronic valve is rated for temperatures between -20°F - 175°F (-28°C - 80°C). The valve enclosure includes an LED diagnostic light to indicate proper operation and to help ease trouble shooting.



Low Voltage Mini Capacity System

TOP-500EIS-100-12

- » Maximum Gas Output: 190K BTU/hr
- » Inlet Gas Pressure Limit: ½ PSI
- » Inlet / Outlet Size: ½" FIP
- » Electrical Rating: 14VAC
- » L: 4.75" W: 4" H: 4"



Low Voltage Standard Capacity System

TOP-500EIS-200-12

- » Maximum Gas Output: 290K BTU/hr
- » Inlet Gas Pressure Limit: ½ PSI
- » Inlet / Outlet Size: ½" FIP
- » Electrical Rating: 14VAC
- » L: 5.5" W: 4" H: 4"



Low Voltage High Capacity System

TOP-500EIS-300-12

- » Maximum Gas Output: 510K BTU/hr
- » Inlet Gas Pressure Limit: ½ PSI
- » Inlet / Outlet Size: ¾" FIP
- » Electrical Rating: 14VACI
- » L: 6" W: 5" H: 5"

110V Plug & Play Smart Weather Electronic Ignition System

When you order any of T.O.P.'s 110V SWEIS kits, you will receive an Electronic Valve with a 3-Prong Plug and a Pilot Igniter

Our pilots use an hot surface igniter (HSI) for pilot ignition and a thermocouple flame sensor to ensure the feature is lit properly and stops gas flow if the flame is ever blown out. The electronic valve is rated for temperatures between -20°F - 175°F (-28°C - 80°C). The valve enclosure includes an LED diagnostic light to indicate proper operation and to help ease trouble shooting.



110V Mini Capacity System

TOP-500EIS-100-110

- » Max Gas Output: 190K BTU/hr
- » Max Inlet Gas Pressure: ½ PSI
- » Inlet / Outlet Size: ½" FIP
- » Electrical Rating: 110VAC
- » L: 5.5" W: 7" H: 3"



110V Standard Capacity System

TOP-500EIS-200-110

- » Max Gas Output: 290K BTU/hr
- » Max Inlet Gas Pressure: ½ PSI
- » Inlet / Outlet Size: ½" FIP
- » Electrical Rating: 110VAC
- » L: 5.75" W: 7" H: 3.75"



110V High Capacity System

TOP-500EIS-300-110

- » Max Gas Output: 510K BTU/hr
- » Max Inlet Gas Pressure: ½ PSI
- » Inlet / Outlet Size: ¾" FIP
- » Electrical Rating: 110VAC
- » L: 6" W: 7.25" H: 3.75"



Emergency Stop Button

OPT-ESTOP

- » Outdoor Rated Electrical Box And Cover
- » 3x Conduit Entries (½")
- » Suited For 110V Only
- » **Not Compatible With Match Lit Systems**



1-Hour Button Timer

OPT-BTTS

- » Outdoor Rated Electrical Box And Cover
- » 3x Conduit Entries (½")
- » Suited For 110V Only
- » Modes: 10 min., 20 min., 30 min., 60 min., Hold
- » **Not Compatible With Match Lit Systems**



Emergency Stop Button with Key

OPT-ESTOPKEY

- » Outdoor Rated
- » 2X Conduit Entries (½")
- » Includes Two Keys
- » Suited For 110V Only
- » **Not Compatible With Match Lit Systems**



Remote Control & Wireless Receiver

OPT-RC110V

- » Outdoor Rated Box
- » Suited for 110V ONLY
- » Includes Remote & Wireless Receiver
- » **Not Compatible With Match Lit Systems**



Wireless Remote Replacement

OPT-XRM

Electrical Dial Timer

OPT-DTM

- » 1-Hour Timer
- » Outdoor Rated Electrical Box And Cover
- » Suited For 110V Only
- » **Not Compatible With Match Lit Systems**



Weatherproof On/Off Switch

OPT-WPS110V

- » On/Off only
- » Outdoor Rated Electrical Box And Cover
- » Suited For 110V Only
- » **Not Compatible With Match Lit Systems**



Bluetooth Electronic Adapter

TOP-500BLU

- » Provides you with Bluetooth control for all electronic ignition systems
- » Suitable for 14VAC Only
- » Supports iOS and Android
- » Free Smart Phone app available



Electrical Junction Box

OPT-JBOX

- » Unifying electrical outdoor rated protection box
- » Can suitably protect electrical features around water elements
- » Features grounding port for protection against electrical surges

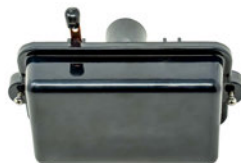

Outdoor Portable Electronic Remote

OPT-ODPER

- » 3-Prong Plug
- » Outdoor rated electronic remote
- » Suitable for 120VAC Only
- » Convenient for remote operation of fire features
- » For use into GFCI Outlet

SWEIS Replacement Components



Pilot Igniter

TOP-500PI

- » Length: 19"
- » Stainless Steel / Brass Construction
- » Hot Surface Igniter (HSI)
- » Thermocouple Flame Sensor
- » Heat/Weather Resistant Sleeve



Low Voltage Control Panel

TOP-12VCP

- » 300 Watt
- » Input Voltage: 110/120 VAC
- » Output Voltage: 12/13/14VAC
- » Suitable for Swimming Pools, Spas & Fountains
- » Removable Mounting Brackets
- » Total of 10 Knock Out Locations



Pilot Igniter Extensions

TOP-PIEXT

- » Length: 60"
- » Gas Line Extension
- » Hot Surface Igniter Extension
- » Thermocouple Extension
- » Only for the 14V/110V SWEIS Pilot Igniter



Glow Plug Replacement

TOP-PIGP

- » Only for the Low Voltage/110V SWEIS Pilot Igniter



Pilot Igniter Cover

TOP-PIC

- » 304 Stainless Steel
- » Only for the 14V/110V SWEIS Pilot Igniter



Thermocouple Replacement

TOP-PITC

- » Only for the Low Voltage/110V SWEIS Pilot Igniter

Spark Ignition Kits



LP Spark Igniter Kit

OPT-2322LP

Includes: Mounting plate, Push Button Igniter, Push Button Electrical Leads, Brass Key Valve, Turn Key, 3/8" SS Whistle Free Hose - 30", LP Regulator, Spark Igniter Cover, LP Air Mix

LP Spark Igniter Kit - High Capacity

OPT-2322LPHC - Applications over 300K BTUs

Includes: Mounting plate, Push Button Igniter, Push Button Electrical Leads, Brass Key Valve, Turn Key, 1/2" SS Whistle Free Hose - 30", LP Regulator, Spark Igniter Cover, LP Air Mix



NG Spark Igniter Kit

OPT-2322NG

Includes: Mounting Plate, Push Button Igniter, Push Button Electrical Leads, Brass Key Valve, Turn Key, 3/8" 1/2" SS Whistle Free Hoses (2x), Spark Igniter Cover, NG Orifice

NG Spark Igniter Kit - High Capacity

OPT-2322NGHC - Applications over 300K BTUs

Includes: Mounting Plate, Push Button Igniter, Push Button Electrical Leads, Brass Key Valve, Turn Key, 3/8" 1/2" SS Whistle Free Hoses (2x), Spark Igniter Cover, NG Orifice

SPARK IGNITION KITS



Spark Igniter Kit - Push Button & 36\"/>

OPT-SIPB



Push Button Only

OPT-RPB



Electrode - 36\"/>

OPT-P36



Electrode Cover

OPT-PIC

Spark Igniter Diagram

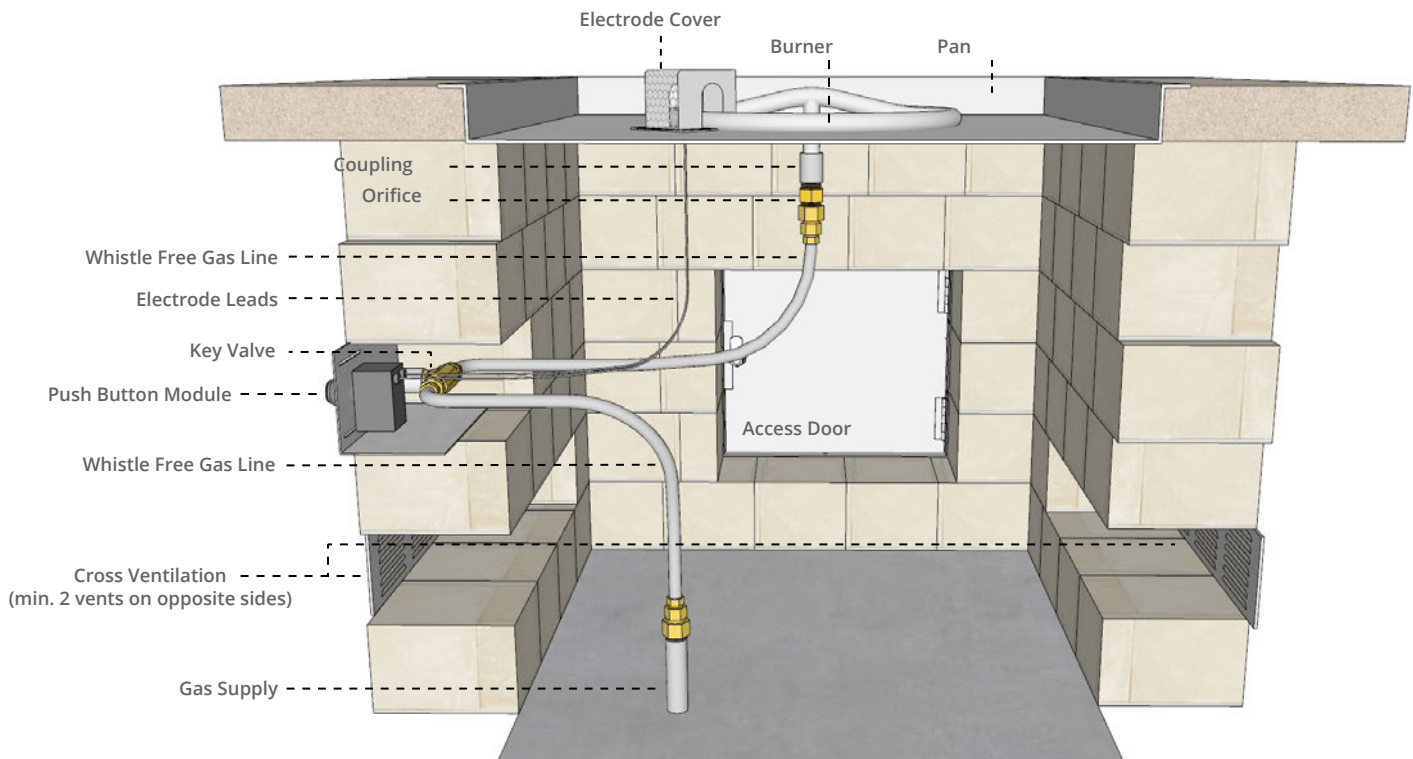

MORE FLAME, LESS GAS 

FLAME SENSE VALVE KITS



Flame Sense Valve

TOP-FSML

- » Includes: Flame Sense Valve, Heat Sensor
- » W: 7-5/8" H: 3" D: 7"
- » 30" Leads
- » Must be installed in a cavity that is at least 10" deep to accommodate the gas lines that will be connected
- » CSA Certified



Flame Sense Valve - L

TOP-FSML-LP

- » Includes: Flame Sense Valve, Heat Sensor, (1x) 6ft LP Regulator, (1x) SS Whistle Free Hose, LP Air Mixing Orifice
- » W: 7-5/8" H: 3" D: 7"
- » 30" Leads
- » Must be installed in cavity that is at least 10" deep to accommodate gas connections
- » CSA Certified



Flame Sense Valve - N

TOP-FSML-NG

- » Includes: Flame Sense Valve, Heat Sensor, (2x) SS Whistle Free Hose, NG Orifice
- » W: 7-5/8" H: 3" D: 7"
- » 30" Leads
- » Must be installed in a cavity that is at least 10" deep to accommodate gas connections
- » CSA Certified



Flame Sense with Spark Igniter

TOP-FSPBI

- » Includes: Flame Sense Valve, Push Button Spark Igniter
- » W: 7-5/8" H: 3" D: 7"
- » 30" Leads
- » Must be installed in a cavity that is at least 10" deep to accommodate the gas lines that will be connected



Flame Sense with Spark Igniter (Liquid Propane)

TOP-FSPBI-LP

- » Includes: Flame Sense Valve with Push Button Spark Igniter, (1x) SS Whistle Free Hose, (1x) 6ft LP Regulator, LP Air Mixing Orifice
- » W: 7-5/8" H: 3" D: 8"
- » 30" Leads
- » Must be installed in a cavity that is at least 10" deep to accommodate the gas lines that will be connected



Flame Sense with Spark Igniter (Natural Gas)

TOP-FSPBI-NG

- » Includes: Flame Sense Valve with Push Button Spark Igniter, (2x) SS Whistle Free Hose, NG Orifice
- » W: 7-5/8" H: 3" D: 8"
- » 30" Leads
- » Must be installed in a cavity that is at least 10" deep to accommodate the gas lines that will be connected

Flame Sense Replacement Components



Flame Sense Valve

OPT-FSGV



Flame Sense Pilot

OPT-FSPL-LP
OPT-FSPL-NG



On/Off Knob Cover

OPT-FSOC



Pilot Hood

OPT-FSPG



Thermocouple

OPT-FSTC



NG Orifice 39

OPT-FSNGO



Propane Orifice 23

OPT-FSLPO

GAS KITS, HOSES AND ACCESSORIES



Adjustable Paver Bracket

Height: 3.875" ; Width: Min - 8" ; Max - 14" ; Depth: 4"

Natural Gas Paver Bracket & Gas Kit

OPT-PB256NG

Includes: Adjustable SS Bracket, Key Valve, Turn Key, 24" Whistle Free Hoses (2x), NG Orifice

Natural Gas Paver Bracket & Gas Kit - Hi-Cap

OPT-PB256NGHC

Includes: Adjustable SS Bracket, Full Flow Key Valve, Turn Key, 24" Whistle Free Hoses (2x), NG Orifice

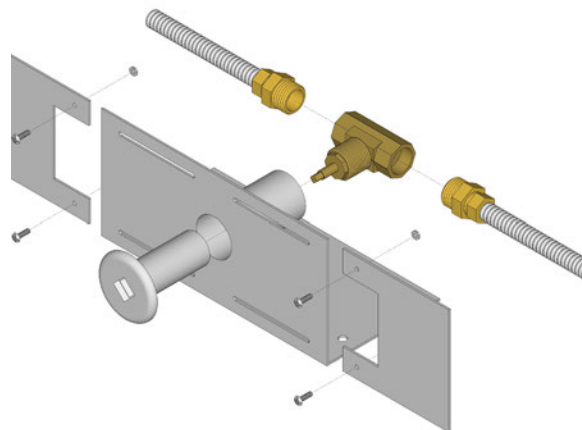

Liquid Propane Paver Bracket & Gas Kit

OPT-PB256LP

Includes: Adjustable SS Bracket, Key Valve, Turn Key, 24" Whistle Free Hose, LP Regulator, LP Air Mix Orifice

Liquid Propane Paver Bracket & Gas Kit - Hi-Cap

OPT-PB256LPHC

Includes: Adjustable SS Bracket, Full Flow Key Valve, Turn Key, 24" Whistle Free Hose, LP Regulator, LP Air Mix Orifice

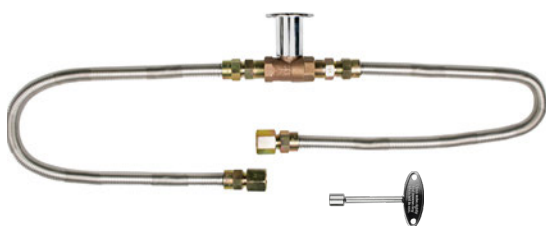

Gas Kits

Natural Gas Kit - Up to 290K BTUs

OPT-NGKNG

Includes: Key Valve, Turn Key, 24" Whistle Free Hoses (2x), Natural Gas Orifice

Natural Gas Kit - High Capacity - 300k+ BTUs

OPT-NGKNGHC

Includes: Full Flow Key Valve, Turn Key, 24" Whistle Free Hoses (2x), Natural Gas Orifice

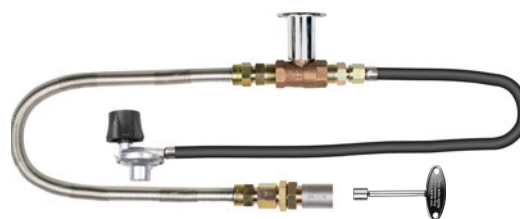

Liquid Propane Gas Kit - Up to 290K BTUs

OPT-LPKLP

Includes: Key Valve, Turn Key, 24" Whistle Free Hose, LP Regulator, LP Air Mix Orifice

Liquid Propane Gas Kit - High Capacity - 300k+ BTUs

OPT-LPKLPHC

Includes: Key Valve, Turn Key, 24" Whistle Free Hose, LP Regulator, LP Air Mix Orifice

Gas Conversion Kits



Natural Gas to Liquid Propane Conversion Kit

OPT-LPCKIT

Includes: LP Air Mixing Orifice, Coupling, Propane Regulator with Hose



Liquid Propane to Natural Gas Conversion Kit

OPT-NGCKIT

Includes: Natural Gas Orifice, Coupling, 1/2" Whistle Free Hose

MORE FLAME, LESS GAS[®]

Proudly Made In The USA

GAS KITS, HOSES AND ACCESSORIES



	Chrome	Gold	Antique	Black
1/2" Standard Key Valve	OPT-256	OPT-256GO	OPT-256AN	OPT-256BL
1/2" Ball Valve	OPT-256FF	OPT-256FFGO	OPT-256FFAN	OPT-256FFBL
3/4" Ball Valve	OPT-25634	OPT-25634GGO	OPT-25634 AN	OPT-25634BL
1/2" Ball Valve 90° Bend	OPT-259FF	OPT-259FFGO	OPT-259FFAN	OPT-259FFBL
3/4" Ball Valve 90° Bend	OPT-35690	OPT-35690GO	OPT-35690AN	OPT-35690BL



Stainless Steel Whistle Free Hose

Includes: Hose, Flare to Non-Flared Fittings. Max 1/2 PSI

Length	3/8" Hose (1/2" Fittings)	1/2" Hose (1/2" Fittings)	3/4" Hose (3/4" Fittings)
12"	OPT-245	OPT-238	N/A
18"	OPT-246	OPT-239	N/A
24"	OPT-247	OPT-240	N/A
36"	OPT-248	OPT-241	OPT-248HC
48"	OPT-249	OPT-242	N/A



LP Regulator - 48"

OPT-1300
 » 36" Hose
 » 3/8" Flared Fitting



LP Regulator - 96"

OPT-130096
 » 96" Hose
 » 5/8" Flared Fitting



High Pressure LP Hose - 6'

OPT-1321HP
 » 72" Hose
 » 3/8" Flared Fitting



Quick Connect Gas Hose

3/8" Hose

OPT-QCHOSE
 » For Propane
 » Length: 8 ft.
 » 3/8" Flared
 » 1/2" NPT

1/2" Hose

OPT-QCHOSEHC
 » For Natural Gas
 » Length: 8 ft.
 » 1/2" Flared
 » 3/4" NPT



Turn Key for Gas Key Valves

4" Key	OPT-RKV
8" Key	OPT-RKV8
11" Key	OPT-RKV11
16" Key	OPT-RKV16
22" Key	OPT-RKV22



Gas Timer & E-Stop

OPT-ESTOPTM
 » 1-Hour Max
 » Outdoor Rated
 » 4x Gas Entries (1/2" NPT)
 » 2 Entries Provided for Alternative Connection Options
 » **W:** 2-7/8" **H:** 4" **D:** 2-1/2"



Gas Timer & E-Stop With Recessed Panel

OPT-ESTOPTMPL
 » 1-Hour Max
 » Outdoor Rated
 » 4X Gas Entries (1/2")
 » 2 Entries provided for alternative connection options
 » Includes 2x 90° Elbows



Gas Ball Valve

OPT-NGBV
 » 1/2" NPT
 » Ball Valve



Natural Gas Regulator

OPT-1300NGR
 » 1/2" Inlet
 » Max 1/2 PSI

Gas Fittings



	Description	Part #
1	3/8" Flared Male x 1/2" Male	OPT-23B
1	1/2" Flared Male x 1/2" Male	OPT-232
1	3/4" Flared Male x 3/4" Male	OPT-23234
2	3/8" Flared Male x 1/2 Female	OPT-23CC
2	1/2" Flared Male x 1/2 Female	OPT-231
2	3/4" Flared Male x 3/4 Female	OPT-23134
3	1/2" Liquid Propane Air Mix	OPT-232A
4	3/4" Liquid Propane Air Mix	OPT-232AHC
5	1/2" Natural Gas Orifice	OPT-NG012

	Description	Part #
5	3/4" Natural Gas Orifice	OPT-NG012HC
6	90° 3/8" Male x 1/2" Female	OPT-903812
7	1/2" Coupling	OPT-SSNC
7	3/4" Coupling	OPT-SSNC34
8	1/2" 90° Elbow	OPT-SSN90
8	3/4" 90° Elbow	OPT-SSN9034
9	1/2" T' Joint	OPT-SSNT
9	3/4" T' Joint	OPT-SSNT34
10	1/2" Union	OPT-SSUN

	Description	Part #
10	3/4" Union	OPT-SSUN34
11	1/2" Street Elbow 90°	OPT-SSSEB
12	3/4" To 1/2" Bell Fitting	OPT-SS2TO3
13	1/2" Closed Nipple	OPT-SSN
13	1/2" 3" Long Nipple	OPT-SSN3
13	1/2" 6" Long Nipple	OPT-SSN6
13	3/4" Closed Nipple	OPT-SSN34
13	3/4" 3" Long Nipple	OPT-SSN334
13	3/4" 6" Long Nipple	OPT-SSN634



110V Electronic Ignition System Add-On

Add "-EKIT" To The End Of The Fire Pit SKU

- » **Includes:** SWEIS Electronic Valve with 3-prong Power Cord, Pilot Igniter
- » Electronic Ignition Kit Installed Onto Any Fire Pit Of Your Choice
- » Add-on ONLY
- » Includes the cost of the components and installation.
- » 110V Option for plug & play applications
- » Not suitable for installation within 5ft of water.
- » Pan shown as example only - Will use pan that is included with the fire pit



Low Voltage Electronic Ignition System Add-On

Add "-E12V" To The End Of The Fire Pit SKU

- » **Includes:** SWEIS Electronic Valve, Pilot Igniter, 12v-14v Transformer
- » Electronic Ignition Kit Installed Onto Any Fire Pit Of Your Choice
- » Add-on ONLY
- » Includes the cost of the components and installation.
- » Must be installed by a certified professional.
- » Pan shown as example only - Will use pan that is included with the fire pit



Flame Sense with Spark Igniter Add-On

Add "-FSEN" To The End Of The Fire Pit SKU

- » **Includes:** Stainless Steel Panel, Key Valve, Key, Push Button Igniter, Electrode
- » Stainless Steel panel installed onto the side of any fire pit of your choice.
- » No Assembly Required
- » Add-on ONLY, cannot be bought separately.
- » Requires 1 AA Battery

Can be stacked with the Gas Timer w/ Emergency Stop "-GTESP"



Flame Sense with Match Lit Add-On

Add "-FSML" To The End Of The Fire Pit SKU

- » **Includes:** Flame Sense System, Manual Gas Valve, Flame Sensor,
- » Stainless Steel panel installed onto the side of any fire pit of your choice.
- » No Assembly Required
- » Add-on ONLY, cannot be bought separately.
- » No Batteries or Electricity Required

Can be stacked with the Gas Timer w/ Emergency Stop "-GTESP"



Dial Timer Panel Add-On

Add "-DTMP" To The End Of The Fire Pit SKU

- » NOT Compatible With Match Lit Units
- » Includes: Dial Timer (110V), Key Valve, Key, Panel
- » Stainless Steel panel installed onto any fire pit of your choice.
- » No Assembly Required
- » Add-on ONLY, cannot be bought separately.
- » Fire Pit MUST Have Electronic Ignition



Gas Timer w/ Emergency Stop Panel Add-On

Add "-GTESP" To The End Of The Fire Pit SKU

- » Includes: Stainless Steel Panel, Key Valve, Key, Gas Timer w/ Emergency Stop
- » Stainless Steel panel installed onto the side of any fire pit of your choice.
- » No Assembly Required
- » Add-on ONLY, cannot be bought separately.
- » Battery Powered



Spark Igniter Panel Add-On

Add "-PBSIP" To The End Of The Fire Pit SKU

- » Includes: Stainless Steel Panel, Key Valve, Key, Push Button Igniter, Electrode,
- » Stainless Steel panel installed onto the side of any fire pit of your choice.
- » No Assembly Required
- » Add-on ONLY, cannot be bought separately.
- » Battery Powered



1 Hr Timer With Key Valve - Recessed Panel

OPT-BTTSKVRP

- » Adjustable Flame
- » ADA Compliant
- » 1-Hour Max
- » Outdoor Rated
- » Durable Stainless Steel Construction
- » L: 6-1/2" W: 5-1/2"
- » Flange: 3/4"
- » 1" Depth on All Panels

Can be stacked with the Gas Timer w/ Emergency Stop "-GTESP"

Note: For curved surfaces panel dimensions will vary

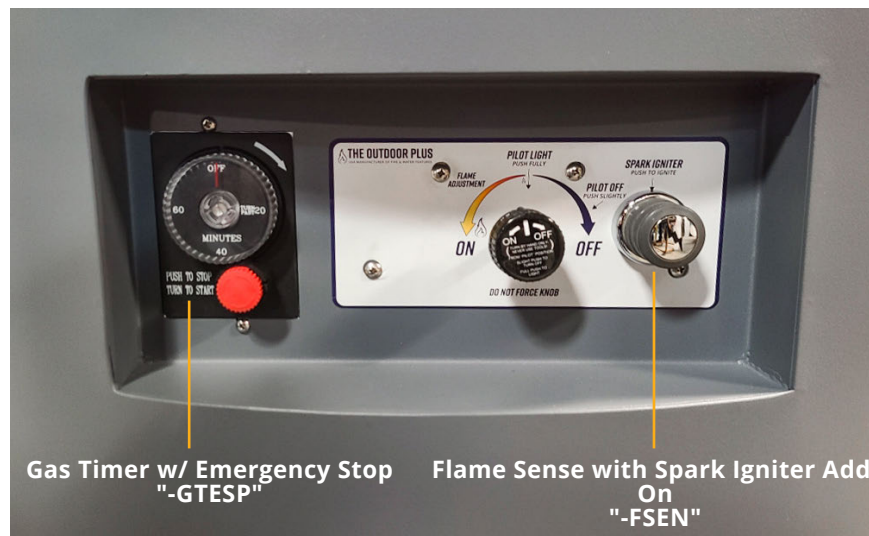

Gas Timer w/ Emergency Stop "-GTESP"

Flame Sense with Spark Igniter Add-On "-FSEN"

UPGRADE PANEL ADD-ONS



Bluetooth Electronic Adapter With Key Valve - Recessed Panel

OPT-BTTSKVRP

- » Bluetooth provides control for all electronic ignition systems
- » Suitable for 14VAC Only
- » Supports iOS and Android
- » Outdoor Rated
- » Durable Stainless Steel Construction
- » **L:** 11" **W:** 4-3/4"
- » **Flange:** 3/4"
- » 1" Depth on All Panels

Note: For curved surfaces panel dimensions will vary



Gas Timer With E-Stop & Key Valve - Recessed Panel

-GTESPKVRP

- » 1-Hour Max Timer
- » Outdoor Rated
- » 4x Gas Entries (1/2" NPT)
- » Outdoor Rated
- » 2 Entries provided for alternative connection options
- » Includes 2x 90° Elbows
- » Durable Stainless Steel Construction
- » **L:** 7-12" **W:** 6-1/2"
- » **Flange:** 3/4"
- » 1" Depth on All Panels

Note: For curved surfaces panel dimensions will vary



Gas Timer With E-Stop, Push Button & Key Valve - Recessed Panel

OPT-GTESTOPTMPBKVRP

- » 1-Hour Max Timer
- » Outdoor Rated
- » 4x Gas Entries (1/2" NPT)
- » Outdoor Rated
- » 2 Entries provided for alternative connection options
- » Includes 2x 90° Elbows
- » Durable Stainless Steel Construction
- » **L:** 7-12" **W:** 6-1/2"
- » **Flange:** 3/4"
- » 1" Depth on All Panels

Note: For curved surfaces panel dimensions will vary



Light Switch With Key Valve - Recessed Panel

OPT-RC110VKVRP

- » Suitable for 110V Only
- » Includes Remote & Wireless Receiver
- » Outdoor Rated
- » Durable Stainless Steel Construction
- » **L:** 6-1/2" **W:** 5-1/2"
- » **Flange:** 3/4"
- » 1" Depth on All Panels

Note: For curved surfaces panel dimensions will vary



Gas Timer With E-Stop - Trapezoid Panel

OPT-ESTOPTMTP

- » 1-Hour Max Timer
- » Outdoor Rated
- » 4x Gas Entries (1/2" NPT)
- » Outdoor Rated
- » 2 Entries provided for alternative connection options
- » Includes 2x 90° Elbows
- » Durable Stainless Steel Construction
- » **TL:** 5-1/2" **BL:** 8-1/4" **W:** 5"
- » **Flange:** 3/4"
- » 1" Depth on All Panels

Note: For curved surfaces panel dimensions will vary



Weatherproof Switch With Key Valve - Recessed Panel

OPT-WPS110VKVRP

- » On/Off Only
- » Suited For 110V Only
- » Outdoor Rated
- » Durable Stainless Steel Construction
- » **L:** 6" **W:** 5"
- » **Flange:** 1/4"
- » 1" Depth on All Panels

Note: For curved surfaces panel dimensions will vary

INTRODUCING THE FLAME SENSE FOR BOWLS & FIRE PITS

The Flame Sense valve is the solution for a certified match lit unit with added safety features and CSA certification. It does not require any batteries or electrical connections so installation is easier and simpler than ever. This unit is compatible with majority of T.O.P's fire features.



◆ Thermopile Technology

The thermopile sensors in this unit is the defining factor of safety. By using a thermopile sensor this unit will not release gas without a flame being present.

◆ Automatic Flame Shut Off

By using the same thermopile technology, the unit is able to sense if a flame has gone out and automatically turn itself off. This is great in case a sudden gust of wind or rainfall extinguishes your flames.

◆ Electricity Free

The unit does not use batteries or electrical current to operate. This makes it safe to install near bodies of water, eliminates the need to run electrical lines and eases up installation.

◆ Easy Installation

The valve uses two simple gas in & gas out inlets. Simply connect two gas hoses with flared fittings to get this unit running.

◆ Weather Tested

Proven to operate properly in mild wind, rain & snow.

◆ Compact Construction

The small construction allows it to be installed in tight spaces.

◆ 1 Year Limited Warranty

Covers all components of the Electronic Ignition System

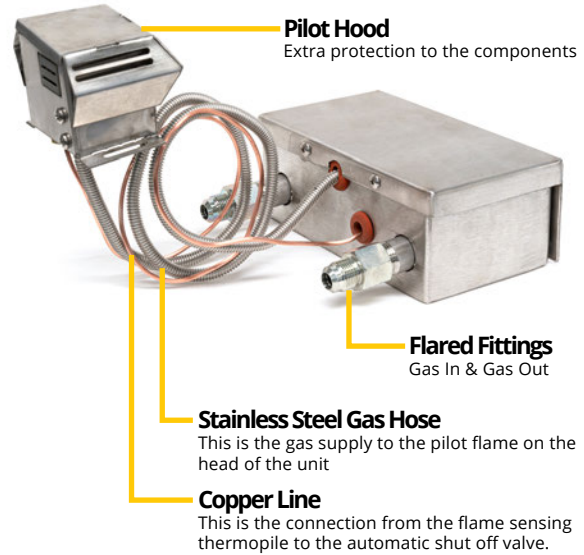

BUILD YOUR OWN FIRE PIT

If you are building a fire pit from scratch using paver blocks, use these components to eliminate the hassle of figuring out which components you'll need. All you need to know is the desired fire pit opening and find a flat pan kit to fit.

'Build Your Own' Fire Pit Checklist

- 1 Choose any desired Pan & Burner Kit
- 2 Find perimeter of Fire Pit Area and get the required Z-Brackets for any flat pan application
- 3 Get the Paver Bracket with Key Valve and Gas Line. Choose either LP or NG (Paver brackets are width adjustable from 8" - 14")
- 4 Don't forget your ventilation (Prevents dangerous gas buildup inside the enclosure)
- 5 Finally, your access doors to hide away a propane tank or to make future maintenance a breeze! Optional but highly recommended

Completed Fire Pit

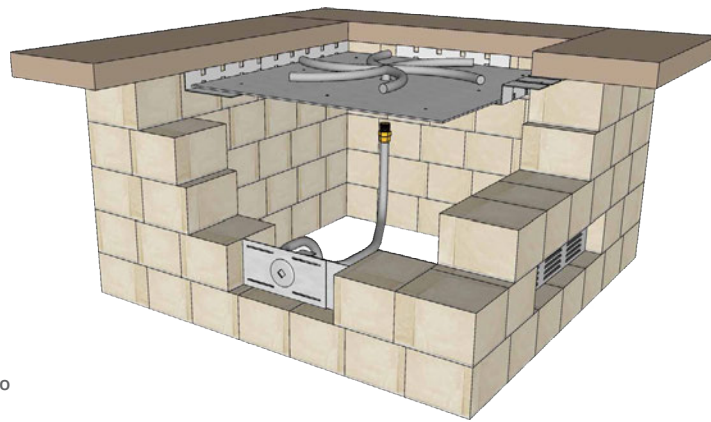

Gas Kit with Paver Bracket

The Paver Bracket makes it easy to install a key valve onto any DIY paver/brick fire pit. Simply install it in place of a paver. Adhere using a couple of anchors or adhesive.
Height: 3.875" ; **Width:** Min - 8", Max - 14" ; **Depth:** 4"

NG Gas Kit with Paver Bracket

OPT-PB256NG - Natural Gas
 OPT-PB256NGHC - Natural Gas over 300K BTU
 » Includes: Adjustable SS Bracket, Key Valve, Turn Key, 24" 1/2" Whistle Free Hoses (2x), NG Orifice

LP Gas Kit with Paver Bracket

OPT-PB256LP - Liquid Propane
 OPT-PB256LPHC - Liquid Propane over 300K BTU
 » Includes: Adjustable SS Bracket, Key Valve, Turn Key, 24" 3/8" Whistle Free Hose, LP Regulator, LP Air Mix Orifice



Rectangular Vents

- » Aluminum Vent for all fire pits
- » Flush Surface Mount

5" x 4" Vent OPT-VENT54
16" x 4" Vent OPT-VENT164

Custom sizes available



Access Door

- » Doors come equipped with a lock latch.
- » Includes holes for added ventilation
- » 304 Stainless Steel
- » Brushed Finish.

14" x 17" Door OPT-ADSS1417
8" x 8" Door OPT-ADSS88
10" x 10" Door OPT-ADSS1010
12" x 12" Door OPT-ADSS1212

Custom sizes available



Round Vents

- » Aluminum Vent for all fire pits
- » Inserts into 2", 3", or 4" hole
- » Depth: 3/4"

2" Vent OPT-RVENT2
3" Vent OPT-RVENT3
4" Vent OPT-RVENT4

Custom sizes available

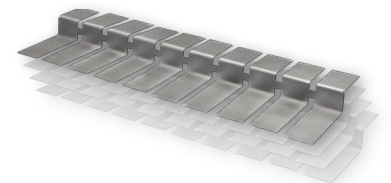

24" Z-Mounting Brackets

OPT-ZBRKT

- » Z-Brackets are designed to ease the installation of flat pan kits in DIY Fire Pits
- » Brackets are flexible to suit both rectangle & round fire pit's burn areas
- » Made of 304 Stainless Steel
- » **Length:** 24" ; **Height:** 2" ; **Depth:** 5"



Custom Stainless Steel Vents

We can make vents for your fire feature in any shape and any size, and even with a custom design. Call or email us today to inquire about custom vents.

MORE FLAME, LESS GAS®

AIR VENTS

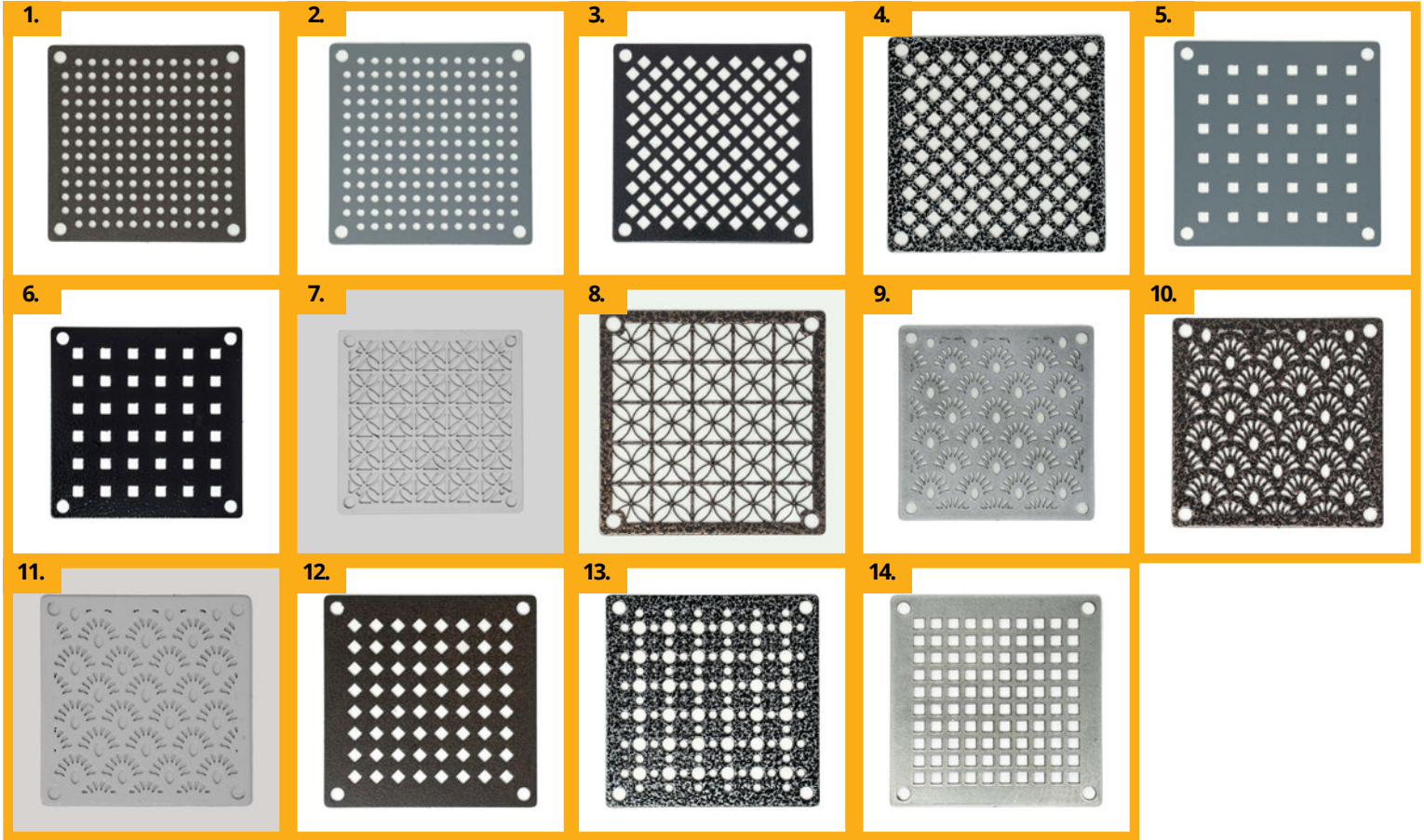

Air Vents & Part Numbers

NUMBER	PART NUMBER	DIMENSIONS	PART NUMBER	DIMENSIONS	AVAILABLE MATERIALS
1	OPT-FPAVENT1	4" x 4"	OPT-FP48AVENT1	4" x 8"	Stainless Steel & Powder Coat
2	OPT-FPAVENT2	4" x 4"	OPT-FP48AVENT2	4" x 8"	Stainless Steel & Powder Coat
3	OPT-FPAVENT3	4" x 4"	OPT-FP48AVENT3	4" x 8"	Stainless Steel & Powder Coat
4	OPT-FPAVENT4	4" x 4"	OPT-FP48AVENT4	4" x 8"	Stainless Steel & Powder Coat
5	OPT-FPAVENT5	4" x 4"	OPT-FP48AVENT5	4" x 8"	Stainless Steel & Powder Coat
6	OPT-FPAVENT6	4" x 4"	OPT-FP48AVENT6	4" x 8"	Stainless Steel & Powder Coat
7	OPT-FPAVENT7	4" x 4"	OPT-FP48AVENT7	4" x 8"	Stainless Steel & Powder Coat
8	OPT-FPAVENT8	4" x 4"	OPT-FP48AVENT8	4" x 8"	Stainless Steel & Powder Coat
9	OPT-FPAVENT9	4" x 4"	OPT-FP48AVENT9	4" x 8"	Stainless Steel & Powder Coat
10	OPT-FPAVENT10	4" x 4"	OPT-FP48AVENT10	4" x 8"	Stainless Steel & Powder Coat
11	OPT-FPAVENT11	4" x 4"	OPT-FP48AVENT11	4" x 8"	Stainless Steel & Powder Coat
12	OPT-FPAVENT12	4" x 4"	OPT-FP48AVENT12	4" x 8"	Stainless Steel & Powder Coat
13	OPT-FPAVENT13	4" x 4"	OPT-FP48AVENT13	4" x 8"	Stainless Steel & Powder Coat
14	OPT-FPAVENT14	4" x 4"	OPT-FP48AVENT14	4" x 8"	Stainless Steel & Powder Coat

Got a custom design in mind?
We will make it for you!

Contact us at
custom@theoutdoorplus.com

Customizing your ventilation!

If you are looking for more than a simple vent for your fireplace, we have these designs available upon request! Each design is available in either Stainless Steel or one of our 7 available Powder Coat Colors.

If you're customizing your fire pit from scratch, go all the way and also customize your ventilation!



THE OUTDOOR PLUS

USA MANUFACTURER OF FIRE & WATER FEATURES

Clearance From Combustibles.

This diagram applies to all fire pits and fire features

Flooring

All fire pits and fire features must be installed on non-combustible flooring. If the fire feature is installed on a combustible floor, such as wood decking, a non-combustible floor paneling **MUST** be properly installed underneath.

Installation

We suggest that our products be installed by professionals that are locally licensed by the authority having jurisdiction in gas piping.

Service

We suggest that our products be serviced by a professional certified in the US by the National Fireplace Institute (NFI) as NFI Gas Specialists

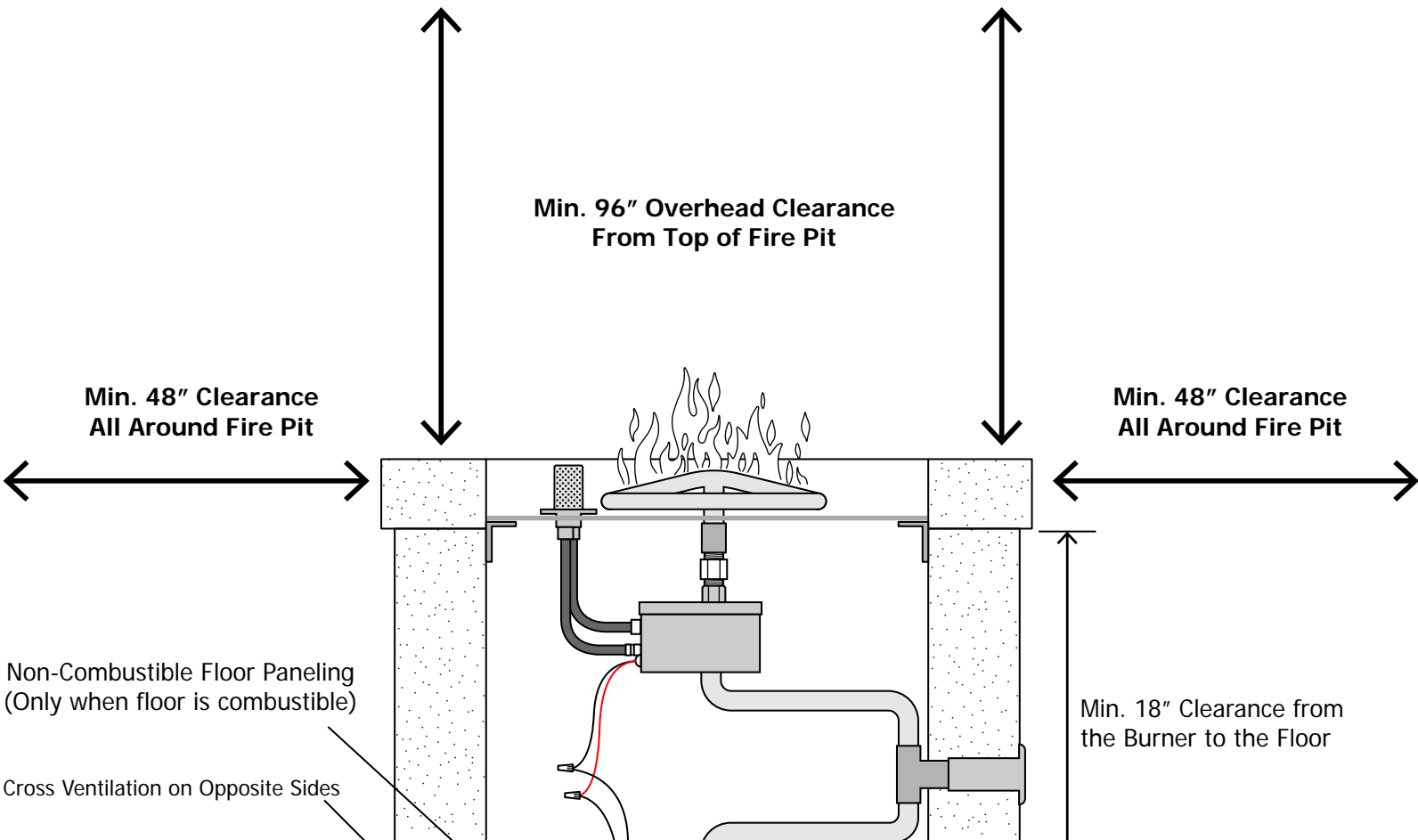

OUR MANUFACTURING CAPABILITIES INCLUDE

- » BOWLS
- » FIRE PITS & TABLES
- » FIRE & WATER FOUNTAINS
- » GAS TORCHES
- » SCUPPERS
- » ACCESSORIES
- » PAN & BURNER KITS
- » BULLET BURNERS®
- » IGNITION SYSTEMS

THEOUTDOORPLUS.COM
909-460-5579



@THEOUTDOORPLUS



VISIT US ONLINE!
Scan the code by opening
your phones camera and
pointing it at the QR Code