

Shower U Bracket 10mm Glass

Nero

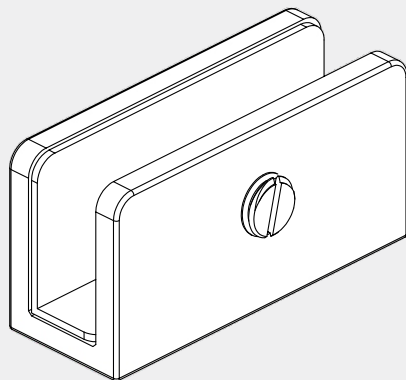

Versions:202401



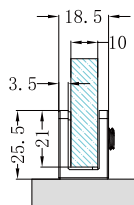
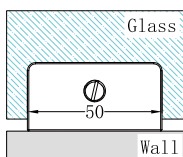



Drawing



Specifications

1. 90 degree wall to glass fixing bracket.
2. Use to fixing glass.
3. Suitable for 10mm glass.
4. Manufactured from high quality brass.

Finish & SKU

- | | | |
|---|--|--|
|  Chrome
NRSH203aCH |  Gun Metal
NRSH203aGM |  Brushed Bronze
NRSH203aBZ |
|  Matte Black
NRSH203aMB |  Brushed Gold
NRSH203aBG |  Brushed Nickel
NRSH203aBN |

*Dimensions are nominal measurements only.

INSTALLATION STEPS

Step 1: Put the plastic plug insert to wall, after put M5 screw use phillips screwdriver tighten screw.

Step 2: Use force slotted screwdriver loosen the screw.

Step 3: Insert to glass, then lock the screw.

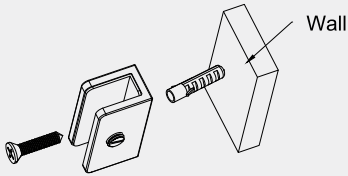

step 1

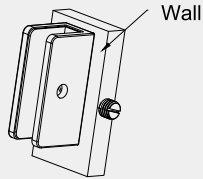

step 2

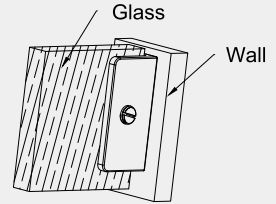

step 3

MAINTENANCE AND CARE

All surfaces should be cleaned with mild liquid detergent or soap and water.

Do not use cream cleaners or citrus based cleaning products, as they are abrasive.

Use of unsuitable cleaning agents may damage the surface.

Any damage caused in this way will not be covered by warranty.

NOTE:

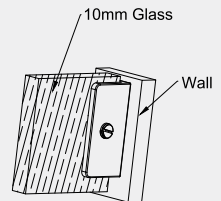

Only use for 10mm glass

Nero