

# Shower F Bracket 10mm Glass

# Nero

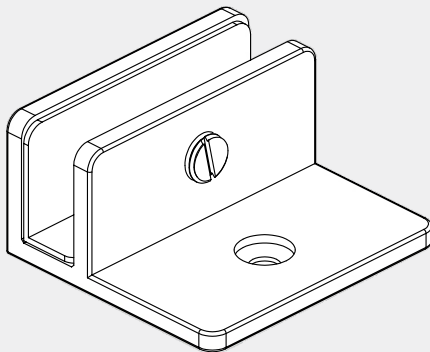

Versions:202401



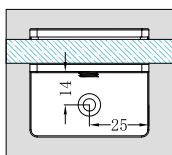
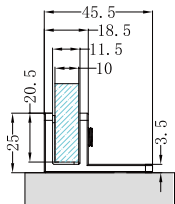
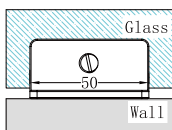



## Drawing



## Specifications

1. 90 degree wall to glass fixing bracket.
2. Use to fixing glass.
3. Suitable for 10mm glass.
4. Manufactured from high quality brass.

## Finish & SKU

- |   |  |  |
|---|--|--|
|  Chrome<br>NRSH202aCH      |  Gun Metal<br>NRSH202aGM    |  Brushed Bronze<br>NRSH202aBZ |
|  Matte Black<br>NRSH202aMB |  Brushed Gold<br>NRSH202aBG |  Brushed Nickel<br>NRSH202aBN |

\*Dimensions are nominal measurements only.

## INSTALLATION STEPS

Step 1: Use force slotted screwdriver to loosen the screw.

Step 2: Insert to glass, then lock the screw.

Step 3: Put the plastic plug insert to wall, after put M5 screw. Use Phillips screwdriver to tighten screw.

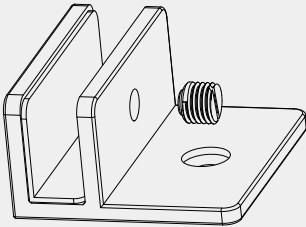

step 1

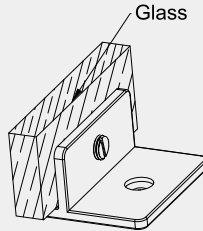

step 2

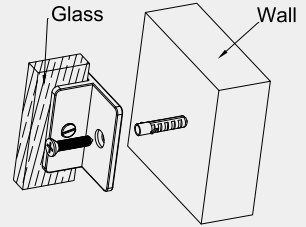

step 3

## MAINTENANCE AND CARE

All surfaces should be cleaned with mild liquid detergent or soap and water.

Do not use cream cleaners or citrus based cleaning products, as they are abrasive.

Use of unsuitable cleaning agents may damage the surface.

Any damage caused in this way will not be covered by warranty.

### NOTE:

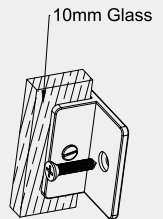

Only use for 10mm glass

# Nero