

LIBERTY DDA TOILET BACK REST

Stock Code(s)

White Cushion - NRCR0001

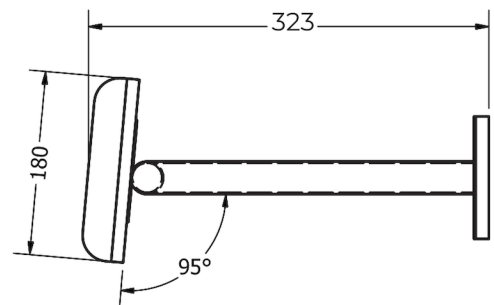
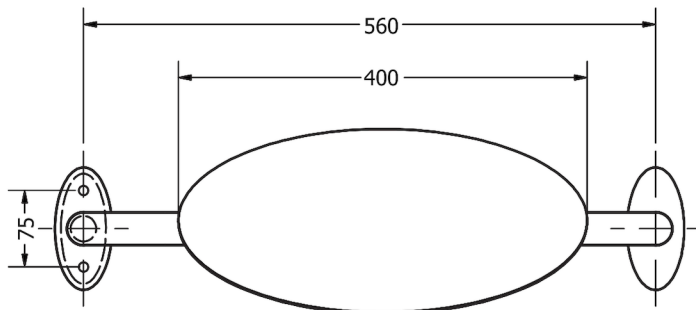
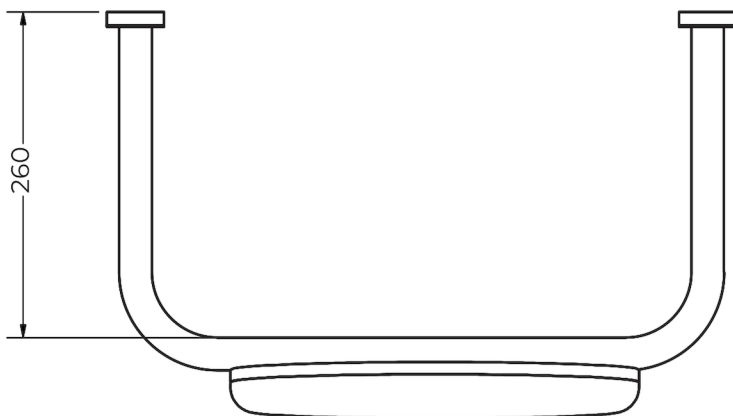

Australian Standard
AS1428.1-2009,
2021 Design for
Access & Mobility
Approved



Tested by a NATA
accredited laboratory
Novitatech

AVAIL QUALITY DESIGNS

- Australian owned and designed
- High quality, high strength materials and finishes
- Backrest cushion available in satin white or black, standard shape is oval but also available in rectangular upon request
- Wall bracket and rail are available in a range of standard or custom finishes
- Comfortable waterproof cushion
- 110kg capacity in each direction
- AS1428.1 Approved for DDA Bathrooms, see diagram for correct install location



WWW.AVAIL.DESIGN



INFO@AVAIL.DESIGN



1300 945 720

LIBERTY DDA TOILET BACK REST INSTALLATION INSTRUCTIONS

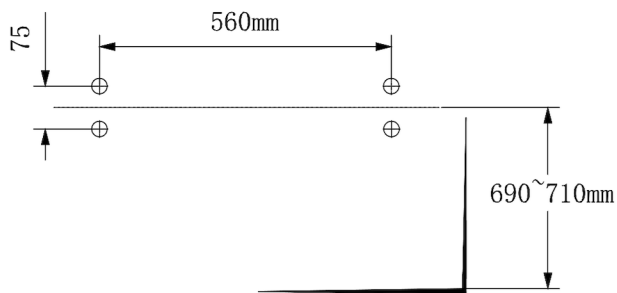

1. Before beginning installation, ensure that the wall is suitable for installing the backrest. Place the wall fixing plate on the wall at the correct height over the center of a stud and mark hole positions on the wall (refer to above picture). Tip: The backrest should be installed at a height of 690-710mm above ground level.

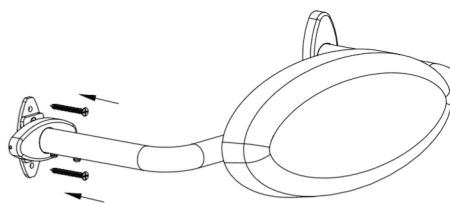

6. Secure the wall mounting plate and rails onto the wall.

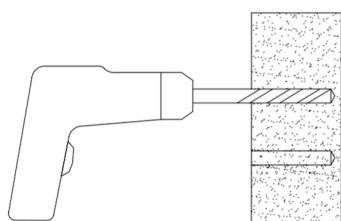

wall plugs

2. Drill pilot holes into the wall stud to a depth of approximately 60mm in order to accommodate mounting screws (and wall plugs if necessary). Tip: Use 3mm hole for screws into timber or 8mm hole for wall plugs.

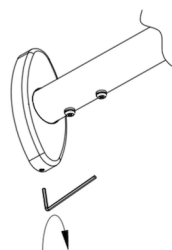

7. Reposition the cover plates onto the wall fixing plate and secure them by tightening the grub screw with an Allen key.

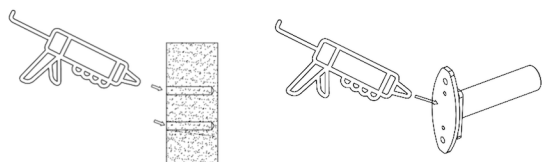

3. Reapply a small quantity of silicone to the wall fixing plate and the surrounding areas of the screw holes

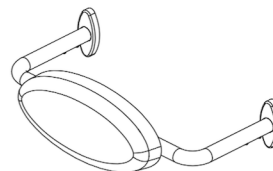

8. Finished.

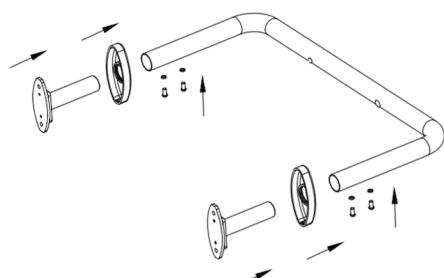

4. Slide the cover plate onto the rail, followed by inserting the wall fixing plate into the rail and securing it with a washer and grub screw.

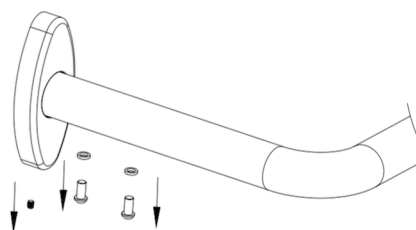

9. Backrest can be removed, if you want. Loosen screws on rails and screws on cover plates. And take off rail and plates.

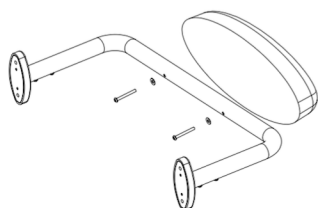

5. Tighten the backrest onto rail by washer and screws.

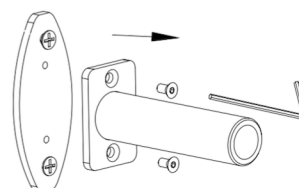

10. Loosen the screws on brackets (refer to above picture). Then you can take off the backrest.

