

# CALIBRE CORNER GRAB RAIL

## Ergo 25mm Diameter Corner Rail



### STOCK CODE(S)

25mm Ergo 215 - NRRC2508W

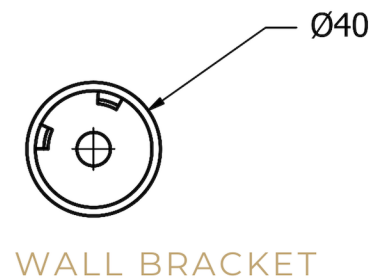
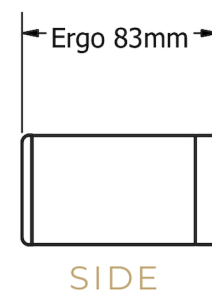
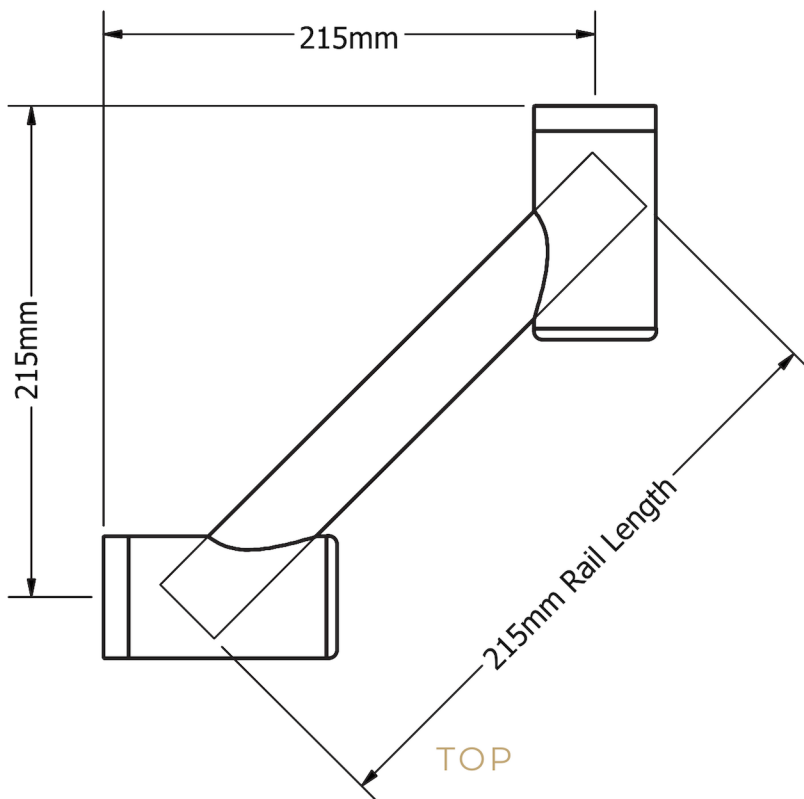

### AVAIL QUALITY DESIGNS

- Australian Owned and Designed
- The corner rail can be mounted at waist height as a grab rail or lower as a foot rest
- Available in over 7 finishes including Living Brass, Chrome, Matt Black, Gunmetal, Brushed Nickel, Bronze, Gold
- Modular design, the rail to be cut down to suit your bathroom
- 150 kg capacity for all 25mm diameter calibre grab rails
- Ergo 25mm diameter rails are suitable for private homes, assisted living and bathrooms where full AS1428.1 compliance is not required



WWW.AVAIL.DESIGN



INFO@AVAIL.DESIGN





1300 945 720

# Calibre 25mm Ergo Rail

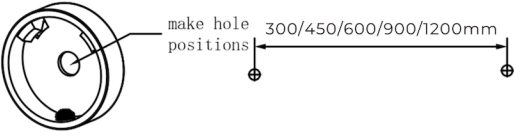
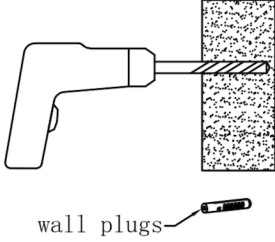
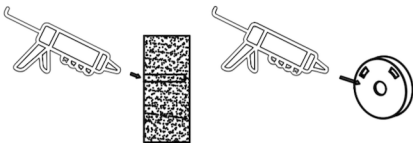

## INSTALLATION INSTRUCTIONS

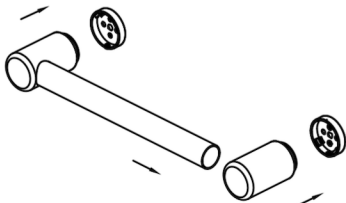
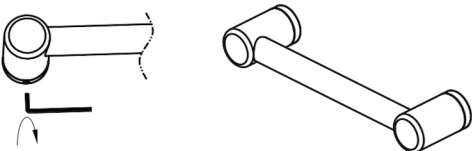
	<p>1. Locate wall studs, install into at least one stud. Place wall seal/mounting bracket on wall at correct height over centre of stud and mark hole positions on wall.</p>
	<p>2. Drill pilot holes into wall stud approximately 60mm deep to suit mounting screws (and wall plugs if required).</p> <p>Tip: 4mm hole for screws into timber or 10mm hole for wall plugs.</p>
	<p>3. Apply small amount of silicon to mounting bracket and wall in and around the screw holes.</p>
	<p>4. Install mounting brackets by screwing onto wall.</p> <p>Tip: Use appropriate mounting screws for the wall stud material, supplied screws are for timber wall studs.</p>
	<p>5. Slide rail tube into end bracket and push onto wall brackets.</p> <p>Tip: Rail length can be cut down to a smaller size, simply use an angle grinder, hacksaw or pipe cutter then deburr the end with a file or grinder and reinsert into the end bracket.</p>
	<p>6. Tighten grub screws with Allen key.</p> <p>Tip: If rail rattles, loosen end bracket, twist slightly and tighten.</p>

### WARNING

These rails are designed to be mounted onto wall studs or masonry walls. Installation is recommended to be completed by qualified trades person who complies with the AS 1428.1-2009 design for access and mobility standard.

It is recommended rail location is determined by a qualified occupational therapist or trained professional to the AS 1428.1-2009 standard. Correct installation is required to ensure safe, long term operation. Incorrect mounting can result in reduced capacity of the rail which can result in injury to user and damage to the wall.

