

CALIBRE ROBE HOOK

Stock Code(s): NRCCR2582

Handy to hang up your robe, towel, handbag or walking stick. Calibre rails can be removed and replaced with this robe hook to make rooms more adaptable, available in colours to match

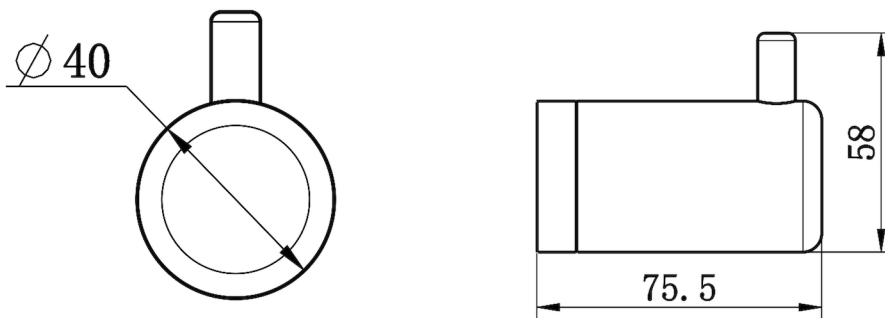
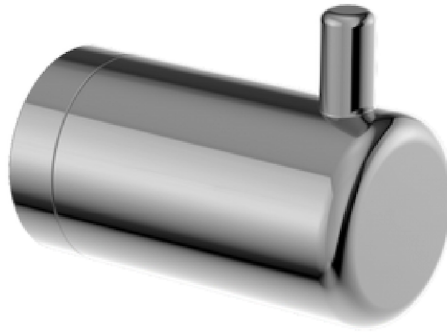

AVAIL QUALITY DESIGNS

- Australian Owned and Designed
- Available in over 7 finishes including Living Brass, Chrome, Matt Black, Gunmetal, Brushed Nickel, Bronze, Gold



WWW.AVAIL.DESIGN





INFO@AVAIL.DESIGN



1300 945 720

Calibre Robe Hook

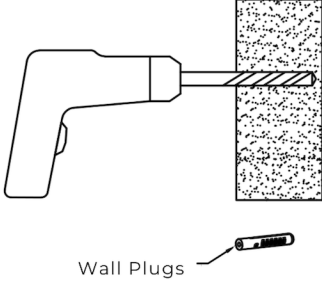
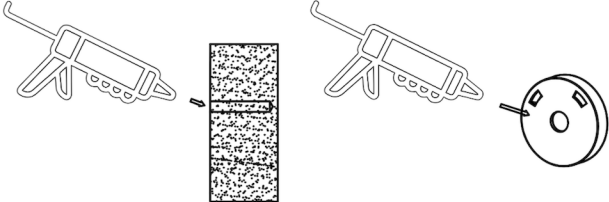
INSTALLATION INSTRUCTIONS

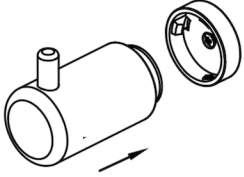
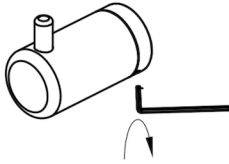
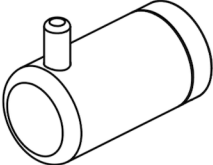
 <p>Make hole positions</p>	<p>1. Locate wall studs, install into stud. Place wall seal/mounting bracket on wall at correct height over centre of stud and mark hole positions on wall.</p>
 <p>Wall Plugs</p>	<p>2. Drill pilot holes into wall stud approximately 60mm deep to suit mounting screws (and wall plugs if required).</p> <p>Tip: 4mm hole for screws into timber or 10mm hole for wall plugs.</p>
	<p>3. Apply small amount of silicon to mounting bracket and wall in and around the screw hole.</p>
	<p>4. Install mounting bracket by screwing onto wall.</p> <p>Tip: Use appropriate mounting screws for the wall stud material, supplied screws are for timber wall stud.</p>
	<p>5. Push wall hook onto wall bracket.</p>
	<p>6. Tighten grub screws with allen key.</p>
	<p>7. Finished.</p>