

babybrezza®

one step
food maker
deluxe

Controls + Indicator Icons

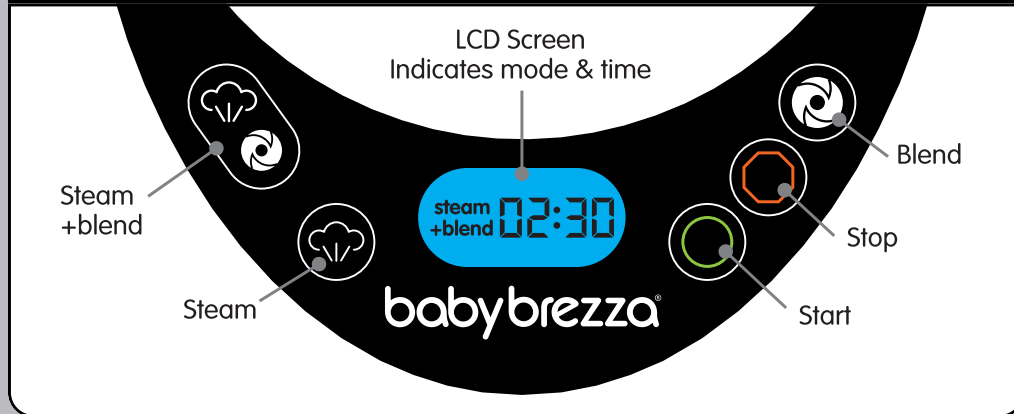

babybrezza®

Customer Service

If you are experiencing problems with your Baby Brezza, visit babybrezza.com/pages/international to locate your local customer service representative.



babybrezza.com

© 2019 Baby Brezza Enterprises LLC

INSTRUCTIONS

IMPORTANT SAFEGUARDS

When using electrical appliances, basic safety precautions should always be followed, including the following:

1. Read all instructions before using.
2. Do not touch hot surfaces. Use handles or knobs.
3. To protect against electric shock do not immerse cord, plug or appliance in water or other liquid.
4. This appliance is not intended for use by persons (including children) with reduced physical, sensory, or mental capabilities, or lack of experience and knowledge, unless they are closely supervised and instructed concerning use of the appliance by a person responsible for their safety. Close supervision is necessary when any appliance is used by or near children. Children should be supervised to ensure that they do not play with the appliance.
5. Turn the appliance OFF, then unplug from the outlet when not in use, before assembling or disassembling parts and before cleaning. To unplug, grasp the plug and pull from the outlet. Never pull from the power cord. Permanently Installed – Make sure appliance is OFF when not in use, before putting on or taking off parts, and before cleaning.
6. Do not operate any appliance with a damaged cord or plug or after the appliance malfunctions, or is dropped or damaged in any manner. Contact the manufacturer at their customer service telephone number for information on examination, repair, or adjustment.
7. The use of accessory attachments not recommended by the appliance manufacturer may cause fire, electric shock or injury.
8. Use on level surface and be sure there is no debris under the unit and the rubber pads are touching the surface.
9. Household use only. Do not use outdoors.
10. Do not let cord hang over edge of table or counter, or touch hot surfaces.
11. Do not place on or near hot gas or electric burner, or in a heated oven.
12. Extreme caution must be used when moving an appliance containing hot liquids.
13. Do not use appliance for other than intended use.
14. Do not use the machine without food in the bowl.
15. This appliance has a polarized plug (one blade wider than the other). To reduce risk of electric shock, this plug is intended to fit into a polarized outlet only one way. If the plug does not fit fully into the outlet, reverse the plug. If it still does not fit, contact a qualified electrician. Do not attempt to modify the plug in any way.
16. Make sure machine is turned off before unplugging.
17. A short powder-supply cord should be used to reduce the risk of becoming entangled in or tripping over a longer cord. Extension cords are available and may be used if care is exercised in their use.
18. If using the machine with an extension cord, make sure the cord is the proper electrical rating for the machine. The marked electrical rating of the cord set or extension cord should be at least as great as the electrical rating of the appliance. The extension cord should be arranged so that it does not drape over countertop or tabletop where it can be pulled on by children or tripped over unintentionally.
19. Before serving, be sure food is at safe temperature.
20. Avoid contact with moving parts. Never remove lid while blade is moving.
21. Blade has 4 cutting edges and is sharp. Handle carefully. Install and remove by handling top of plastic column. Bowl must be in place before replacing the blade.
22. Do not disassemble or lubricate drive shaft.
23. The appliance is intended for processing small quantities of food and is especially recommended for preparing baby food. The appliance is not intended to prepare large quantities of food at a time.
24. Do not blend hard foods in this machine. Use the steam + blend function for hard foods such as carrots and potatoes. Use the blend only function for soft foods such as bananas and berries.
25. To disconnect from power source, press stop button to turn off any function and remove plug from wall outlet.
26. Before serving, unplug cord from wall outlet. Do not leave cord within child's reach.



Correct Disposal of this product. This marking indicates that products should not be disposed of with other household wastes. To prevent possible harm to the environment or human health from uncontrolled waste disposal, recycle it responsibly to promote the sustainable reuse of material resources. To return your used device, please use the return and collection systems or contact the retailer where the product was purchased. They can take this product for environmentally safe recycling.

SAVE THESE INSTRUCTIONS

Get to know your Deluxe One Step Baby Food Maker

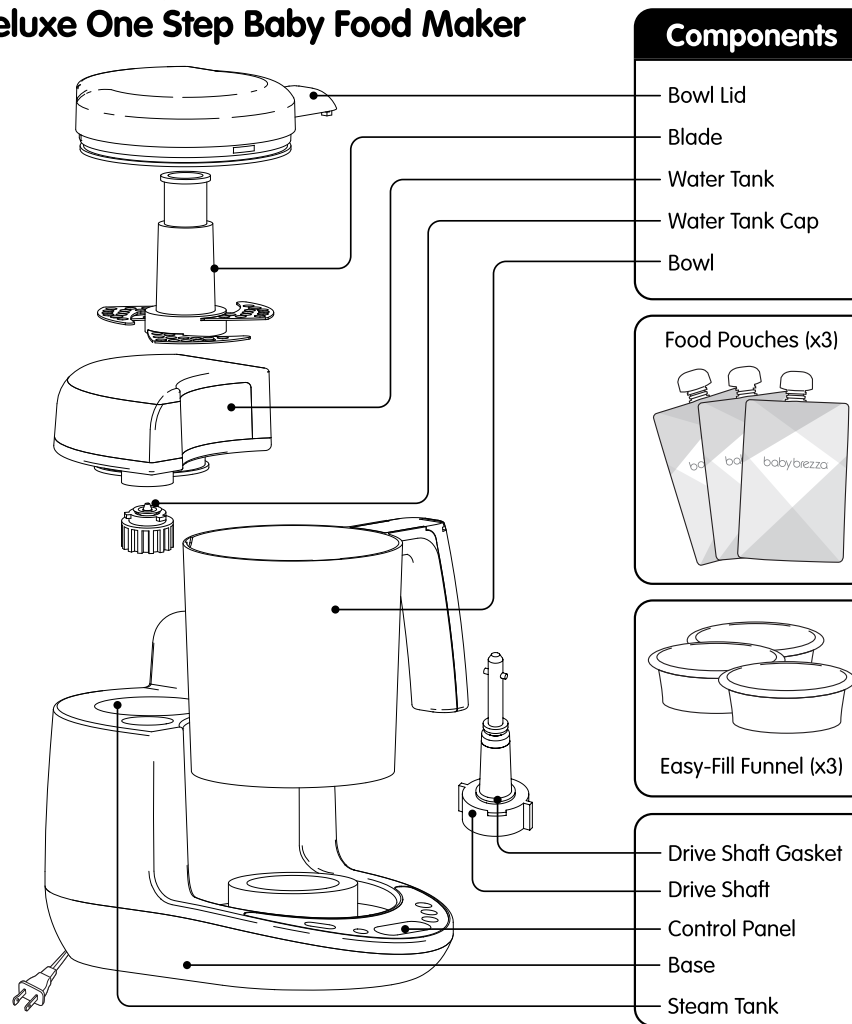

Safety Switch Function

If the Bowl Lid is opened or the Bowl is removed from the Base during operation, the machine will automatically shut off and beep rapidly. If the Lid and Bowl are replaced within 5 seconds after removal, the machine will resume operation, otherwise it will return to standby mode.

Overheating Protection

If the Steam Chamber runs dry during operation, the heater will shut off and the machine will beep rapidly 5 times. Add water to the Water Tank to resume operation.

TECHNICAL DATA

| | |
|----------------------------------|----------------------------------|
| Model: BRZ00141 | Motor Power: 150W |
| Supply voltage: 220-240V 50~60Hz | Current: 3.5A Heater Power: 400W |

How to Use - Clean all parts before first use

1 To remove water tank, press the release button and lift the water tank up.

2 Remove water tank cap and fill the water tank.

3 After filling, place water tank back onto base. Push down firmly until water tank clicks into place.

4 Place blade in bowl by dropping the blade on the driveshaft.

5 Add chopped ingredients to the bowl. Refer to recipe guide for measurements.

6 Choose the desired settings. See back page for control panel details

CAUTION Do not lock in the Blade by turning it or pushing it down.

CAUTION Always make sure driveshaft and driveshaft gasket are properly inserted into bowl before steaming or blending. Use of the machine without the driveshaft and gasket will result in water damage to the base.

Top View

To place lid on bowl, position the lid as shown above, then rotate lid counter-clockwise. Make sure tabs on cover align with slots on front of bowl, handle and base of machine.

Attaching Lid and Bowl

Turn bowl counter-clockwise to lock on to base. Turn lid counter-clockwise to lock on to bowl.

Turn bowl clockwise to release from base. Turn lid clockwise to release from bowl.

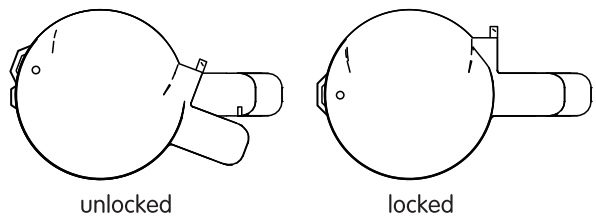

Cooking & Controls

Steam + Blend - Automatically blend after steaming

Press repeatedly until desired cooking time is selected. Each press adds 5 minutes to the steam time. Max time is 30 minutes.

Press to begin the steam + blend cycle. Once the steam cycle is complete, the blend cycle will run for 30 seconds and the machine will shut off.

For a smoother consistency, press and hold to blend more. Make sure bowl lid is locked onto bowl. Do not remove lid when blade is moving.

Steam Only

If you would like to steam without the automatic blend cycle, press repeatedly until desired steam time is selected.

Press to begin steam cycle. Machine will beep 3 times and shut off when steam cycle is complete.

Blend Only

Make sure bowl lid is locked onto bowl. Press and hold until desired consistency is achieved. Do not remove lid when blade is moving.

Reheat & Defrost

Use the steam function to reheat and defrost. See **Steam Only** instructions above.

Filling the Food Pouch

1

Open zipped side of food pouch.

2

Place funnel into food pouch.

3

Make sure pouch cap is tightened securely. Carefully pour food through the funnel.

4

Pinch the zipper to seal the food pouch securely.

Cleaning

- Always unplug the appliance before cleaning.
- Clean the appliance, food pouches, and easy fill funnels before and after use.
- Bowl, Blade and Bowl Lid are top shelf dishwasher safe* and can also be hand washed with warm, soapy water. Never use abrasive pads to clean machine parts.
- Stainless steel heating plate can be scrubbed with abrasive pad to remove mineral scaling.
- Never put the Driveshaft in the dishwasher.
- Base and Driveshaft should be wiped with damp cloth only.
- We recommend regular cleaning of the Steam Tank to prevent damage to the machine from mineral deposits. The frequency of cleaning will depend on the type of water you are using and how much mineral deposit build up forms. Always unplug before cleaning. Put 1/3 cup white vinegar and 1/3 cup distilled water in machine and let sit overnight. Pour out vinegar and water solution following instructions below. Refill Steam Tank with purified water, plug in machine and run "Steam" cycle for 15 minutes. Rinse with purified water to eliminate any remaining vinegar taste. Empty any remaining water and refill with purified water before steaming new recipes.
- Never use a chemical descaler in the machine.
- Note: To remove unwanted water from the steam tank, water tank, or lid, see diagram below.
- Any other servicing should be performed by an authorized service representative.

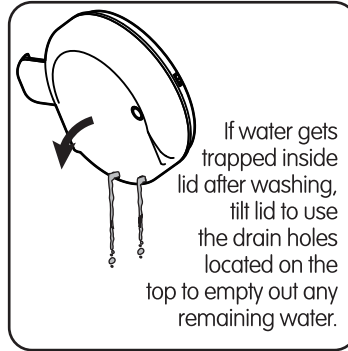
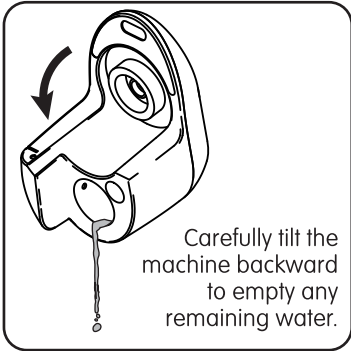

Cleaning the Food Pouch

- The food pouch and easy-fill funnel are top rack, dishwasher safe.
- Thoroughly rinse out the food pouch with soap and water.
- Do not use harsh abrasives to clean the food pouch or easy-fill funnel.
- Allow parts to dry before storing away.

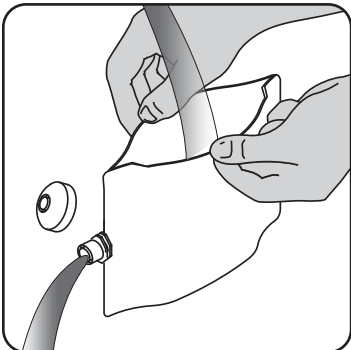

Removing and Replacing the Driveshaft

Remove driveshaft from bowl before cleaning in dishwasher. See illustration.

To remove Driveshaft, turn Knob on bottom of bowl counter-clockwise ↺ and pull out. Wipe drive shaft with damp cloth. Never put driveshaft in dishwasher. Do not misplace Driveshaft Gasket while cleaning. To replace the Driveshaft after cleaning, insert into hole in bottom of bowl and turn clockwise ↻ to lock in place*.

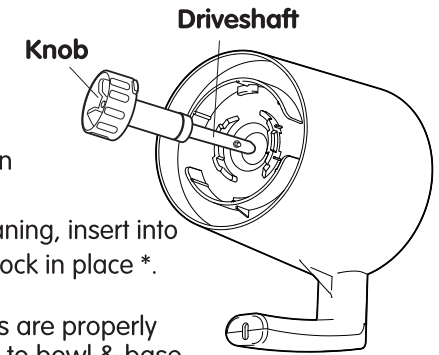

*Always make sure Driveshaft & Driveshaft Gaskets are properly inserted and locked into place to prevent damage to bowl & base.

Troubleshooting

| Condition | Possible Cause | Possible Remedy |
|--------------------------------------|---|---|
| Machine will not start. | Steam Tank is dry. (Machine will beep rapidly 5 times to indicate that the Steam Tank is Dry) | Add water to Water Tank. |
| | Safety tab on Bowl Lid is not fully inserted into Base. | Make sure Bowl Lid is turned counter-clockwise as far as possible and safety tab on Bowl Lid is fully inserted into Base. |
| | Machine is unplugged. | Plug in Baby Brezza. |
| Machine stops during operation | Steam Tank is dry. (Machine will beep rapidly 5 times to indicate that the Steam Tank is Dry) | Add water to Water Tank. |
| | Safety tab on Bowl Lid has been disengaged from Base. | Make sure Bowl Lid is turned counter-clockwise as far as possible and safety tab on Bowl Lid is fully inserted into Base. |
| Final puree consistency isn't smooth | Raw food isn't diced finely enough before steaming. | Dice food into smaller pieces, approximately 1/4"-1/2" (1cm), before placing in bowl. |
| | Low water content of raw food. | Add additional water, formula, breast milk or other liquid after steaming and blend longer. |
| Can not remove Blade from Driveshaft | Blade is in dropped position with driveshaft pins locked in place. | Lock bowl back onto machine. Gently pull up on center blade column while twisting counter-clockwise. |
| Scaling in Steam Tank | Mineral rich water used persistently. | Clean Steam Tank by following instructions on page 5. |