

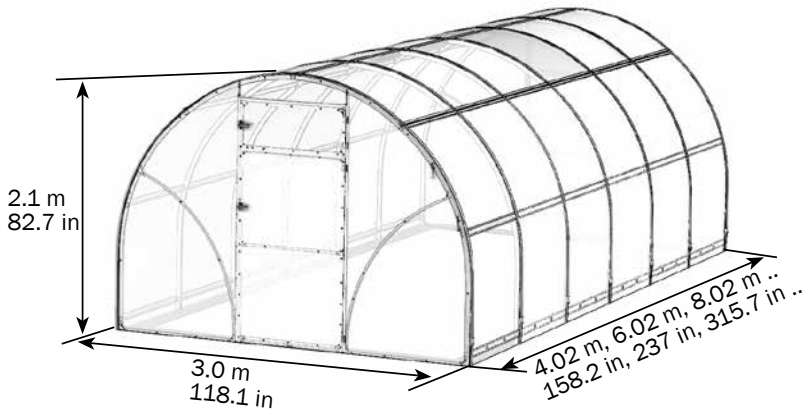

Planta
GREENHOUSES

SIGMA 2021 EURO

Cellular Polycarbonate Greenhouse



Technical certificate

p. 2-9

Assembling manual

p. 11-47



! Perform assembling and operation of the greenhouse in strict accordance with the manual and operating rules stated in the technical certificate. Please keep this technical certificate for further reference.

Description

The greenhouse is intended to create a favorable microclimate for growing garden crops in allotments and kitchen gardens.

The greenhouse is available in different lengths depending on the buyer's choice. The required length of the greenhouse is attained by buying additional packages with extension inserts. Each insert lengthens the standard supply set of the greenhouse by 78.7 in (2 m). The length of the standard supply set is 158.2 in (4.02 m). The height of the installed frame of the greenhouse is 82.7 in (2.1 m).

The frame of the greenhouse is made of galvanized steel pipes and profiles. It is assembled with screws and nuts. The kit comprises everything needed for fixing the glazing. The complete set of the greenhouse includes the glazing at the request of the buyer.

Operation rules

Before starting the operation, the greenhouse should be assembled and installed according to the instruction. When installing the greenhouse by third parties, the buyer should check the assembly quality for compliance with the instruction.

Do not install the greenhouse close to buildings and trees from which snow or ice may fall. The distance of at least 78.7 in (2 m) is recommended.

The greenhouse is designed to withstand the wind speed no more than 24 m/s (54 mph).

The maximum snow load for the framework occurs when the weight of a snow cover is 160 kg per 1 m² of the horizontal surface of the ground surface corresponding to 0.4 m packed snow layer. To increase the bearing capacity under the snow load of the frame of the entire greenhouse up to 360 kg/m², arch reinforcement should be installed on each greenhouse arch, with the exception of the doorway arches (see para.24). The dismantling of the arch reinforcement from the greenhouse frame after the winter period is carried out using one bolted connection.

It is necessary to avoid exceeding the snow load on the greenhouse: either to remove snow from the greenhouse after each snowfall, or remove the greenhouse glazing for winter.

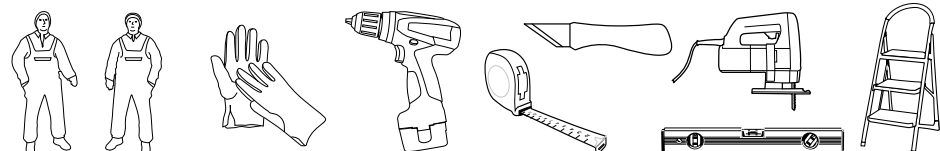

Cleaning and washing sheets of polycarbonate

1. Rinse the sheet with warm water.
2. Wash the sheet with a solution of mild soap or with a household detergent and warm water, using a soft rag or a sponge to remove dirt.
3. Rinse with cold water and wipe with a soft cloth.

Never use abrasives or highly alkaline cleaning compositions for cleaning polycarbonate sheets. Dry rubbing of the surface will damage the protective layer of the cladding and shorten its shelf life. Never rub the surface of polycarbonate sheets with brushes, metallic cloth or other abrasive materials.

When disinfecting the greenhouse from pathogens causing fungal and bacterial diseases, do not use «sulfur blocks» to avoid frame corrosion.

Warranty liabilities

Term for making claims is 24 months from the day of purchase.

Warranty does not apply to cases of:





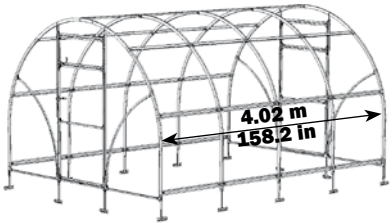
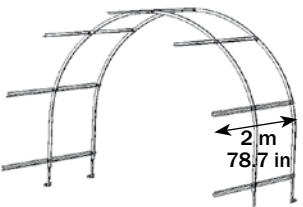

1. Greenhouse installation in violation of instruction requirements
2. Violation of the rules of operation.
3. Inappropriate use of the greenhouse.
4. Deformation of the greenhouse as a result of ground movement.
5. Floods, hurricanes and other natural disasters.



















Production date

LIST OF PARTS FOR ASSEMBLY

















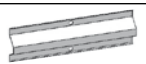



GREENHOUSE	BOX 1	BOX 2	BOX EXTENSION
<p>SIGMA BASELINE MODEL</p> 	+	+	-
<p>EXTENSION FOR GREENHOUSE 78.7 in (2m)</p> 	-	-	+











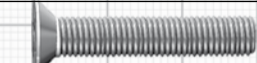

STANDARD SUPPLY SET BOX 1



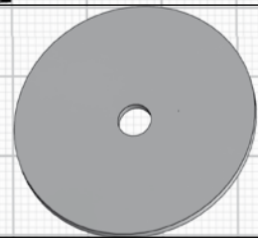



№	marking	denomination	length, in (m)	q-ty, pcs
1	1	Leg 	12.99 in (0.33 m)	10
2	1-2	End wall leg 	10.23 in (0.26 m)	4
3	2	Purlin 	38.58 in (0.98 m)	28
4	8-2	End wall corrugated connecting bar 	58.26 in (1.48 m)	2
5	8-1	End wall connecting bar 	58.26 in (1.48 m)	2
6	9-2	Doorway post for hinges 	78.74 in (2.0 m)	2
7	9-1	Doorway post 	78.74 in (2.0 m)	2

№	marking	denomination	length, in (m)	q-ty, pcs
8	10	Doorway tie 	35.43 in (0.9 m)	2
9	12	Door vertical element for hinges 	58.26 in (1.48 m)	2
10	12-1	Door vertical element 	58.26 in (1.48 m)	2
11	12-2	Window vertical element for hinges 	14.17 in (0.36 m)	2
12	12-3	Window vertical element 	14.17 in (0.36 m)	2
13	13-1	Door/window horizontal element 	33.46 in (0.85 m)	6
14	13	Door horizontal element medium 	33.46 in (0.85 m)	2
15	13-2	Window horizontal element 	33.46 in (0.85 m)	2
16	PK	Profile 	41.33 in (1.05 m)	4
17	P	Profile 	39.37 in (1.0 m)	4
18	Y1	Door lining 	29.52 in (0.75 m)	2
19	Y2	Door lining 	29.52 in (0.75 m)	2
20	Y8	Door lining 	29.52 in (0.75 m)	2
21	Y9	Door lining 	29.52 in (0.75 m)	2
22	Y10	Window lining 	16.14 in (0.41 m)	2
23	Y12	Window lining 	16.14 in (0.41 m)	2
24	Y7	Window lining 	33.46 in (0.85 m)	4
25	0.2	Stand bottom 25x25 	47.24 in (1.2 m)	3
26	0.1	Stand 20x20 	47.24 in (1.2 m)	3

BOX 2

№	marking	denomination	length, in (m)	q-ty, pcs
27	4T	End wall arch 	59.05 in (1.5 m)	4
28	4BT	Upper end wall arch 	74.8 in (1.9 m)	2
29	4HT	Lower end wall arch right 	74.8 in (1.9 m)	2
30	4HT-1	Lower end wall arch left 	74.8 in (1.9 m)	2
31	4B	Upper arch 	74.8 in (1.9 m)	3
32	4H	Lower arch 	74.8 in (1.9 m)	6
33	3	Support 	5.51 in (0.14 m)	14
34	-	Inner clamp 		21
35	-	Outer clamp 		21
36	-	End wall clamp 		14
37	-	Bracket 		3
38	-	40x20 clamp 		12
39	-	40x20 clamp 		12
40	-	20x20 clamp 		24
41	-	20x20 angle clamp 		32
42	-	Hinge 		8
43	-	Handle kit 		4
44	-	Latch 		4
45	-	Stop bar 		4
46	-	Coupler 		3







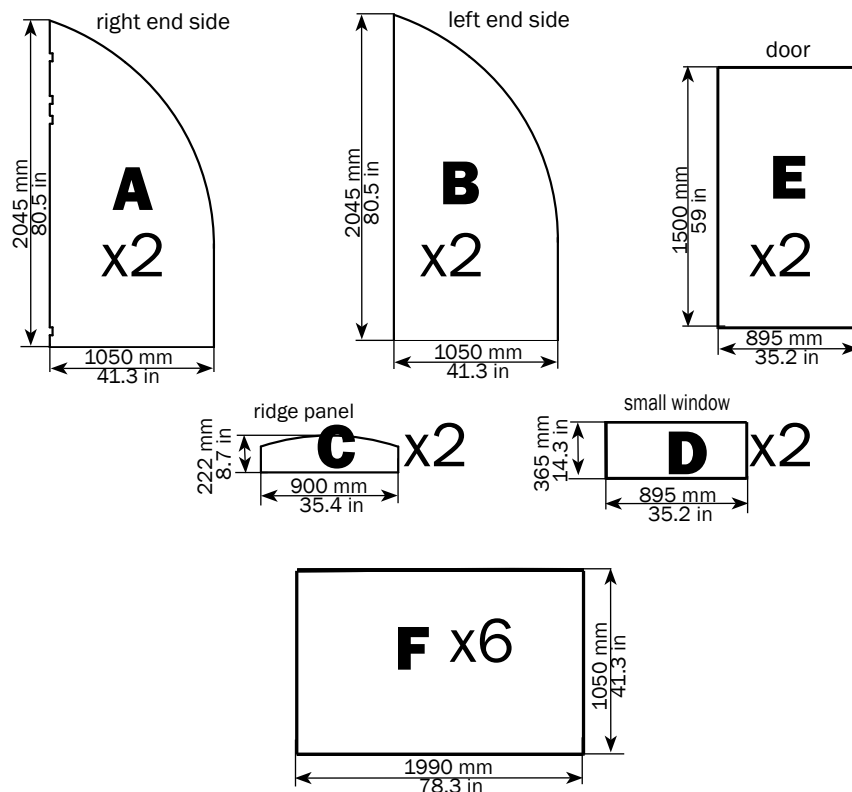



















№	denomination	q-ty, pcs
47	M4x12 screw 	56
48	M4x35 screw 	48
49	M5x30 screw 	34
50	M6x16 screw 	40
51	M5x30 bolt 	3
52	M6x60 bolt 	10
53	4.8x19 self drilling screw 	290
54	32x4 washer 	32
55	M4 nut 	104
56	M5 nut 	45
57	M6 nut 	50
58	6 washer 	20
59	10 washer 	12
60	Self-tapping screw 	28

Nº	denomination	q-ty, pcs
61	Top metal fastening band 	5
62	Bottom metal fastening band 	10
63	Angle bracket 	10
64	Door holder kit (hooks) 	4
65	Adhesive tape 	1
66	Double-sided tape L=10 m 393.7 in 	1

Sigma Polycarbonate Box 1/2



BOX EXTENSION

Nº	marking	denomination	q-ty, pcs
1	4B	Upper arch 	2
2	4H	Lower arch 	4
3	1	Leg 	4
4	2	Purlin 	14
5	3	Support 	4
6	-	Inner clamp 	14
7	0.2	Stand bottom 25x25 	2
8	0.1	Stand 20x20 	2
9	-	Bracket 	2
10	-	Coupler 	2
11	-	Outer clamp 	14
12	-	M4x12 screw 	28
	-	M4x35 screw 	24
	-	M5x30 bolt 	2
	-	M6x60 bolt 	4
	-	M4 nut 	52
	-	M5 nut 	2
	-	M6 nut 	4
	-	32x4 washer 	16
	-	4.8x19 self drilling screw 	44
	-	6 washer 	8
	-	Top metal fastening band 	2
	-	Bottom metal fastening band 	4
	P	Profile L-1000 mm 39.3 in 	4
	-	Angle bracket 	4
	-	Self-tapping screw 	8
	-	Double-sided tape L=5 m 196.8 in 	1

Sigma Polycarbonate Box 2/2 (Extension)

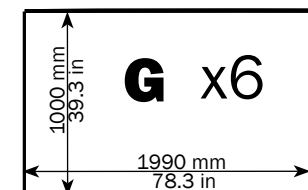

1.1 If the greenhouse is mounted on a foundation (see para. **7.2**), the parts **1** and **3** are not assembled and are not mounted in the subsequent assembly.

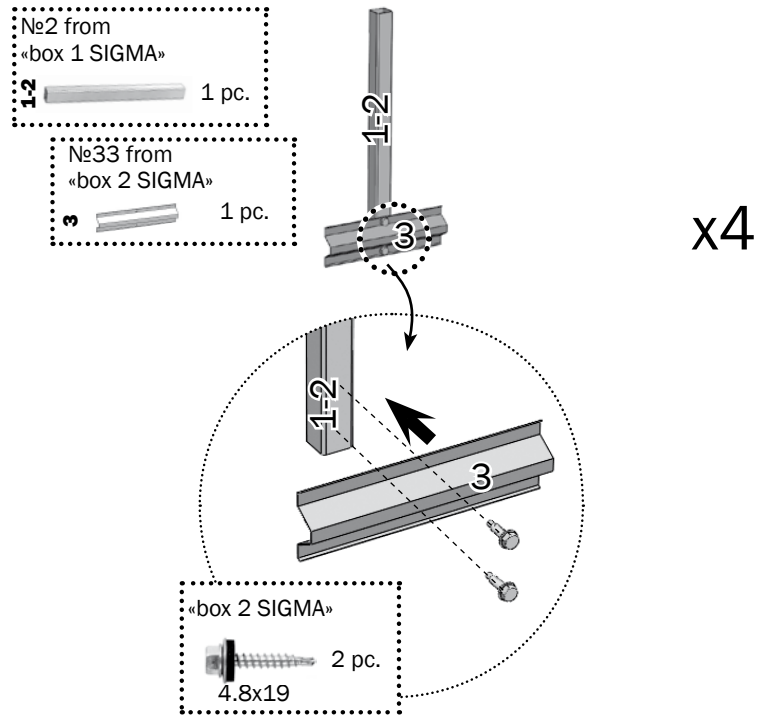

1.2

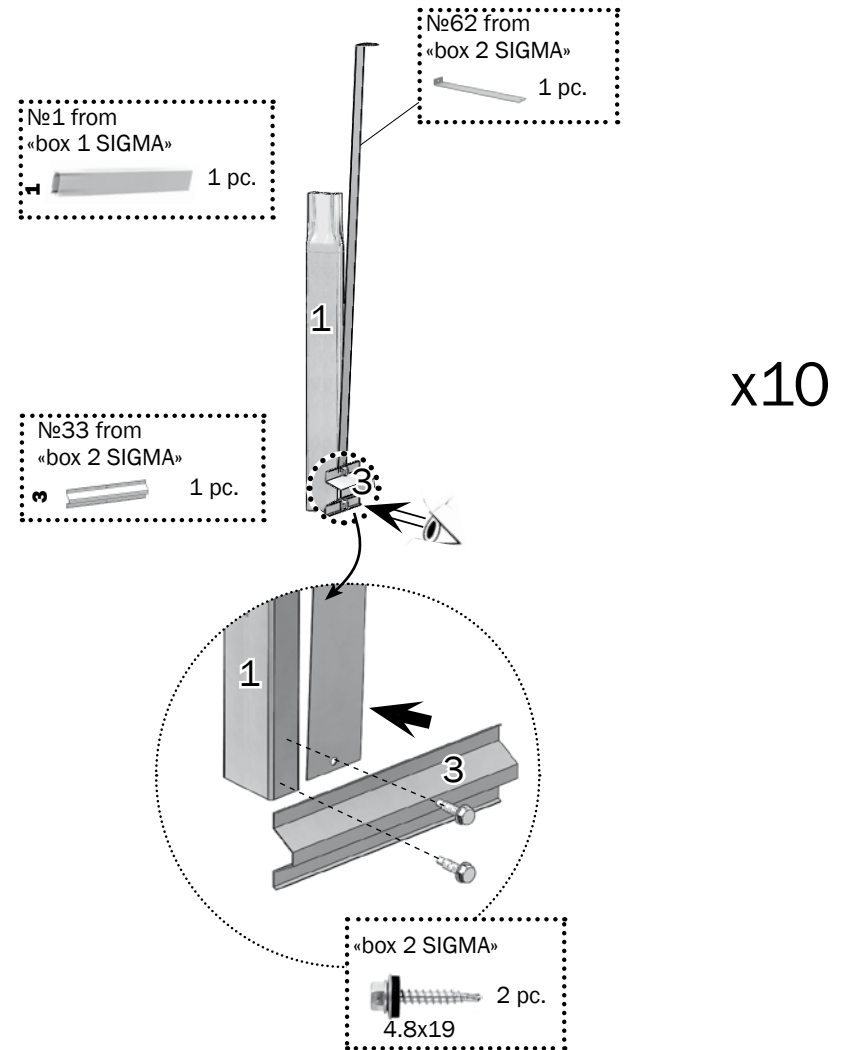

2.1

Inner side of the end wall. Pre-Drilled pin holes are on the backside and will be facing the polycarbonate panels.

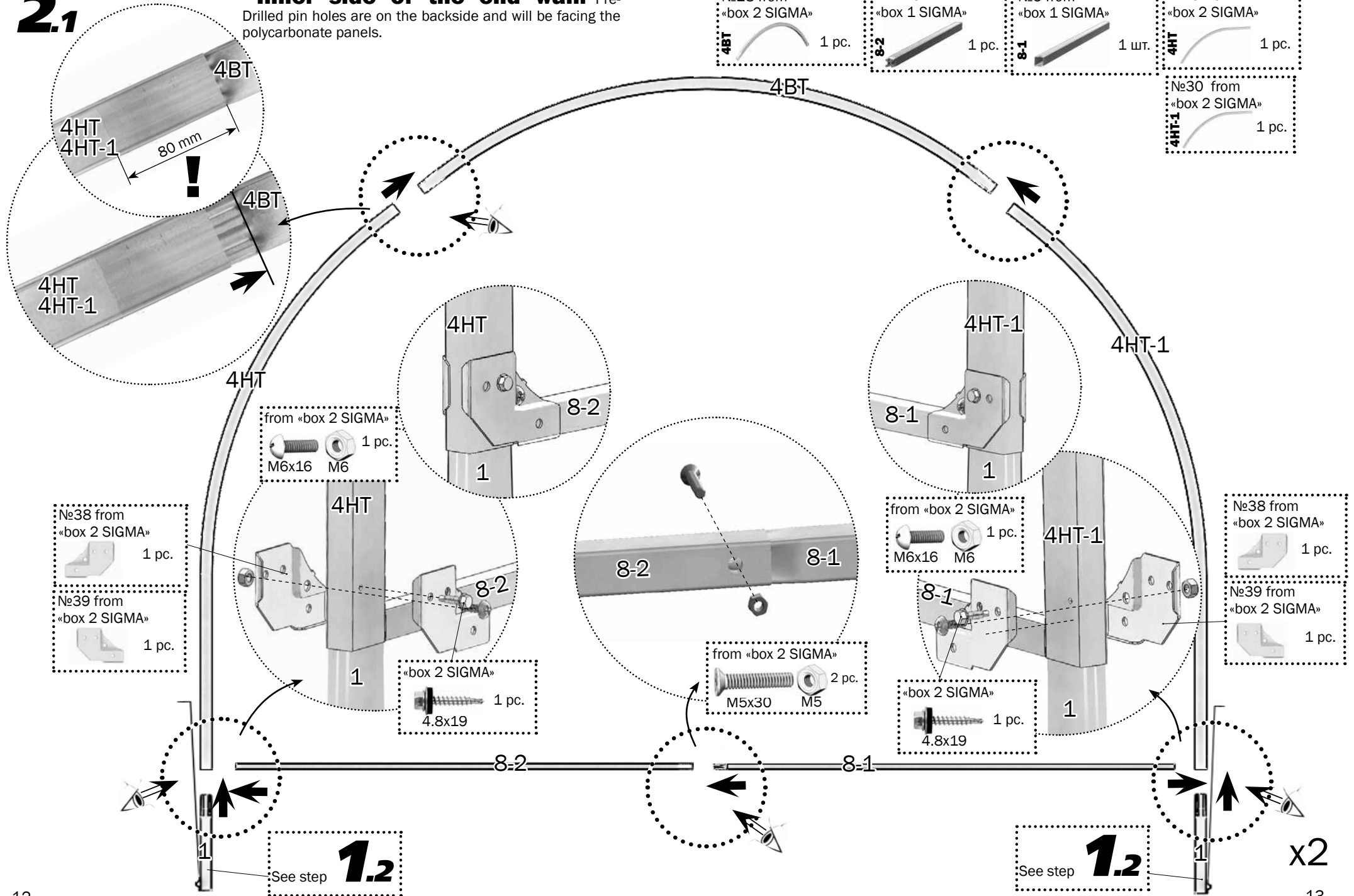

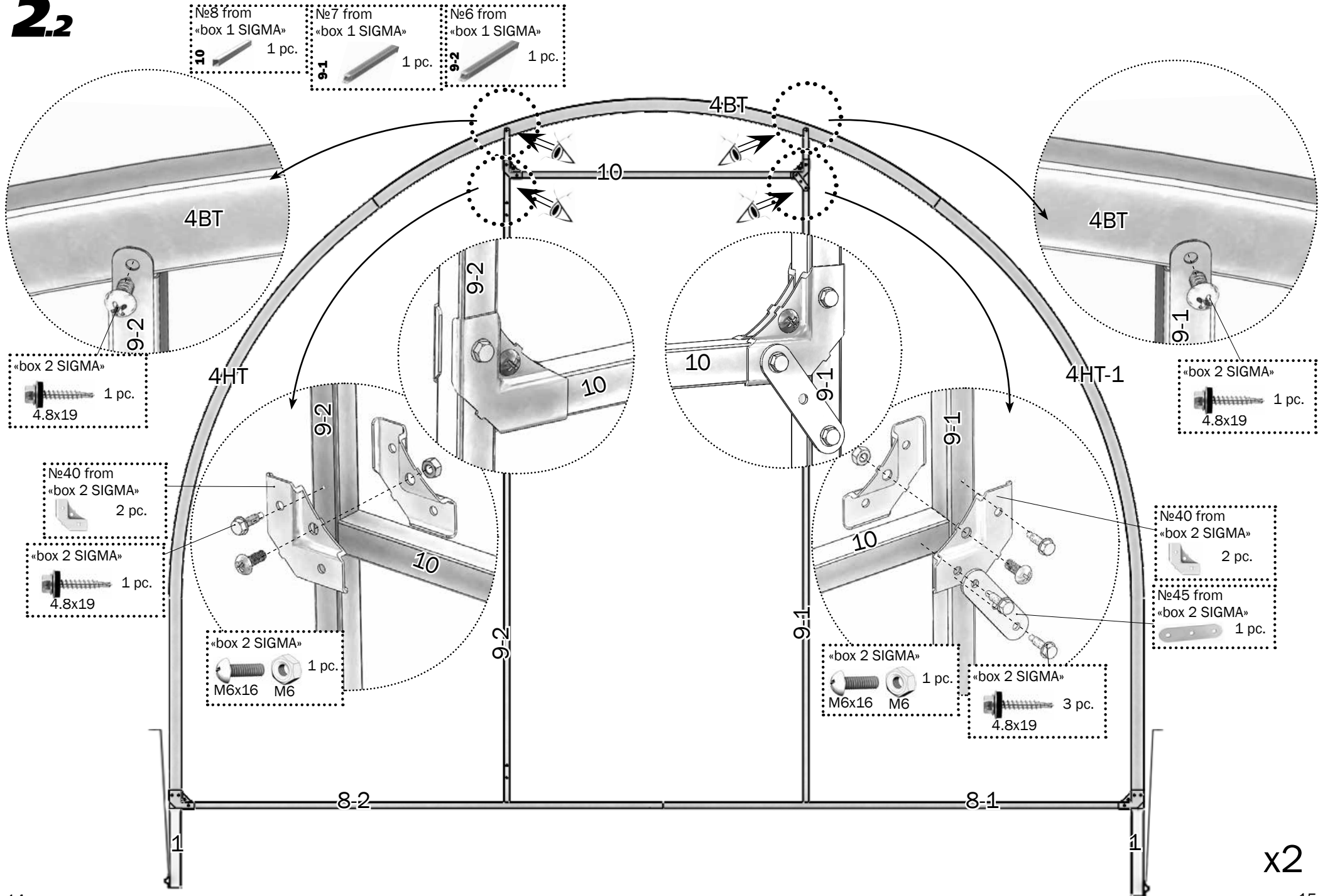

x2

2.3

№38 from «box 2 SIGMA» 1 pc.

№27 from «box 2 SIGMA» 2 pc.

№39 from «box 2 SIGMA» 1 pc.

№38 from «box 2 SIGMA» 1 pc.

«box 2 SIGMA» 1 pc.
M6x16 M6

№39 from «box 2 SIGMA» 1 pc.

«box 2 SIGMA» 1 pc.
M6x16 M6

№39 from «box 2 SIGMA» 1 pc.

«box 2 SIGMA» 4 pc.
4.8x19

№38 from «box 2 SIGMA» 1 pc.

№38 from «box 2 SIGMA» 1 pc.

«box 2 SIGMA» 4 pc.
4.8x19

№40 from «box 2 SIGMA» Only used when installed directly on the ground 2 pc.

№40 from «box 2 SIGMA» Only used when installed directly on the ground 2 pc.

№47 from «box 2 SIGMA» 1 pc.

№39 from «box 2 SIGMA» 1 pc.

«box 2 SIGMA» 2 pc.
M6x16 M6

See step **1.1**

See step **1.1**

x2

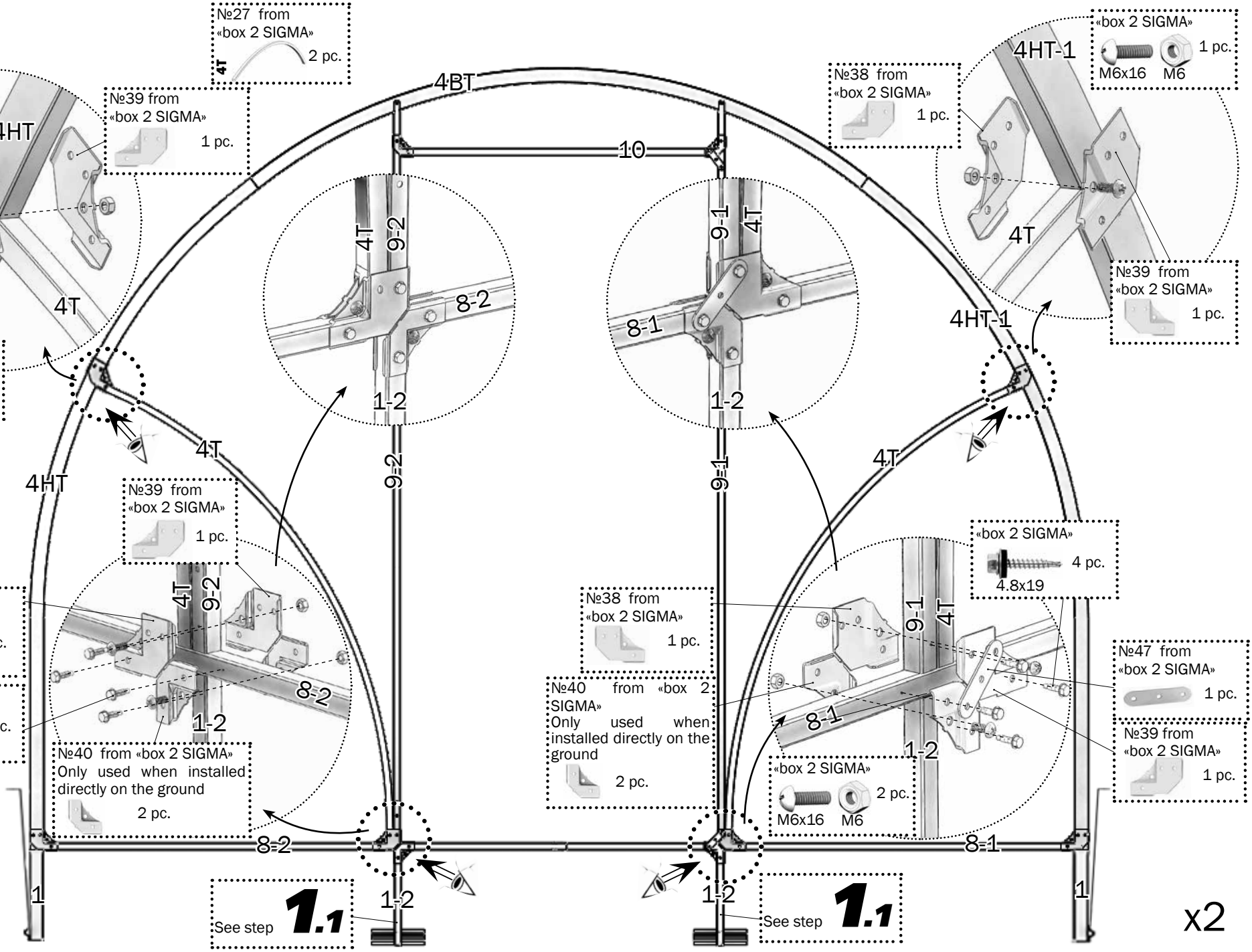

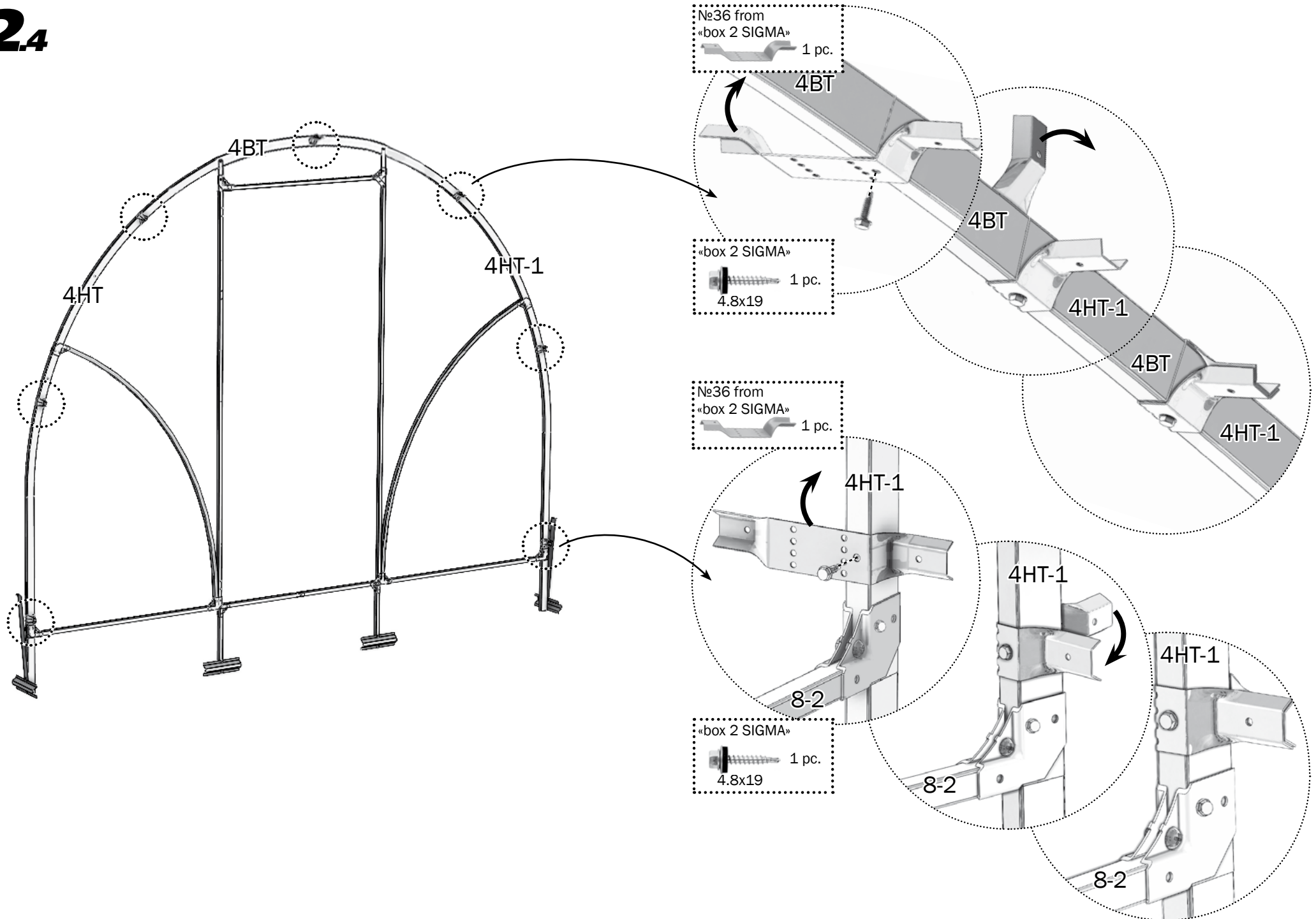

3.1

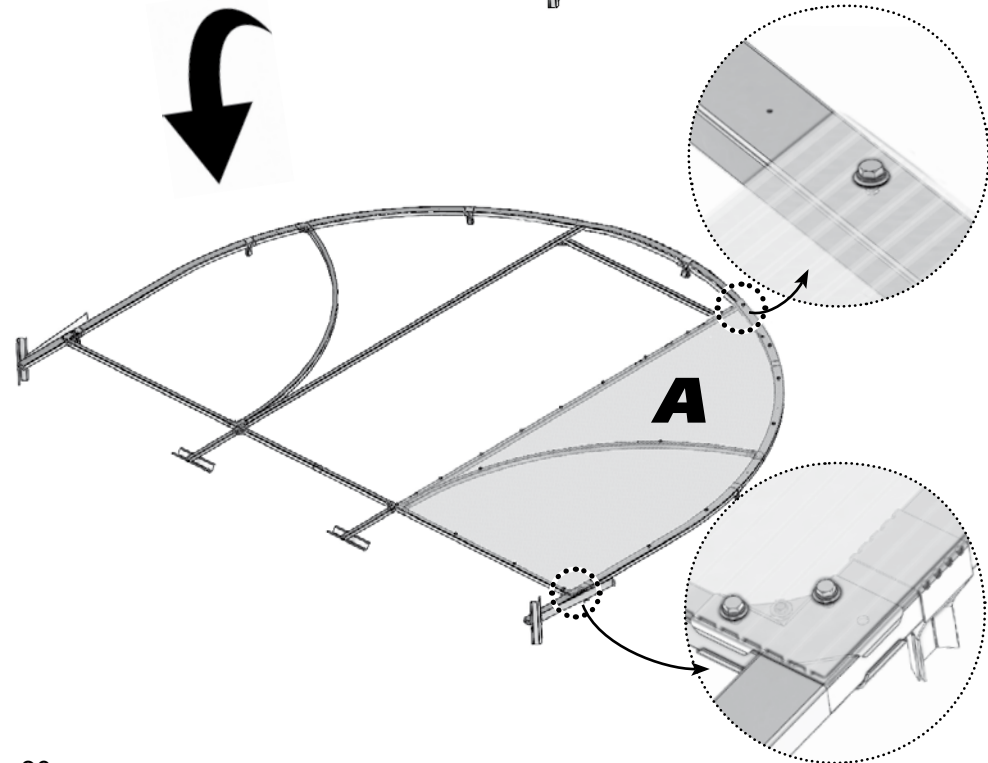
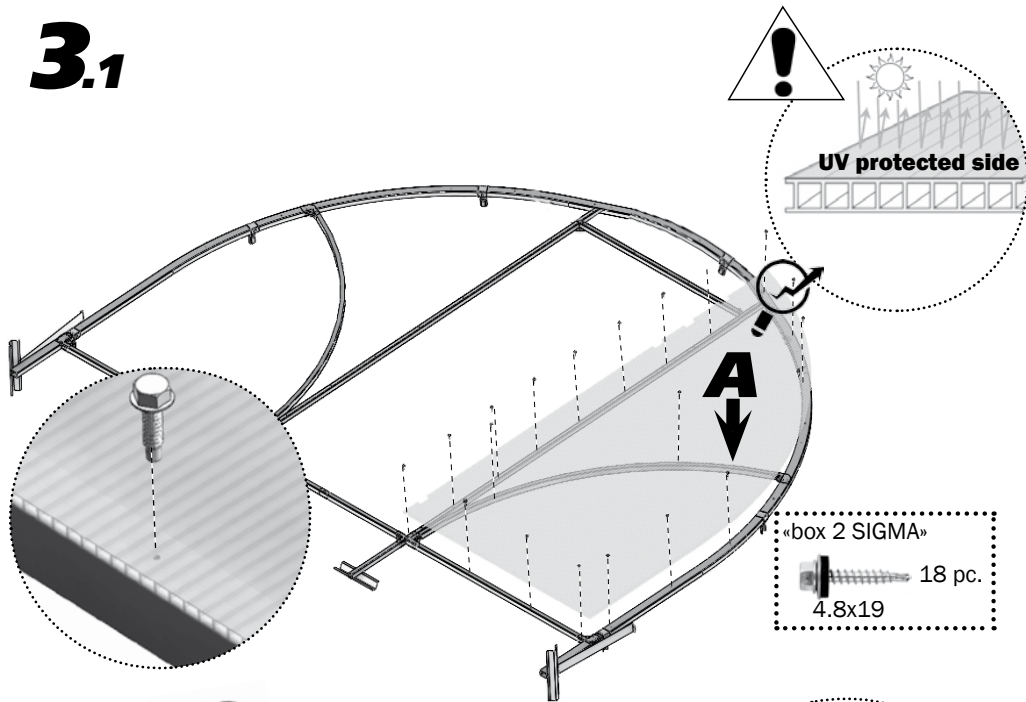

3.2

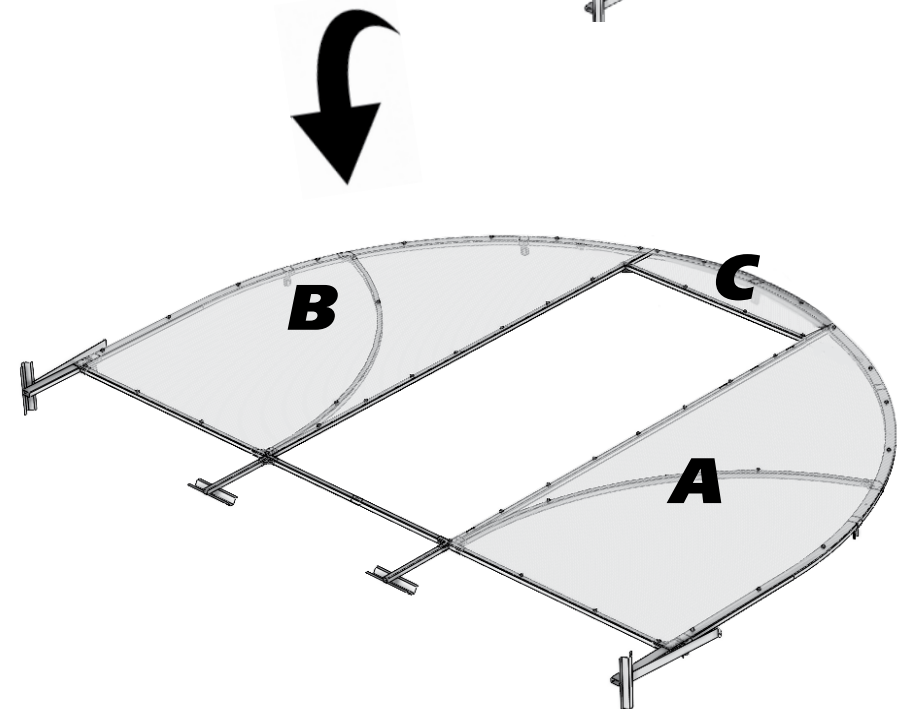
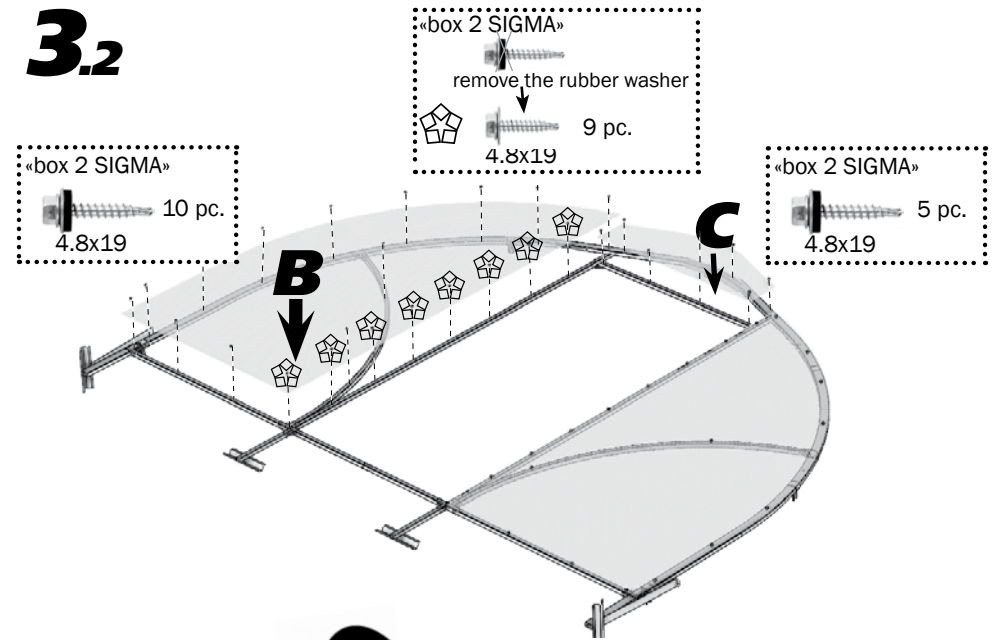

x2

4.1

№31 from «box 2 SIGMA» 4B 1 pc.	№32 from «box 2 SIGMA» 4H 2 pc.
---------------------------------------	---------------------------------------

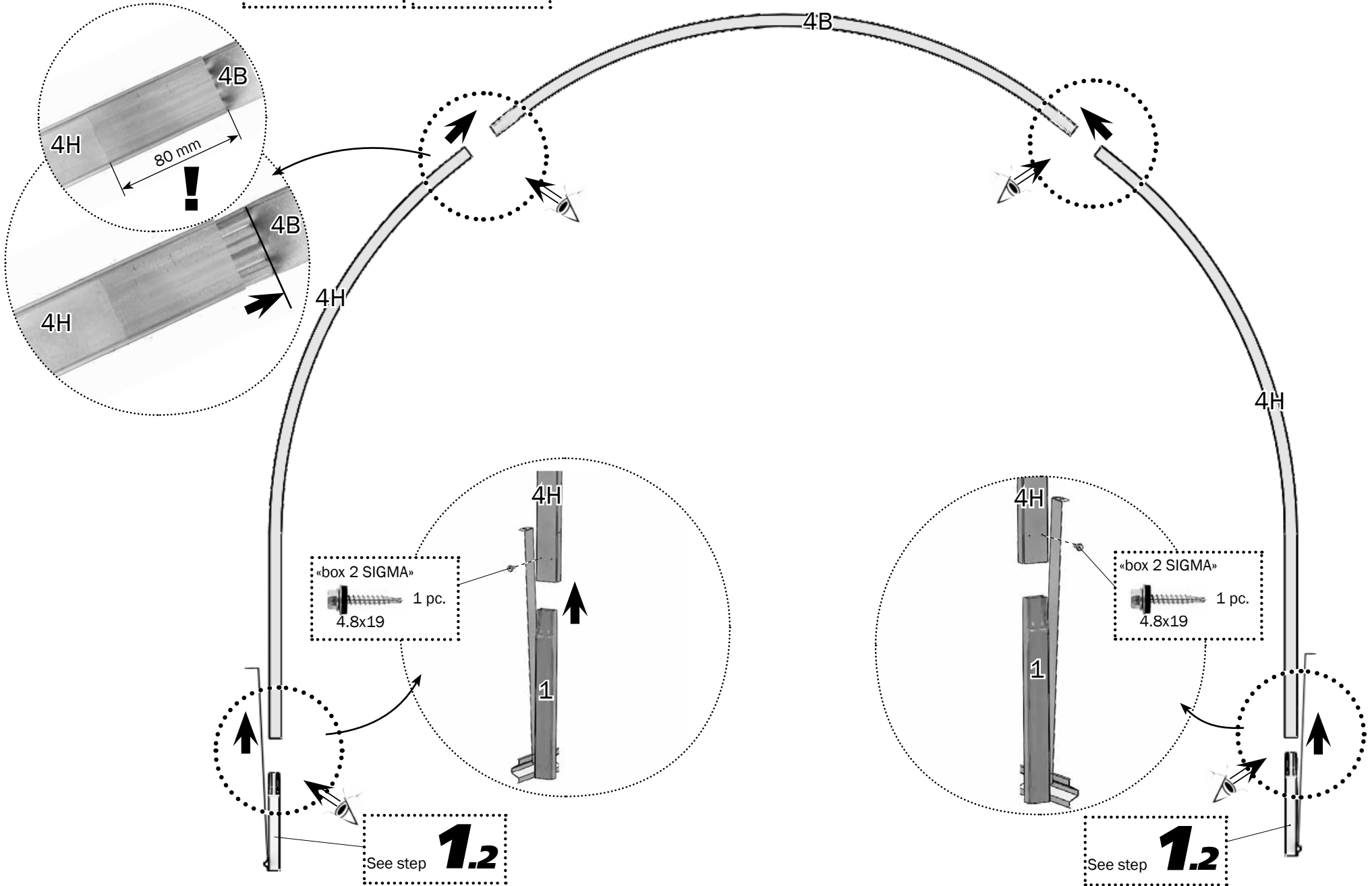

5.1

If the greenhouse is purchased with Roof Ventilation Window please refer to the Sigma Window Installation Manual to install the window hinges and extra perlin **2**

№3 from
«box 1 SIGMA»
7 pc.

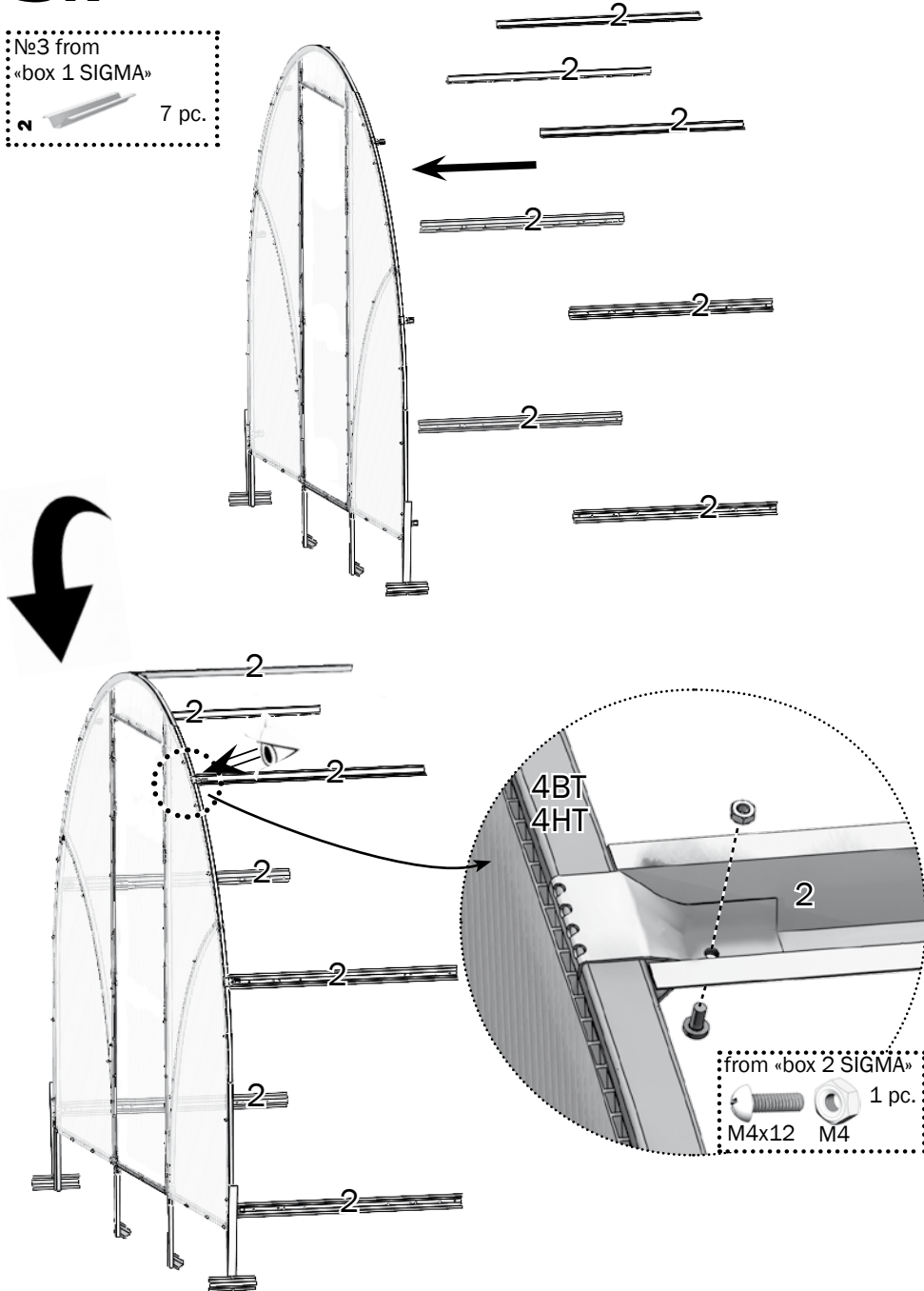

5.2

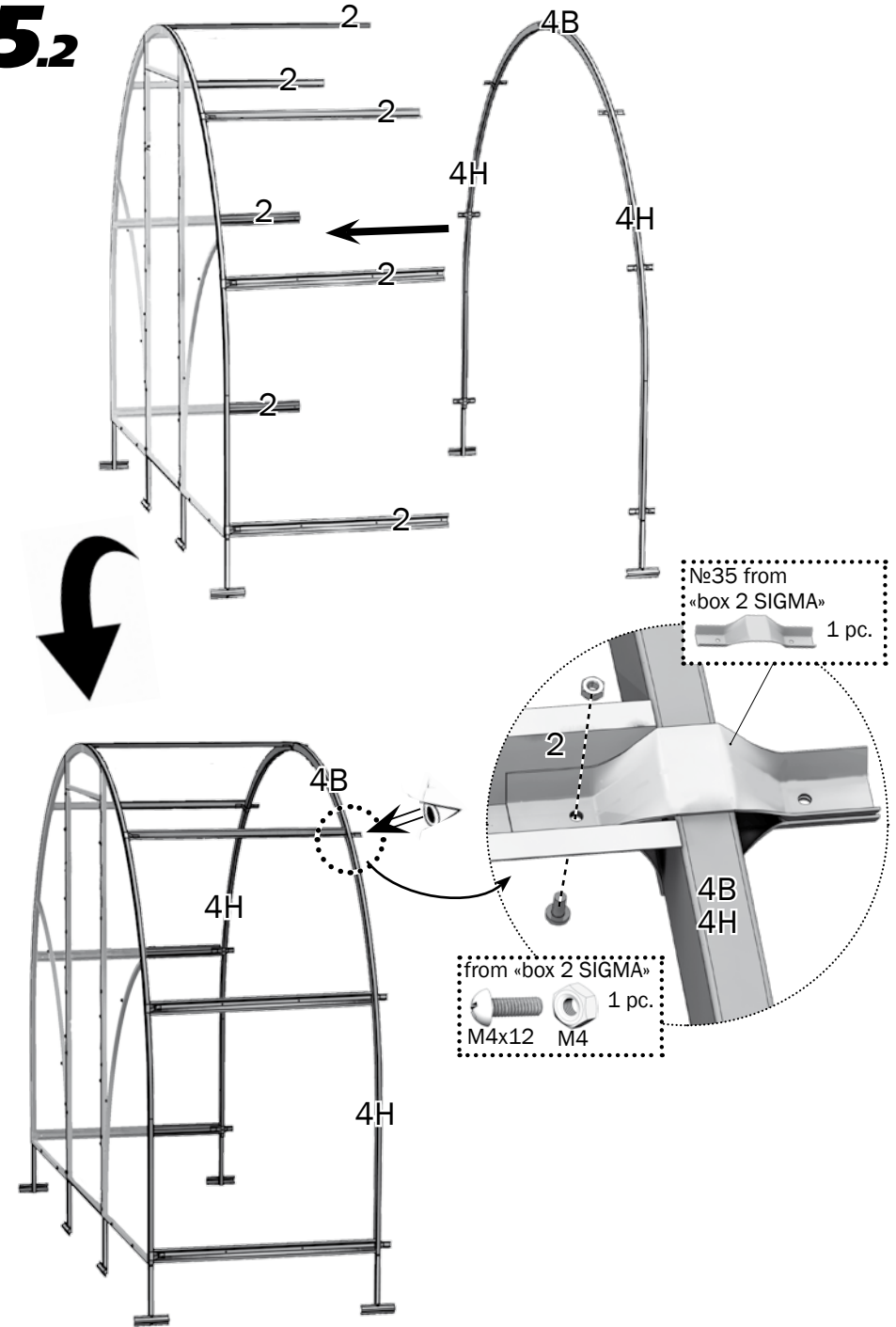

5.3

№3 from
«box 1 SIGMA»
2 7 pc.

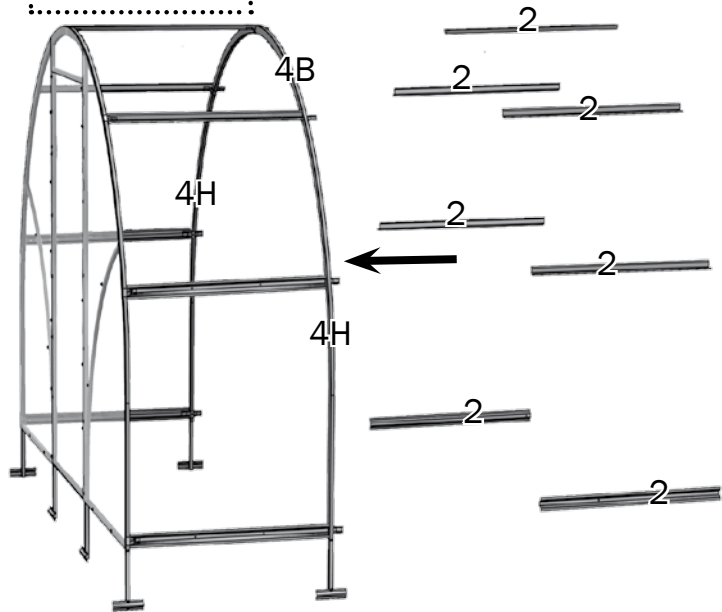

5.4

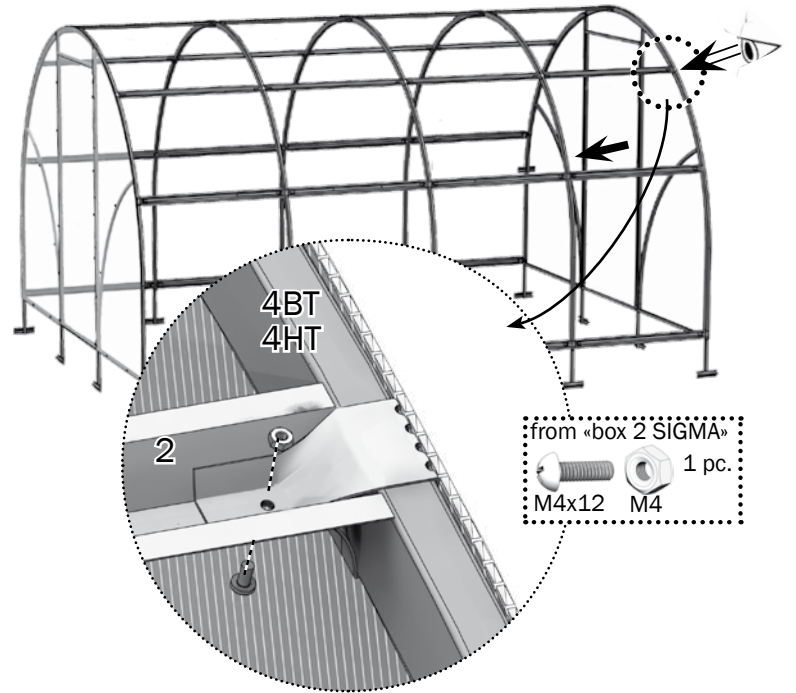

6

LENGTHENING OF THE BASE WITH THE INSERT

№2 from «box EXTENSION SIGMA» 4 pc.
 №4 from «box EXTENSION SIGMA» 14 pc.
 №1 from «box EXTENSION SIGMA» 2 pc.

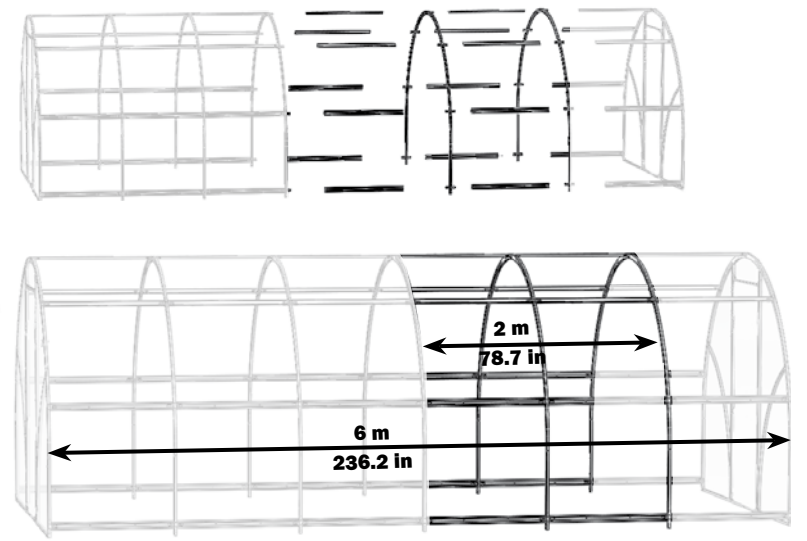
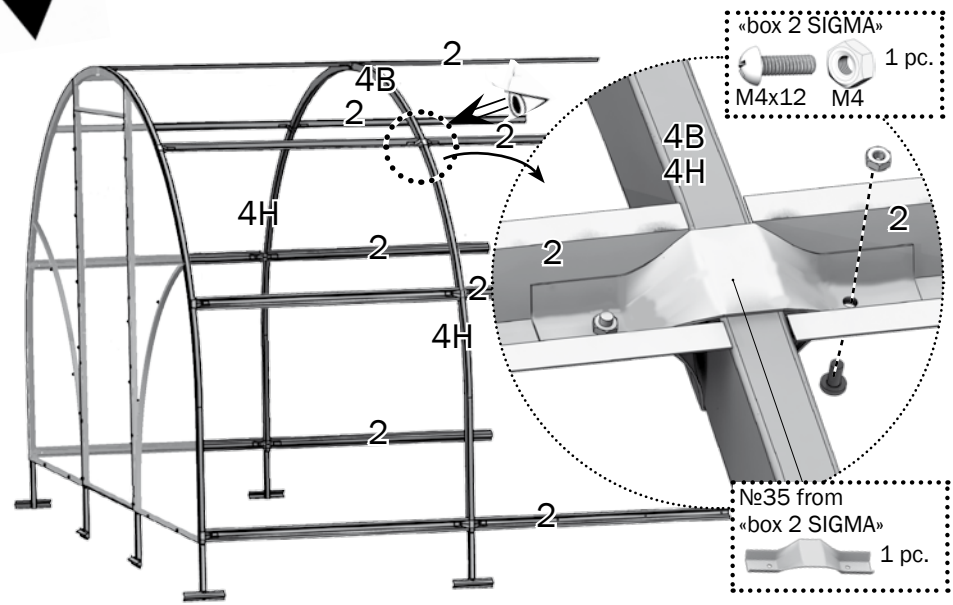

7.1

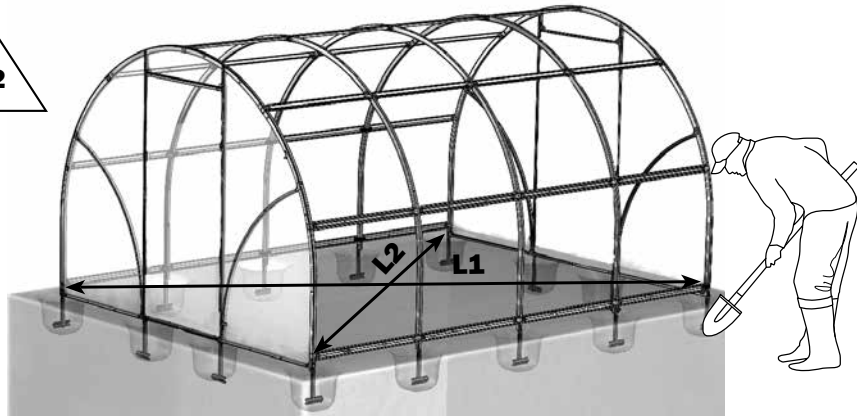

7.2





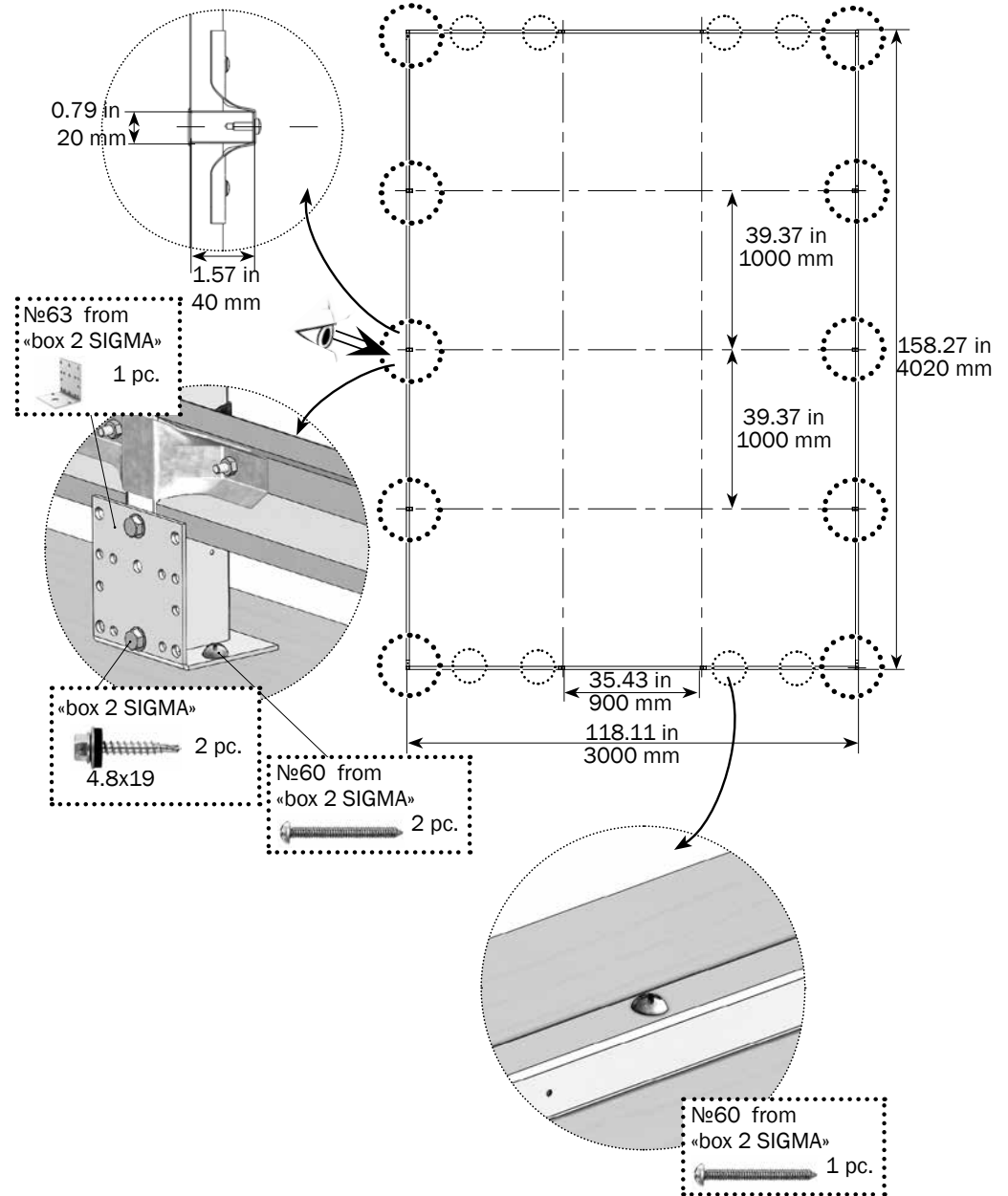
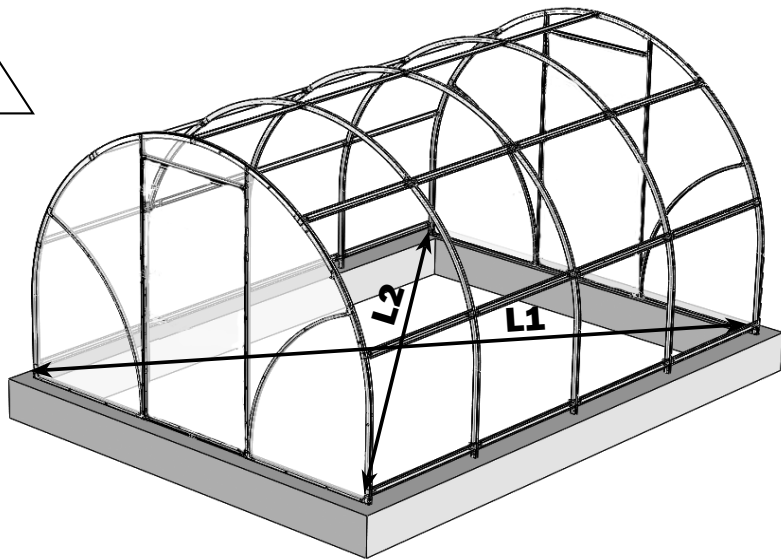

MOUNTING ON THE FOUNDATION



8.1

Inner side of the window.

Pre-Drilled pin holes are on the backside and will be facing the polycarbonate panels.

- | | | | |
|---|---|---|---|
| №11 from «box 1 SIGMA» | №12 from «box 1 SIGMA» | №13 from «box 1 SIGMA» | №15 from «box 1 SIGMA» |
|  1 pc. |  1 pc. |  1 pc. |  1 pc. |

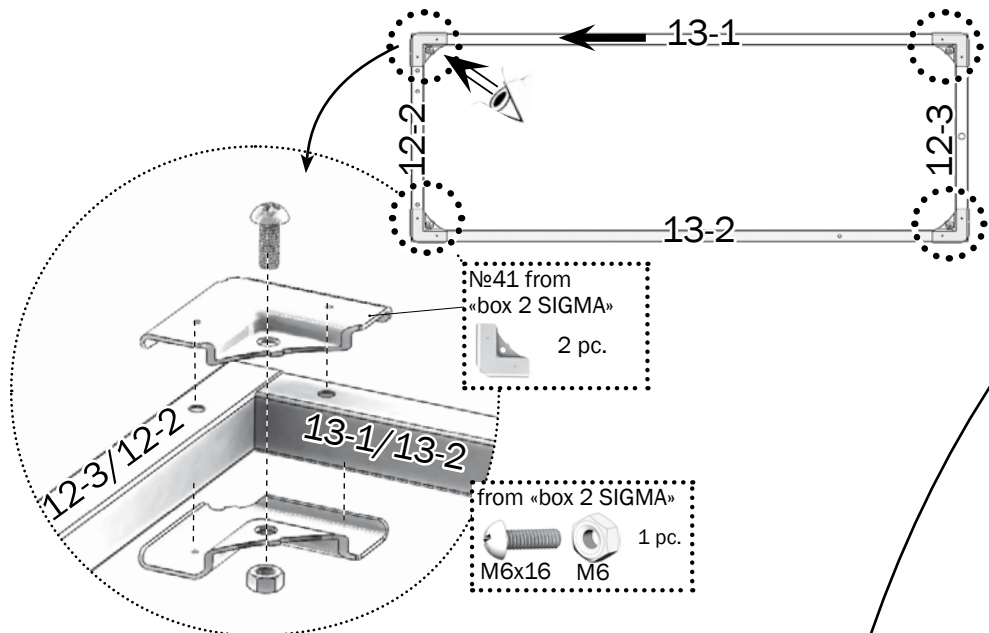

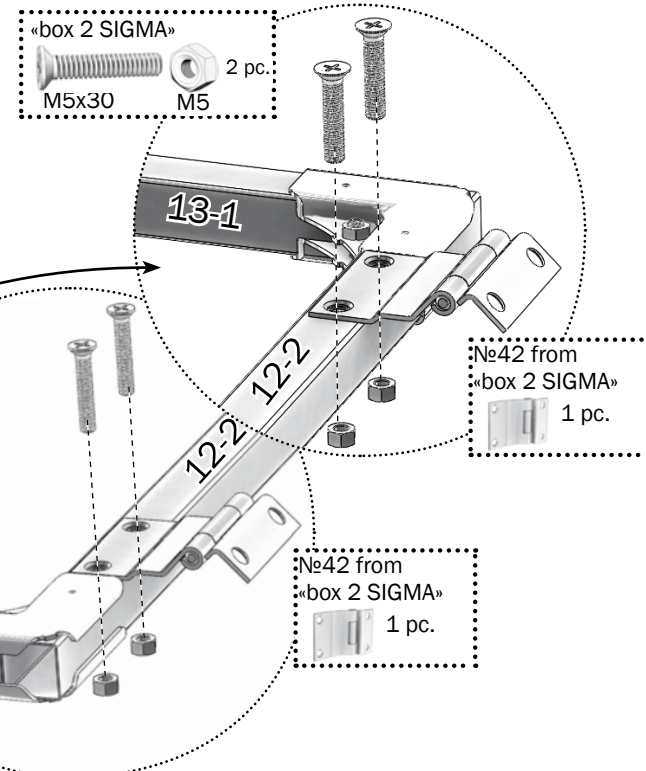
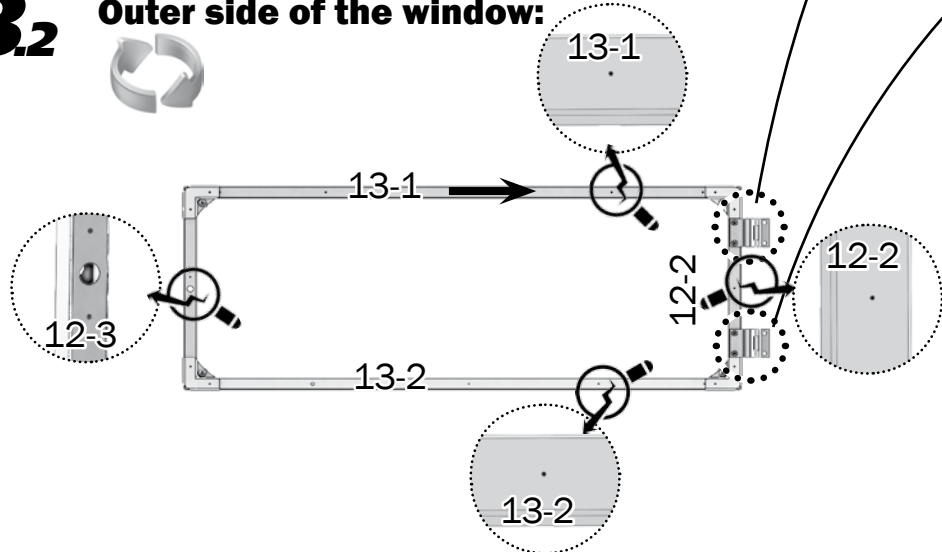

8.2

Outer side of the window:



8.3

- | | | |
|---|---|---|
| №22 from «box 1 SIGMA» | №23 from «box 1 SIGMA» | №24 from «box 1 SIGMA» |
|  1 pc. |  1 pc. |  2 pc. |

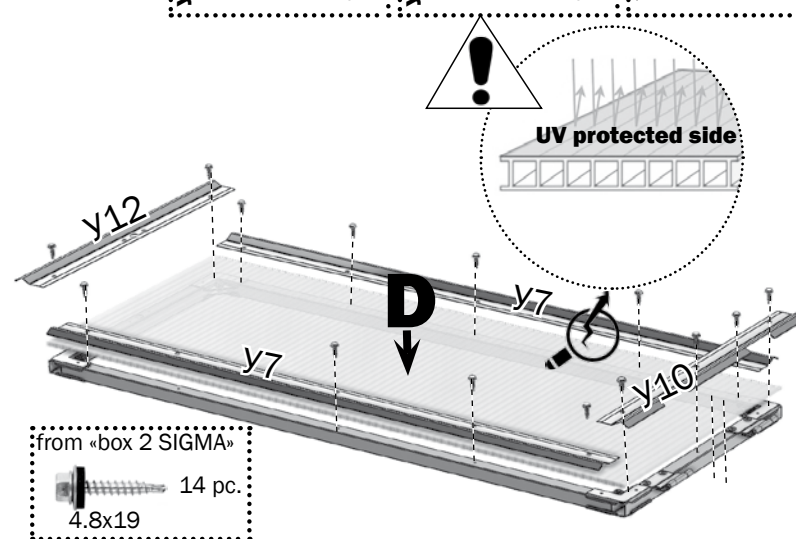

x2

9.1 Inner side of the door.



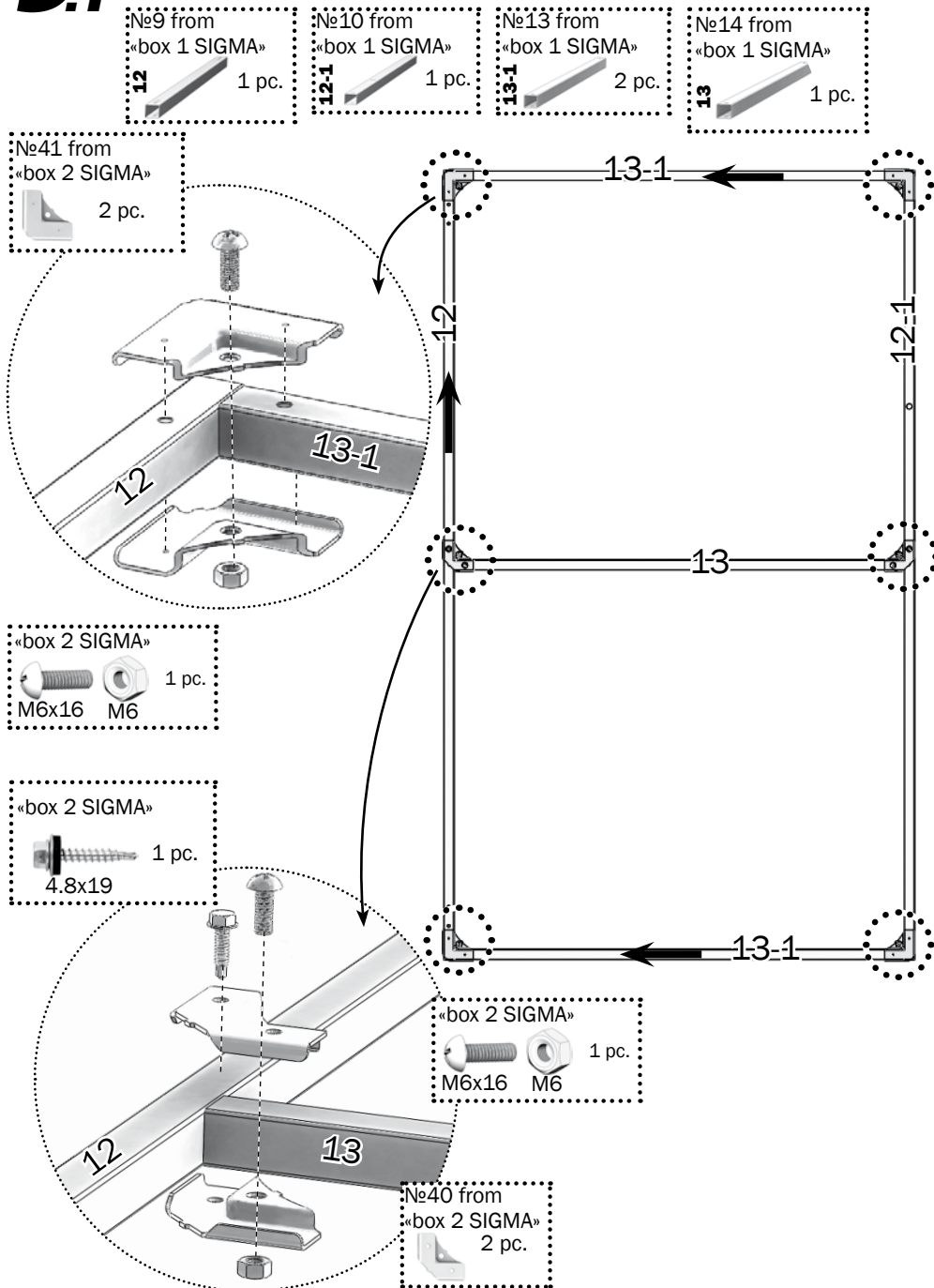

Pre-Drilled pin holes are on the backside and will be facing the polycarbonate panels.

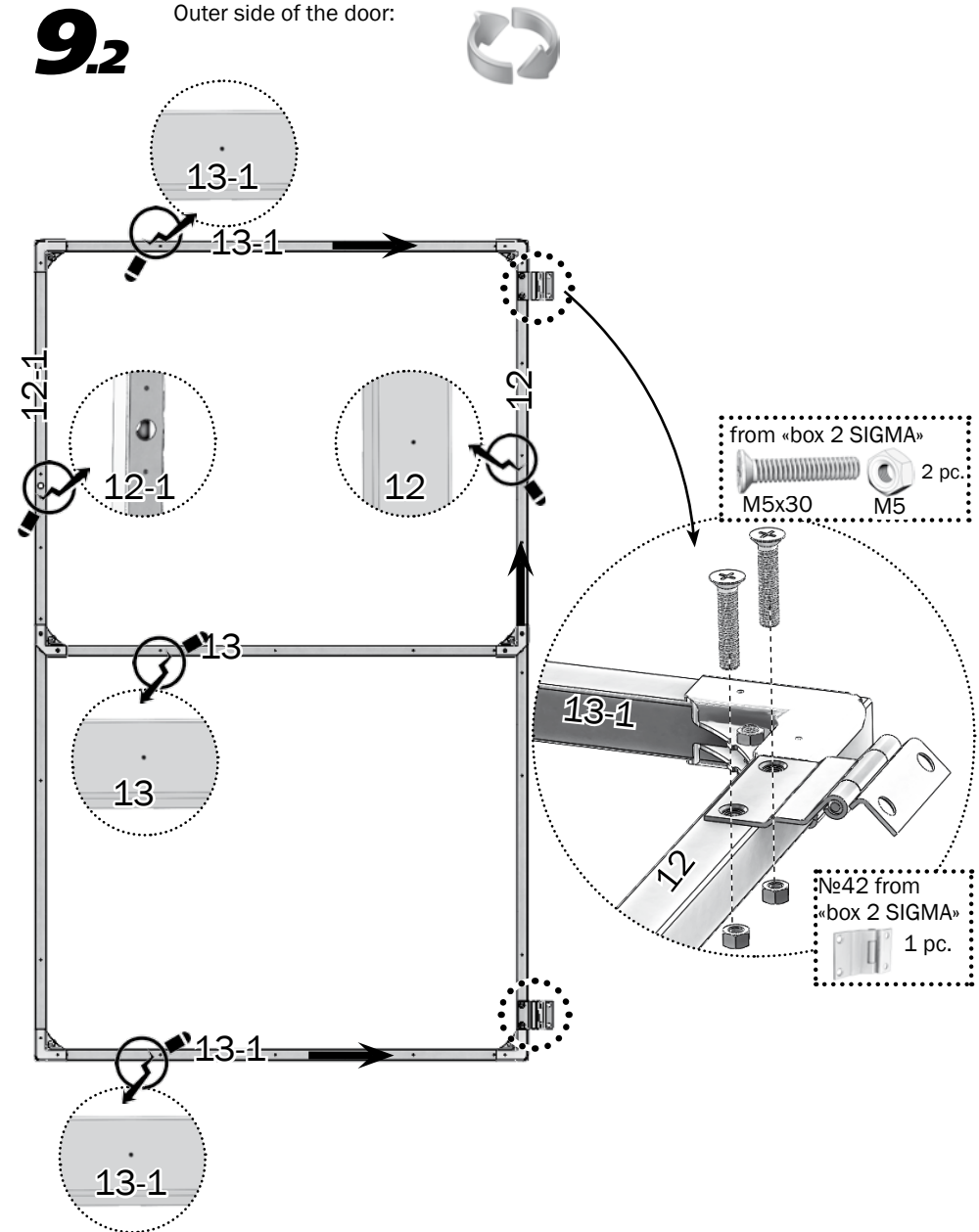

9.2 Outer side of the door:



9.3

№18 from «box 1 SIGMA»	№19 from «box 1 SIGMA»	№20 from «box 1 SIGMA»	№21 from «box 1 SIGMA»
 1 pc.	 1 pc.	 1 pc.	 1 pc.

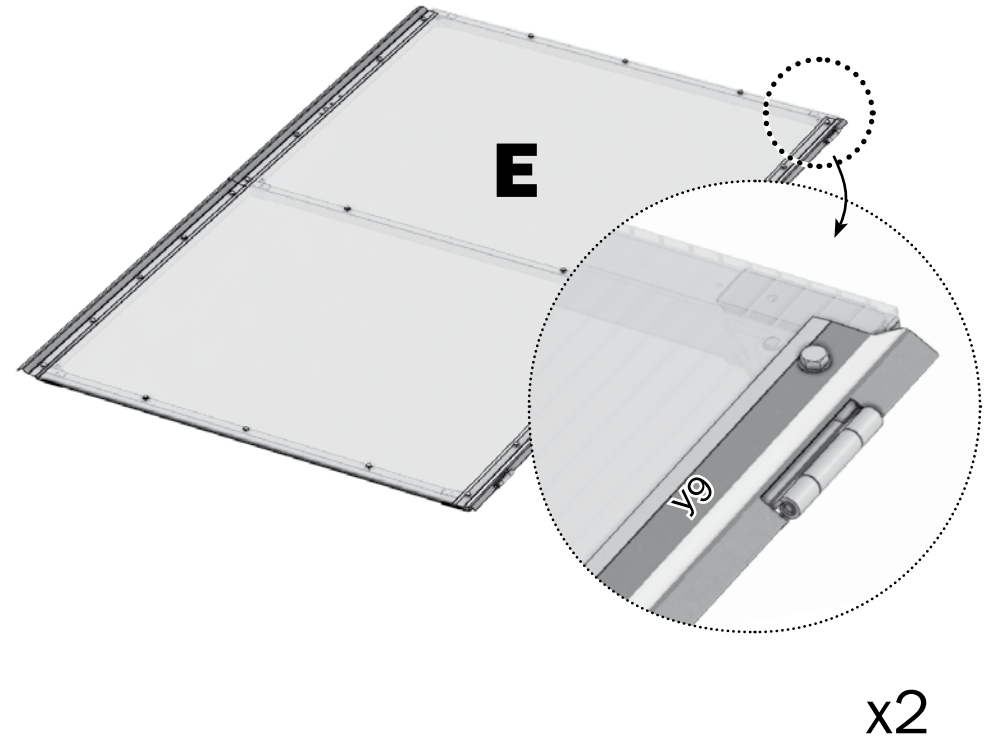
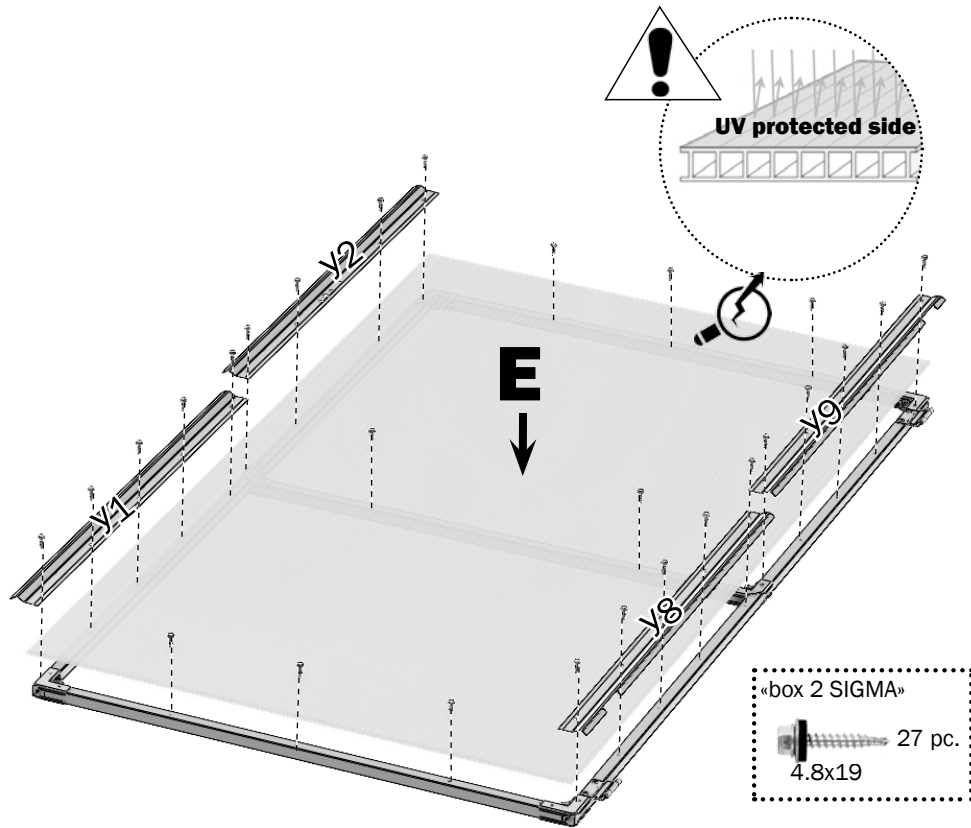

10

Outer side of the end wall: The door and the window are secured in «Opened» position.

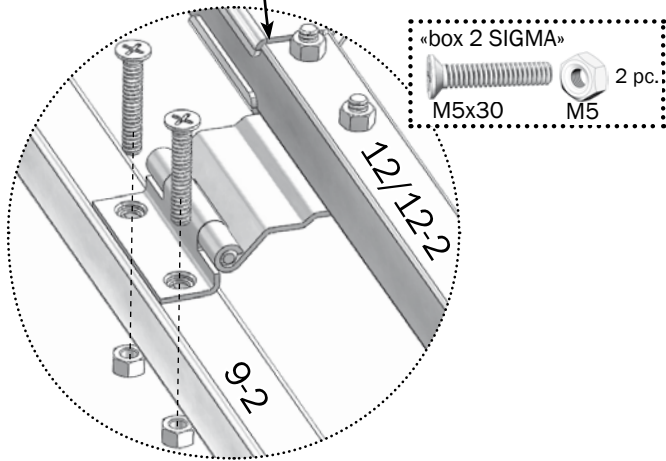
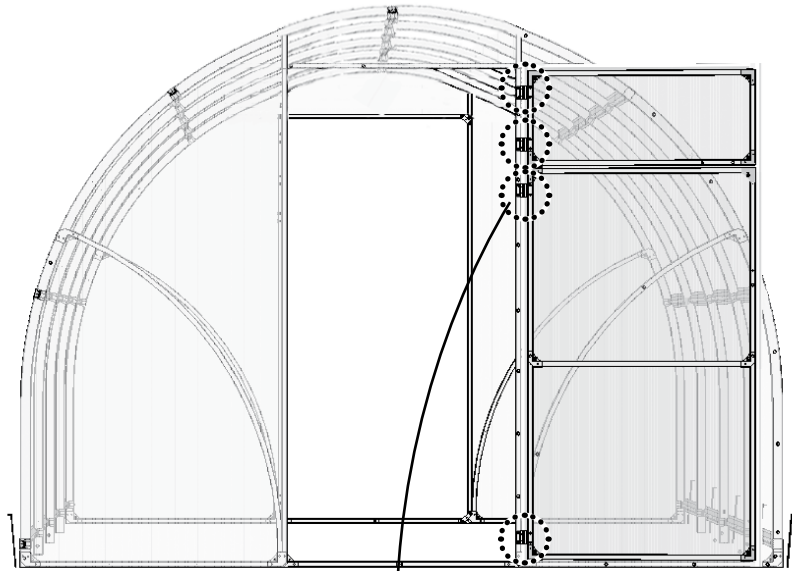

11

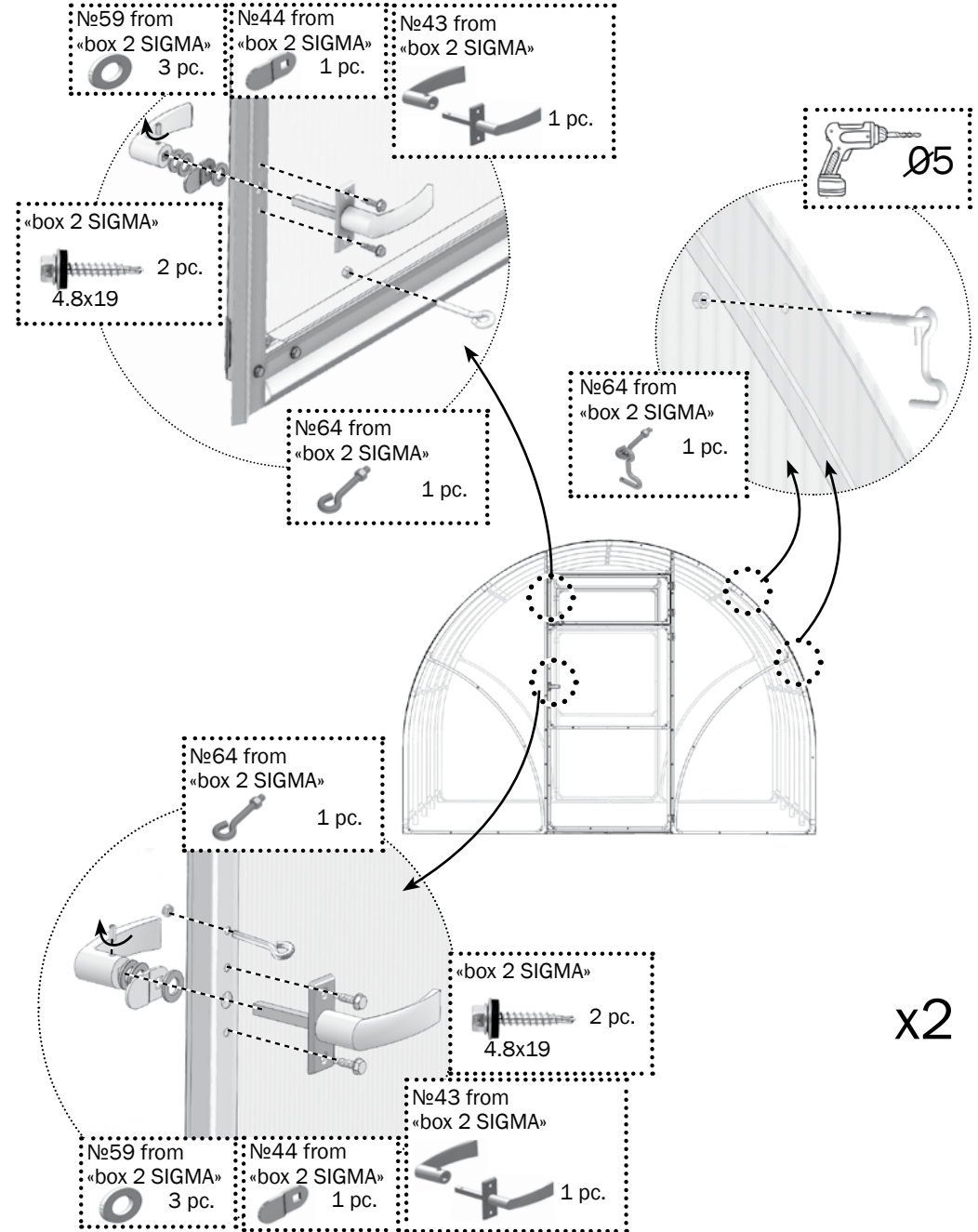

12.1

Cellular polycarbonate panels are installed with a certain surface, which has a protective layer, outside (towards the sun). The protective layer usually has a side with the inscriptions on the transportation film. The other side of the film is transparent. Mark the protective side of the sheet in each panel because after removing the transportation film, the sides of the panel do not visually differ. The transportation film should be removed from both surfaces before fixing the glazing on the frame.

It is necessary to stick the adhesive tape over the open polycarbonate shearing surfaces

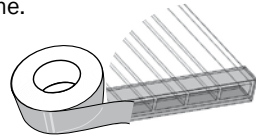

№16 from «box 1 SIGMA»
PK 2 pc.

№66 from «box 2 SIGMA»
2 pc x 1.05 m
41.3 in

№ 17 from «box 1 SIGMA»
P 2 pc.

№66 from «box 2 SIGMA»
2 pc x 1.05 m
41.3 in

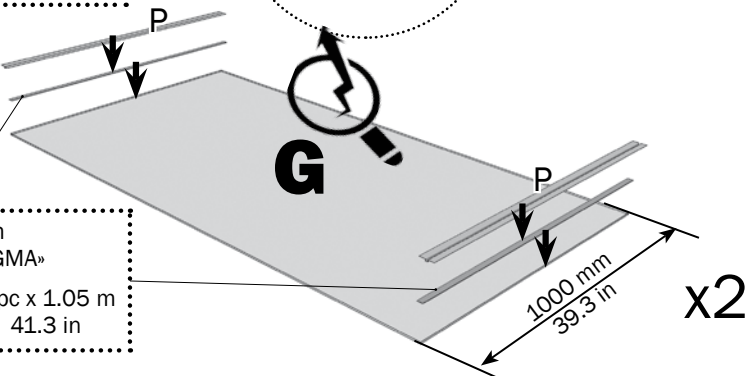
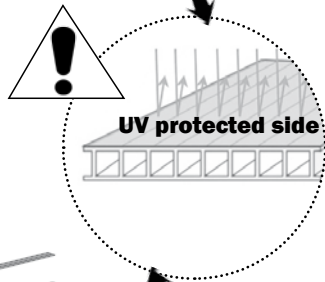
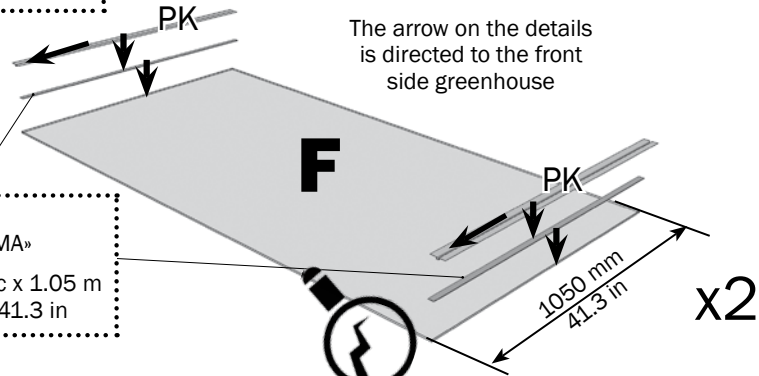

12.2

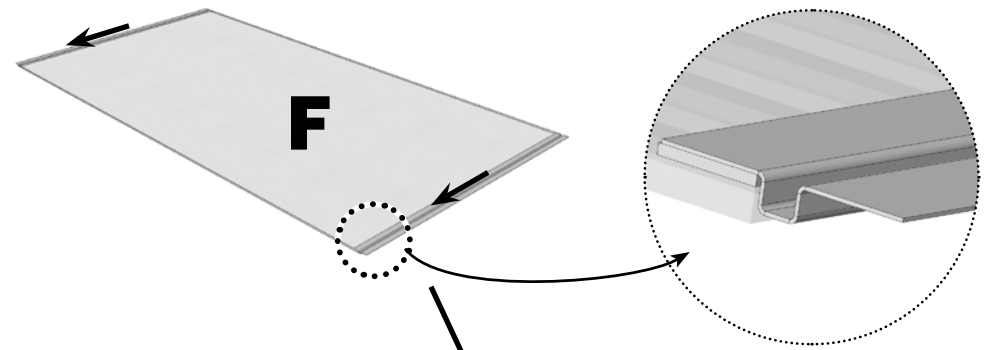

«box 2 SIGMA»
M4x35 M4 1 pc.

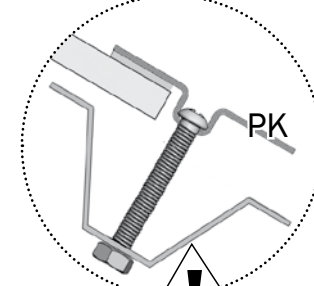
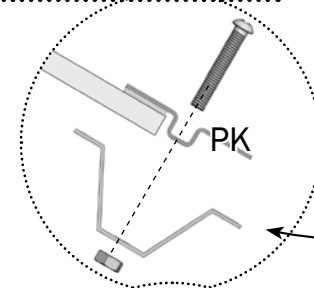

do not fully tighten!

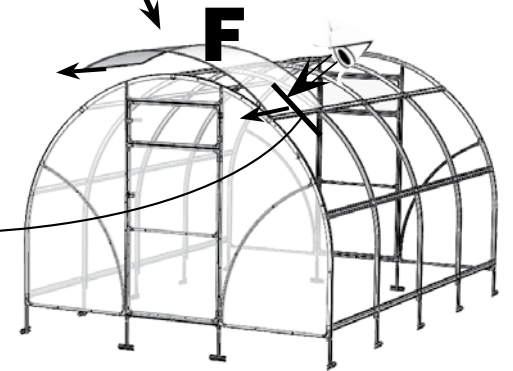

12.3

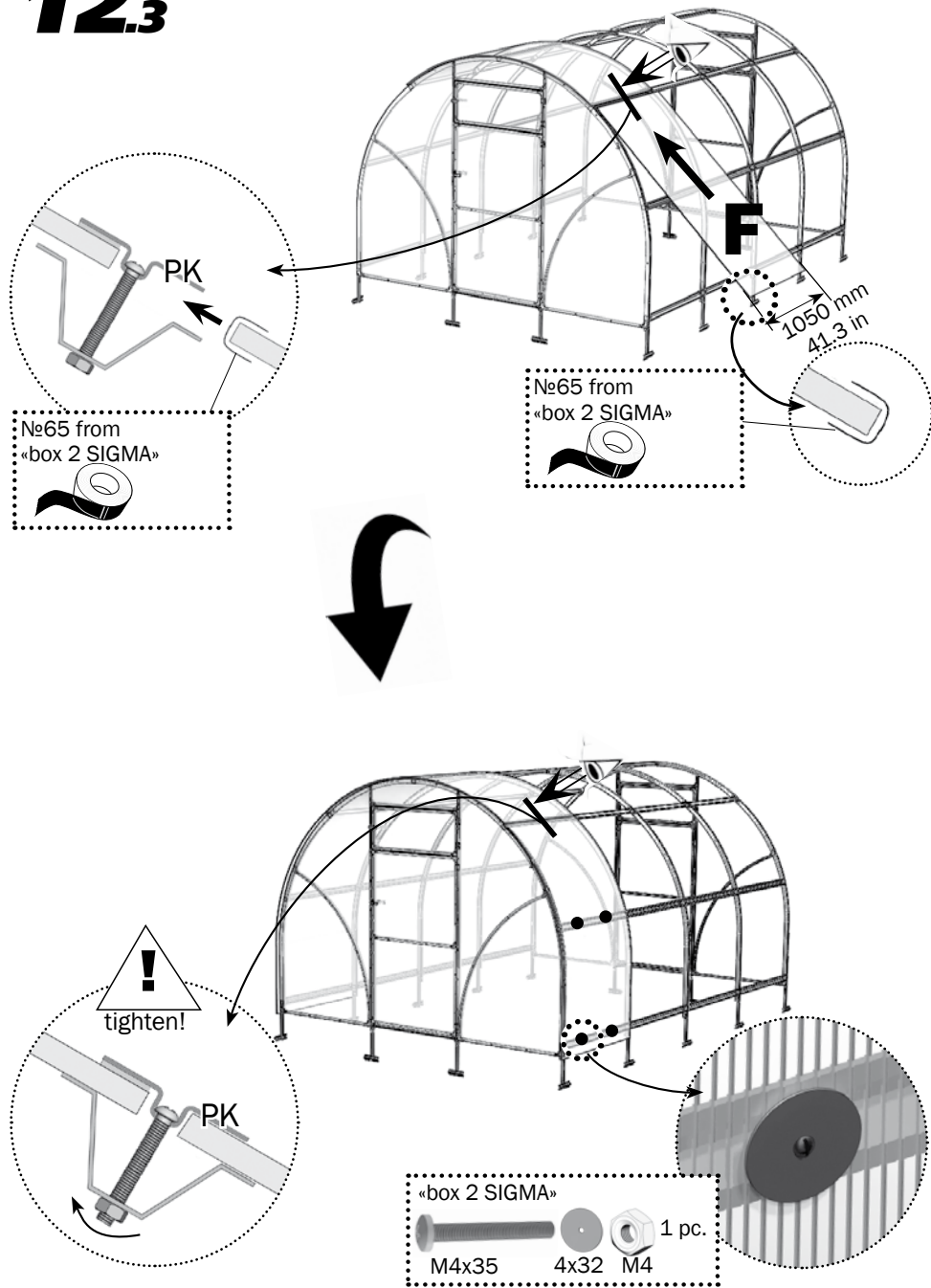

12.4

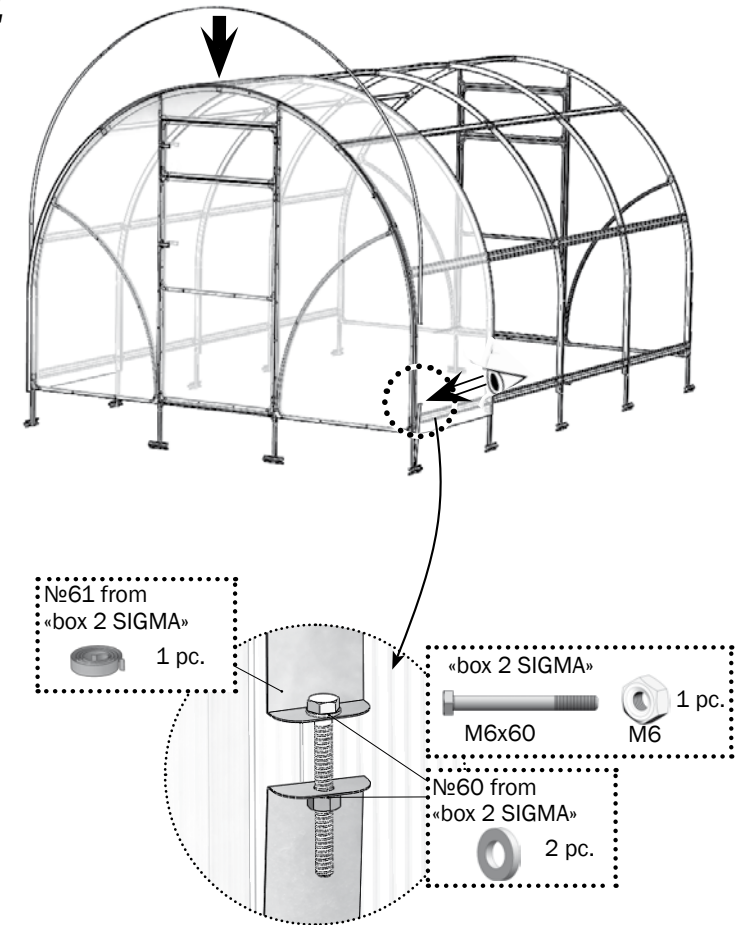

12.5

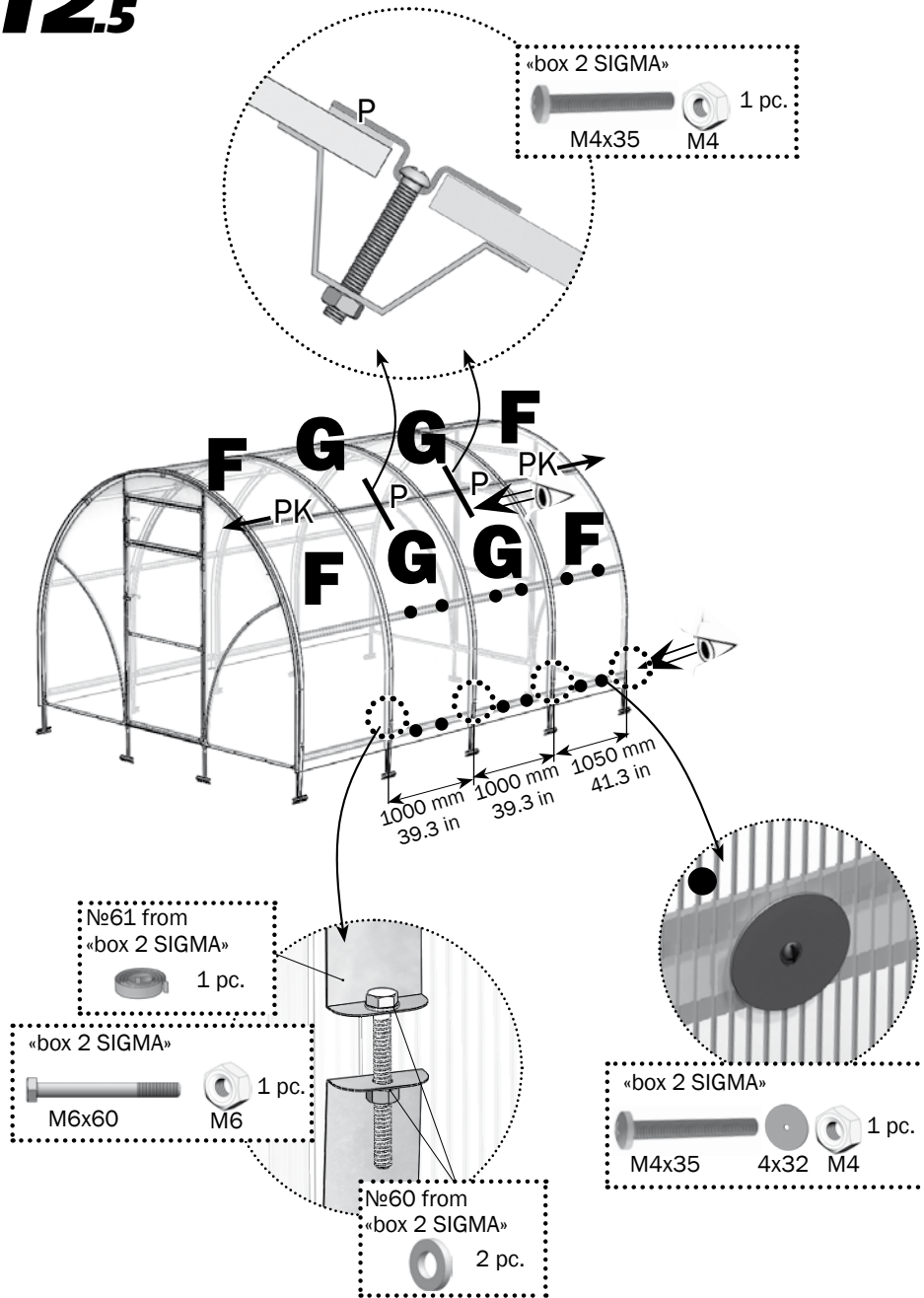

12.6

MOUNTING ON THE FOUNDATION

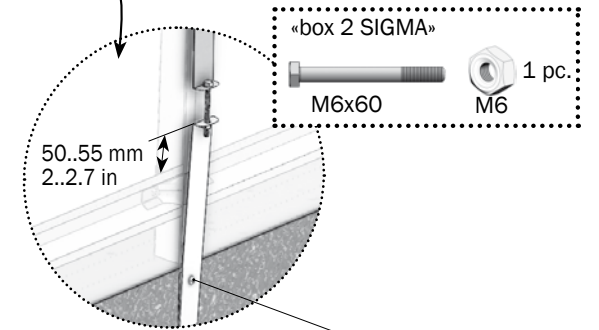
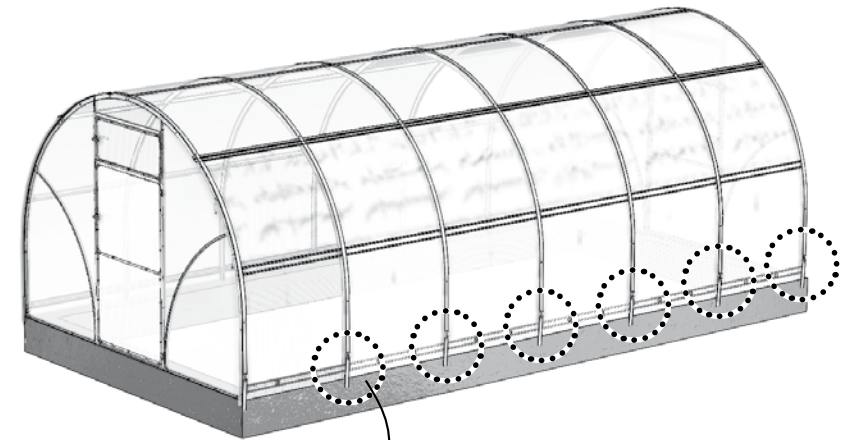

Fix the bottom metal fastening band to the foundation with appropriate fasteners at the specified distance, in the case of installation on the foundation.

13.1

This is Optional to provide support for the roof load.

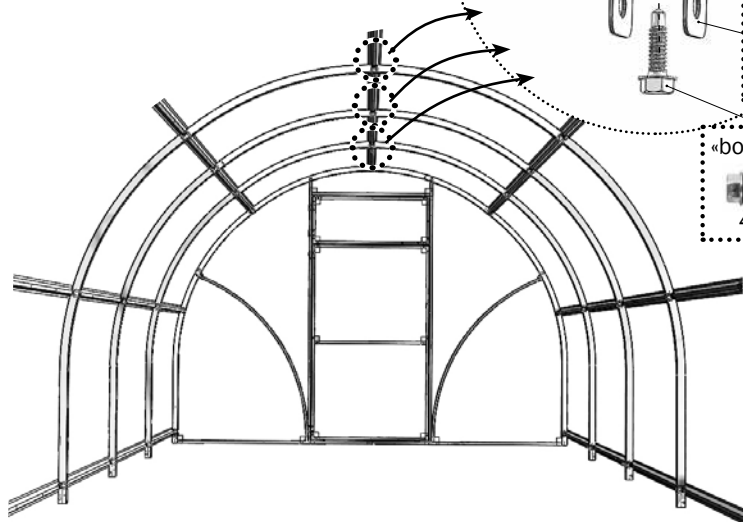
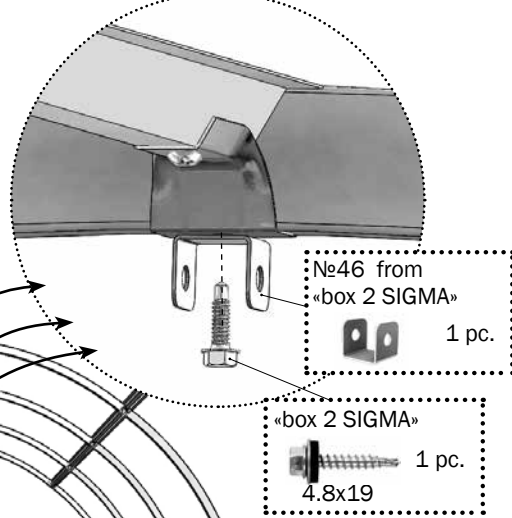
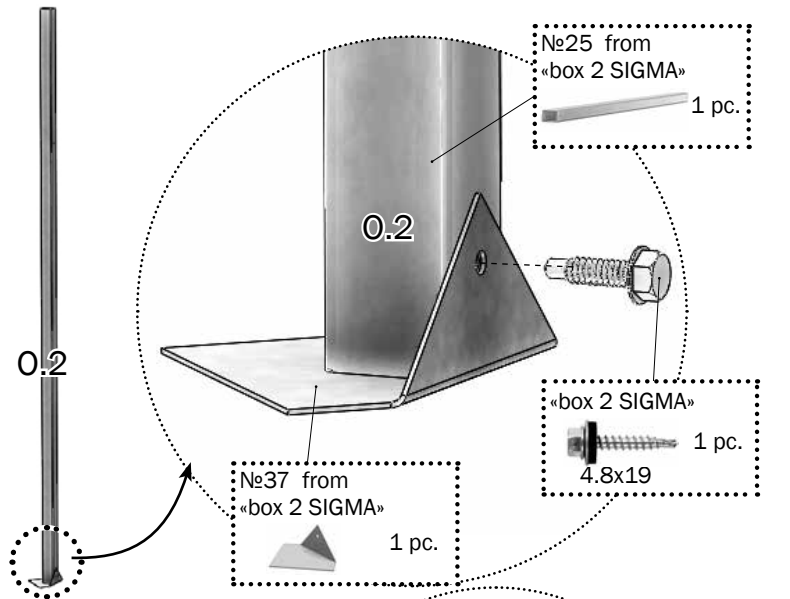

13.2

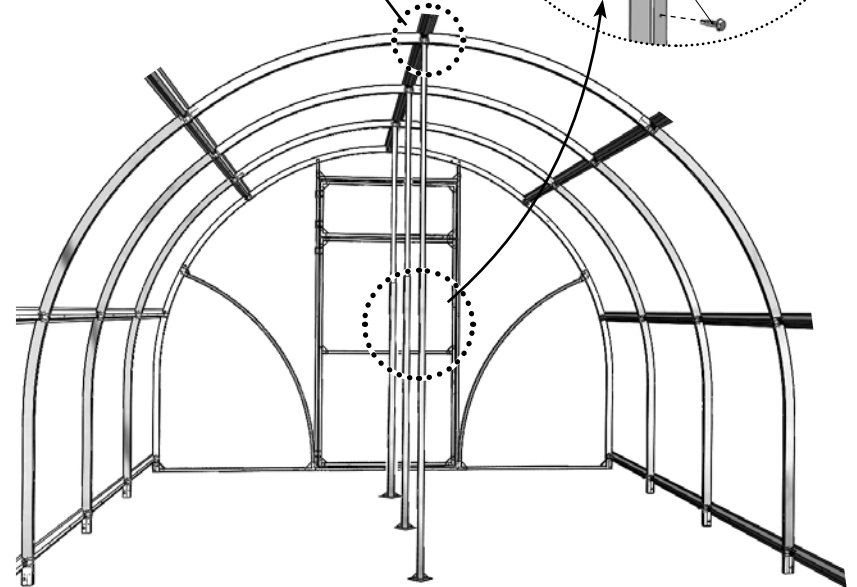
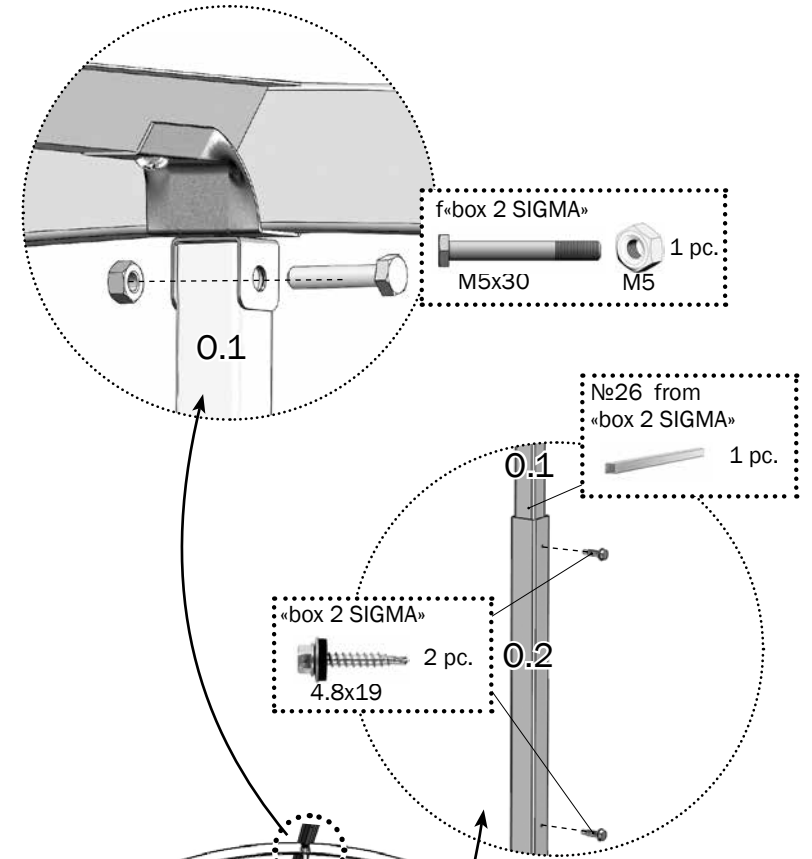



Imported by Planta Greenhouses
telephone: 1(877) 669-1286
e-mail: info@plantagreenhouses.com

This manual cannot be reproduced in any form, fully or partially,
without written consent of Planta Greenhouses