



www.divetogarden.com

832-363-8000



ALUMINIUM Greenhouse

Riga S / Riga

Technical changes reserved.

Mounting instruction *Basic kit*

As at 02/2005

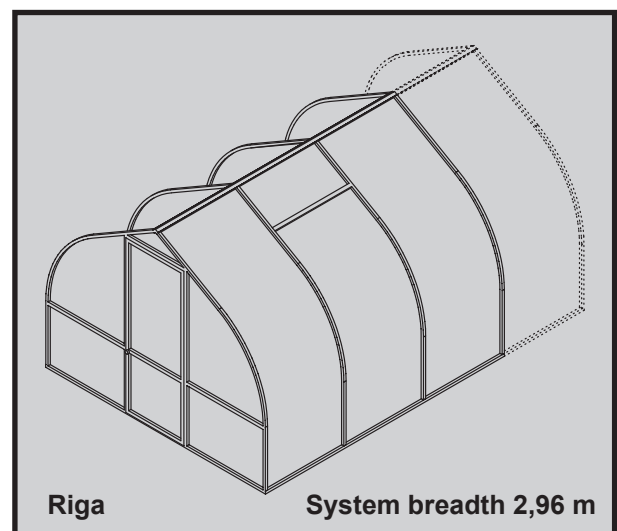
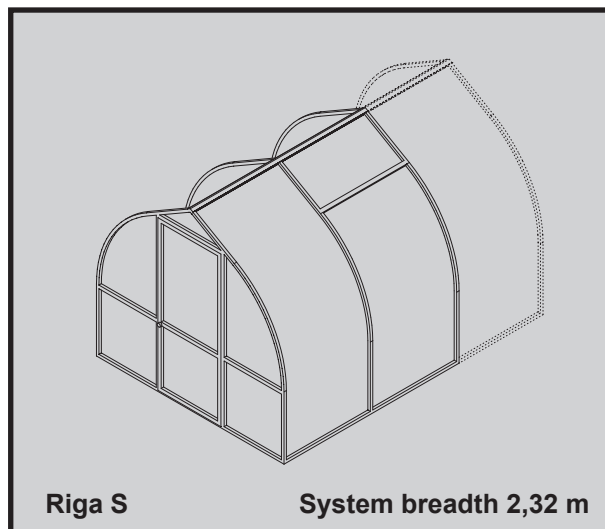

Dear garden friend,

Congratulations for the purchase of an aluminum greenhouse from Hoklartherm.

The erection is simple. First read the mounting instruction and follow this step by step.

Parts and piece list

Start with the basic kit (please do not open all the boxes at the same time) and do not confuse about the numerous single parts.

Before you start with the assembly please check with the piece list, if all the parts are there. Every box is checked by a quality control before closing it and consequently missing parts can nearly be excluded. Should there be any lacking parts, please state the mistake in position.

Location

Please choose, as far as possible, a sunny place for your greenhouse. Avoid the shadow of buildings and trees. For vegetables like tomatoes, cucumbers and melons you have to place your greenhouse in the Northern-Southern direction. For flowers and pot plants it is the Eastern-Western direction.

Attention:

If possible, the greenhouse should be set up at a wind-protected place and not in stormy weather. It is dangerous to have stand a partly assembled house.

An assembly according to the rules lets resist this greenhouse heavy wind. The manufacture is not responsible for any damages being arisen by improper assembly or acts of God!

The assembly must be executed by at least two persons!

Work with safe, proper tools and be careful for a secure standing of the ladder during the assembly (danger of accident).

Do only work with gloves (danger of injury, danger of cutting)!

For the assembly you need the following tools:

- 1 pc screwdriver for recessed-head screws, size 2
- 1 pc open-jawed wrench 10 mm
- 1 pc screwdriver for slotted screws
- 1 pc Allan key 3 mm (in the bag of accessories for skylight)
- 1 pc water level
- 1 pc ladder
- 1 pc file to remove possible burs at the profiles
- 1 pc rubber hammer
- 1 pc measuring tape

assembly course gable
(see also description from p.14 on)
(View from the outside)

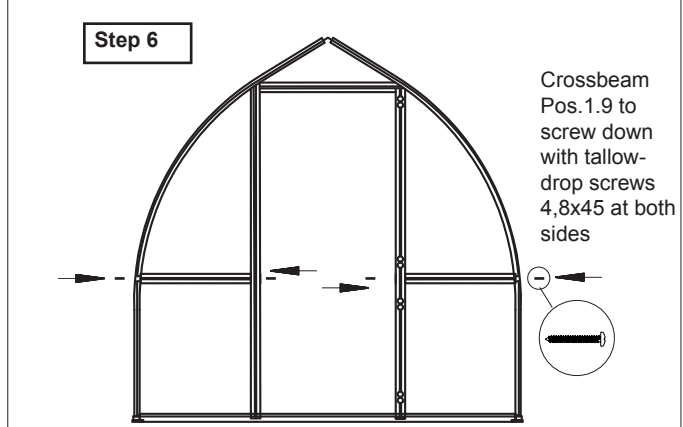
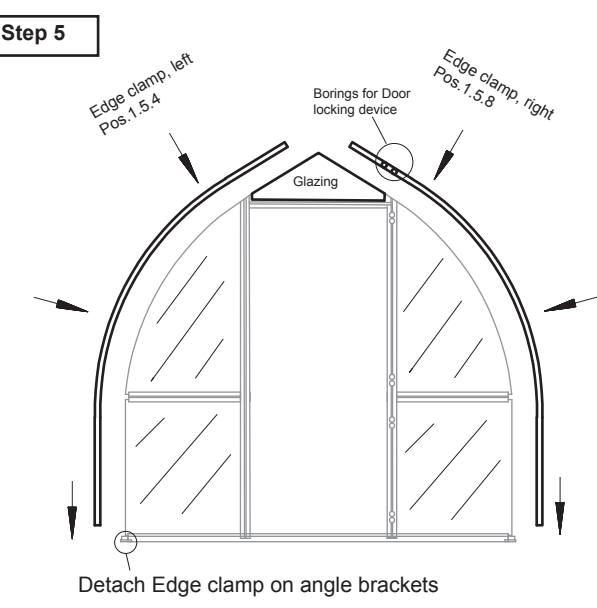
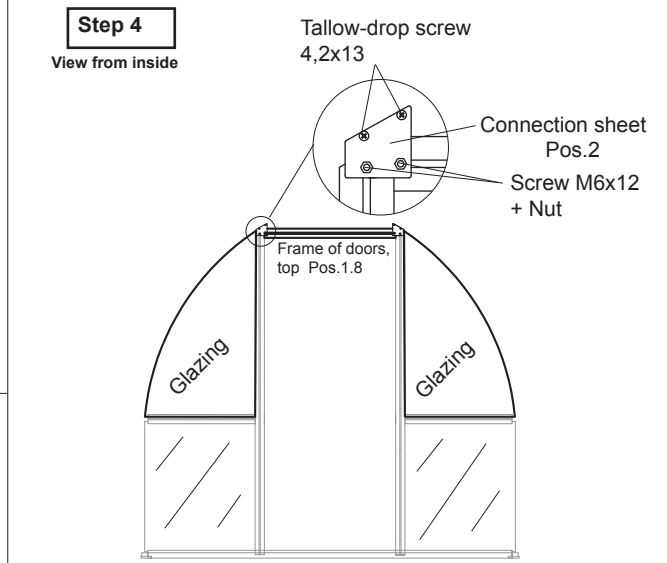
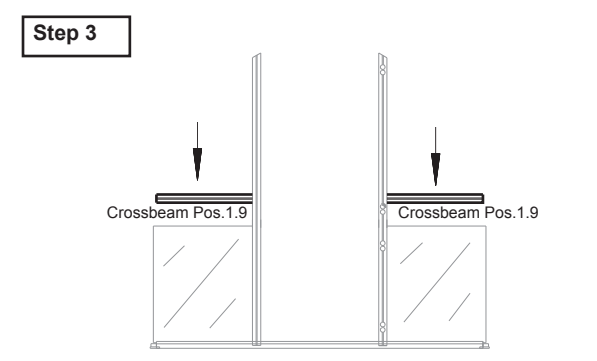
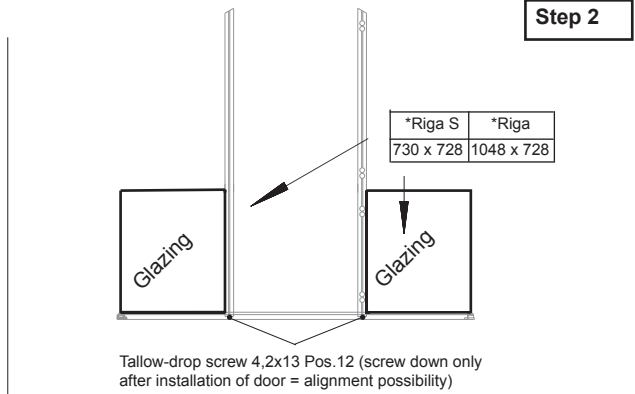
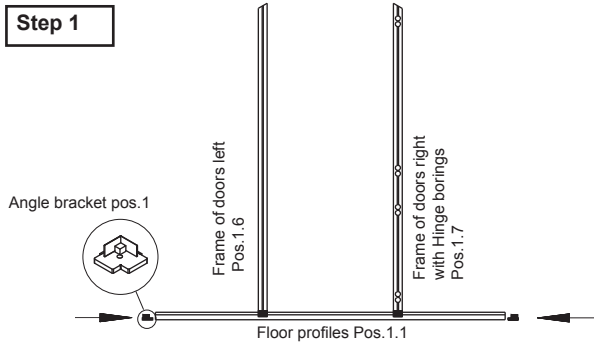

Step 7 only back wall gable! (View from inside)

Connect crossbeam with connection sheets and inserted screws M6x12 and nuts M12.*

Screws M6 can also be inserted later with every profile with PVC-gliders.

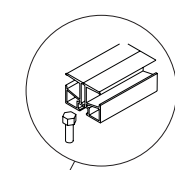
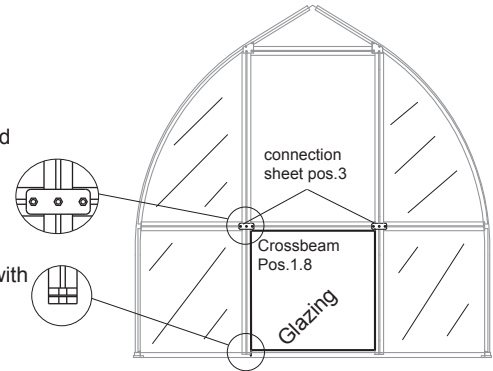

***Attention!** Introduce necessary screws M6x12 in profile nut before assembly (at Pos.1.8 and 1.9)

Assembly course eaves and roof

Step 8

for ex. back wall gable

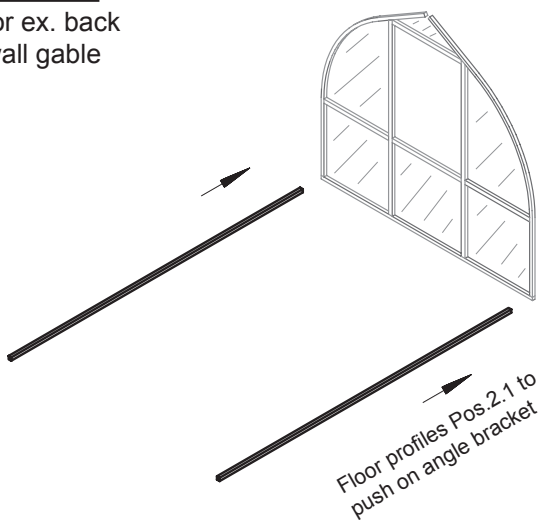

Step 9

Screw down ridge at gable with end plate Pos.4 (raised counter-sunk head screw 4,2x13)
Front gable to assemble the same way later!

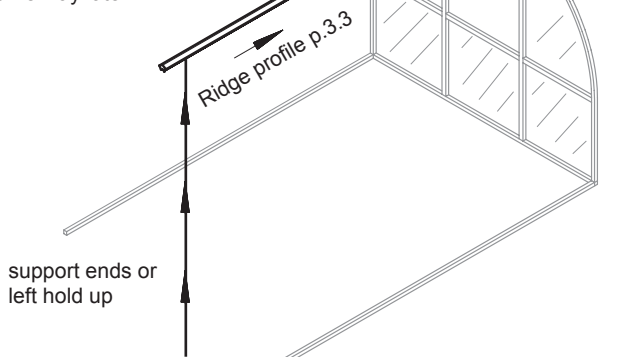

Step 10

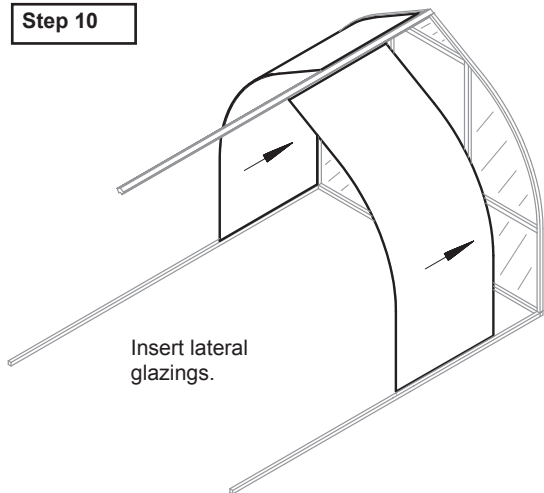

Step 11

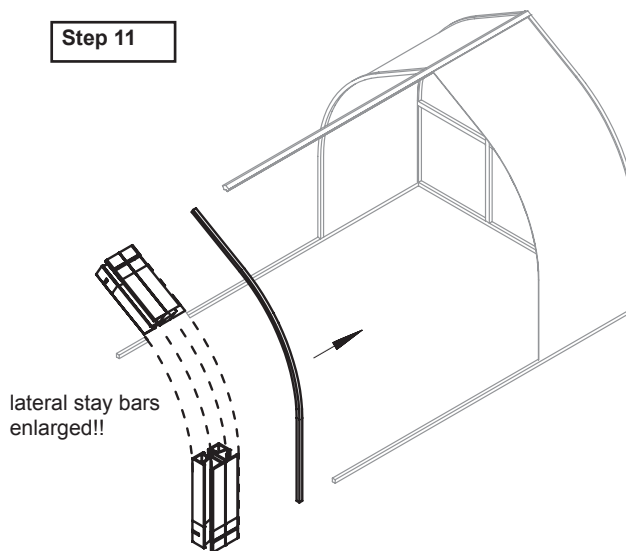

Insert lateral stay bars pos.2.3.1 top into ridge profile and below into floor profile. Push straight on up to glazing and "thread" pane.

Step 12

screw down round connection sheet pos.5 from inside with screw M6x12+nuts.

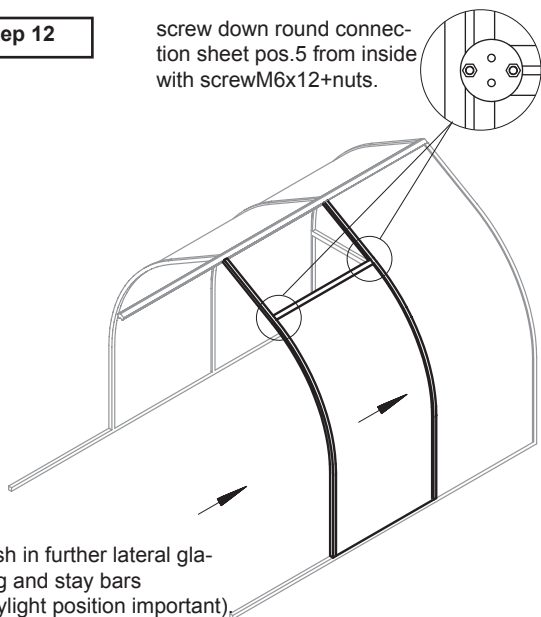

Step 13

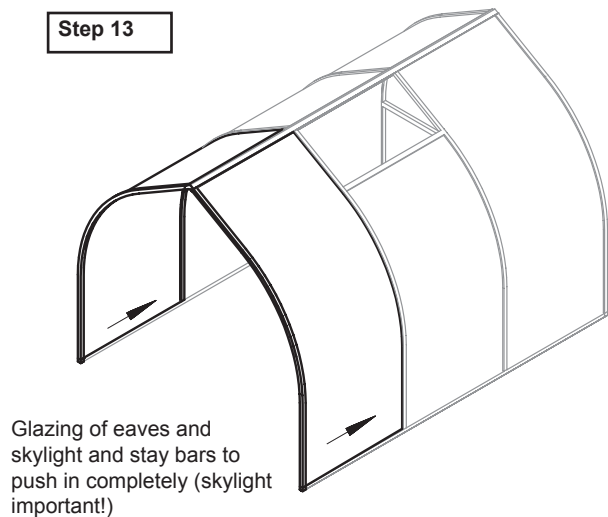

Step 14

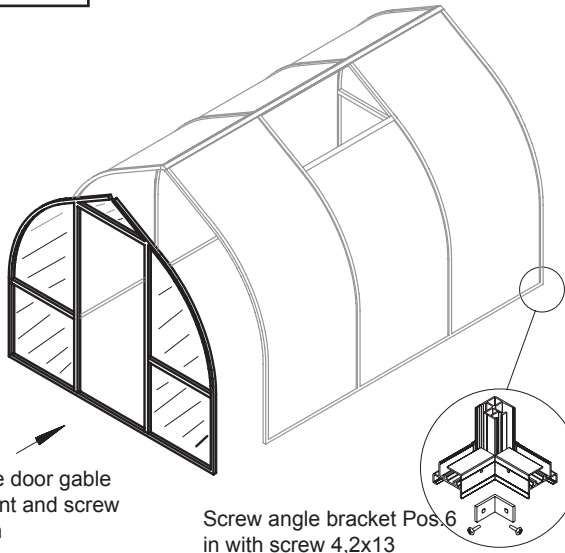

Place door gable in front and screw down

Screw angle bracket Pos.6 in with screw 4,2x13

Step 15

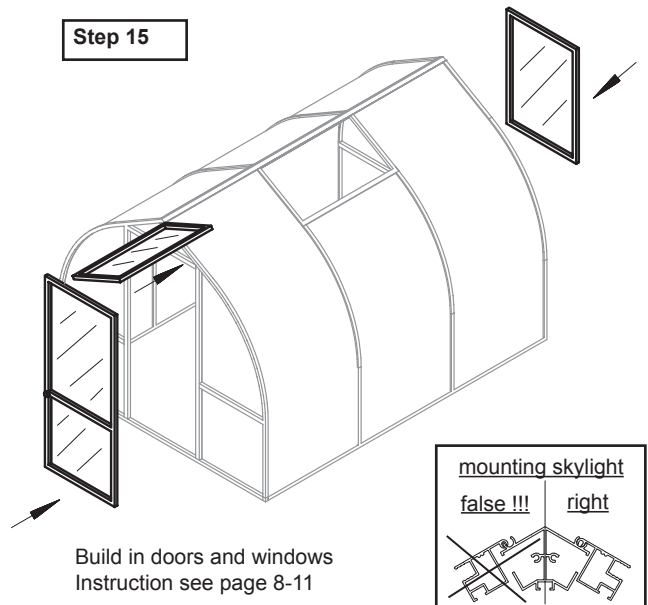

Build in doors and windows
Instruction see page 8-11

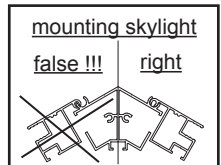

Step 16

for a better detail the panes are shown being cut.

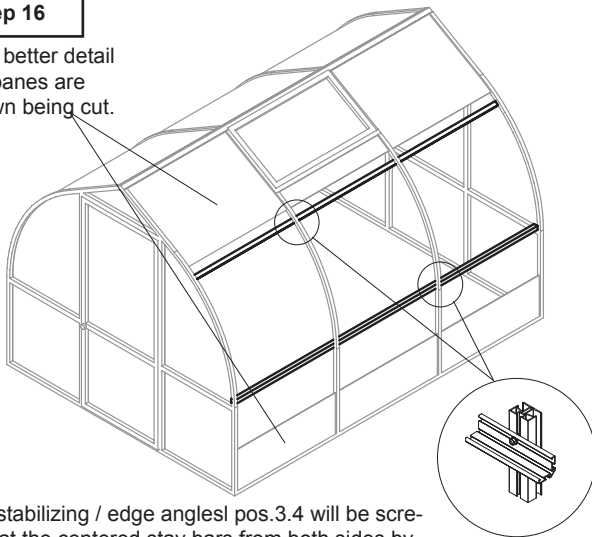

The stabilizing / edge angles pos.3.4 will be screwed at the centered stay bars from both sides by means of screw M6, nut and plain washer.
The angles are also back side profiles for tables and shelves (see separate mounting instruction)

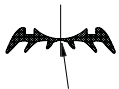
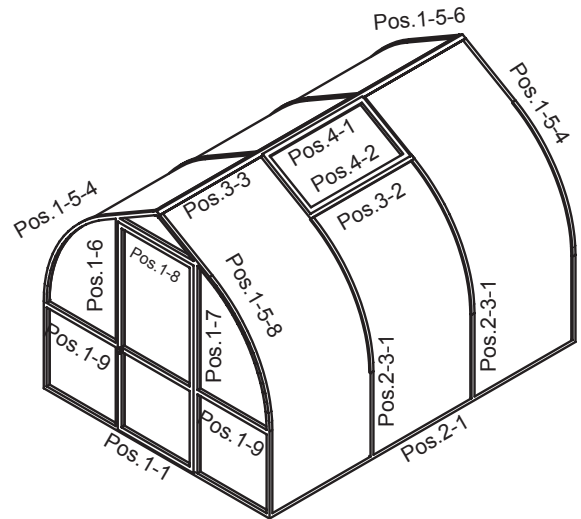

Pull apart wedge sealing Pos.11 in center!

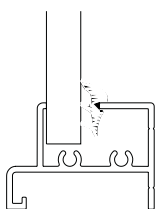

Press sealing 3-5 mm in front between floor profile and glazing and sealing 6-8 mm between floor profile and lateral glazings (all inside of greenhouse!)



T-Sealings Pos.1, 4, 7, 3 for all doors & windows (altogether 15 meter)

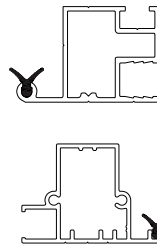

Attention!
At skylight - omit the side for insertion into ridge!!!

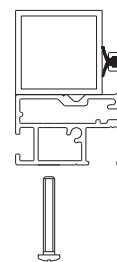

Attention!
Press sealing with the door at the bottom first and then screw down rectangular tube!

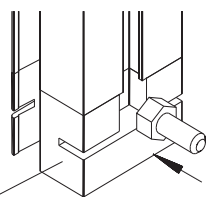

Fix PVC-glider in frame of doors at bottom, lateral and skylight stay bars

Hexagon bolts can be inserted later as well in the area of the PVC-glider!

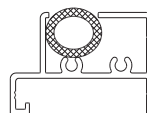

Tubing section Pos. 10 will be pressed into floor profile. (as buffer / sealing or protection against dirt in floor profile).

Please check according to tables if the components are complete
Contents of main box - basic construction-



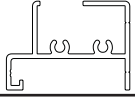
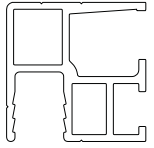
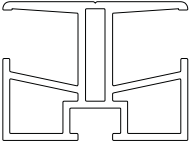



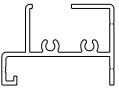
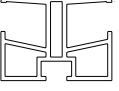
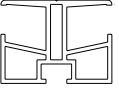
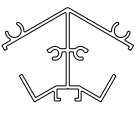
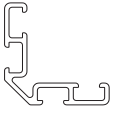



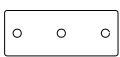

Profiles for both gables

Detail	Pos.	Designation	Amount/Length mm			
			Riga S		Riga	
			II	III	III	IV
	1.1	Floor profiles -gable-	2 2238	2 2238	2 2874	2 2874
	1.5.4	Edge stay bar left bent	2	2	2	2
	1.5.6	Edge stay bar right bent	1	1	1	1
	1.5.8	Edge stay bar right bent with boring for door locking device	1	1	1	1
	1.6	Frame of doors left Profile w. slope and boring	2 1854	2 1854	2 2037	2 2037
	1.7	Frame of doors right Profile with slope	2 1854	2 1854	2 2037	2 2037
	1.8	Frame of doors top	2 758	2 758	2 758	2 758
	1.8	Crossbeam in the side without door	1 758	1 758	1 758	1 758
	1.9	Crossbeam right + left	4 702	4 702	4 1020	4 1020

Profiles for eaves

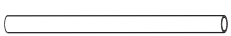
Detail	Pos.	Designation	Amount/Length mm			
			Riga S		Riga	
			II	III	III	IV
	2.1	Floor profiles -side-	2 2072	2 3130	2 3130	2 4188
	2.3.1	Lateral stay bar bent	2	4	4	6
	3.2	Cross stay bar/skylight	1 1018	1 1018	1 1018	1 1018
	3.3	Ridge profile	1 2137	1 3195	1 3195	1 4253
	3.4	Stabilizing /edge angle	4 2108	4 3166	4 3166	4 4225

Accessories bag basic construction

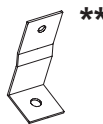
Detail	Position	Designation	Amount
	1	Angle bracket/floor profiles	4
	2	Connection sheet Verge flashing profile / frame of doors	4
	3	Connection sheet 35x90 fixing crossbeam-back wall	2
	4	Ridge-/grooved end plate	2
	5	Connection sheet, round for skylight crossbeam	2
	6	Angle/floor profiles 30x30x15 screwing down of corners from inside	4
	7	Cover Edge stay bar - Boring crossbeam	4
	8	Hexagon bolt M6x16 + nut for Stabilizing / edge angle	40*
	9	Plain washer for Pos.8 for Stabilizing / edge angle	20
	10	Tubing section 760 lg Sealing of door sill	1
	11	Wedge sealing 3-5 mm and 6-8 mm Sealing of inside floor profile	see table below
	12	Tallow-drop screw 4,2x13 Frame of do./cover sheet/angle pos.6	26*
	13	Tallow-drop screw 4,8x45 gable	6
	14		
 **	15	Fastening angles 74/30 x 33 -bent at right angles- for fixing of the greenhouse on foundation by customers (inapplicable with foundation frame!)	10

*plus substitute screws

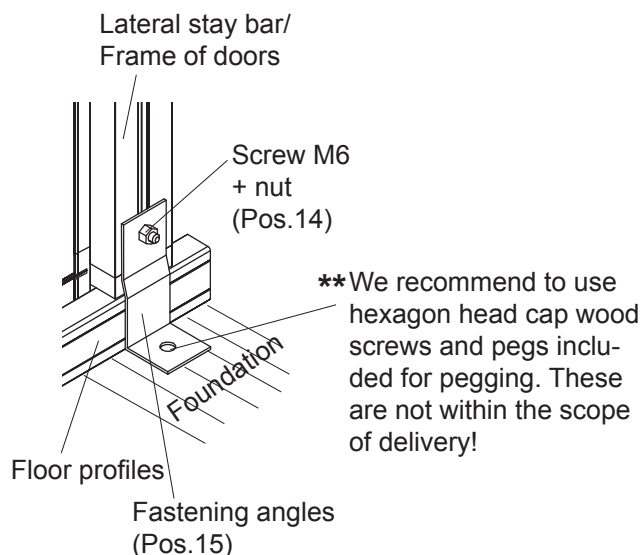

Type	Amount wedge sealings 3-5			6-8 mm
	length	712	768	1030
Riga S/II		4	1	4
Riga S/III		4	1	6
Riga III		-	1	10
Riga IV		-	1	12

Profiles for skylight

Detail	Pos.	Designation	Amount/Length	
	4.1	Window profile roof	2	541
	4.2	Window profile roof	2	953

Contents accessories bag skylight

Detail	Pos.	Designation	Amount/Length	
	1	T-sealing	2	641
	2	Assembly angle with setscrew	4	1052
	3	Allan key	1	
	4	Hexagon bolt M6x12 + nut	3	
	5	Angle bracket / skylight	4	

* **Annotation:** sealing is bunched in one hank for all the doors and windows, cut to size please.

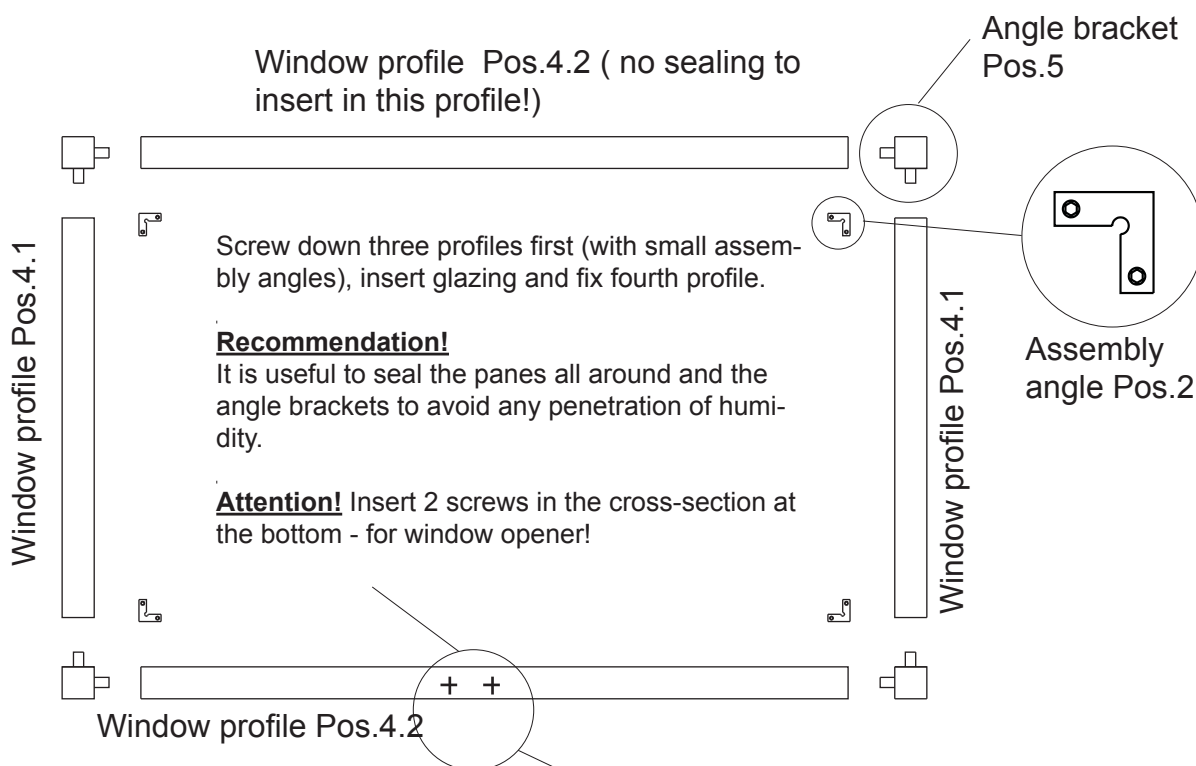

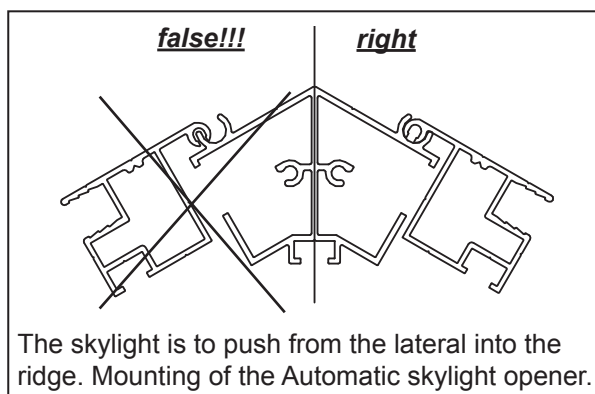

mounting skylight











Automatic skylight opener

Profiles for divided revolving door -at the bottom-

Detail	Pos.	Designation	Amount / Length
	5.3.1	Door profile at the bottom	3 700
	5.6	Door profile with borings for Sash lock left	1 734
	5.7	Door profile with hinge borings right	1 734
	5.9	Door profile with cross holes top	1 700
	5.8	Rectangular tube with cross holes	1 740

Accessories bag divided door at the bottom-

Detail	Pos.	Designation	Amount / Length
	1	Hinge	2
	2	Sash lock	1
	3	End cap for rectangular tube	2
	4	T-sealing	2 710
	5	Countersunk head screw 4,8x25 / hinges	2 744
	6	Countersunk head screw 4,2x45 / doors	4
	7	Countersunk head screw 3,5x22 / Sash lock	2
	8	Tallow-drop screw 3,5x38 / rectangular tube	2
	9	Glazing block 30x10x4	2

* **Annotation:** Sealing is bunched in one hank for all the doors and windows, cut to size, please.

View from outside



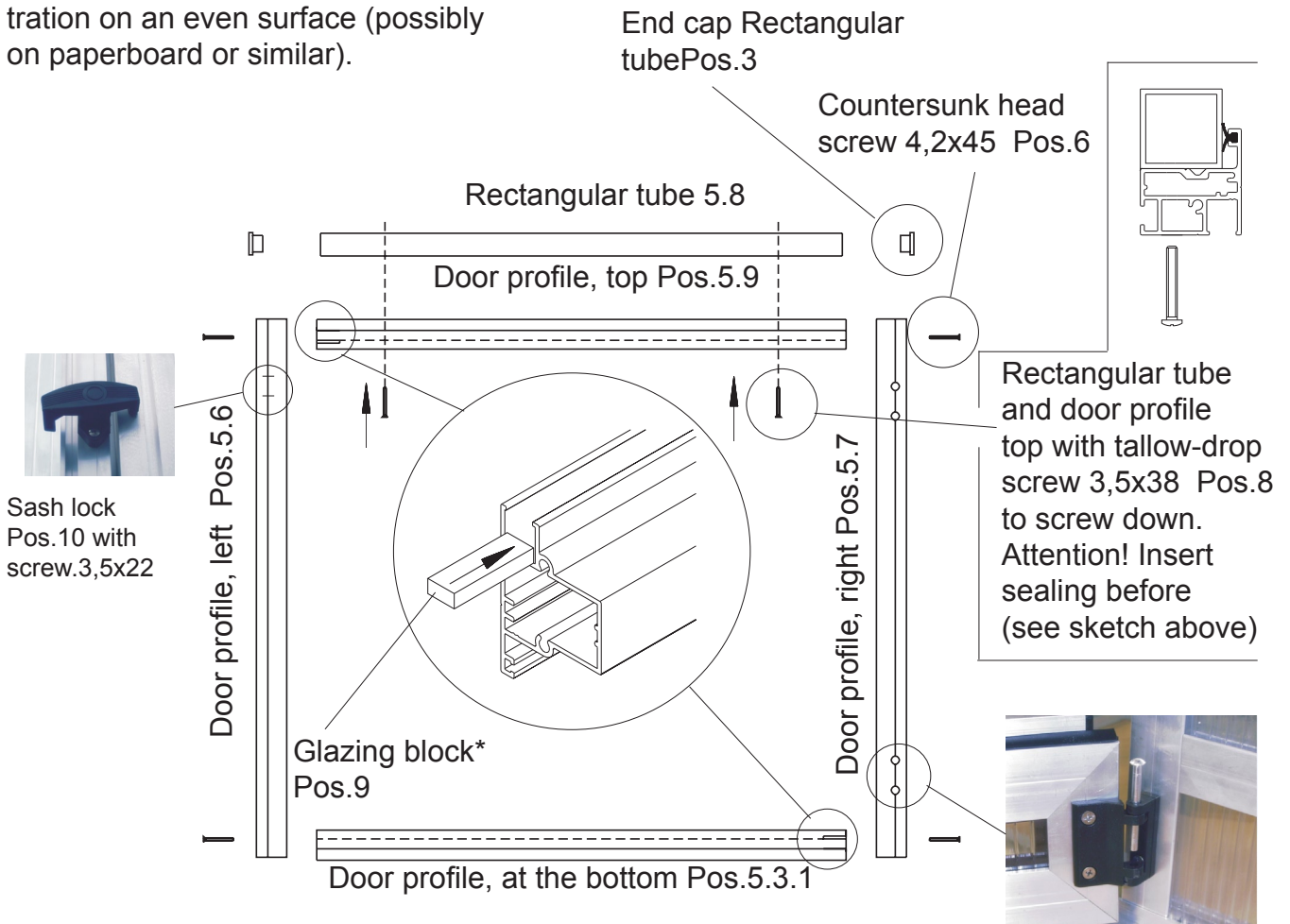



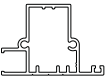

Lay out the profiles according to illustration on an even surface (possibly on paperboard or similar).

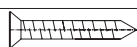

Profiles for Geteilte Drehtür -top-

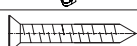

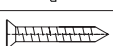
Detail	Pos.	Designation	Amount / Length
	5.1	Door profile left	1 x 1102 Rose / 1 x 1285 Orch.
	5.2	Door profile with hinge borings right	1 x 1102 Rose / 1 x 1285 Orch.
	5.3	Door profile top	1 700
	5.4.1	Door profile with boring at the bottom for lockable door handle	1 700

accessories bag -divided door -top-

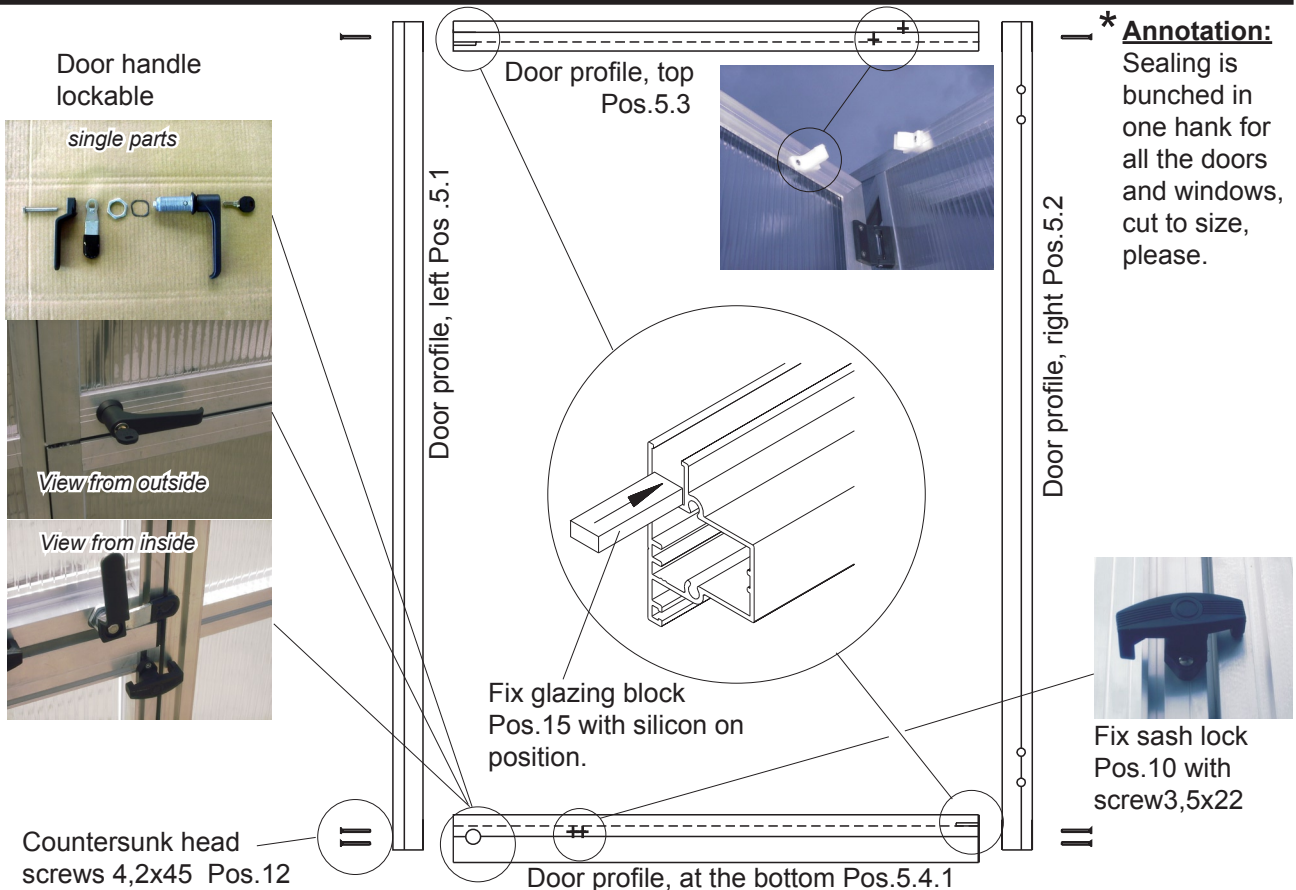









Detail	Pos.	Designation	Amount / Length
	1	Lockable door handle	
	5	Countersunk head screw 4,2x45 / Tür	6
	6	Glazing block	2
	7	T-sealing	2 x 710 2 x 1112 Rose/ 2 x 1295 Orch.
	8	Hinge	2
	9	Countersunk head screw 4,8x25 / hinges	8
	10	Sash lock	1
	11	Countersunk head screw 3,5x22 /hingesock	2
	12	Door locking device	1
	13	Tallow-drop screw 3,5x13/Door locking device	4

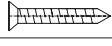
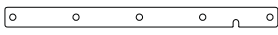

Profiles for back wall window

Detail	Pos.	Designation	Amount / Length
	5.1.2	Door profile with borings for sash lock left	1 x 1102 Rose / 1 x 1285 Orch.
	5.2.2	Door profile with hinge borings right	1 x 1102 Rose / 1 x 1285 Orch.
	5.3.1	Door profile top	1 700
	5.4.2	Door profile with borings for window opener bottom	1 700

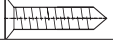
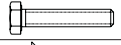
Accessories bag back wall window

Detail	Pos.	Designation	Amount / Length
	1	Countersunk head screw 4,2x45 / Fenster	6
	2	Glazing block	2
	3	T-sealing	2 x 710 2 x 1112 Rose/ 2 x 1295 Orch.
	4	Hinge	2
	5	Countersunk head screw 4,8x25 / hinges	8
	6	Sash lock	1
	7	Countersunk head screw 3,5x22 / Sash lock	2
	8	Window fixing	1
	9	Angle / window fixing	1
	10	Holder / window fixing	1
	11	Countersunk head screw 4,2x16 / Holder pos. 10	2
	12	Hexagon bolt M6x30 + nut	1
	13	Countersunk screw M6x20+lock nut	1
	14	Knurled nut -white-	1

*** Annotation:**

Sealing is bunched in one hank for all the doors and windows, cut to size, please.

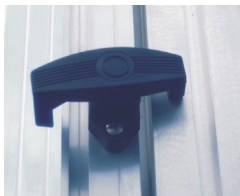

Fix sash lock Pos.10 with screw 3,5x22

Countersunk head screwn 4,2x45 Pos.12

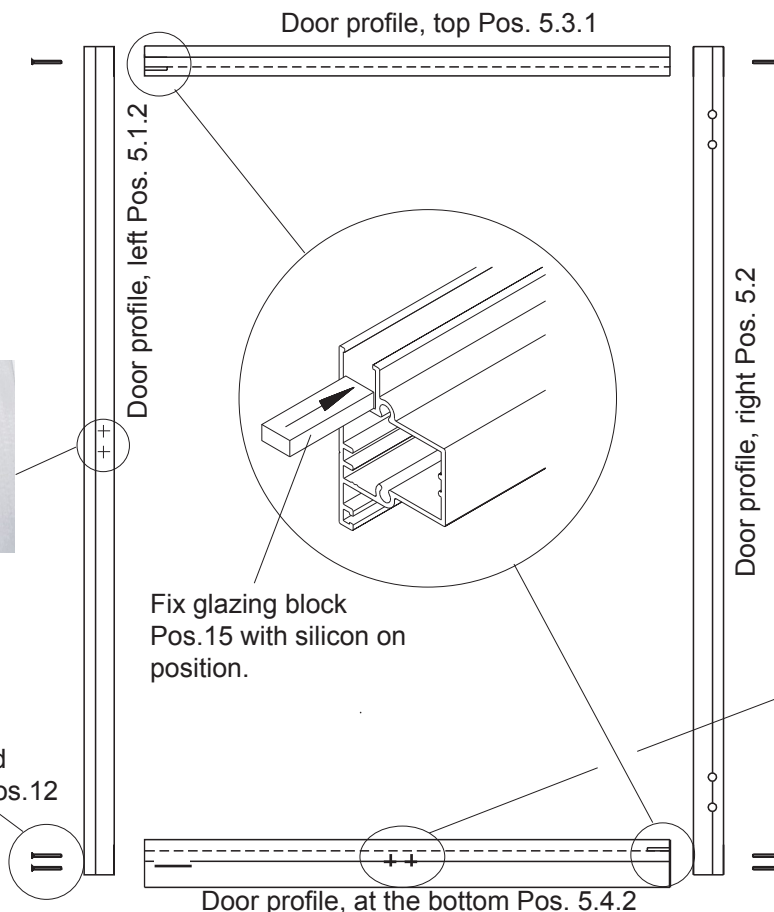





Back wall window opener



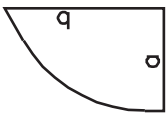
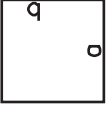

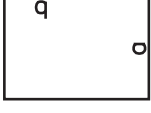
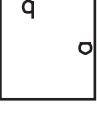
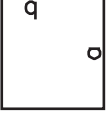
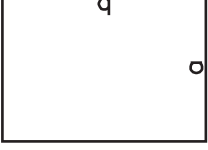
Window fixing with screw 4,2x16 to screw down

Plan of panes

Design type	pediment top	pediment buttom	pediment triangle	door and window	divided door buttom	back wall buttom	lateral pane	skylight pane	skylight pane buttom
									
	number dimension (a,b)	number dimension (a,b)	number dimension (a,b)	number dimension (a,b)	number dimension (a,b)	number dimension (a,b)	number dimension (a,b)	number dimension (a,b)	number dimension (a,b)
Rigo II S	4 730 x 1135	4 730 x 728	2 779 x 239	2 724 x 1031	1 724 x 676	1 787 x 728	3 1048 x 2634	1 974 x 565	1 1048 x 1984
Rigo III S	4 730 x 1135	4 730 x 728	2 779 x 239	2 724 x 1031	1 724 x 676	1 787 x 728	5 1048 x 2634	1 974 x 565	1 1048 x 1984
Rigo III	4 1048 x 1319	4 1048 x 728	2 779 x 239	2 724 x 1215	1 724 x 676	1 787 x 728	5 1048 x 3000	1 974 x 565	1 1048 x 2345
Rigo IV	4 1048 x 1319	4 1048 x 728	2 779 x 239	2 724 x 1215	1 724 x 676	1 787 x 728	6 1048 x 3000	2 974 x 565	2 1048 x 2345

Foundation frame (extra accessories)

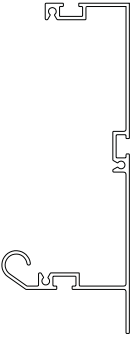
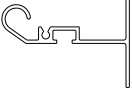
Profiles for foundation frame

Detail	Pos.	Designation	Amount/Length mm			
			Riga -S-		Riga	
	6.1	Foundation frame profile	2	2	2	2
			2199	2199	2835	2835
	6.2	Foundation frame profile	2	2	2	2
			2033	3091	3091	4149
	6.3	Angle bracket/foundation frame 40/40 x 135	4	4	4	4
			135	135	135	135
	6.4	Fixing plate (stay bar - foundation frame)	10	10	10	10
			135	135	135	135

Assembly of foundation frame

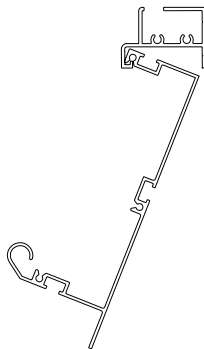

Each foundation frame is to turn into the floor profiles.
Pos.6.1 is intended for the gable side and Pos.6.2 for the side with the eaves.

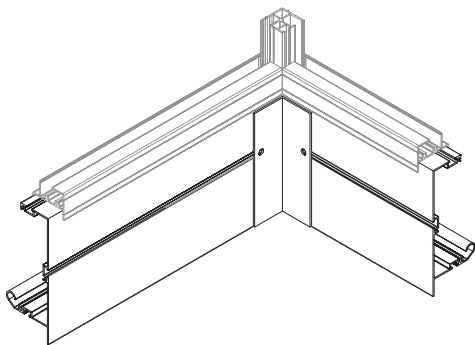

Insert one screw M6x12 into each of the corners of the foundation frame profiles, detach angles and screw down with nut M6.

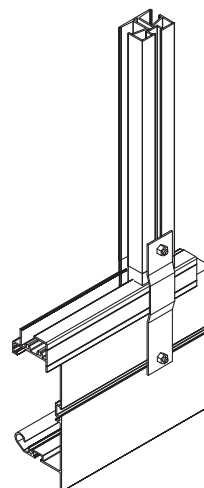

For stabilization purposes of the house some plates (Pos. 6.4) will be screwed on the foundation frame and lateral stay bars or frame of doors by means of pulled in screws M6.

Good advice for a quick and perfect assembly of the greenhouse from Hoklartherm

Most of the assembly can be done by you alone. The assembly for gable and lateral walls takes 2 – 4 hours according to your skills. It is best if you have further two persons being able to hold it for approx. half an hour when putting the greenhouse upright.

If you want to go on mounting it alone you have to look for a secure, suitable mounting course by means of stay bars, ladder or other fixings.

Unlike the most usual greenhouses, the mounting of the aluminum profiles is done together with the glazing. This results into an absolutely secure glazing and the biggest possible stability of the greenhouse.

You obtained 3 to 5 boxes depending on the greenhouse.

1 x basic kit → contents see p. 6 + 7

1 x windows and doors → contents see p. 8 – 11

1 x glazing (for bigger houses 2 boxes)

Please stay all the boxes in a dry place and protected against sunlight (see note below).

Please first open and unpack only the main box with the basic kit to avoid a mixing of the many different parts.

Please start with the assembly of the greenhouse gables. Door wall gable and back wall gable are nearly the same.

Push the profile of the frame of doors pos. 1.6 –right- and pos. 1.7 –left- (profile with 8 borings with a slope of 30° as well as a black PVC-glider) up to the smaller borings in the centre of the floor profile. The slopes there have to point to the outside direction. Then detach the angle brackets pos. 1 (see step 1).

Already now you need the small lateral glazing (measurements see table*). Push it with the web direction – vertical – into the floor profile and push laterally into the profile of the frame of doors (see step 2).

*Riga S	*Riga
730 x 728	1048 x 728

Important note:

The ISO-cellular sheets, that is the glazing, are always to build in with the UV-coated side to the outside. On the protection foil you find a corresponding note or a blue foil. Loosen the protection foils only at the edge and the complete rest of the foil only after the finished assembly . With some days of insolation the foil can burn "tight" on the plates and is to stripe off with difficulty.

Do not stripe it completely off when unpacking the goods because then you cannot see the side with the UV-protection.

Now detach the crossbeam pos. 1.9 from the top onto the glazing (see step 3). Then the beveled glazing is to put in the same way. Joint the frame of doors with the connection plate pos. 2 (see step 4).

Attention!

In advance 2 screws have to be screwed in both vertical frames of doors and 2 screws into the horizontal frame of doors.

On the square head of the angle bracket you detach the edge stay bars pos. 1.2 + pos. 1.3 (length 1447 mm). Take care that the groove is on the top! Do not position any triangular glazing onto the frame of doors.

The verge flashing profiles in pos. 1.4 and 1.5 must be detached onto the slopes and be joined together with the profile of the frame of doors by means of a trapezoid clamping plate. At the verge flashing profile with two sheet metal screws 4,2 x 13, at the profile of the frame of doors with M6 x 12 (see step 4 + 5).

Screw down the crossbeam by means of sheet metal screws 4,8 x 45 (see step 6).

Note 1: If the profiles have any PVC-gliders you can still later push in the required screws through the opening of the PVC-glider!

Note 2: One verge flashing profile (pos. 1.3.3.) has two small openings for the fixing of the door locking device, thus you have to determine now where the door should be mounted.

The back wall gable is to assemble the same way. Please build in one crossbeam in pos. 1.8 (length 758 mm) exactly in the height of the already existing crossbeams. Fix with the rectangular connector 35 x 90 with 3 borings (see step 7).

Attention! Here you put in the glazing 787 x 728 mm before! The above remaining opening will be closed later by the intended standard back wall window.

Assembly of the lateral and roof segments (see steps 8 - 15)

Now you need some more assistance or corresponding aids!

Set the gable upright, hold it or support it safely (see step 8).

At first the lateral floor profiles (measurement see table*) are to detach on the angle bracket of the gable (see step 8).

The ridge profile is now to introduce into the existing nuts / slots of the gable that the profile is flush in the front. Now screw together with the ridge / grooved end plate by means of sheet metal screws 4,2 x 13 (see step 9).

A lateral glazing is to push into the floor profile and the edge profile. It is best, if at both sides. Thus the gable stands safely (see step 10).

*Riga II S	2167 mm
*Riga III S	3225 mm
*Riga III	3225 mm
*Riga IV	4284 mm

The next is to push in a pane of the skylight glazing into the grooved profile and into the verge flashing profile. Introduce roof stay bars into the grooved profile and eaves profile and push up until the glazing (thread-up glazing). The remaining panes are to complete.

Please determine the position of the window in time!

Here put in the short pane of the skylight glazing and close with the window crossbeam pos. 3.2. The round connection plates have to be used to screw (see step 12).

Now the second gable in the foot is to connect with the floor lengthwise profile in the same way already known. Push the grooved profile and ridge profile into the nuts / slots of the gable profiles. Screw down as well with the grooved and ridge end plates.

Now a small angle 30/30/20 x 2 can be screwed in by means of sheet metal screws 4,2 x 16 to secure the floor profiles (see step 15). If you use a foundation frame this angle not urgently necessary, as the foundation frame has an L-connection (see p. 13).

The stabilizing / edge angles (pos.3.4) are to fix at the edge stay bars and lateral stay bars by means of screws M6x16 and plain washers. These have a stabilizing effect and give a protection of the greenhouse against stormy weather. At the same time these angles are the back wall profiles for the tables and shelves (see separate mounting instruction).

Now the skeletal structure is finished – topping-out ceremony is the order of the day!

Please open now the accessories box. Here you find:

1 pc skylight including automatic window opener	contents see p. 8
1 pc divided revolving door	contents see p. 9 + 10
1 pc back wall window	contents see p. 11

These parts are to mount according to the instructions (see p. 8 – 11).

Doors and back wall window can be mounted at both gables. Borings for the door hinges / bands exist in every right profile of frames of doors. However, please take care that we have intended the borings for the door locking device at only one verge flashing profile (see step 5). Should you mount the door on the other side, the corresponding borings have to be transferred then.

The skylight is to push from the lateral into the ridge (see step 15). This system is generally very simple and explains itself.

Further useful notes:

Erection with a foundation frame:

This is the simplest but also the securest erection of a greenhouse. The foundation frame is hooked non-positively into the floor profile of the greenhouse and screwed down in the edges by an angle bracket (see p. 13).

It is best and easiest to assemble the foundation frame together with the greenhouse! But this is also possible later – without any energy. Then you only must lift the greenhouse (it is best to do this at one side) and laterally hook in the foundation frame into the floor profile.

Erection with the foundation frame:

At first you have to dig a small ditch, cut of the spade approx. 10 – 12 cm deep, according to the given measurements of the foundation frame. In each of the four corners you horizontally place a cobblestone as a support for an exact level compensation. This avoids a possible sinking of the greenhouse. Then the greenhouse with the foundation frame is to put in this ditch and the foundation frame is to fill by the excavated material. It is useful to lay down there some garden plates or flagstones in order to avoid any dirty splashes at the greenhouse due to strong rain. Besides, working around the greenhouse is simpler, e.g. mowing the lawn.

Question: Is it necessary to „seal“ the greenhouse or greenhouse glazing respectively ?
Principally: not.

However, we recommend to seal the horizontal transitions from the glazing to the profile (see sketch → broken lines ---) with neutrally linking, transparent silicon in order to have the most possible small amount of water and thus little dirt in the glazing reception.

Advantage: In the long term the greenhouse has a better appearance. The tendency to the algae formation just in this area decreases tremendously.

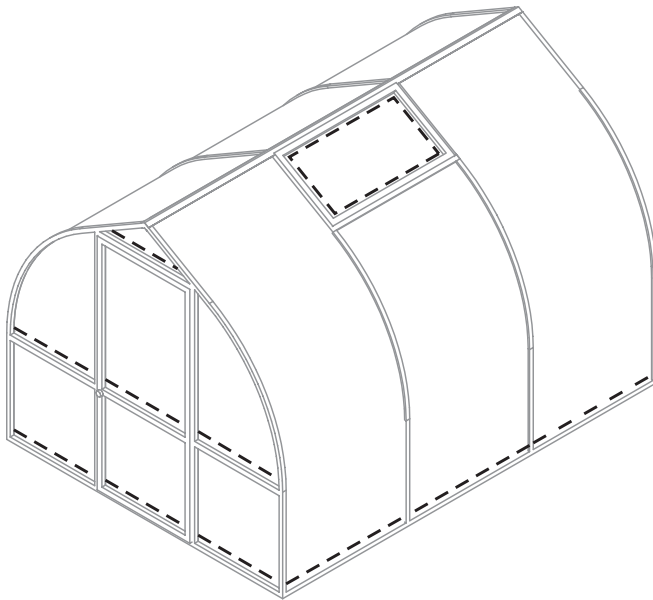

Humidity / water can also appear within the glazing/cellular sheets according to the weather situation because the PVC-sheets are not "steam-diffusion-tight", that means that humidity in the form of steam penetrates into the sheet. This is a purely optical disadvantage which cannot be avoided.

The sheets cannot suffer any damage, even not with frosty days.

Attention: Use only „neutrally linking“ silicon due to possible stress cracks in the PVC-glazing. This is

the most common silicon sealant being available with any DIY superstore or with your Hoklartherm expert dealer priced at 4 – 6 € / 310 mm cartridge.

Cleansing and maintenance:

Clean the greenhouse with much water only (for ex.: with a car wash-brush or a HP-cleaning apparatus. You can additionally use any purifiers.

We wish all the buyers and users of this Hoklartherm-greenhouse much fun with their hobby of gardening and have much success with growth!

All our statements are based upon many years of experience and are drawn up to the best of our knowledge and belief and they do not cover any legal entitlements in case of any possibly arising events of claim.



Foundation plan Riga S / Riga

all the dimensions in [cm]

Establishment of your greenhouse with a "stipe-foundation"

If you did not buy a foundation frame, the greenhouse has to be erected safely by means of a strip-foundation.

Please arrange then such a foundation according to the dimension presets given below.

You also have the possibility to found your greenhouse on flash kerb edge beams.
(for ex.: 50 x 25 x 8 cm or better 50 x 30 x 10 cm)

Please pay attention to the foundation being even and horizontal.

Then fasten the greenhouse by the supplied angels with dowels 8/10 mm (2 pcs. per side minimum) into the concrete.

Screws and dowels is not a part of the delivery

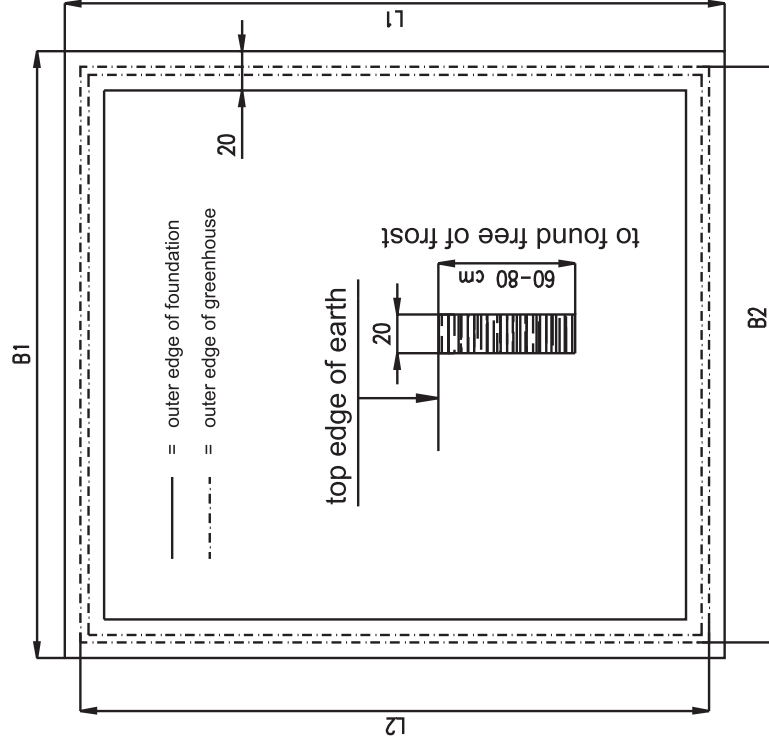

	foundation		greenhouse	
	B1	L1	B2	L2
Rose S II	249	232	233	216
Rose S III	249	338	233	322
Riga III	312	338	296	322
Riga IV	312	443	296	427