

Owner's Manual

 **BONAIRE**[®]
Durango



Evaporative Air Cooler

Durango Portable cooler 1500



DO NOT return to store

For help with installation or warranty issues

Call: 800-939-2983 or

Visit: www.bonaire-usa.com

For parts, visit our secure website:

www.bonairedurango.com

IMPORTANT

READ AND SAVE THESE INSTRUCTIONS.

Please keep this important manual in a safe place.

It is the owner's responsibility to ensure that regular maintenance is carried out on this evaporative cooling product. Failure to do so will void all guarantees beyond statutory and legal requirements.

Disclaimer

Climate Technologies reserves the right to make alterations to specifications, quantities, dimensions etc. for production or other reasons, subsequent to publication. While we believe the information is accurate and complete, we make no warranty or representation for any particular purposes. The information is offered in good faith and with the understanding that any use of the units or accessories in breach of the directions and warnings in this document is at the sole discretion and risk of the user.

1. General Safety Information

Thank you for purchasing a quality Bonaire Evaporative Portable Cooler. We care about your safety and would ask you to spend a few minutes reading these simple instructions before operating this product.

Safety!



Read carefully prior to attempting to assemble, install, operate or maintain the unit.

- **Read and save these instructions. Do not throw these instructions away**
- **Complete the unit assembly before attempting to operate.**
- Interference with and operation of this cooler in any manner not prescribed by these instructions could cause a safety issue and **WILL** void any warranty.

WARNING:

- Do not use cooler on uneven or unstable surfaces.
- Do not overfill. Use water only.
- Do not operate cooler with Rear Filter Panel removed.
- Do not insert any foreign objects or body parts into the air inlet or outlet, otherwise bodily injury or property damage may occur.
- Do not use immediately adjacent to heat sources such as stoves or radiators.
- Do not use immediately adjacent to sources of water, such as swimming pools, hot tubs, bathtubs, showers, sinks or other liquids.
- Do not operate this product near an open flame or the product may ignite and cause fire, resulting in bodily injury or property damage.
- Do not operate in areas where gasoline, paint or other flammable liquids or vapours are used or stored.

WARNING:

- All electrical connections must comply with local construction and safety regulations and be performed by qualified personnel.
- The power cord should be connected directly to a 120VAC +/-10%, 60 Hz, 1 phase only grounded GFCI protected electrical receptacle. Make sure that the power switches are in the off position before connecting and operating your cooler.
- Do not use this product with any solid- state speed control device.
- Keep the cord away from heated surfaces.
- Do not operate cooler with a damaged cord, plug or other components.
- Do not step on or roll over the power cord with heavy or sharp objects.
- Do not run the power cord under carpet or other floor covering. Arrange cord away from traffic area and where it will not be tripped over.

- Do not use the power cord with an adaptor plug that converts the 3-pin plug into a 2-prong connector.
- If the power cord is damaged, it should be replaced by a service agent or qualified personnel to avoid risk of bodily injury or property damage.
- Remove the plug from the electrical receptacle by pulling on the plug and not the cord.
- Use only qualified electricians for replacement or servicing of switches, or electrical motors and components in this cooler.
- If damaged, discard cooler or return to an authorized service facility for examination and/or repair.
- Unplug or disconnect the appliance from the power supply before servicing.

WARNING:

- Always unplug the power cord from the wall outlet receptacle when the air cooler is not in use, before adding water, before cleaning, before removing cooling pad, before maintenance and replacing parts, or before moving to another location for servicing.
- Do not plug the cord into electric outlet with wet hands or an electric shock may result. The same applies for unplugging.
- Never wash the unit cabinet with a garden hose. water may harm the motor and electrical system.
- Never attempt to disassemble or alter the product in any way not instructed by this manual. Shock, fire, or bodily injury may occur.
- Do not allow children to operate or service this cooler.

WARNING:

Stagnant water may cause bacterial growth and serious health problems. Do not allow stagnant water to remain in the tank.

- Drain and clean the water tank before storage, after seasonal use and whenever the unit is not in daily use.

2. Product Description

The Evaporative Air Cooler is an efficient, energy-saving product. It cools by combining water evaporation with air movement, through carefully designed and manufactured equipment, providing maximum efficiency and safety.

The evaporative cooling technology is very economical and gives a number of additional benefits compared to traditional air conditioning systems for homes and businesses. The system does not use refrigerants or compressors; it cools by simply moving air through a surface composed of specially designed evaporative cooling pads.

Heat from the inlet air is absorbed by the water. The resulting outlet air temperature drops when the water transforms into gas. Humidity is not perceived, since the air in the room is renewed approximately every two minutes, while a comfortable cooling effect is created. Continuous air circulation is a vital aspect of the evaporative cooling process used in this equipment and gives it a distinct advantage over air conditioning by refrigeration.

3. Unpacking

Handle the unit with care. Visually inspect for shipping damage. If any part is damaged, immediately file a claim with the carrier.

4. Product Specifications

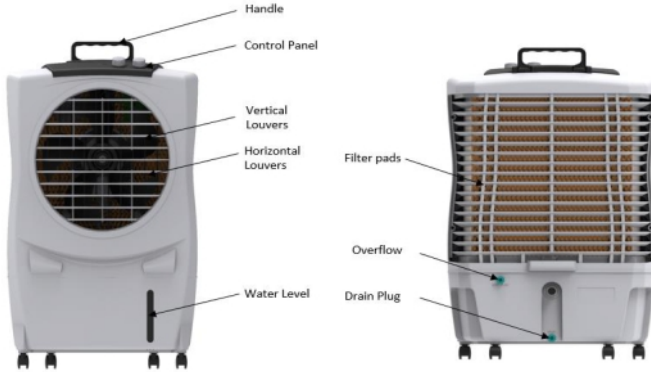

Model	Durango Portable cooler 1500 CFM
Voltage	110-120 VAC, 60 Hz, 1 phase
Amperage	0.72 A
Tank Capacity	4.35 gal (16.5L)
Unit Weight	13.8 lbs (6.3kg)
Dimensions: inches (cm)	H: 27.5" (69.8 cm) X W: 17.7" (44.7 cm) X D: 12.0" (30.4cm)

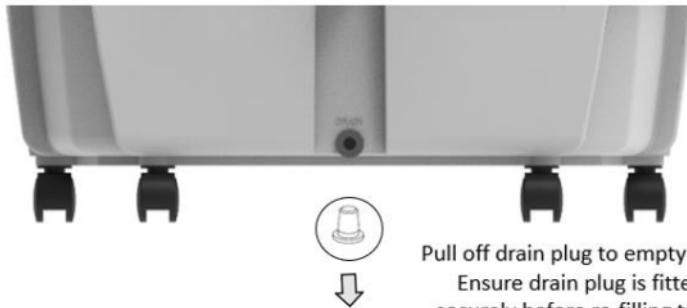

5. Electrical Connection and Installation

Review and understand the warnings in the [General Safety Information](#) section, page 2 & 3.

1. Install the cooler with castors on flat surface
2. Adjustable Up and Down louvre: The Up and Down Louvres can be adjusted using the protruded tab.
3. Add clean water into the water tank through water inlet door as circled in the image. Check the water level window on the front of the cooler to see when the water tank is full.
4. Plug the unit into a 120 VAC ($\pm 10\%$) 60 Hz, 1 phase GFCI protected grounded outlet.



6. Operation

Control Panel

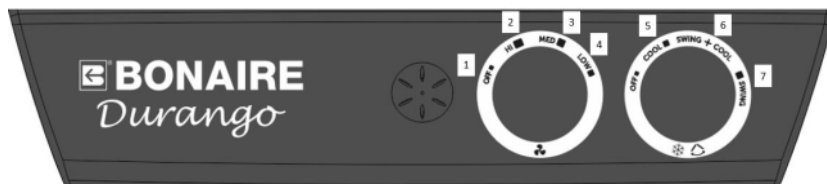

There are 2 control knobs on the Panel. Left knob controls the power and fan speed of the Unit. The other knob control cool and swing.

No 2, 3 and 4 are high, medium, and low fan speeds.

No 5 - is for the Cool function which switch the pump on.

No 6 - Keeps the pump on and switch on the swing function.

No 7 - is swing only. In this function it switches off the pump.

Air Renewal Requirements:

When your cooler is working, it is important to leave a window or door open in order to keep a constant air flow and to avoid any accumulation of humidity and heat. Your Evaporative Cooler does not cool correctly when air flow is restricted from exiting a room. This causes a decrease in the cooling efficiency due to an increase of humidity.

7. Maintenance

⚠ WARNING

Stagnant water may cause bacterial growth and serious health problems. Do not allow stagnant water to remain in the tank.

Drain and clean the water tank before storage, after seasonal use and whenever the unit is not used for a long time period.

Changing the filter pads:

Please follow the instructions below in order to change the filter pads.

- 1- Open the control panel snaps & Open two screws shown by Arrow. (As shown by arrows).

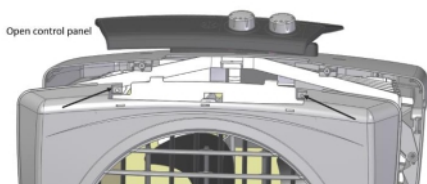

- 2- Open 4 screws shown by arrows

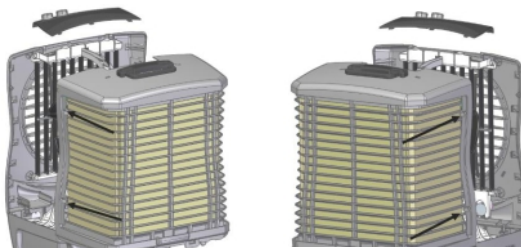

3. Open bottom screw as shown by arrow

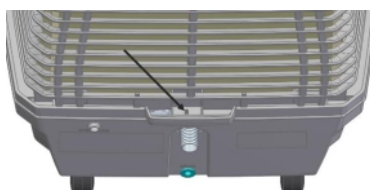

4. Clean filter pad properly.
5. Assemble in reverse order, ensuring the panels are fitted correctly with no gaps or tabs left outside.

8. Wiring Diagram

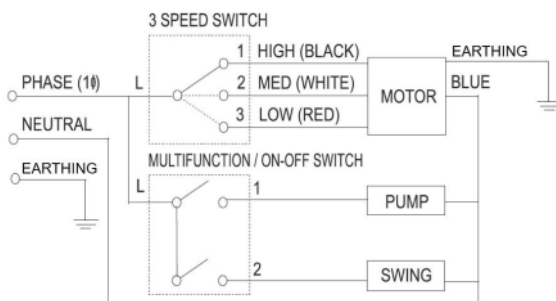

9. Troubleshooting

Problem	Reason	Solution
No air flow	<ol style="list-style-type: none"> 1. Power is not connected. 2. Power is not turned ON. 3. Body damaged. 	<ol style="list-style-type: none"> 1. Plug in the power cable properly. 2. Press the Air Speed button to start. 3. Return to Service Center.
Abnormal Sound	<ol style="list-style-type: none"> 1. Foreign article inside body of unit. 2. Loose air fan. 3. Motor defect. 	<ol style="list-style-type: none"> 1. Remove rear cover and wet pad, remove foreign articles. 2. Return to Service Center. 3. Return to Service Center.
No evaporation/Cooling	<ol style="list-style-type: none"> 1. Water tank is clogged. 2. Other cause. 	<ol style="list-style-type: none"> 1. Clean the water tank. 2. Return to Service Center.
Air flow direction cannot be controlled	Swing motor is defective.	Return to Service Center

10. Supplier's Declaration of Conformity

- a. This device complies with part 15 of the FCC rules.
- b. Responsible supplier listed as per SDoC:
Bonaire USA LLC.
Contact 800-939-2983 or www.bonaire-usa.com

11. Warranty

Statement on Product Warranty (U.S.A.)

1. Warranty

Subject to the Conditions and Exclusions, Climate Technologies Pty Ltd provides the original purchaser with the following warranty:

Climate Technologies Pty Ltd warrants these appliances: Bonaire Durango Portable cooler 1500, for a (2) two-year period (parts only) from the date of purchase. During this period, a defective appliance or defective parts will be repaired or replaced free of charge at the election of Climate Technologies Pty Ltd. In addition, Lifetime cabinet corrosion parts only warranty on the unit cabinet applies.

Climate Technologies Pty Ltd, makes no warranties, representations, or promises as to the quality or performance of its evaporative coolers other than those specifically stated in this warranty.

2. Conditions and Exclusions

- a) The warranty only covers portable coolers supplied by Climate Technologies Pty Ltd and purchased in the U.S.A.
- b) The warranty does not cover installation components that may be attached to the product manufactured by Climate Technologies Pty Ltd. These may include and is not limited to items such as ducting, flues, grills, piping, etc. These items remain solely the responsibility of the installer / owner.
- c) This warranty is only valid if the appliance is installed and operated in accordance with the manufacturer's instructions and for its designed and intended purpose at the nominated phase, voltage and frequency.
- d) Product fitness for purpose and overall system design / sizing are solely the responsibility of the installer / owner. This includes but is not limited to heat load calculations, air flow, system balancing, humidity, water quality, etc.
- e) Industrial or commercial use of this product will void the warranty. The appliance is designed for domestic use only.
- f) The product must be installed by a qualified person in the manner prescribed by local and statutory regulations and to the manufacturer's specifications.
- g) Warranty will only be given where proof of purchase is provided by the original purchaser and Climate Technologies Pty Ltd is satisfied that the appliance is within the warranty period.
- h) Warranty will not be provided where, in Climate Technologies Pty Ltd opinion:

- i. There is nothing wrong with the appliance.
 - ii. The defective operation of the appliance is due to failure of electricity or water supply.
 - iii. Defects are caused by neglect, incorrect application, abuse, normal wear and tear or by accidental damage of the appliance.
 - iv. An unauthorized person has attempted to repair the appliance.
 - v. The appliance has been changed or modified in any way.
 - vi. A situation arises referenced in the trouble-shooting guide.
- i) Damage caused by elements such as wind, rain, lighting, floods, etc. along with power spiking and brownouts are not considered defective material or workmanship and as such are not covered by our warranty.
 - j) If there is no certificate of compliance for plumbing or electrical work, Climate Technologies Pty Ltd reserves the right to refuse warranty on non-compliant installations.
 - k) No responsibility will be accepted for outside elements such as pests, animals, pets and vermin that may cause damage to the unit.
 - l) Harsh environmental situations such as salt air that may cause damage are not covered.
 - m) Responsibility or liability is not accepted for damage to contents, carpet, walls, ceilings, foundations or any other consequential loss or damage of whatever nature either direct or indirect resulting from installation, operation or misuse of the appliance.
 - n) Parts replaced under warranty are warranted for the balance of the original Warranty Period.
 - o) All warranties are non-transferable.
 - p) The benefits conferred by this warranty are in addition to warranties and other rights in respect of the appliance, which the consumer has under State and Federal laws. This warranty must be read subject to that legislation and nothing in this warranty has the effect of excluding, restricting or modifying those rights.

3. How to obtain service

Subject to the aforementioned conditions and exclusions, Climate Technologies Pty Ltd will repair or replace (at its discretion) any evaporative cooler which, after examination, is determined to be defective for the duration of warranty delineated in "Warranty" section. Bring the evaporative cooler in need for service to the nearest authorized retailer special service desk. A copy of proof of previous replacement must also be included if applicable. Maintain the original documents for future reference.

The authorized retailer and Climate Technologies Pty Ltd will assess your product and provided paperwork to confirm the 1-year limited warranty is still valid. If any items in the "Conditions and Exclusions" section are found, then the 1-year limited warranty is

null and void. A valid, legible product serial code must also be visible to obtain service under the Climate Technologies Pty Ltd evaporative cooler 1-year limited warranty. If the authorized retailer and Climate Technologies Pty Ltd deem that a product cannot be serviced and a replacement is necessary, a similar product of equal or greater value will be shipped to you free of charge by Climate Technologies Pty Ltd.

4. Climate Technologies Pty Ltd

Climate Technologies Pty Ltd is a company incorporated in Australia (A.C.N. number 001 418 042). Reference to Climate Technologies Pty Ltd includes its authorized distributors.

Warranty for Replacement Parts.

Parts replace under warranty are warranted for the balance of the Cooler’s original warranty period.

Proof of Purchase

Please attach your proof of purchase here. Your receipt is your warranty and will be required to validate any warranty.

Dealer / Product Information

Dealer/Retailer:	
Address:	
Phone Number:	
Unit Model Number:	
Serial No:	

ACCEPTANCE OF THE EXCLUSIVE REPAIR AND REPLACEMENT REMEDIES DESCRIBED HEREIN IS A CONDITION OF THE CONTRACT FOR THE PURCHASE OF EVERY CLIMATE TECHNOLOGIES PTY LTD EVAPORATIVE COOLER PRODUCT. DETAILS OF THIS LIMITED WARRANTY ARE SUBJECT TO CHANGE WITHOUT NOTICE. IF YOU DO NOT AGREE TO THIS CONDITION, YOU SHOULD NOT PURCHASE THE PRODUCT. IN NO EVENT SHALL CLIMATE TECHNOLOGIES PTY LTD BE LIABLE FOR ANY INCIDENTAL, SPECIAL, CONSEQUENTIAL OR PUNITIVE DAMAGES, OR FOR ANY COSTS, ATTORNEY FEES, EXPENSES, LOSSES OR DELAYS ALLEGED TO BE AS A CONSEQUENCE OF ANY DAMAGE TO, FAILURE OF, OR DEFECT IN ANY PRODUCT INCLUDING, BUT NOT LIMITED TO, ANY CLAIMS FOR LOSS OR PROFITS. SOME STATES DO NOT ALLOW THE EXCLUSION OR LIMITATION OF INCIDENTAL OR CONSEQUENTIAL DAMAGES, SO THE ABOVE LIMITATION OR EXCLUSION MAY NOT APPLY TO YOU. THIS WARRANTY IS EXCLUSIVE AND IN LIEU OF ALL OTHER EXPRESS WARRANTIES, WRITTEN OR ORAL. TO THE EXTENT PERMITTED BY LAW, CLIMATE TECHNOLOGIES PTY LTD DISCLAIMS ANY IMPLIED WARRANTIES, INCLUDING WITHOUT LIMITATION, ANY IMPLIED WARRANTY OF MERCHANTABILITY OR FITNESS FOR A PARTICULAR USE OR PURPOSE; TO THE EXTENT SUCH DISCLAIMER IS NOT PERMITTED BY LAW, SUCH IMPLIED WARRANTIES ARE LIMITED TO THE DURATION OF THE APPLICABLE EXPRESS WARRANTY AS DESCRIBED ABOVE. SOME STATES DO NOT ALLOW LIMITATIONS ON HOW LONG AN IMPLIED WARRANTY LASTS, SO THE ABOVE LIMITATION MY NOT APPLY TO YOU. THIS WARRANTY GIVES YOU SPECIFIC LEGAL RIGHTS, AND YOU MAY ALSO HAVE OTHER RIGHTS WHICH VARY FROM STATE TO STATE.

www.bonairedurango.com