



BedTech

ADJUSTABLE BASES

BT6500

OWNER'S MANUAL

Installation & Operation



Serial No.

Safety & Warranty Warnings	01
Parts List	03
BT6500 Electronics Quick Reference Guide	04
Installation Guide	05
BT6500 Remote Control Instructions	06
BT6500 Bluetooth Instructions	07
Setting Programmable Positions and Pairing Remote.....	08
Synchronizing Two Bases.....	09
Headboard Bracket Installation Guide	10
Troubleshooting	11

READ THE FOLLOWING INFORMATION CAREFULLY BEFORE USING THIS PRODUCT

If unable to understand warnings, cautions, and/or instructions, contact the dealer or technical personnel if applicable, before attempting to use the equipment. Otherwise, injury or damage may result.

SAFETY WARNINGS:

- Do not use bed outdoors.
- Do not use bed near explosives.
- Using bed with oxygen administering equipment other than the nasal masked type creates a possible fire hazard.
- When using nasal or masked type administering equipment, route and secure oxygen or air tubing properly to ensure that tubing does not become entangled or damaged during normal operation of the bed.
- Use caution when having liquids in or around the bed to ensure no spilling occurs. In case of spillage, stand in a dry, clean area of the floor and unplug the bed immediately. Clean up spill and allow the area around bed to dry thoroughly before using the electric controls again. Do not eat or drink hot liquids while operating the bed.
- This appliance is not intended for use by persons (including children) with reduced physical, sensory or mental capabilities, or lack of experience and knowledge, unless they have been given supervision or instructions concerning use of the appliance by a person responsible for their safety.
- Do not allow children or individuals with disabilities to operate the bed without adult supervision.
- Do not allow any person or pet under the bed at any time.
- During bed operation, make sure body is positioned within the confines of the bed. Do not place extremities over the sides of the bed when operating bed functions.

WARRANTY WARNINGS:

Do not open or tamper with control box, motors, or remote (with the exception of battery compartments). The warranty will be void if the internal workings of these components are tampered with.

Product Rating:

The motors are not designed to operate continuously for more than [2] minutes in an [18] minute time period or approximately 10% duty cycle. Attempting to circumvent or exceed this rating will shorten the life expectancy of the foundation and may void the warranty.

Operating Information:

- After power foundation assembly is completed, operate remote control to ensure proper functions.
- Keep moving parts free of obstruction during bed operation (including sheets, clothing, tubing, wiring, and products using electric power cords).
- Distribute body weight evenly over bed surface. Do not place entire weight on head or foot sections of the bed during repositioning and entering or exiting bed.

Hospital Use Disclaimer:

This power foundation is designed for residential use only. It is not approved for hospital use and does not comply with hospital standards.

Weight Limits:

This product is not rated to support weights in excess of 850 pounds inclusive of the mattress and bedding. The bed will structurally support this weight, provided it is evenly distributed across the foundation. The power foundation is not designed to support or lift this amount in the head or foot sections alone. Exceeding this weight restriction could damage the bed and/or cause injury and will void the warranty.



RADIO FREQUENCY: 2.4 GHZ

FCC COMPLIANCE:

This device complies with Part 15 of the FCC Rules. Operation is subject to the following two conditions: (1) This device may not cause harmful interference, and (2) this device must accept any interference received, including interference that may cause undesired operation.

To comply with the FCC RF exposure requirements, no change to the antenna or the device is permitted. Any change to the antenna or the device could result in the device exceeding the RF exposure requirement and void user's right to operate the device.

BED-TECH WARRANTY ADJUSTABLE BASES

In the warranty: “Adjustable base” means the adjustable bed foundation sold by Bed-Tech to an authorized dealer. The “adjustable base” does not include the mattress. “Purchaser” and “You” both mean the consumer who is the original purchaser of this adjustable base produced by Bed-Tech. This warranty is not transferable. “Warranty Commencement Date” means the date You purchased a new and unused Bed-Tech adjustable base. Bed-Tech warrants this adjustable base to You on the terms and over the reducing periods of time set out below. All warranty claims require notice from You to be given to Bed-Tech in the manner set out below, and to be received by Bed-Tech inside the applicable warranty time period.

1ST & 2ND YEAR FULL WARRANTY

For the 1st and 2nd year from the Warranty Commencement Date, your adjustable base is warranted against non-excluded defects in Bed-Tech’s workmanship or materials. During the 1st and 2nd year from the Warranty Commencement Date, Bed-Tech will repair or replace (at no cost to You) any defective adjustable base part, and Bed-Tech will pay all authorized labor associated with the repair or replacement of any parts found to be defective. In the case where adjustable base needs to be replaced, Bed-Tech does not cover or pay for any part of transportation costs.

3RD THROUGH 15TH YEAR LIMITED WARRANTY

During the 3rd through end of the 15th year from the Warranty Commencement Date, Bed-Tech will cover a 50% prorated portion of any electronic part not excluded by this warranty. You are responsible to pay all service costs related to receiving and installing the new part. Electronics covered include: motor, control box, power supply, remote control, control box, massage motor, LED light, and USB charging port. Bed-Tech will pay for and cover the cost of shipping parts to the lower 48 states only. Customer will be responsible to pay 50% of the parts cost that the prorated warranty does not cover. For example, if you make a claim for an eligible motor and the part costs \$129 you would be responsible to pay \$64.50.

3RD YEAR TO 20TH YEAR LIMITED WARRANTY

Starting in the 3rd year from the Warranty Commencement Date and through to the end of the 20th year from the Warranty Commencement Date, Bed-Tech will replace any steel base parts found to be defective and not excluded by this warranty. This warranty only covers the steel mechanism frame. Bed-Tech will provide at no cost to You the metal parts for the defective frame. You are responsible to pay all service and transportation costs related to receiving and installing the new part. In the case of a defective steel base, if shipping costs and labor costs are excessive, customer may choose a 50% prorated warranty and receive a new same or comparable model for 50% of customer's purchase price. Customer is responsible for all and any shipping costs associated with this warranty.

ADDITIONAL TERMS AND CONDITIONS EXCLUSIONS:

This warranty does not apply; (a) to any damage caused by You; (b) if there has been any repair or replacement of adjustable base parts by an unauthorized person; (c) if the adjustable base has been mishandled (whether in transit or by other means), subjected to physical or electrical abuse or misuse, or otherwise operated in any manner inconsistent with the operation and maintenance procedures outlined in the Owner’s Manual and this warranty; (d) to damage to mattresses, fabric, cables, electrical cords or items supplied by dealers (contact the dealer for warranty information on these items); (e) if there has been any modification of the adjustable base without prior written consent by Bed-Tech; or (f) to costs for unnecessary service calls, including costs for in-home service calls solely for the purpose of educating You about the adjustable base or finding a satisfactory power connection.

This warranty will be void if either the recommended weight restriction is not followed which is 850 total lbs. including persons, mattresses, and bedding materials, for non-manufactured defects, or if any modifications are made to the adjustable base.

This warranty will only apply to the original purchaser and will be void to a subsequent owner.

Any repairs to or replacement to Your adjustable base or its components under the terms of this limited warranty does not extend the applicable warranty from the Warranty Commencement Date. This time limitation may not apply in some jurisdictions, including the Province of Quebec. The decision to repair or to replace defective parts under this warranty shall be made, or cause to be made, by Bed-Tech at its option and in its sole discretion.

There shall be no liability on the part of Bed-Tech for any special, indirect, incidental, or consequential damages or for any other damage, claim, or loss not expressly covered by the terms of this warranty.

This limited warranty does not include reimbursement for inconvenience, removal, installation, setup time, loss of use, shipping, or any other costs or expenses. Bed-Tech and its service technicians will not be responsible for moving furniture or any other items not attached to the adjustable base in order to perform service on the adjustable base.

It is the sole responsibility of You to provide adequate space and accessibility to the adjustable base. In the event that the technician is unable to perform service due to lack of accessibility, the service call will be billed to You and the service will have to be rescheduled.

Bed-Tech makes no other warranty whatsoever, express or implied, and all implied warranties of merchantability and fitness for a particular purpose are disclaimed by Bed-Tech and excluded from this agreement.

Some American States do not allow the exclusion or limitation of incidental or consequential damages, so the above limitation or exclusion may not apply to You. This warranty gives You specific legal rights, and You may also have other rights, which may vary from jurisdiction to jurisdiction. This warranty is valid in all 50 American states and the District of Columbia.

For customer service under this limited warranty please contact Bed-Tech by phone,

Toll free phone: 888-236-3044 (For all service)

Customer Service: 888-236-3044

All electronics and components that need to be installed are located in boxes under the foundation or attached to the frame. Before discarding the packing materials, ensure that all the parts are accounted for.

A



AAA Batteries (2)

B



Bed Legs & Bottom Caps (6)
King/CK Bed Legs & Bottom Caps(7)

C



Power Supply (1)

D



Power Cord (1)

E



Remote Control (1)

F



Retainer Bar (1)
Attached to the bed frame

OPTIONAL EQUIPMENT (NOT INCLUDED)

(2) 9-Volt Batteries



Socket and Crescent Wrench



Actual product appearance and functionality may vary from photographs.

BT6500 Electronics Quick Reference Guide



BT6500 WIRELESS OVERVIEW

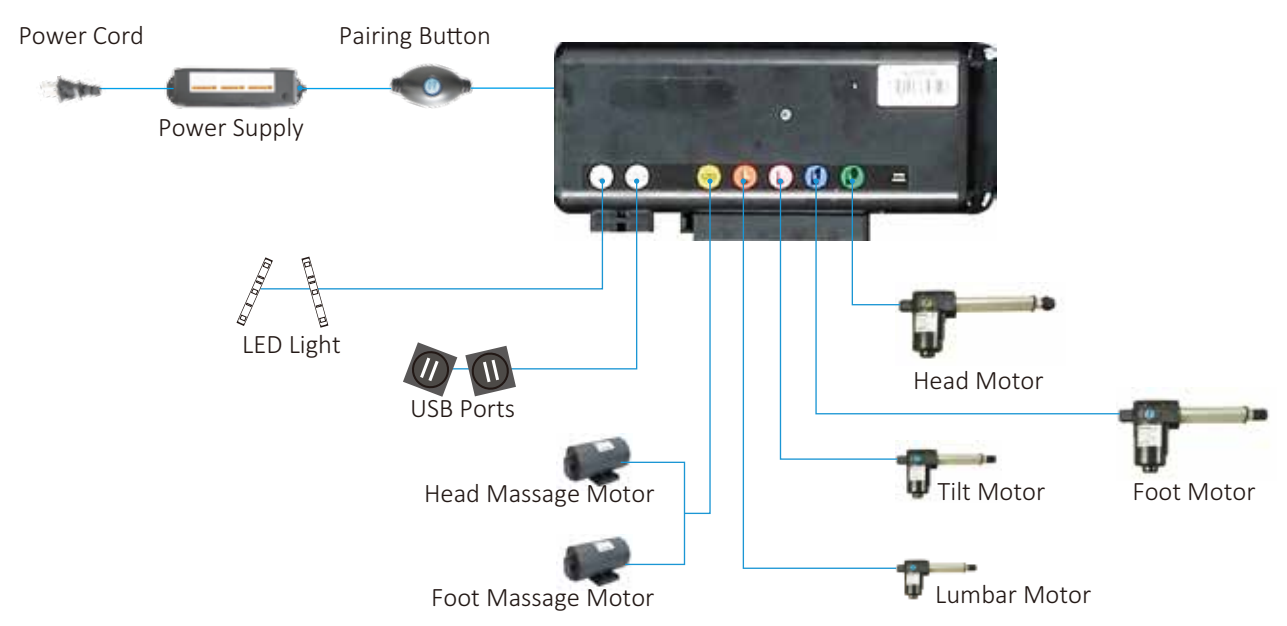
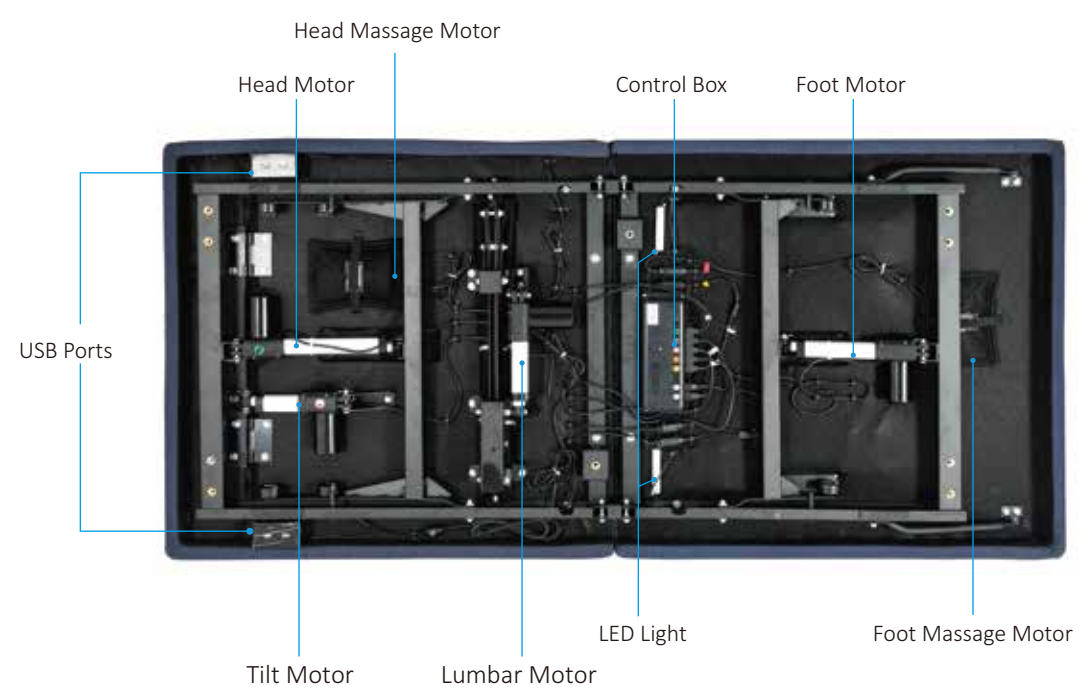

Customer Service: 888-236-3044

Two people are required to set up the foundation.

NOTE: To avoid damage to the foundation, always open the carton while the bed is in the flat position.

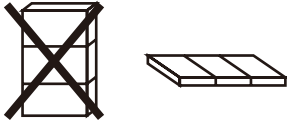

1. Open the shipping box, cut the ribbon securing accessory boxes & mattress retainer bar, and put them aside. Lift the folded bed frame unit out of the shipping carton carefully, and then put it on a flat floor.



2. To install all six legs (seven for king/CK size, see image A on the bottom right), thread the bolt of the leg to the nut on the foundation frame, and tighten by hand. **DO NOT OVERTIGHTEN.**



3. Uncoil the input power cord (connected to the control box's power port) and plug it into the power supply.



4. Uncoil the power cord and connect it to the power supply.



5. Carefully flip the foundation over onto its legs.

Important: Two people are required to move the foundation. Do not drag across the floor. Do not rest frame on its side; excessive pressure may damage the legs.

6. Ensure that batteries are correctly installed.



7. Locate the mattress retainer bar brackets.

Slide the left side of the mattress retainer bar into the bracket. Pull the retainer bar to the opposite bracket and secure the right side.



BT6500 Remote Control Instructions



BT6500

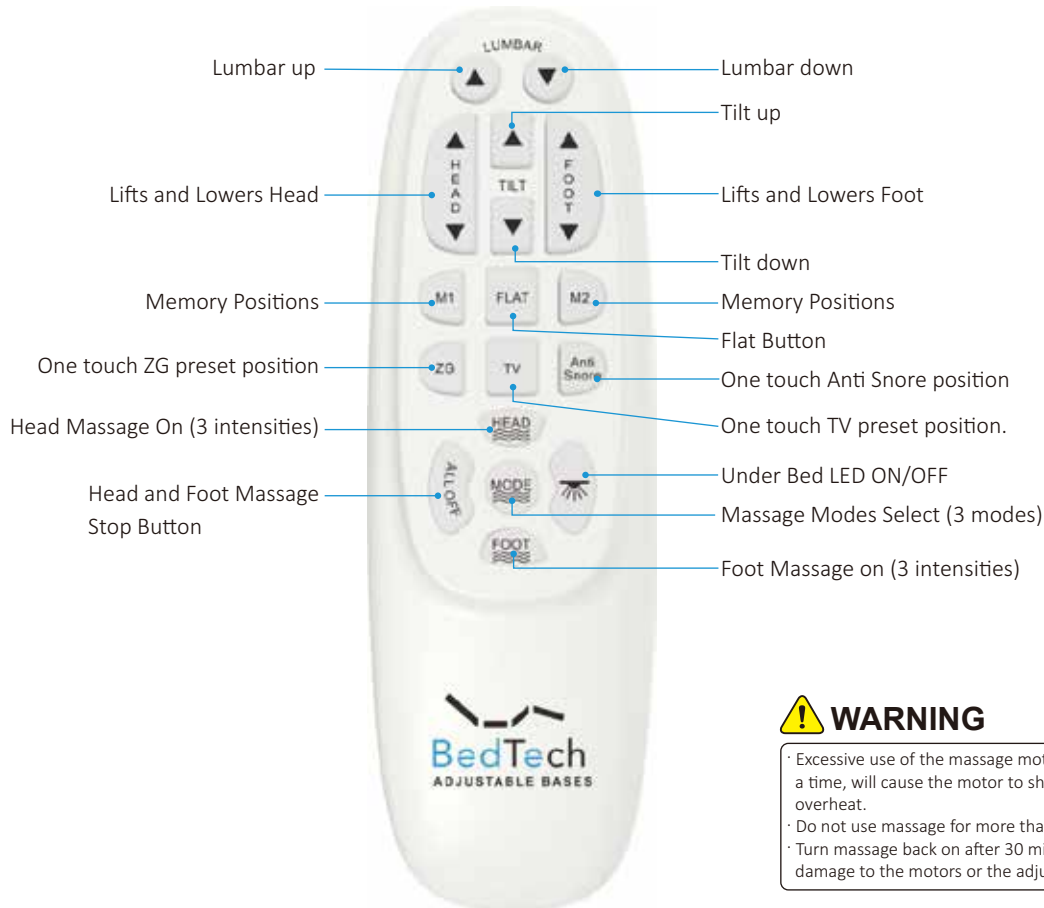

WARNING

- Excessive use of the massage motors, over 30 minutes at a time, will cause the motor to shut down and possibly overheat.
- Do not use massage for more than 30 minutes at a time.
- Turn massage back on after 30 minutes rest to prevent damage to the motors or the adjustable base.

ADJUST



The HEAD▲▼ arrows lift and lower the head section of the base.



The FOOT▲▼ arrows lift and lower the foot section of the base.



Tilt up



Tilt down



Lumbar up & down

ONE TOUCH BUTTONS



One touch TV preset position.



One touch ZG preset position.



One touch Anti Snore position



One touch FLAT preset position.



One touch programmable preset position.



One touch under bed LED light on/off.

MASSAGE FEATURE



The button will turn on the head massage. Cycle through 3 intensities.



The button will turn on the foot massage. Cycle through 3 intensities.



The button will change the massage modes. Cycle through 3 intensities.



Head and Foot Massage Stop Button

- Step 1: Plug base into power source**
- Step 2: Turn Bluetooth on in cell phone**
- Step 3: Install the app**

For IOS System

1. Go to app store as shown in picture below.
2. Type "Bedtech bed control" into search field and select app; press "install" to install app onto cell phone as shown below.
3. Successful installation shown in picture below.

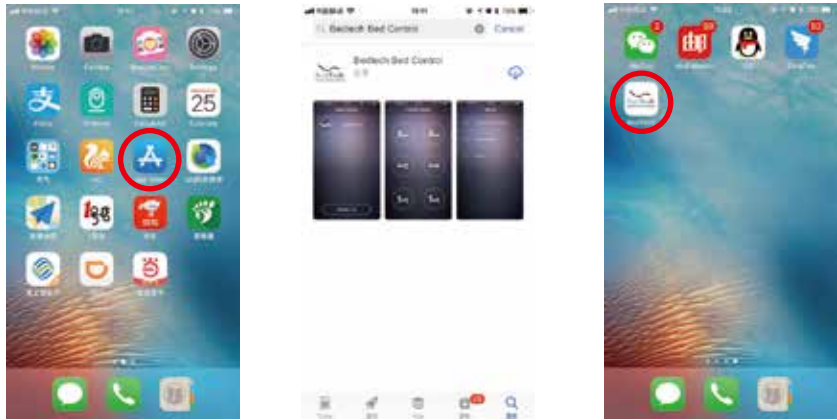

For Android System

1. Search "Bedtech bed control" in google store to install APP.
2. Successful installation shown in picture below.

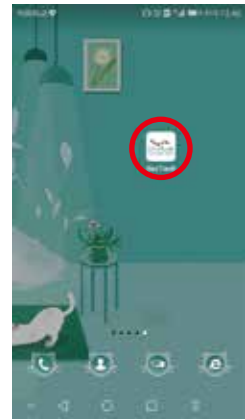

Step 4: Control device via app.

1. Open app that was previously installed on cell phone as shown in picture below.
2. Refresh list and select your device as shown in picture below.
3. Scan the QR code on the back of remote after selecting your device.

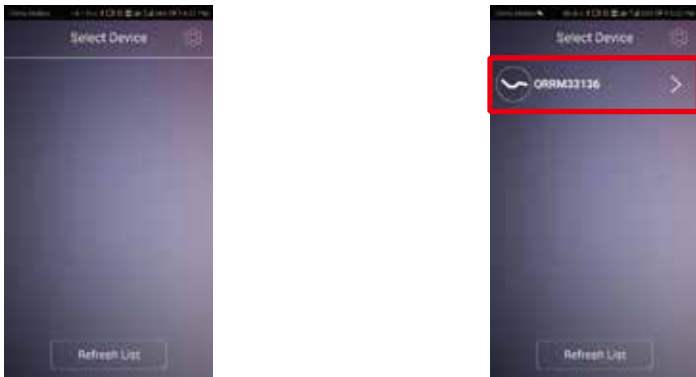

Step 5: Open control center and select desired options.



Setting Programmable Positions and Pairing Remote



SETTING PROGRAMMABLE POSITIONS



The wireless power bed has a programmable feature that allows you to save custom positions. Please read all the instructions below before setting your custom presets on the remote.

STEP 1

Adjust the head and foot to your desired position.



STEP 2

Press and hold the flat button  first, then press and hold memory button  for 5 seconds until you hear 2 beeps sound.



STEP 3

To adjust the saved position, repeat steps 1 and 2 and the new position will be saved.

PAIRING REMOTE

The original remote that comes in the box is already paired to the foundation. No further action is required. In the event that the remote is not paired with the foundation, follow the steps below.

STEP 1

Make sure the batteries work fine. Replace them when needed.



STEP 2

Plug the power cord to the power source.



STEP 3

Press and hold head lift and foot lift simultaneously, then press and hold the button on the cord of control box for 3 seconds until you hear 2 beeps sound, the remote is then paired.



Customer Service: 888-236-3044

SYNCHRONIZING TWO BASES

STEP 1

Plug A and B bases to power source.

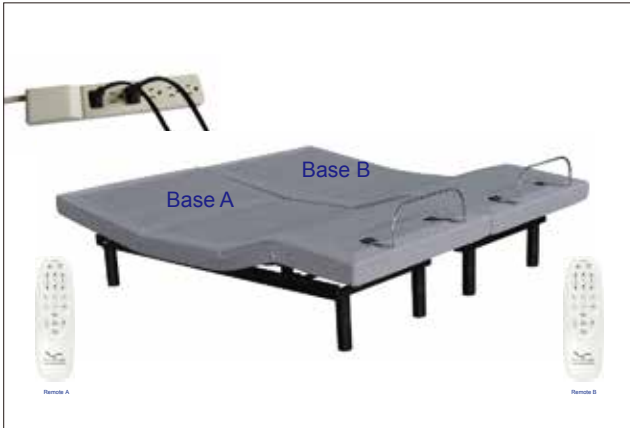

STEP 2

Make sure remote A was already paired to Base A and Remote B was paired to Base B. If not, please pair them by following the pairing remote instructions on page 08.

STEP 3

Pair remote A to Base B, then base A and base B can be simultaneous operated by Remote A.



STEP 4

Press and hold head down and foot down buttons on remote B, at the same time (simultaneously) press and hold head up and foot up buttons on Remote A, the learning process is successful when the flashlight on remote B starts to flash. Now both remotes will be able to operate both beds simultaneously.

Note: If you want to operate the beds separately, press and hold  and  beside Tilt on remote B; then the flash light will be on, and the remote B has been separated from the remote A.

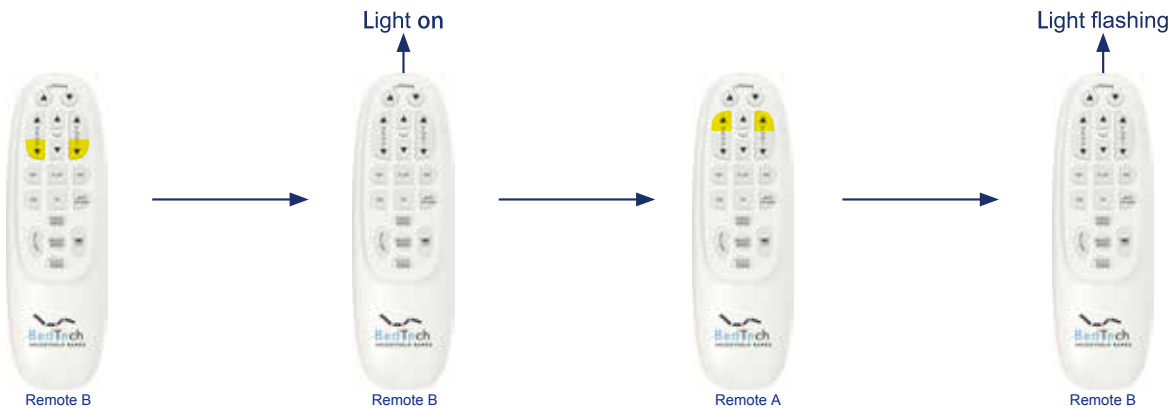

Headboard Bracket Installation Guide



Headboard brackets are an optional accessory and are not included.
A 1/2" (13 mm) socket and 1/2" (13 mm) crescent wrench are necessary to complete installation.

HEADBOARD BRACKET COMPONENTS

(2) Headboard Brackets	(2) T-Brackets	(4) Short Bolts	(12) Nuts	(8) Long Bolts
				

STEP 1

The headboard bracket will have 2 long slots to accommodate any frame type. Align the appropriate slots on the bracket with the holes on the bed. Use long bolts and nuts to secure the bracket. Make sure the bolts are tight.



STEP 2

To put the T-Bracket and Headboard Bracket together, you will need (2) short bolts and (2) nuts. Slip the bolts through the holes from T-Bracket to Headboard Bracket with the head of bolt facing outward. Use 1/2" (13mm) socket and 1/2" (13mm) wrench to tighten the bolts.



STEP 3

You may now connect your headboard to the attachment plates using the remaining short bolts and nuts to secure it to the brackets. The heads of the bolts will face outward. Use a 1/2" (13 mm) socket and 1/2" (13 mm) wrench to tighten the bolts.

In the event that the power foundation fails to operate, assess the symptoms and possible solutions provided in the chart below.

SYMPTOMS	SOLUTIONS
Remote control illuminates and appears to be operable, but will not activate bed.	Verify that the power cord is plugged into a working, grounded electrical outlet. Test the outlet by plugging in another working appliance.
No features of the power foundation will activate.	<p>Program the remote control (see the Setting Programmable Positions and Pairing Remote section of this manual for programming procedures).</p> <p>Unplug the power cord, wait 30 seconds and plug back to reset electronic components.</p> <p>The surge protection device or the electrical outlet may be defective. Test the outlet by plugging in another working appliance.</p> <p>Verify that the connector on the wired remote control is securely attached to the control box.</p>
Wireless remote will not illuminate.	Replace the batteries in the wireless remote.
Head or foot section will elevate, but will not return to the horizontal (flat) position.	<p>Bed mechanism may be obstructed. Elevate bed and check for obstruction. Remove obstruction.</p> <p>Head section may be too close to the wall.</p> <p>Headboard may be too close to the edge of the mattress. Verify that there is enough distance between the headboard brackets and mattress. Adjust if required.</p>

In the event that the power foundation fails to operate, assess the symptoms and possible solutions provided in the chart below.

SYMPTOMS	SOLUTIONS
<p>Head & Foot lift function has minor interference during operation.</p>	<p>Check batteries in wireless remote control, replace with two (2) new AAA batteries if necessary.</p> <p>Make sure that you are following the duty cycle of the motors (do not operate more than two minutes over a 18-minute period, or approximately 10% duty cycle).</p> <p>Press the lift buttons squarely and accurately.</p> <p>Wireless remote control may be experiencing common Radio Frequency Interference from other radio transmitting devices. Wait several seconds, and then try pressing appropriate button again, See FCC Compliance Statement on page 1 of this guide.</p>
<p>Excessive massage motor noise.</p>	<p>If the bed is located on hard surface flooring, place carpet pieces or rubber pieces (not included) under each leg.</p> <p>Using the wireless remote control, elevate the head, foot or neck section a short distance to realign the lift/lower mechanisms with the bed support platform.</p> <p>Verify that your BedTech Power Foundation is not positioned against a wall, nightstand, or other object that may cause the vibration or noise.</p> <p>If the BedTech Power Foundation is installed over a bed frame, verify that the massage motors are not causing the bed frame (or bed frame components) to vibrate.</p> <p>Verify that the headboard attachment hardware is properly tightened (if used).</p>
<p>A clicking noise is heard under the bed when raising or lowering.</p>	<p>This is normal. The lift motor relays "click" when they are engaged. No action is required.</p>
<p>Massage motor overheats or stops.</p>	<p>If the vibration motor overheats, the thermal protection will turn the motor off. Wait 30 minutes, turn the massage back on. If it does not come on, turn it off and report the situation to customer service.</p>



BedTech

ADJUSTABLE BASES

Customer Service: 888-236-3044