

MILESEEY®

SPACE™
master

D9 PRO



User's Guide

SPACE™
master

Safety Instructions

Please carefully read and adhere to all the instructions provided below. Failure to do so could potentially lead to dangerous radiation exposure, electric shock, fire, or serious injury.



WARNING

1. Be cautious of inaccurate measurements in case the instrument is faulty, has been dropped, misused, or modified. Perform regular test measurements, especially after the instrument has been exposed to unusual conditions, and before, during, and after important measurements.
2. Any alterations or adjustments not explicitly approved may result in the user losing their authority to operate the equipment.
3. The device conforms to the most stringent requirements of the relevant standards and regulations. However, the possibility of causing interference in other devices cannot be totally excluded.

Laser Class 2 products:

Using optical aids such as binoculars or telescopes to look directly into the laser beam can pose a risk to your eyes. Avoid staring into the laser beam or directing it towards others without a valid reason, as it may harm your eyes.

Laser classification:

The device produces visible laser beams, which are emitted from the instrument: It is a Class 2 laser product in accordance with: • IEC60825-1 : 2014 radiation safety of laser products.



CAUTION

Never attempt to repair the product yourself. In case of damage, contact a local dealer or the manufacture, or you may lose the right of guaranteed product warranty.

Do not throw flat batteries in your household waste. Please be environmentally responsible and take them to designated collection points in compliance with your national or local regulations.

Similarly, do not discard the product with household waste. Dispose of the product properly, following the current national regulations in your country. Always adhere to the specific regulations in your region.



Magnets may temporarily affect the normal operation of implanted electronic medical devices, such as pacemakers and implantable defibrillators. Magnets that are a part of this product can damage magnetic media such as floppy disks, hard drives, credit cards, cassette tapes, video tapes or other such devices. They can also damage televisions, computers, cell phones, VCRs, computer monitors and other CRT displays.

Prohibited Use

- Operating the product without following instructions
- Using it beyond the specified limits
- Disabling safety systems and removing warning labels
- Attempting to open the equipment using tools (such as screwdrivers)
- Making alterations or modifications to the product
- Using accessories from different manufacturers without explicit approval
- Intentionally causing glare for others, even in low-light conditions
- Not providing adequate safety measures at the surveying site, such as when measuring on roads or construction sites
 - Engaging in deliberate or irresponsible behavior while on scaffolding, using ladders, or working near operating machinery or unprotected machine parts
 - Pointing the device directly at the sun.
 - Avoid using the product in the vicinity of gas stations, chemical facilities, areas with potentially explosive atmospheres, or areas undergoing blasting activities.
 - Refrain from using the product near medical equipment.
 - Do not operate the product on airplanes.
 - Additionally, avoid prolonged use of the product near your body.

Battery Charging.

Always supervise children when they are using, cleaning, or performing maintenance on the product. This ensures that children do not play with the charger.

Prior to each use, carefully inspect the battery charger, cable, and plug for any signs of damage. If any damage is detected, refrain from using the battery charger. Damaged battery chargers, cables, and plugs greatly elevate the risk of an electric shock.

Overview

The Mileseey D9 PRO laser distance measure is an impressive measuring device with a range of up to 330ft. Its smooth and uniform appearance showcases a sleek design. Featuring a one-button design, it allows for easy and efficient measurements. With horizontal laser levels on both sides, the D9 PRO enables easy alignment and precise measurement. It also supports LED lighting, link data transmission to paired APP for optimal measuring convenience, and a magnetic bite allows the device to securely attach to metal surfaces.

Exterior features

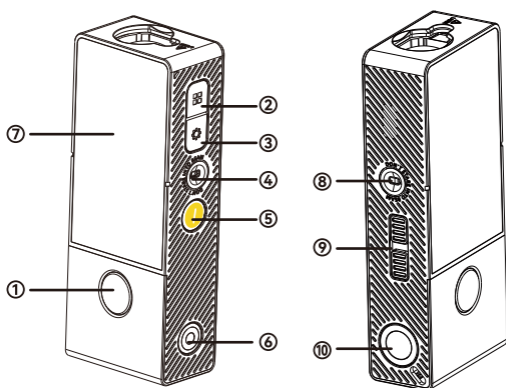

1. Measuring button

(In the setup state: a short press switches the substates)

2. Measuring functions/plus

3. Setting/minus

4. Right laser level

5. Power button/return

6. LED light switch

7. Touch screen

8. Left laser level

9. Type-C charging port

10. LED light

Note: The unique 90 LM LED spotlight of the laser measure provides a strong and focused illumination, enhancing visibility in low-light conditions, aiding in accurate measuring by illuminating the target area, and reducing errors.

Touch Screen

1. Upon startup, Swipe the screen from left to right to enter measuring functions. Swipe from right to left to return. Slide up and down to navigate to the desired function. Tap the function icon to enter the desired measuring mode. Once in the measuring mode, swipe from left to right to return to upper level menu, and slide from right to left to enter the measuring mode again.

2. Upon startup, slide from up to down to enter the setting menu, and slide from down to up to return. Tap the setting icon to switch between different setting's sub-states or enter a setting.



Magnetic Bite

The magnetic bite allows the device to securely attach to metal surfaces, such beams or pipes, without the need for additional support or holding, keeping it within reach and readily available whenever needed.

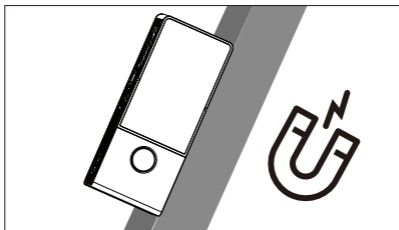

Calibration of Point-to-Point(P2P) measurement

Before using the P2P (Point to Point) function, swipe the touchscreen to enter the P2P measurement feature interface. Place the device horizontally on a level surface, then lightly tap the P2P measurement icon. The P2P measurement will automatically calibrate using algorithms. The interface will display a message indicating that calibration is in progress, and the entire calibration process will last for 6 seconds.



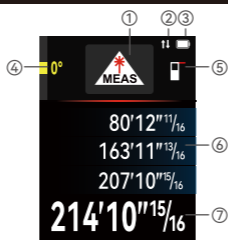

Display Elements



1. Measuring mode
2. Link connected
3. Battery indicator
4. Display gravity tilt angle
5. Measurement reference
6. Measured-value lines
7. Result line

References

There are in total four references for the device:

-  Distance is measured from the rear of the device (standard setting).
-  Distance is measured from the laser level.
-  Distance is measured from the front of the device.
-  Distance is measured from the tripod thread permanently.

To select the target reference point, tap the reference icon on the display to access the reference setting interface. Next, tap the representation of the device's target position on the screen to switch to your preferred reference point. To exit the reference setting, tap the reference icon again.

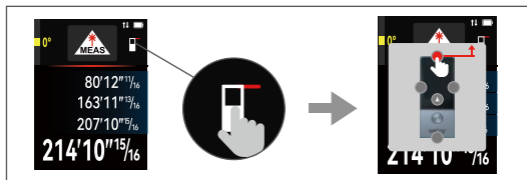

Note: The dual laser level will subsequently turn on when the reference is switched to laser level reference.

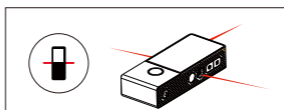

360° digital level

The 360° digital level display is used to measure the flatness of a horizontal surface, or measure the angle of a particular tilted surface. When you access the flatness detection by entering the flatness detection interface, a light blue bar will appear, showing a 0-degree reading if a level horizontal surface is detected.

Tap the digital level icon on the screen on the left side of the screen, it'll directly enter the 360° digital level display.

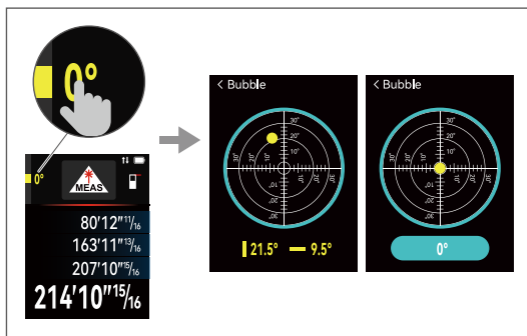

Product Settings

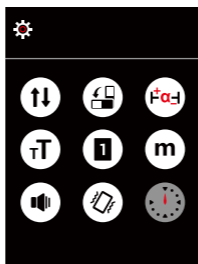

Link	Unit
Screen rotation	Sound
Constant/Offset setting	Measuring vibration
Big text	Timed measuring
White/black screen background	

1. Link connection:

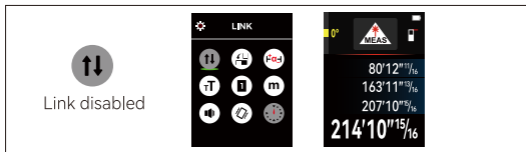
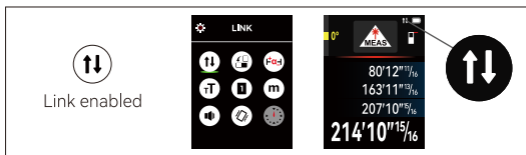

The measuring device:

After turning on the device, enter the settings, switch to link settings (⬆️⬆️). The flashing icon (⬆️⬆️) means that the link is not connected, and the fixed display means that the link connection is successful.

The mobile device:

Turn on the link of the mobile phone; Click the link connection in the APP. After the connection is successful, the link icon turns blue, and the link icon on the measuring device no longer flashes. At this time, the user can perform functions such as data transmission and data labeling through the APP. The link function needs to be used in conjunction with the mobile phone APP, and the user needs to download the "Smart Life" APP in advance.

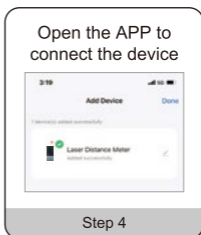
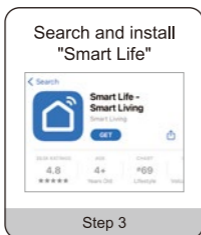
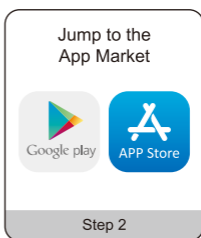





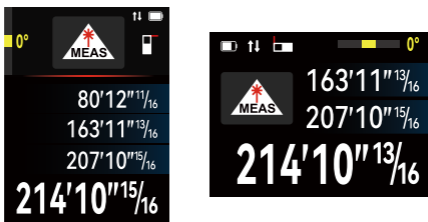

2. Screen rotation:

Choose to enable or disable the automatic screen rotation which offers both portrait display and landscape display.



3. Constant/Offset setting:

The offset setting is an important feature in a laser measure that allows users to compensate for systematic errors caused by known environmental or other factors, ensuring more accurate measurement results.

To access the off set setting, short press the "Set" button  and enter the system setting menu interface. Use the plus and minus buttons   to navigate to the "Offset Setting  " option. Then, press "measure" button  to enter the setting interface and set the value accordingly. Use "function" button  to move the digit position, and use the "set" button  to set the value. The final measurement result will display the actual distance by adding or subtracting the set offset value.

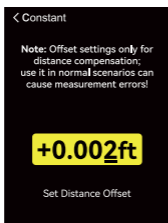



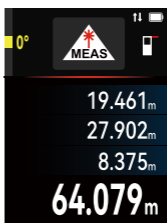
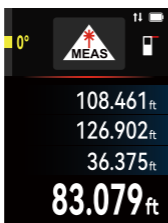

4. Unit:

Switch between 6 different units: m, cm, mm, ft, in, ””





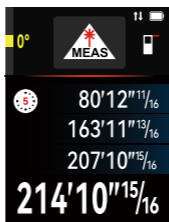

5. Time-delayed measurement:

Short-press the "Set" button  to access the system setting menu interface. Use the plus and minus buttons   to navigate to the delayed measurement option. Short-press "measure" button  to enter the delayed measurement mode. After a countdown of 5 seconds, the measurement result will be displayed. You can opt for a 3-second or 5-second delay, or turn the feature off entirely.

After a countdown of selected time, the measurement result will be displayed. Please note that the delayed measurement feature can be applied to all the measuring modes.





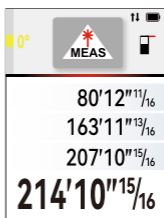
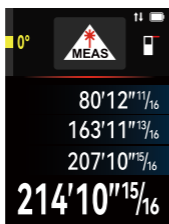

6. White/black screen background:

Short press the "Set" button  to access the system setting menu interface. Use the plus and minus buttons   to navigate to the black and white screen switch option. Short-press the "measure" button  to make a selection. Once selected, press the "power" button  briefly to exit the settings. (Please note that White/black screen background feature can be applied to all the measuring modes.)







7. Big Text mode

The Big Text mode offers more intuitive data reading. Short-press the "Set" button  to access the system setting menu interface. Use the plus and minus buttons   to navigate to the Big Text mode option. Short-press the "measure" button  to select either enable or disable. A white icon indicates that it is enabled, while a black icon indicates that it is disabled. Once selected, short press the "power" button  to exit the settings.







8. Sound on/off

Short press the "Set" button  to access the system menu interface. Use the plus and minus buttons   to navigate to the sound option. Short Press the "measure" button  to toggle between on, off . Once selected, press the "power"  button briefly to exit the settings.



9. Vibration confirmation

Short press the "Set" button  to access the system menu interface. Use the plus and minus buttons   to navigate to the Vibration confirmation. Short Press the "measure" button  to select either enable or disable the function. A white icon indicates that it is enabled, while a black icon indicates that it is disabled. Once selected, press the "power" button  briefly to exit the settings.

A vibration will be emitted once a distance value is acquired.



Vibration on



Vibration off

Note: All the setting menu and sub-setting menu can be alternatively accessed by sliding the screen and tapping the target icon of the setting options. Settings of enabling, disabling and switching to a particular state can also be achieved alternatively by tapping the icon.

Auto-screen rotation achieved by tapping the screen



Memory & Add/Subtract

Access the memory and the add/subtract functions by swiping from right to left on the screen. To activate these functions, simply tap their corresponding icons on the display.

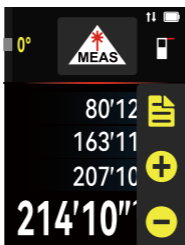

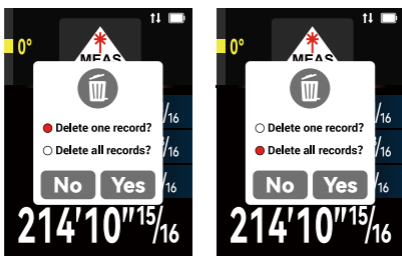

Memory

To access and review your memory data, tap the "Memory" icon  to open the memory record interface. You can then navigate through the records by swiping or using the quick-access buttons located on the right side of the device. If you need to delete any data, simply perform a long press on the screen. This action will prompt a message to appear, providing options to delete the current data or all stored data.



Add/Subtract

Initiate the measurement process by engaging the measurement functions. Press the function icon or the physical measure button to capture the initial result. Then, hit the "Add/Subtract" icon (/). Then take the next measurement, and the device will automatically perform the chosen operation—adding or subtracting the next measurement from the previous ones. The display will then show the definitive total if adding, or the remainder if subtracting, as the final result.

Measuring Functions

Note: The measurement can be triggered either by depressing the physical measurement button or alternatively tapping the function icons on the screen.

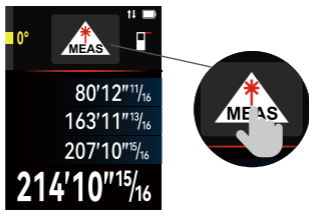

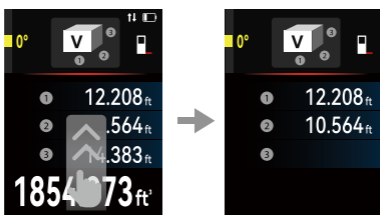

Result correction:

If you experience an error following a length measurement, you can clear the result by sliding from the bottom result line and moving upwards. After clearing the target data, you can proceed to remeasure the distance.



1. Length measurement

Length Measurement Select the length measurement  . To switch on the laser beam, briefly press the measuring button  .

To take a measurement, briefly press the measuring button  . The result will appear at the bottom of the display.

For each additional measurement, simply follow the same steps mentioned above. The most recent measurement will be displayed at the bottom, the one before it above that, and so forth.

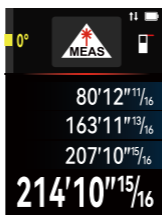



2. Continuous measurement

To conduct continuous measurements, you can move the measuring tool in relation to the target. This will result in the measuring value being updated approximately every 0.5 seconds. This allows you to, for instance, move a specific distance away from a wall while always having the current distance readily available for reading.

Select the continuous measurement  .

To switch on the laser beam, briefly press the measuring button  .

Then, move the measuring tool until you see the desired distance value displayed at the bottom of the screen. If you briefly press the measuring button  again, it will pause the continuous measurement, displaying the current measurement at the bottom, with the maximum and minimum values above it. To resume continuous measurement, press the measuring button  once more.

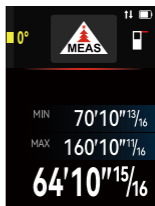
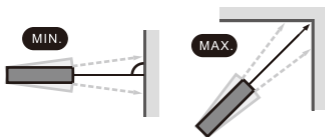

3. Live angle display

The live angle display allows you to acquire a desired angle or measure an existing angle on any surface and gives you real time confirmation of the angle in your angle measurement.

To use this function, first tap the live angle display icon  to access its interface. Tap the icon once more to calibrate the angle value to zero. Then use the aligning laser line as your starting point and move the device from that initial line, the D9 Pro will accurately display the real-time live angle formed between the current aligning laser line and the original one on any surface.

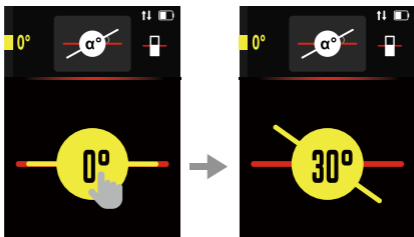

4. Point-to-point measurement

Select the Point-to-point measurement . Measure distances "1," "2," in this sequence using standard length measurements. Ensure that the measurement of distance "2" begins precisely at the endpoint of distance "1". After completing the final measurement, the result for the desired distance L will be shown in the result line. The individual measured values will be displayed in the measured-value lines.

Using the Trimotion360TM adaptor.

The Trimotion360TM adaptor allows for stable targeting without unintentionally tilting the device.

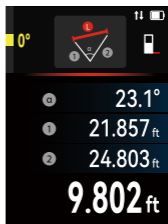
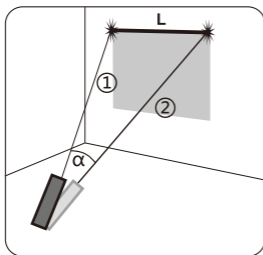

5. Area measurement

Select the area measurement . Next, proceed to measure the width and length consecutively, just as you would with a single length measurement. The laser beam will stay active during both measurements. The distance to be measured for calculating the area will flash in the indicator specifically designated for area measurement. The first measurement value is displayed at the top of the screen.

Once the second measurement is done, the device will automatically calculate and display the area. The final result will appear at the bottom of the display, with the individual measured values displayed above it.

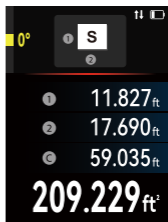
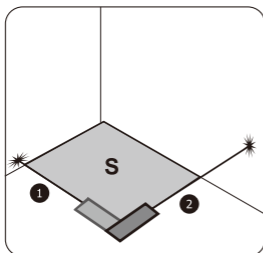

6. Volume measurement

Select the volume measurement .

Now, proceed to measure the width, length, and depth consecutively, just as you would with a single length measurement. The laser beam will stay active throughout all three measurements. The distance to be measured for volume calculation will flash in the indicator specifically designated for volume measurement.

The first measurement value is displayed at the top of the screen.

Once the third measurement is finished, the device will automatically calculate and display the volume. The final result will be shown at the bottom of the display, with the individual measured values displayed above it.

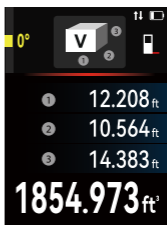
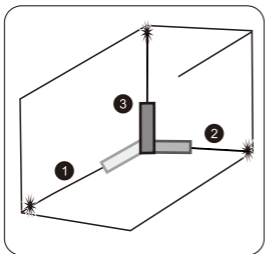

7. Auto horizontal distance

Select Auto horizontal distance measurement .

The distance you want to measure will flash in the indicator. Ensure that the measuring tool is positioned at the same height as the desired measuring point. Then, tilt the measuring tool around the reference plane and measure the length of hypotenuse 1, similar to a standard length measurement. After completing the measurement, the result for the desired horizontal distance will appear in the result line. The measured values for distance "1" and angle "" will be displayed in the measured-value lines.

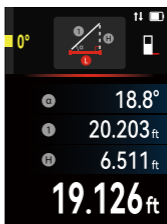
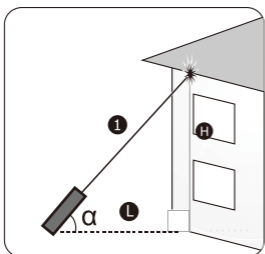

8. Auto vertical height

Select auto vertical height measurement .

Measure the distances of hypotenuses "1" and "2" in the same manner as you would for a standard length measurement. Once the measurement process is complete, the result for the desired vertical height will be shown in the result line. The measured values for distances "1," "2," and the angle "α" will be displayed in the measured-value lines.

Please ensure that the reference plane of the measuring tool, remains consistently positioned in the same place throughout each measurement within a measuring sequence.

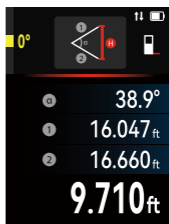
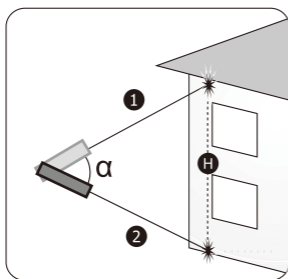

9. Trapezium measurement

Select the Trapezium measurement .

Measure distances "1," "2," in this sequence using standard length measurements. Ensure that the measurement of distance "2" begins precisely at the endpoint of distance "1". After completing the final measurement, the result for the desired distance L will be shown in the result line. The individual measured values will be displayed in the measured-value lines.

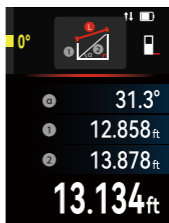
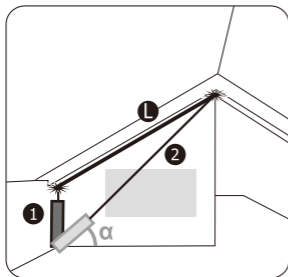

10. Wall area measurement

Select the wall area measurement .

The wall area measurement is used to determine the sum of several individual surfaces with a common height.

Begin by measuring the ceiling height "H" using the same procedure as a standard length measurement. The measured value will appear in the top measured-value line, and the laser will remain active.

Following that, measure the length "L1" of the first wall. The surface area will be automatically calculated and displayed in the result line. The most recent length measurement value will be shown in the bottom measured-value line, and the laser will continue to be active.

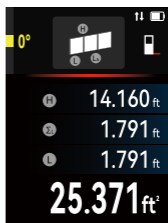
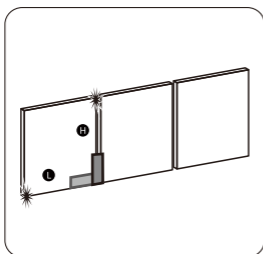

11. Triangular area

Select the triangular area measurement .

The distance you want to measure will flash in the indicator.

Measure the distances of triangular segment "1", "2" and "3" in the same manner as you would for a standard length measurement.

After completing the final measurement, the result for the triangular area will be shown in the result line. The individual measured values will be displayed in the measured-value lines. In the triangle area measurement mode, please make sure that the three line segments form a closed triangle and that all three line segments are in the same plane; otherwise, the screen will display error.

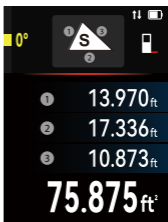
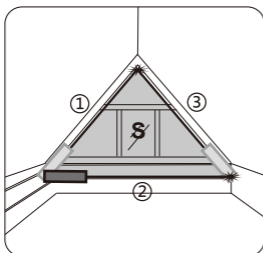

12. Circular area

Select the circular area measurement **S**.

The distance you want to measure will flash in the indicator. Before measuring the area of a circle, locate the center of the circle. Then, activate the laser and, following the guidance of the flashing line segments, pass the laser beam through the center of the circle. The area of the circle will be automatically calculated and displayed at result line. The diameter and circumference of the circle will be shown in the measured-value lines.

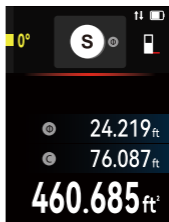
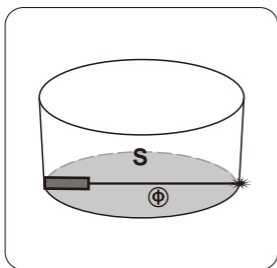

13. Cylinder volume



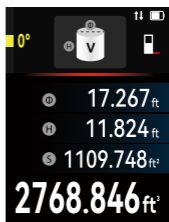
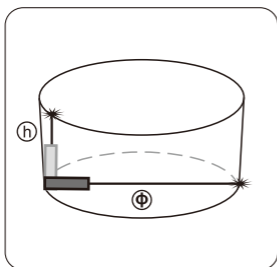

Select the cylinder volume measurement **V**.

The distance you want to measure will flash in the indicator. Before measuring the area of a circle, locate the center of the circle. Then, activate the laser and, following the guidance of the flashing line segments, pass the laser beam through the center of the circle. Measure the diameter of the circle, and then, guided by the flashing line segments, measure the height of the cylinder H. The volume of the cylinder will be automatically calculated and displayed at the result line. The diameter, area of the circle and the height of the cylinder will be shown in the measured-value lines.



14. Stake-out

Select the stake-out function  .

Tap the box A of beginning value, set the beginning value by using function button  to move the digit position and determining a value with “set” button  , and then tap the box B to set the desired stake-out length. Using function button  selects the corresponding digit/position and change the value with “set” button  .

Begin the stakeout function by pressing the measuring button  and slowly move away from the starting point.

The measuring tool continuously measures the distance to the starting point. The defined length and the current measured value are thereby displayed. The lower or upper arrow displays the shortest distance to the next or last marking. When approaching to a timed distance to the defined stake-out distance, the device starts buzzing.

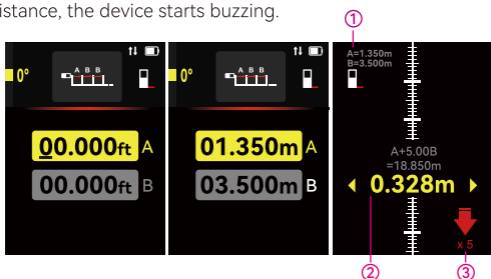

1. A: The beginning distance: 1.350m
B: The defined length: 3.500m
2. The difference(the distance left to the stake out point)
3. Times: N
4. Total length= $1.305+N*3.5000$

Specification:

Range	0.5~330ft(0.2~100m)
Accuracy	$\pm(2.0\text{mm}+5*10^{-5}D)$
Single distance	√
Continuous measurement	√
Angle measurement	√, Rotating & Pitching Angle
Point-to-point measurement(P2P)	√
Area	√
Volume	√
Auto horizontal distance	√

Auto vertical height	√
Trapezium	√
Wall area	√
Triangular area	√
Circular area	√
Cylinder volume	√
Stake-out	√
Link & APP connectivity	√
Units	m, cm, mm, ft, in, ' "
References	Front/rear/tripod center/ laser level
Touch screen	2.4" IPS
Auto screen rotation	√
Memory	35 groups
Constant/offset setting	√
Timed measurement	3s, 5s, off
White/black screen background	√
Big text mode	√
Sound	On/off
Vibration	√
Digital level	√
Auto power off	After 180s of inactivity
Auto laser switch off	After 30s of inactivity
Laser class	Class II
Laser type	630-670nm, <1mw
Aligning laser	√, 630-670nm, <1mw
Operating temperature	0°C ~ 40°C
Battery type	1800mAH rechargeable Li-ion battery
Battery runtime	8H(without flashlight & aligning lasers on)
Output interface	Type-C
Dimensions	118mm*48.5mm*24.5mm
Net weight	170g

Error Code

All errors or failures will be shown as codes. The following table explains the meaning of codes and solutions.

Code	Cause	Corrective Measure
204	Calculation error	Refer to user manual; repeat the procedures.
208	Excessive current	Please contact your distributor
220	Low battery	Replace batteries or charge the batteries.
255	Received signal too weak or measuring time too long	Change target surface
256	Received signal too strong	Change target surface
261	Out of the range of measurement	Select the measurement distance within the range of measurement.
500	Hardware error	Switch on/off the device several times. If the symbol still appears, please contact your dealer for assistance.

Copyrights

The product specifications are subject to change without notice. All final interpretation rights are reserved by Mileseey Technology Co., Ltd., and all trademarks, product images, technical parameters are properties of Mileseey Technology Co., Ltd., and all rights reserved.

Contact Us

Mileseey technology(US) Inc.

Office Add: 2995 East Sunset Rd Unit d115 Las Vegas NV 89120

Website: www.mileseey.net

Store: www.mileseeytools.com

E-mail: service@mileseey.com

Made in China

Mileseey has started researching, developing and manufacturing of high-quality optical products including laser measure, laser level, golf rangefinders, thermal and digital night vision monocular & goggles since 2009.

Having focused on the development, researching, and manufacturing for over 15 years, we strive to provide premium products and best customer services to make people's life easier and smarter.

Warranty

30-Day return and refund guarantee, 12-Month warranty, lifetime technique support by MILESEEY.

Please feel free to reach us with any concerns.

Email: service@mileseey.com

We strive to reply to you within 24hours.



Mileseey technology(US) Inc.

Add: Office Add:2995 East Sunset Rd Unit d115 Las Vegas NV 89120

Website: www.mileseey.net

Store: www.mileseeytools.com

E-mail: service@mileseey.com

Made in China

R-R-MLY-DP20-PRO

