

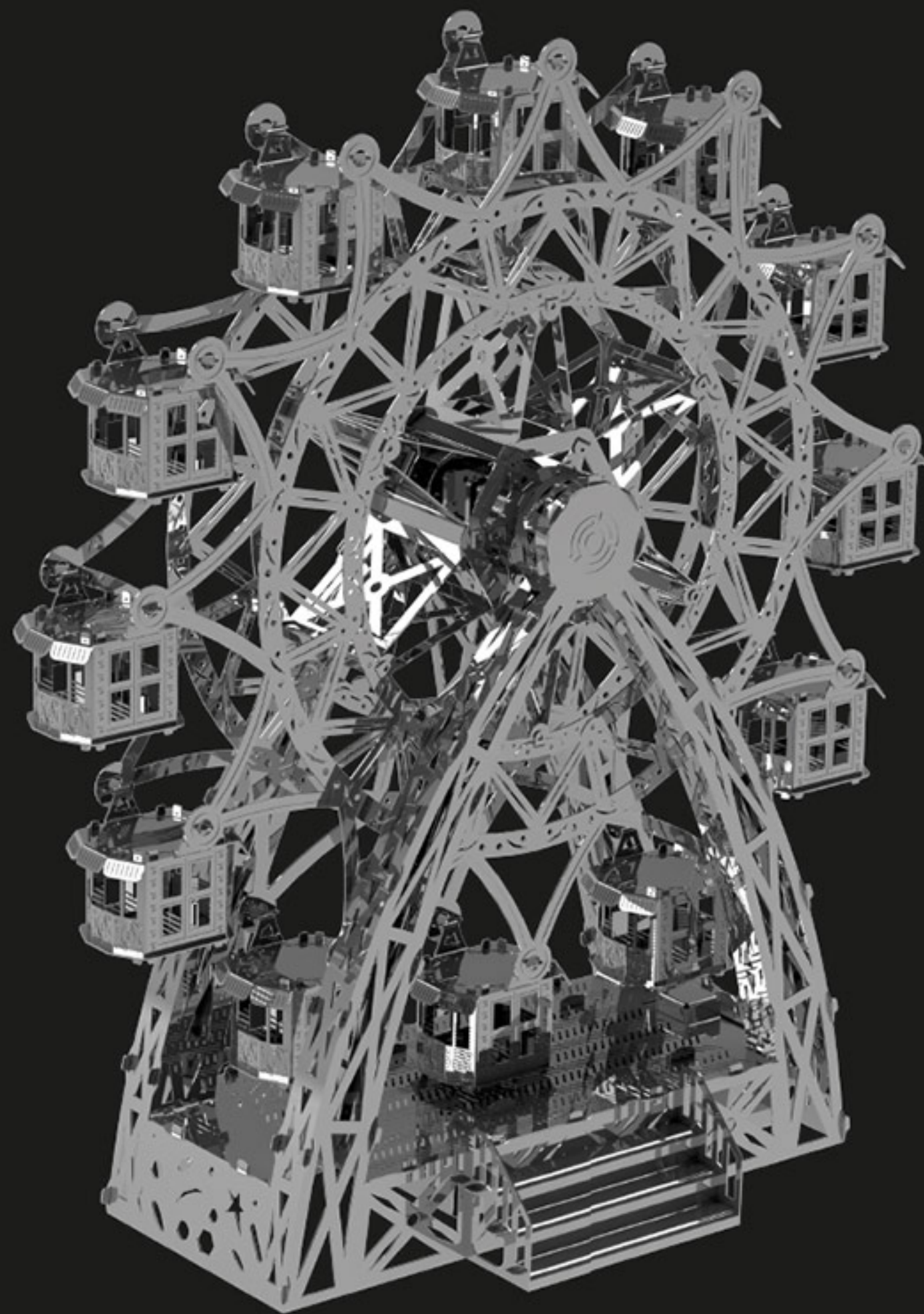

METAL<sup>®</sup>  
TIME

# AMUSEMENT RIDE

3D Metal Mechanical  
Model Building Kit



Assembly instructions  
Інструкція зі складання  
Instrukcja montażu  
Istruzioni di montaggio  
Montageanleitung  
Instructions de montage  
Instrucciones de montaje  
Instruções de montagem  
Інструкція по сборке  
装配说明书  
조립 설명서  
組立説明書

تعليمات التجميع  
הוראות הרכבה

Collect the Best

63 pieces

6 hours

Art decore / VIP cabin / Metal craft  
3V motor source

AGES  
14+



## STANDARD FIXING OF FASTENERS AND SYMBOLS

When assembling the model, don't rush, avoid pointing details at yours or anyone else's face. If one of the parts has a sharp edge, please file it down. Use pliers and additional tools to assemble the model. Each kit contains a cloth for wiping and polishing the model once it's assembled.

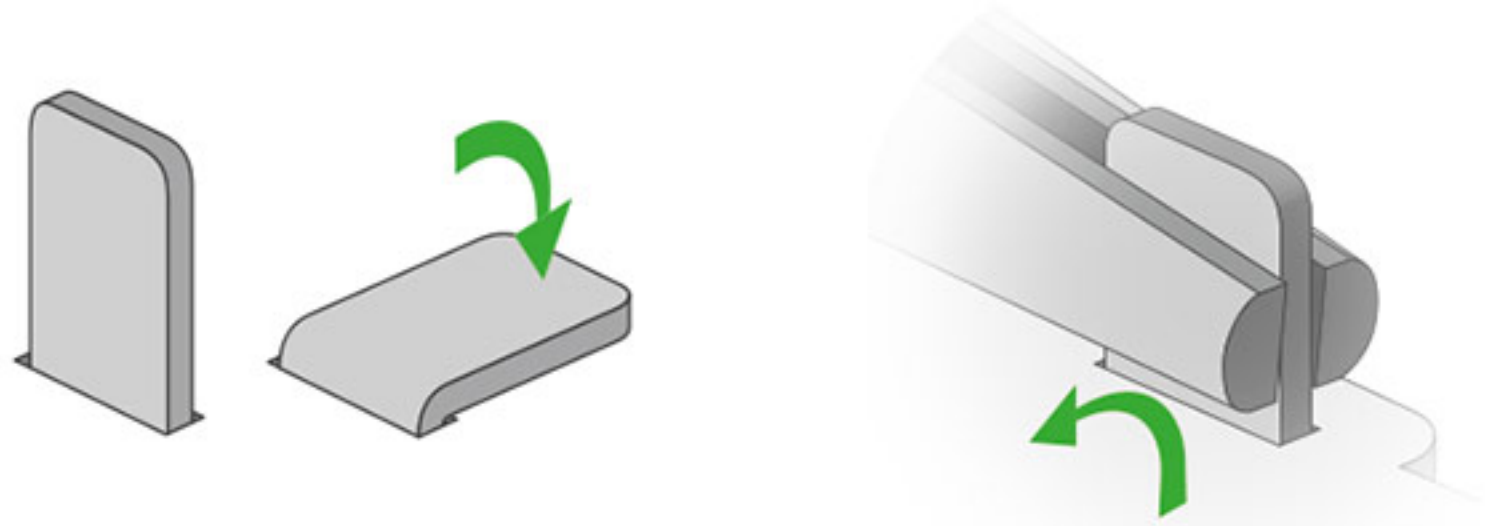

If there are no additional designations, use the standard fixing method. Use pliers to bend the fasteners.

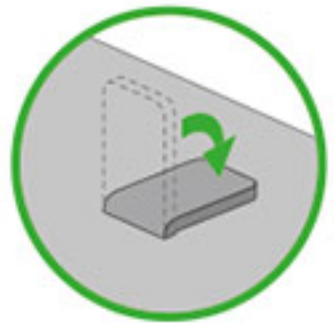

Bend the eyelet 90°

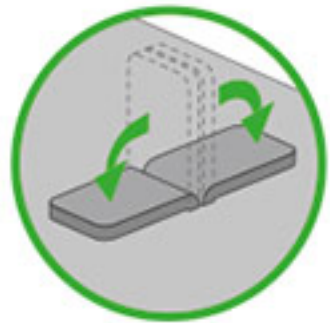

Bend the ears 90°



Assemble the parts symmetrically



Twist the eyelet 45°

**WARNING!** Product contains small parts and sharp parts. Not suitable for children under 3 years of age. Please read these instructions carefully before assembly and use.

## MODEL PARTS AND ASSEMBLY TOOLS

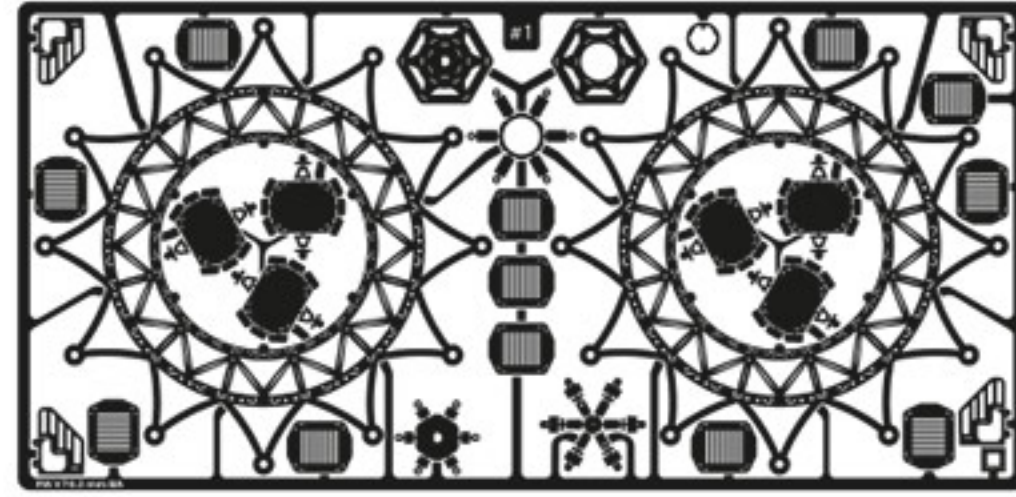

#1

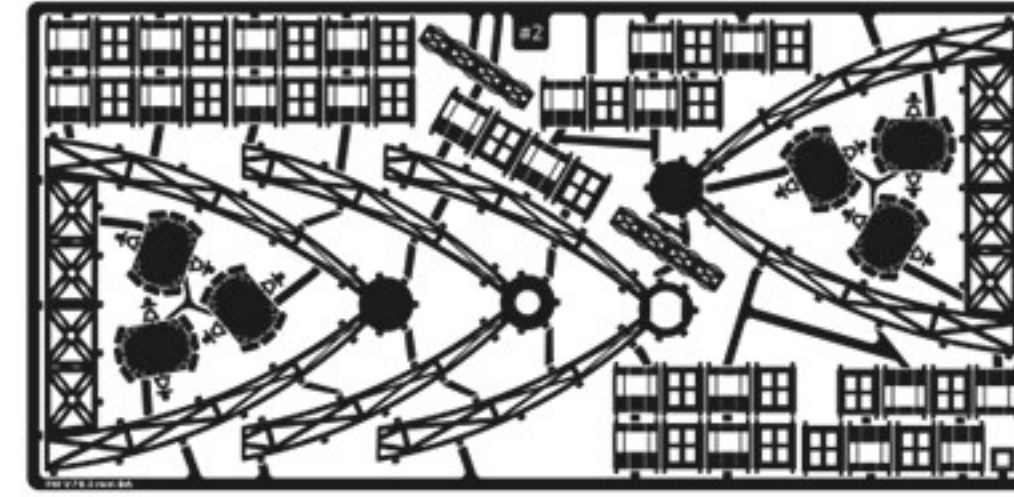

#2

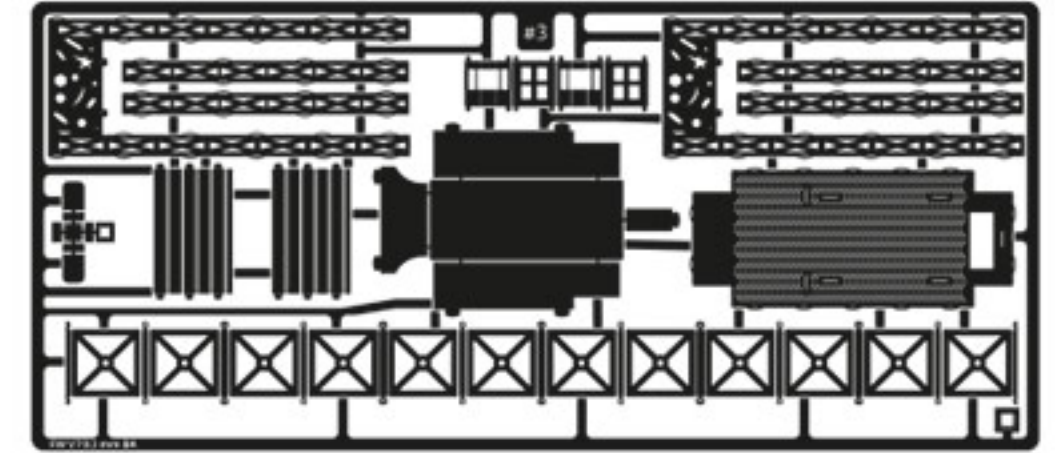

#3

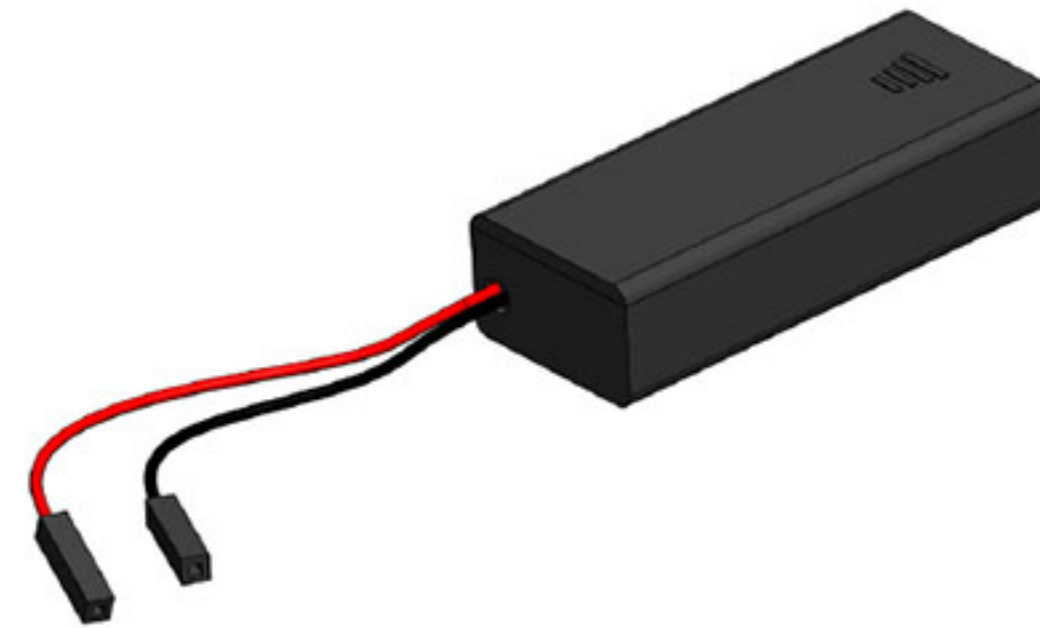

D1



D2

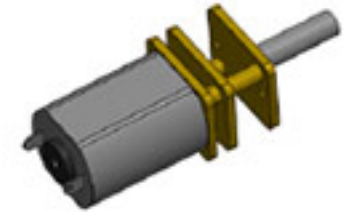

D3

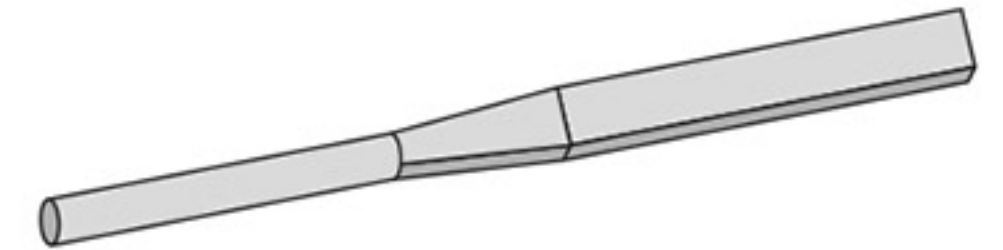
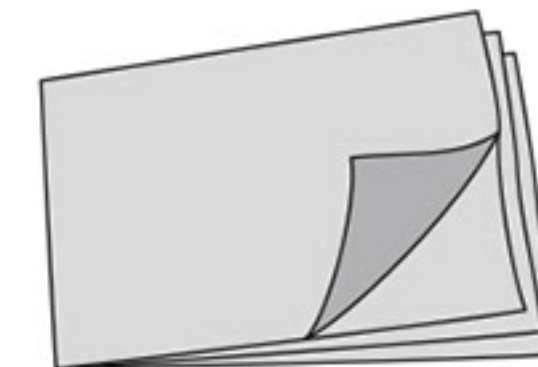
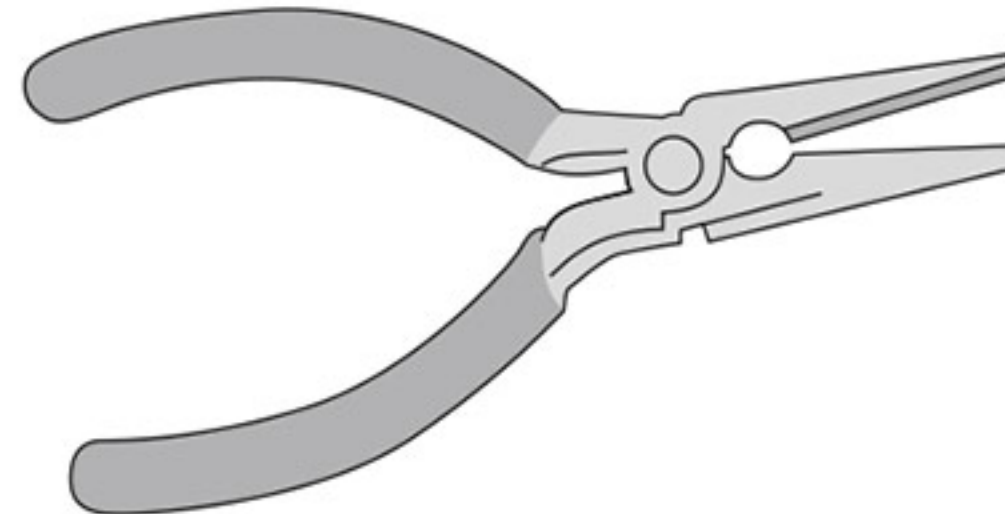



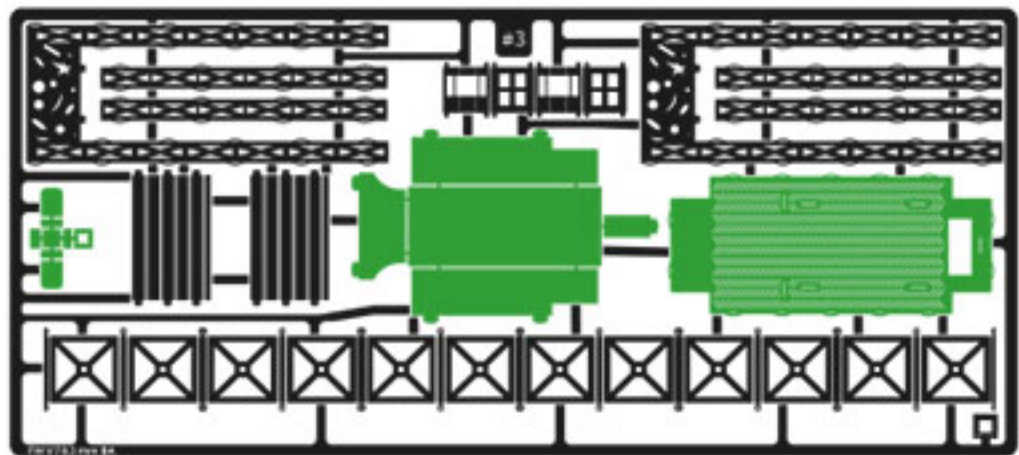

#3

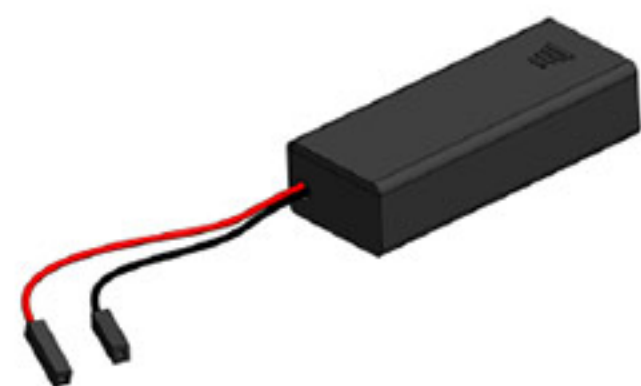
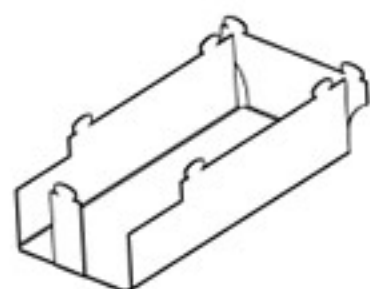
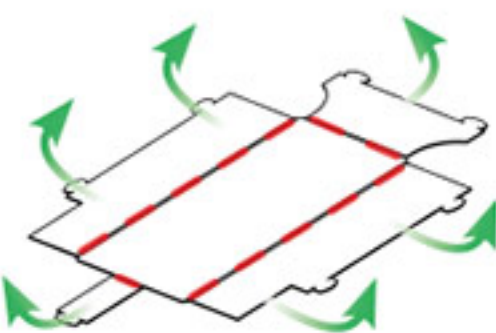
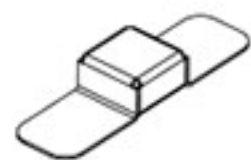
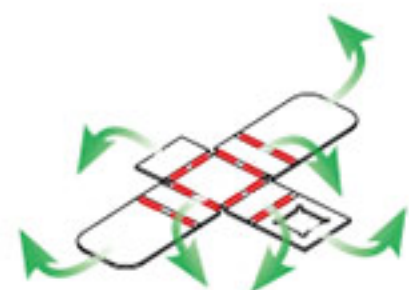

D1



1.1

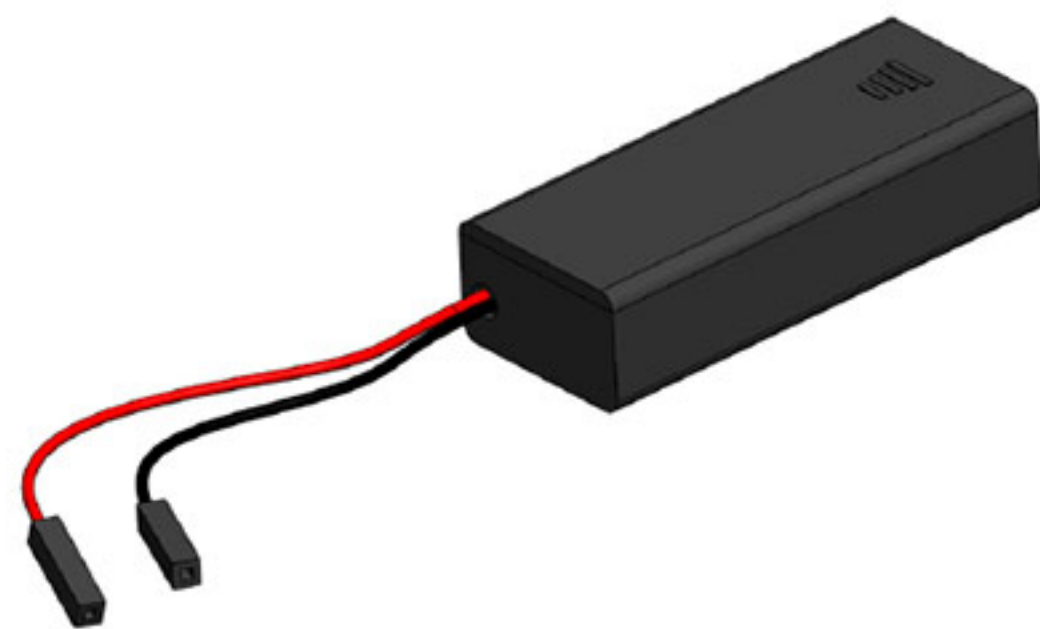
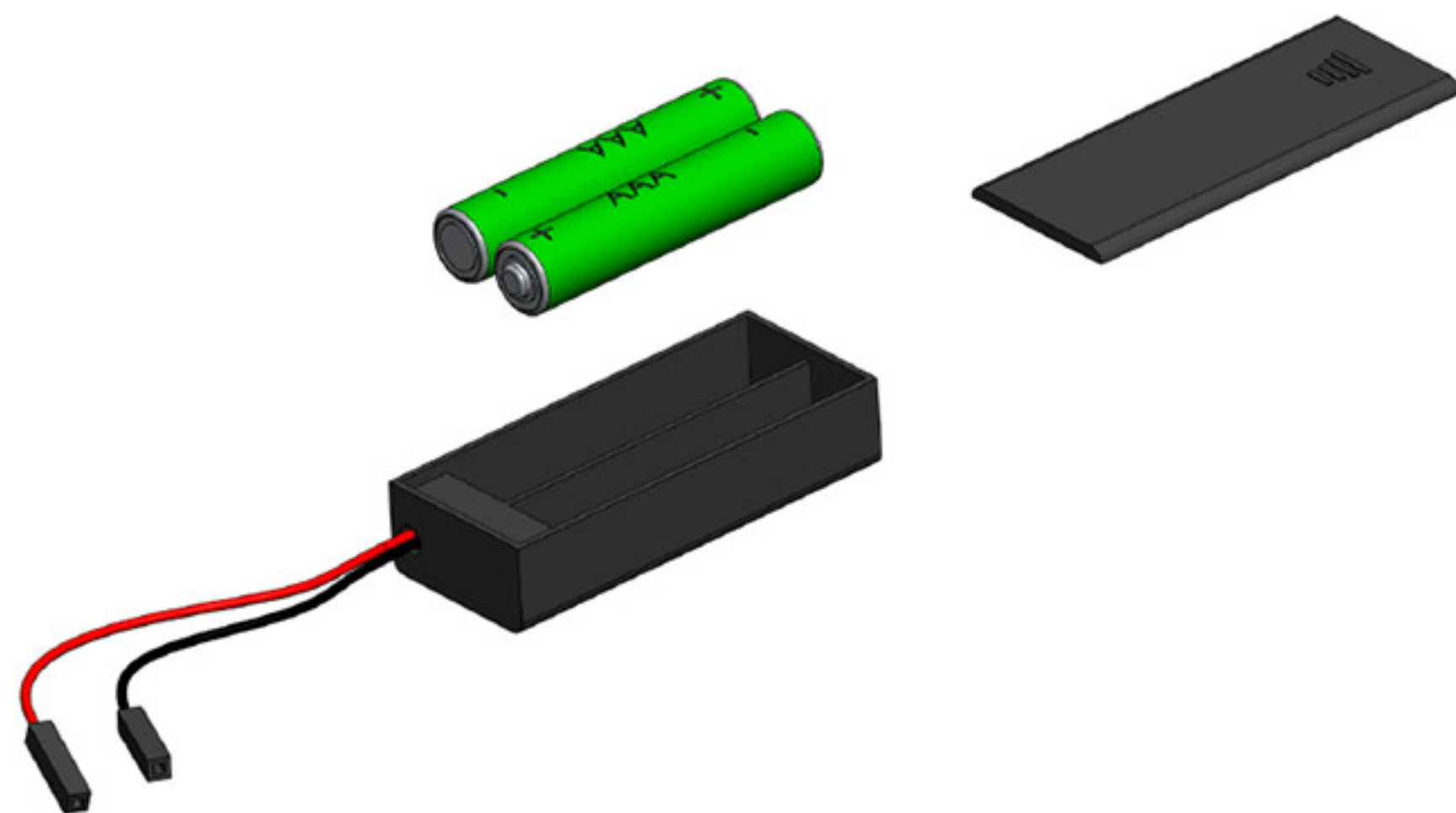

3

1.2

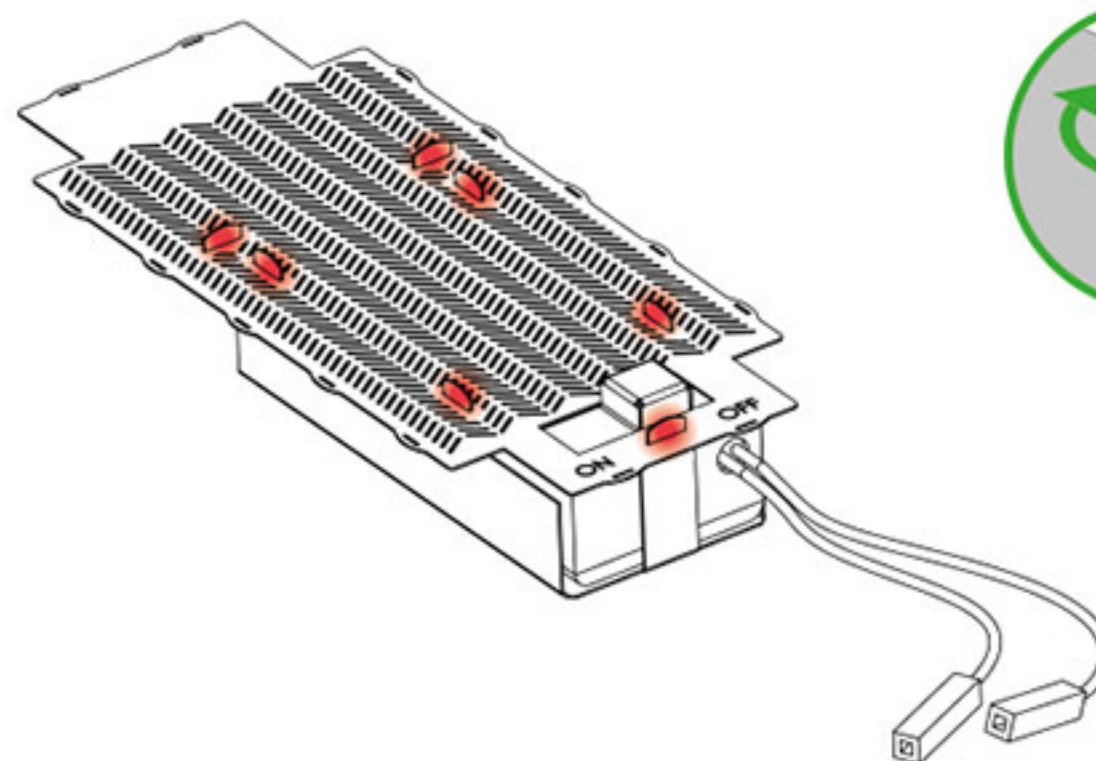
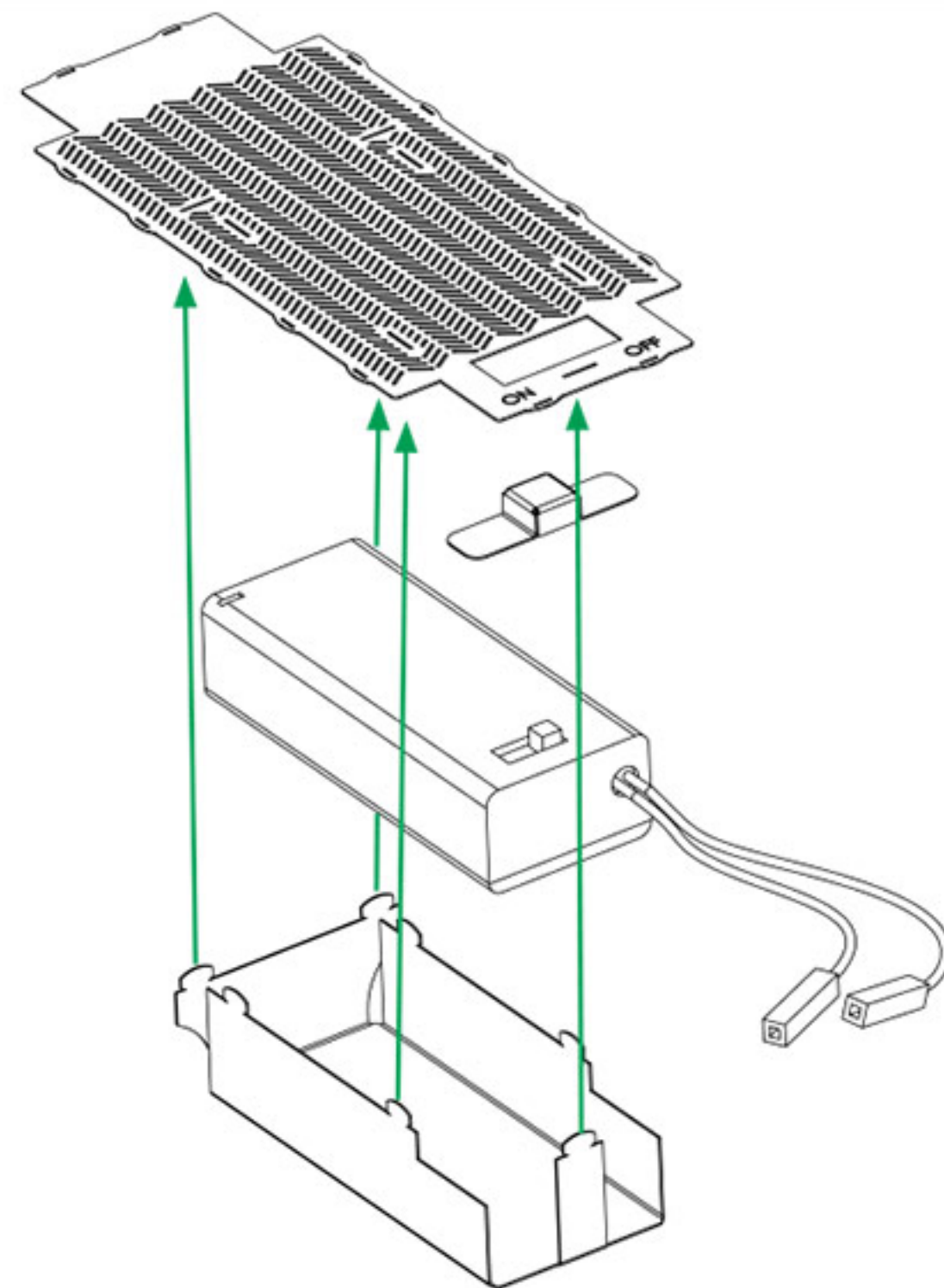

1



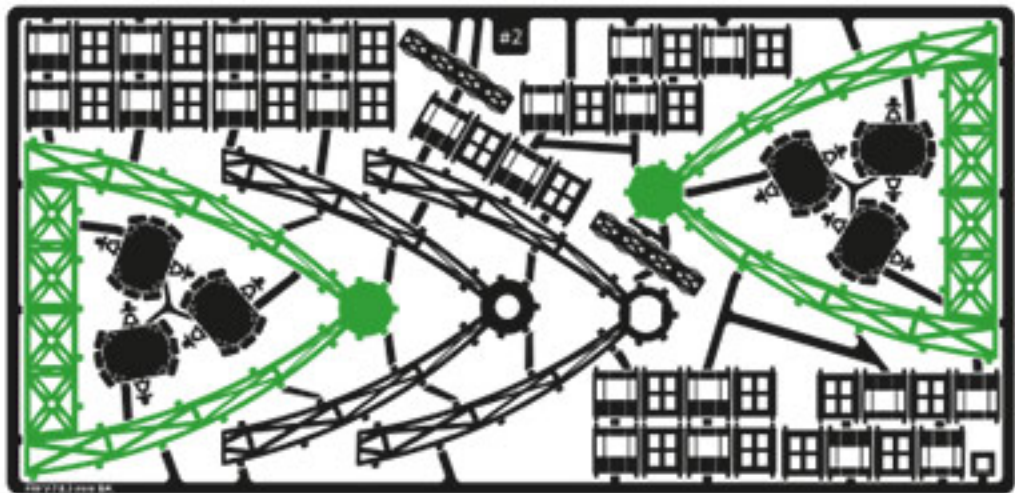

#2

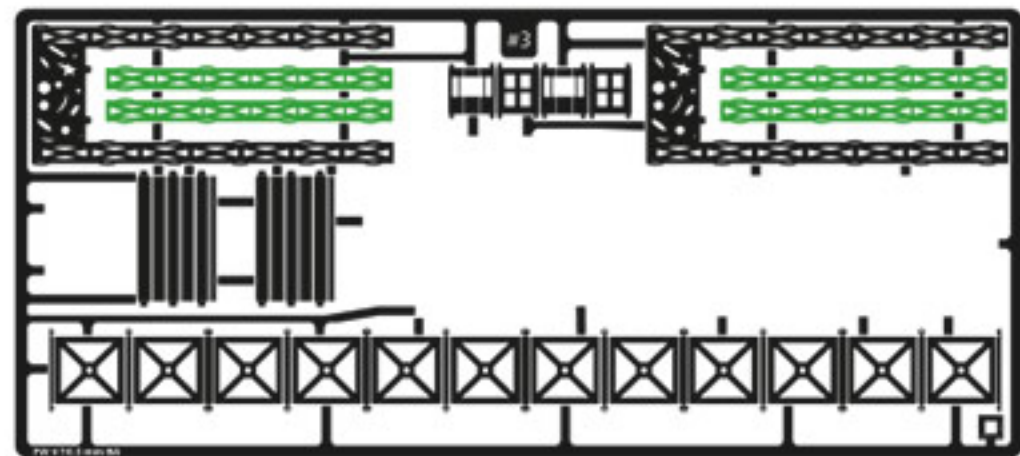

#3

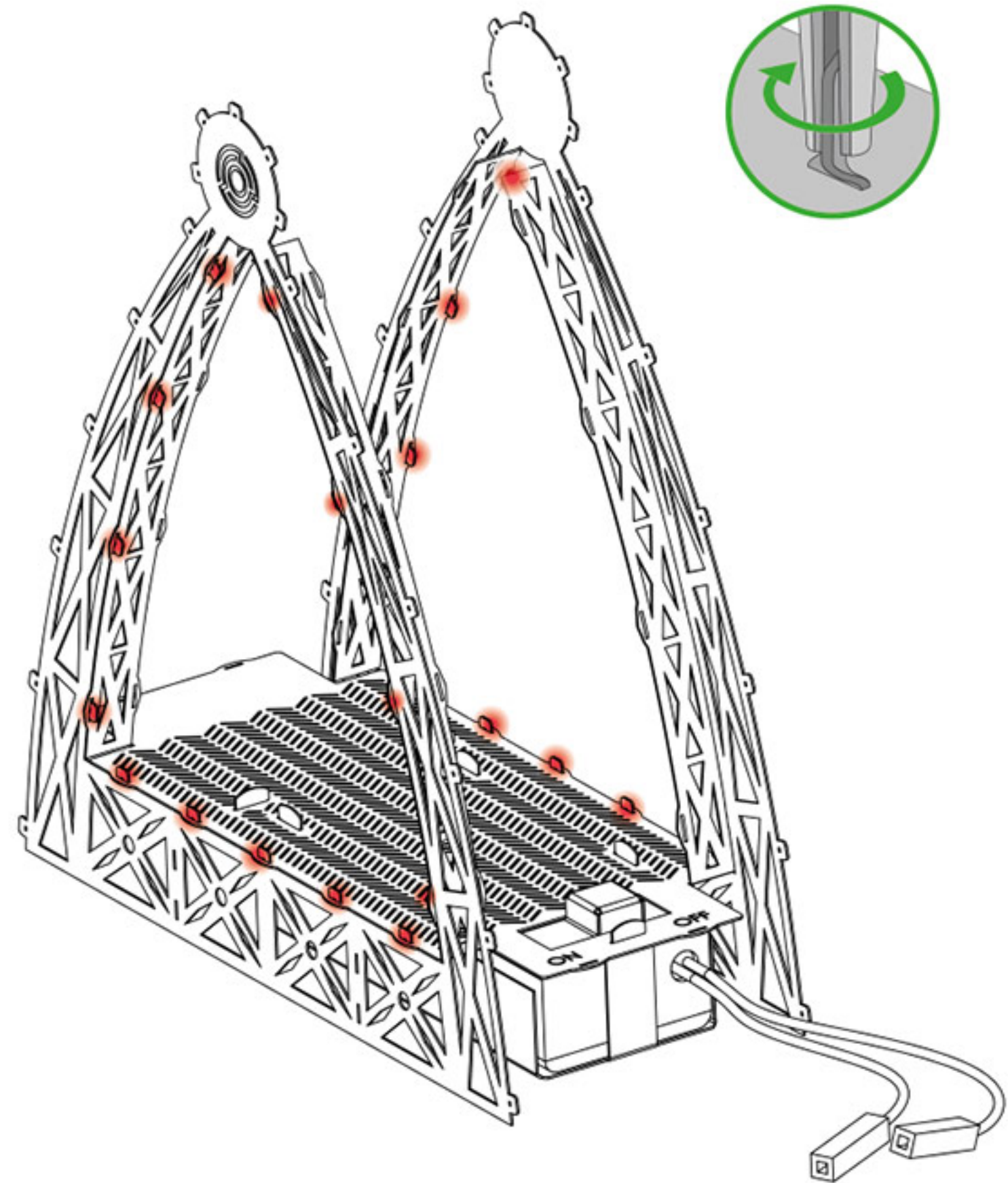
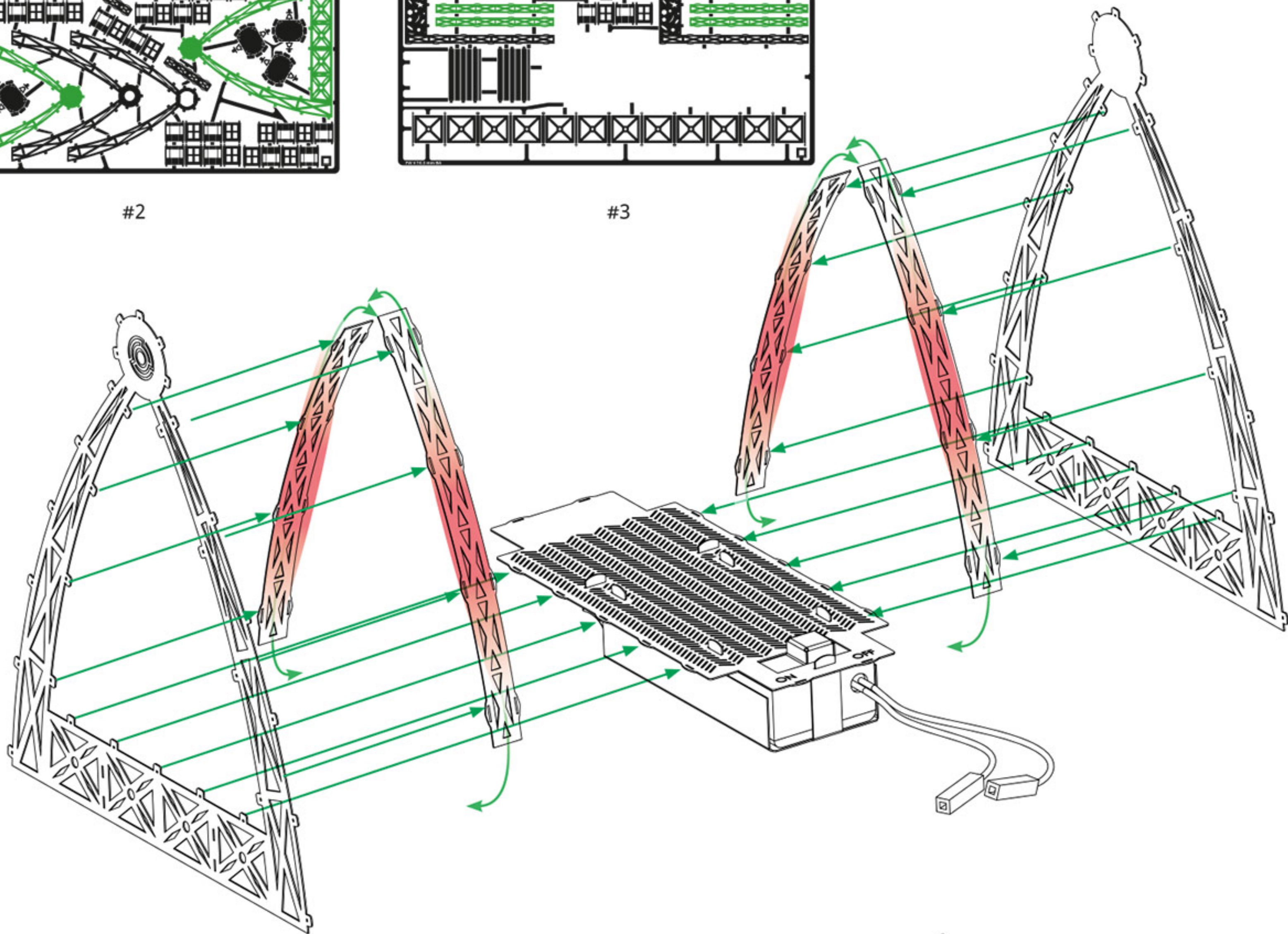



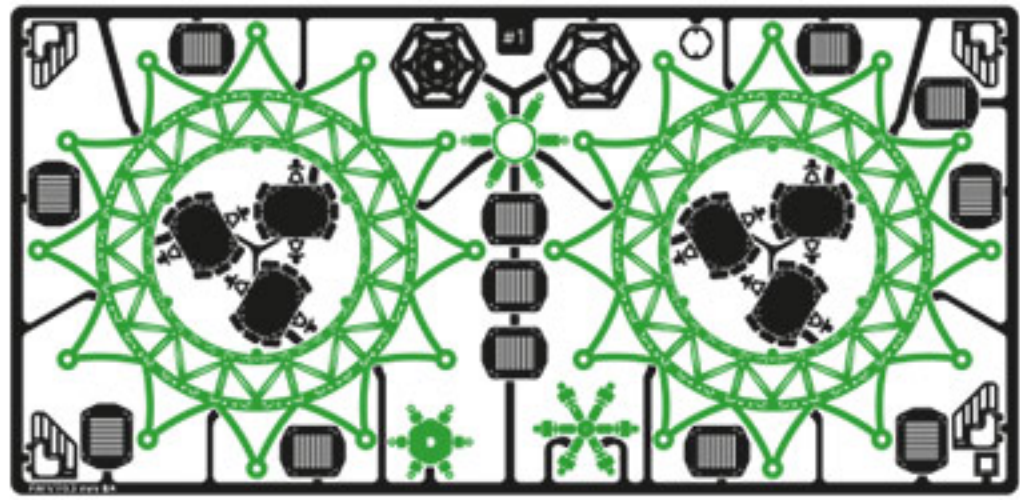

#1

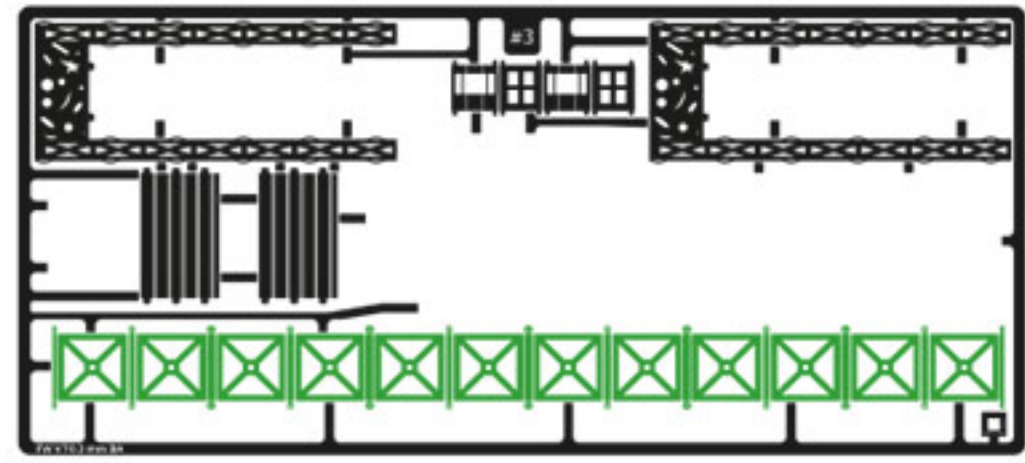

#3

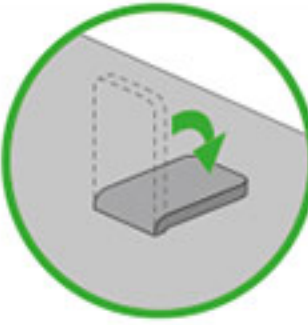
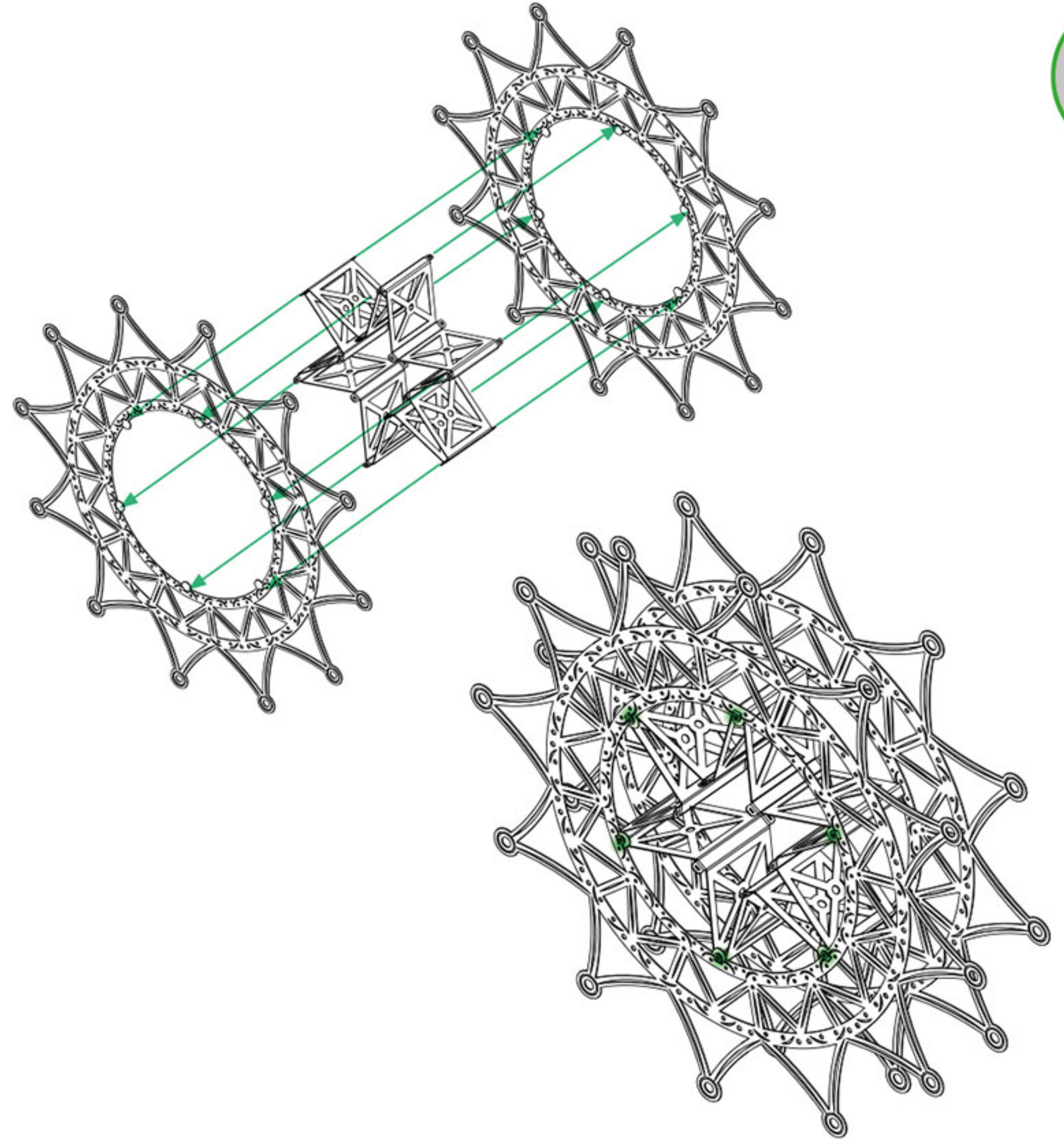
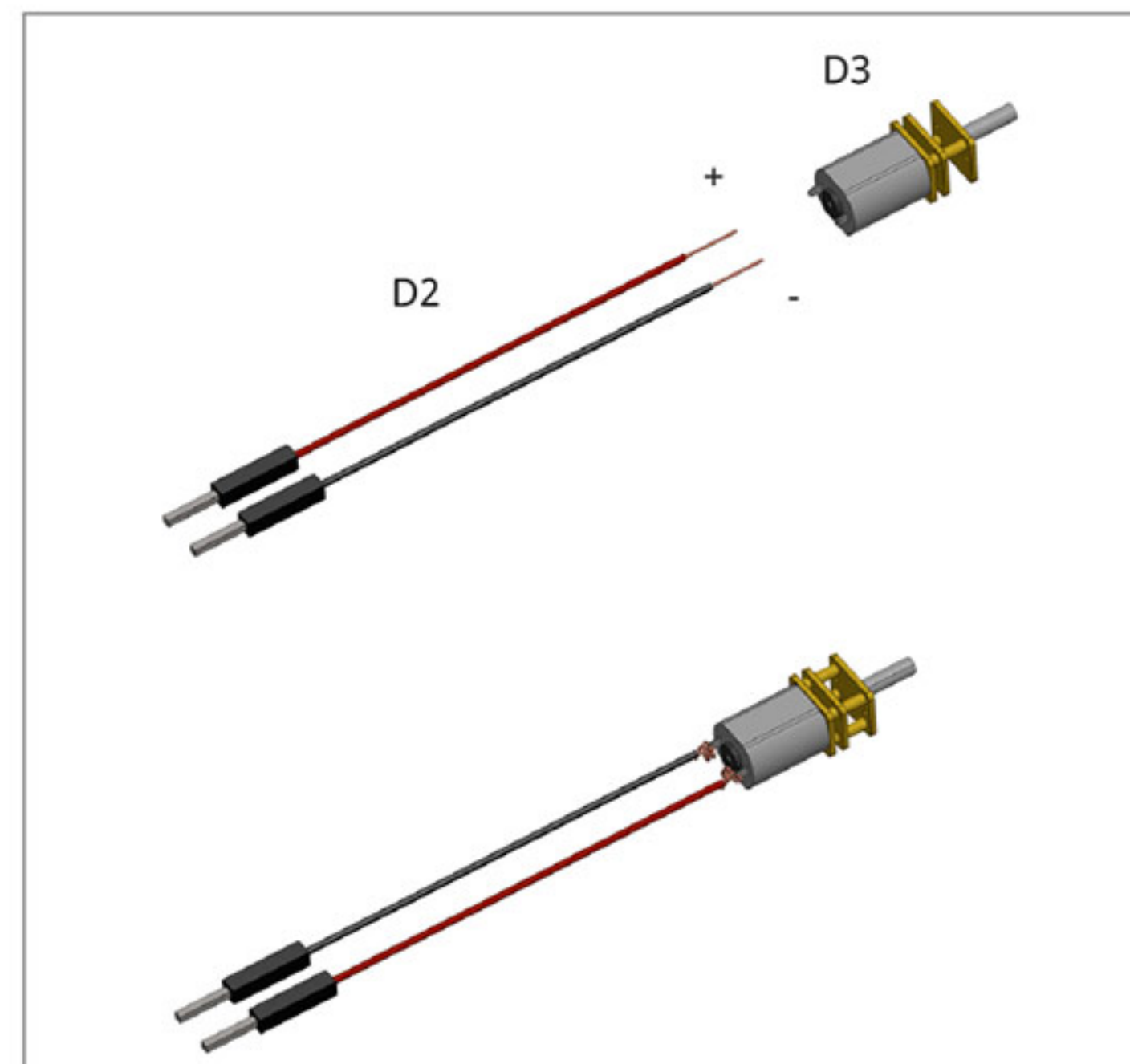
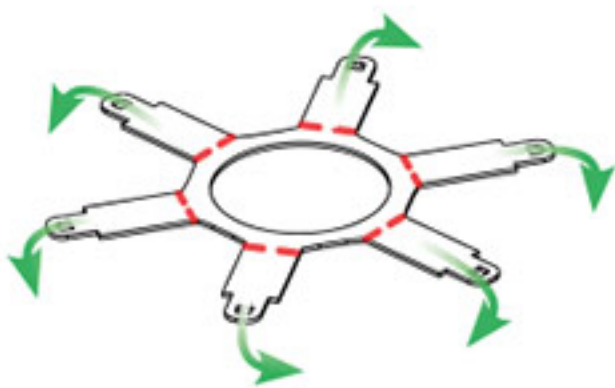
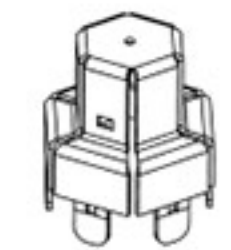
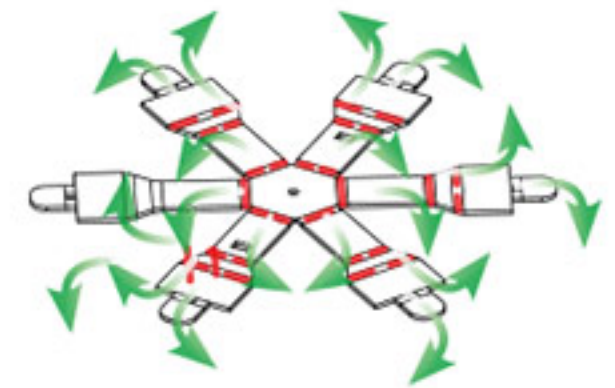
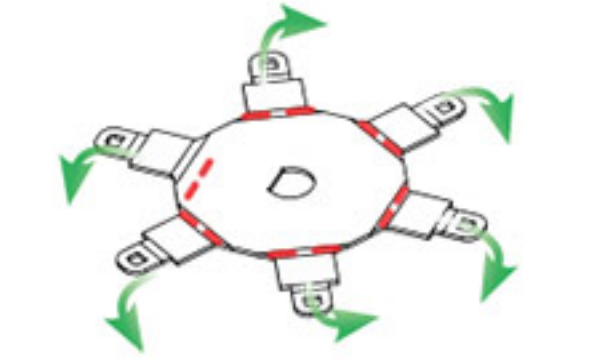
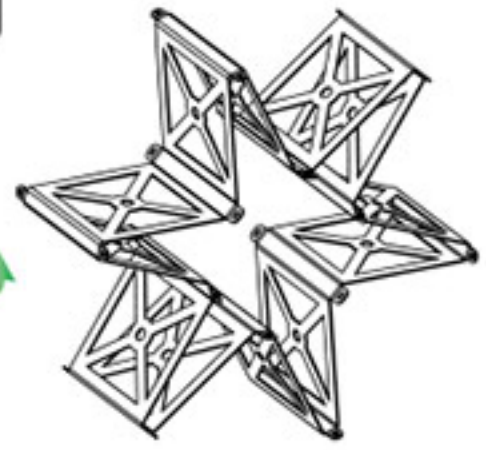
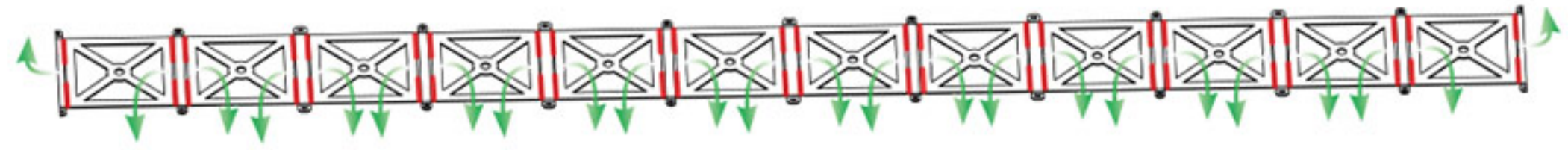



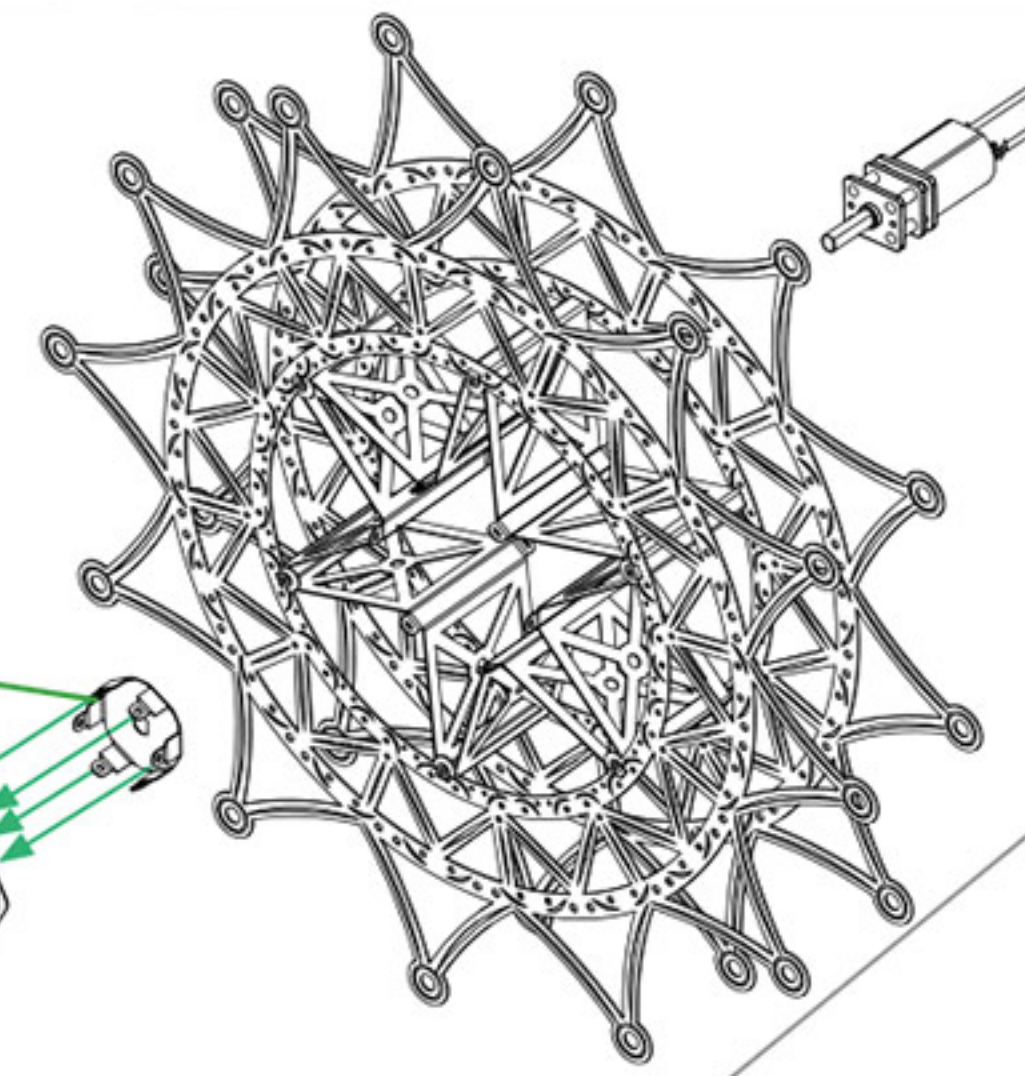
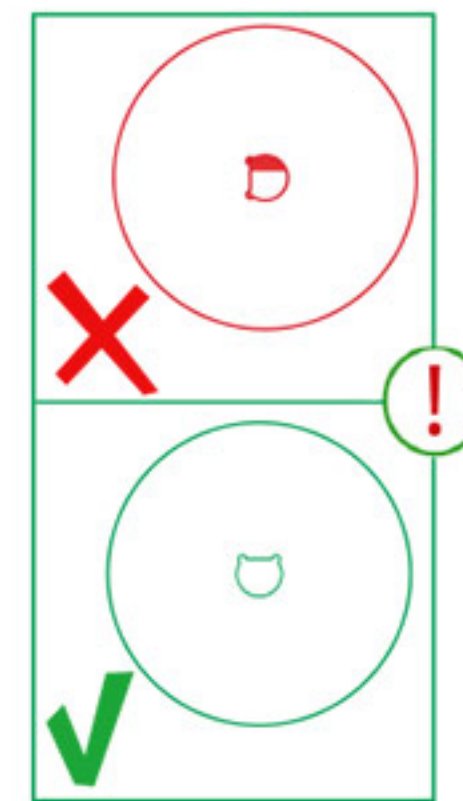
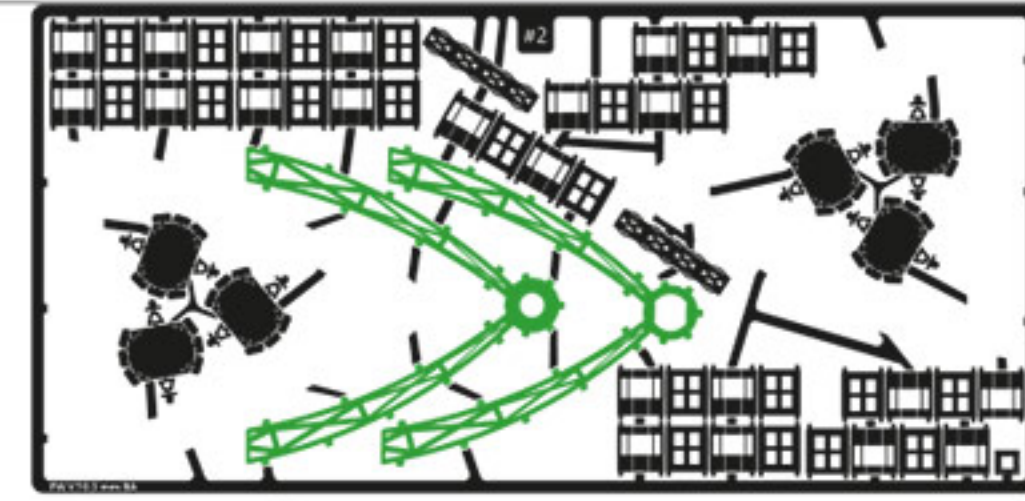
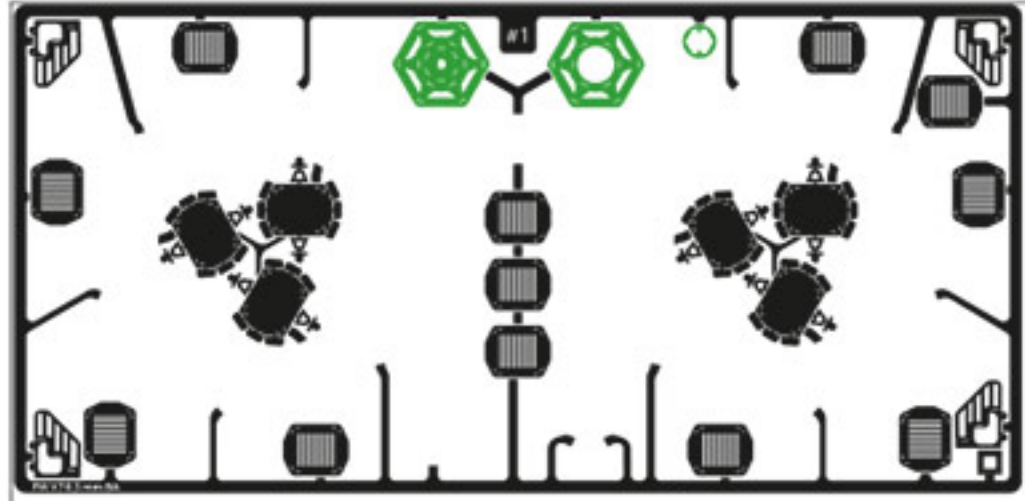

4.1

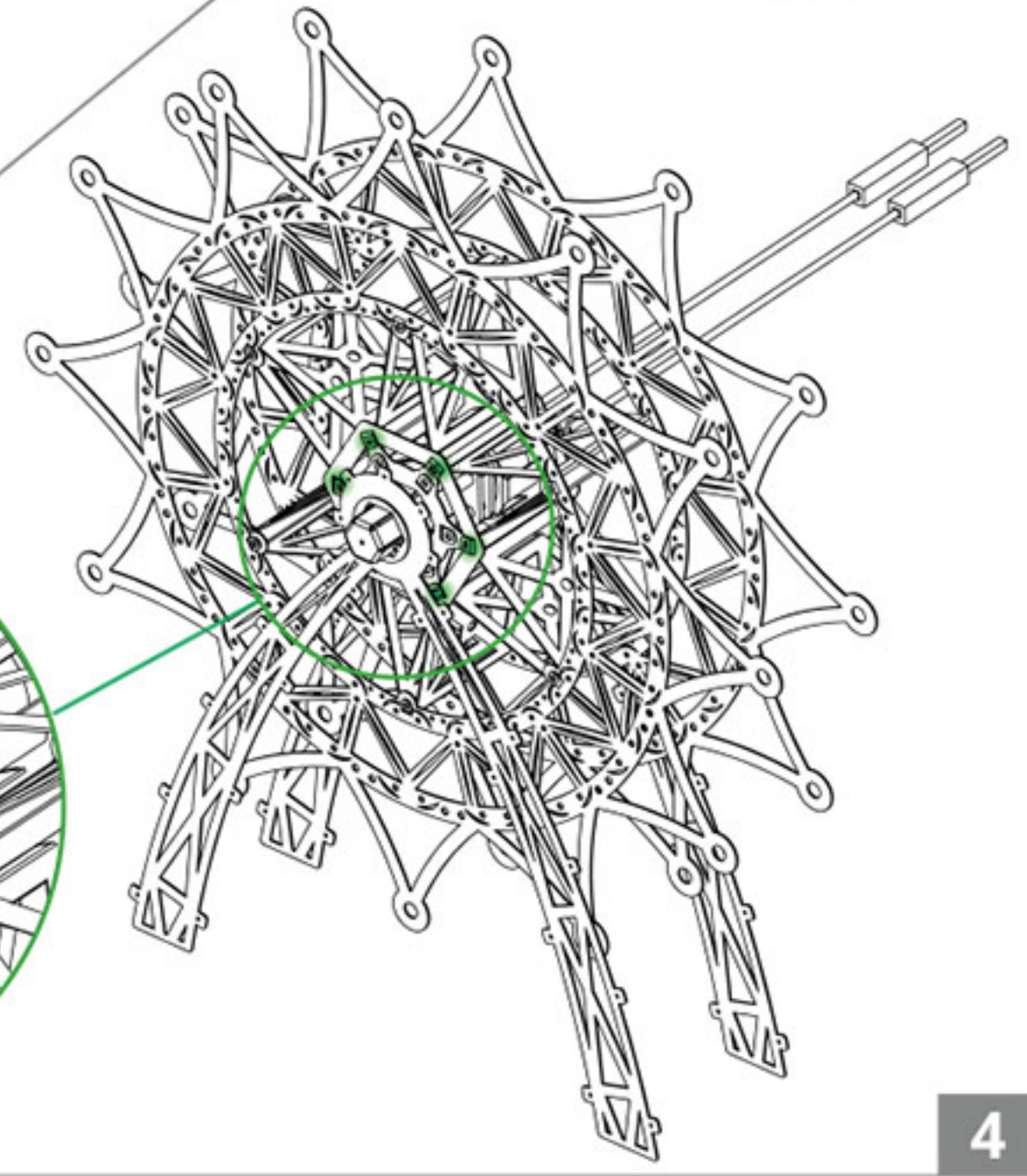
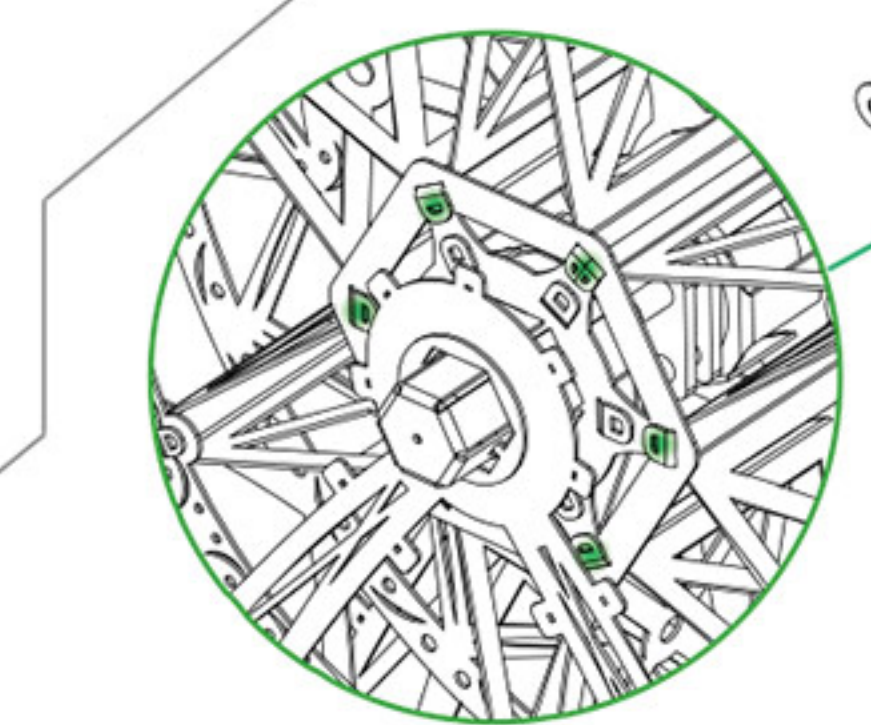
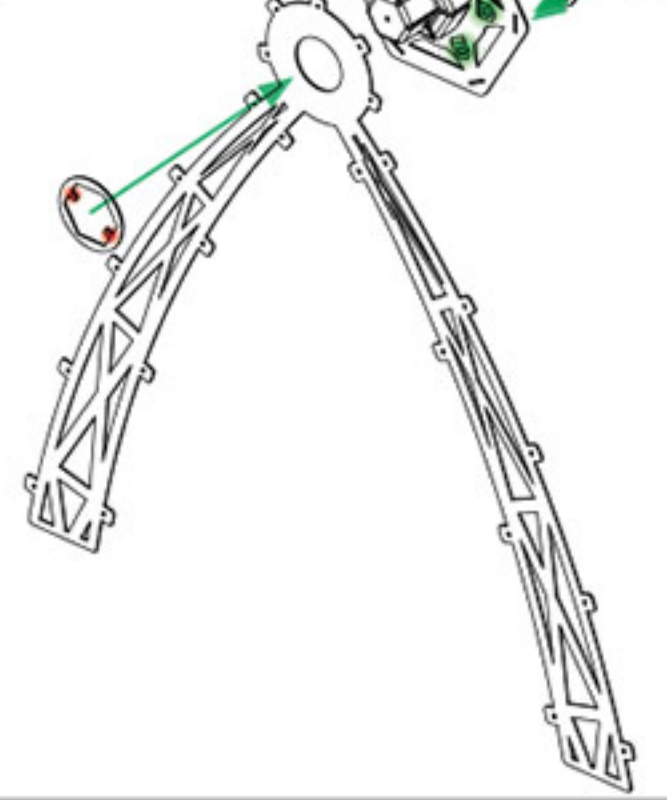
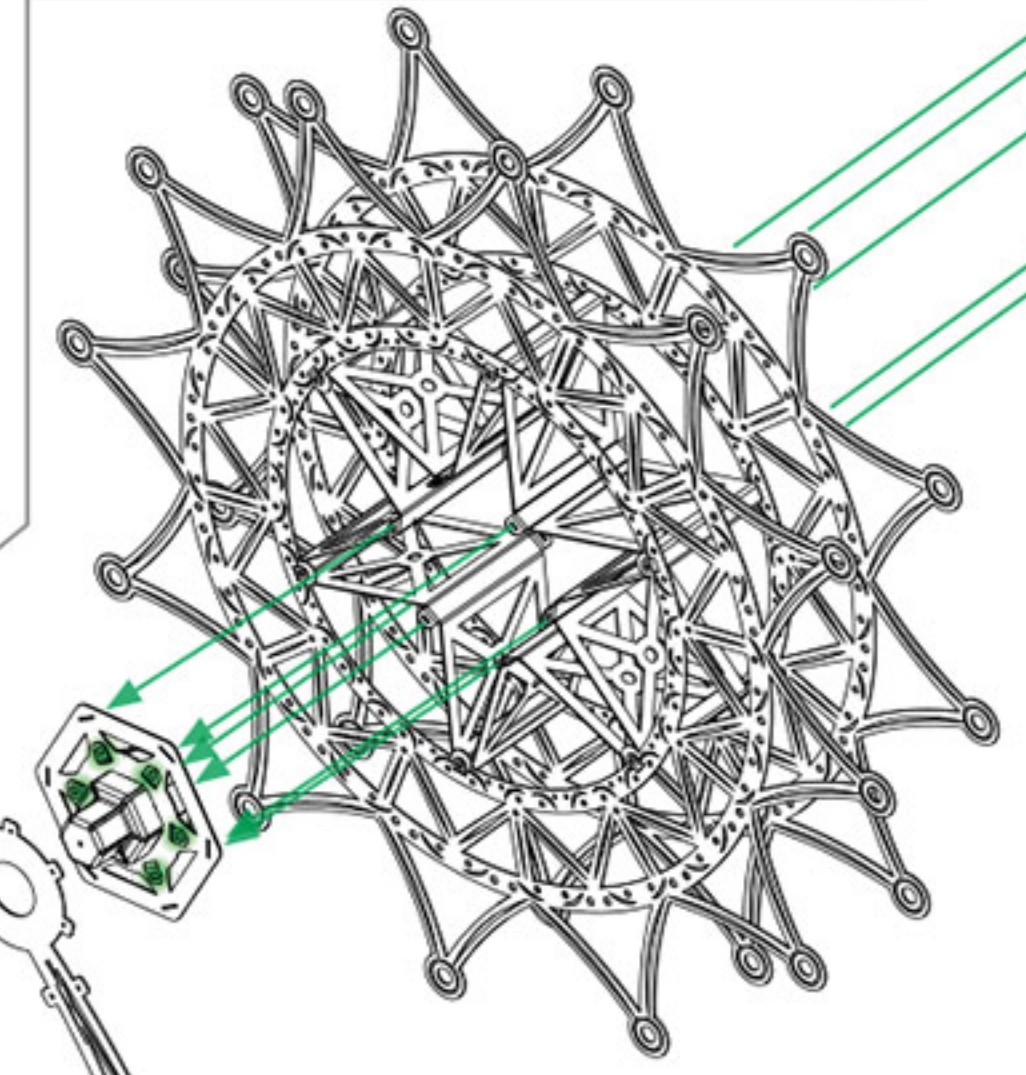



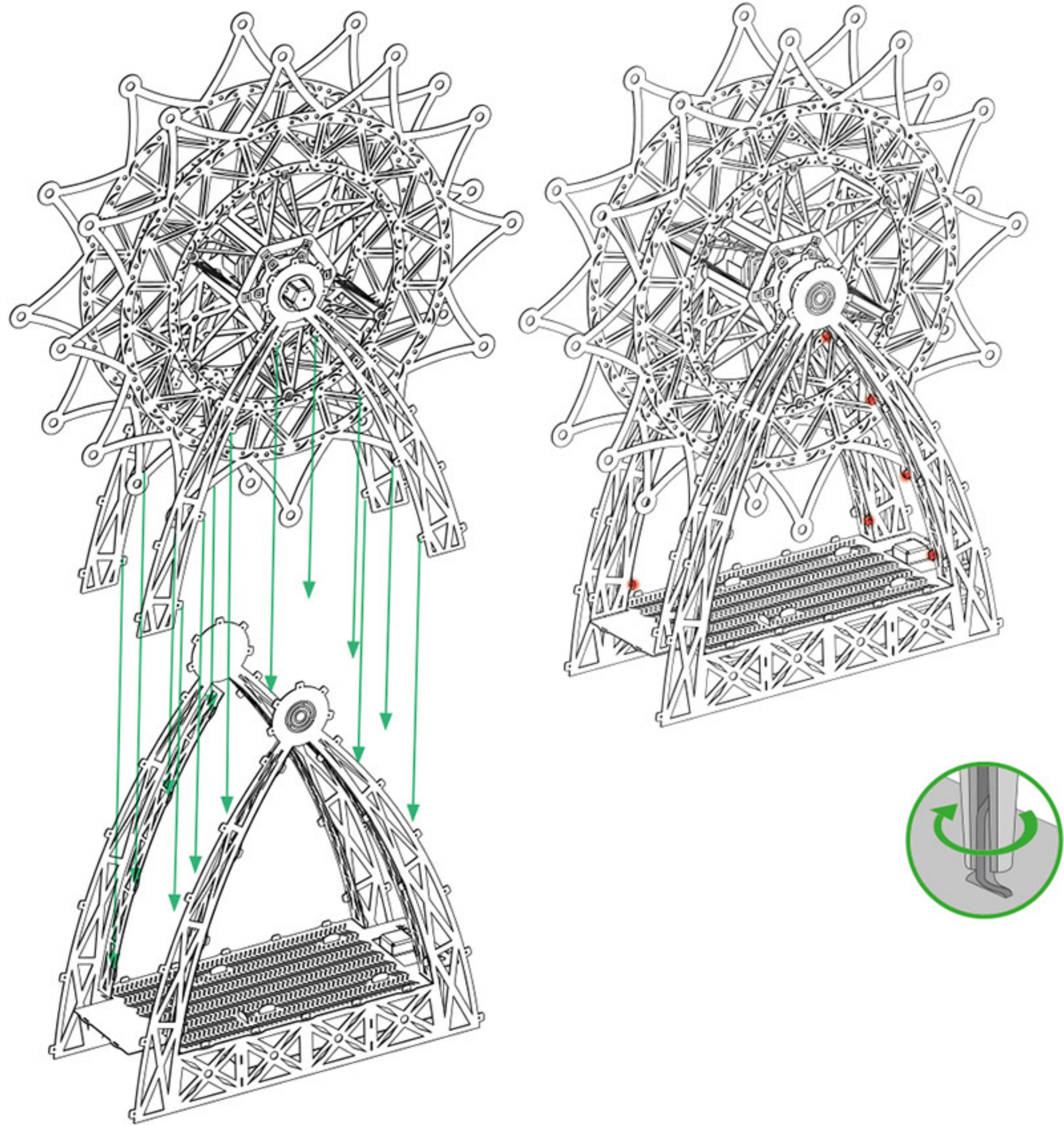

5.1

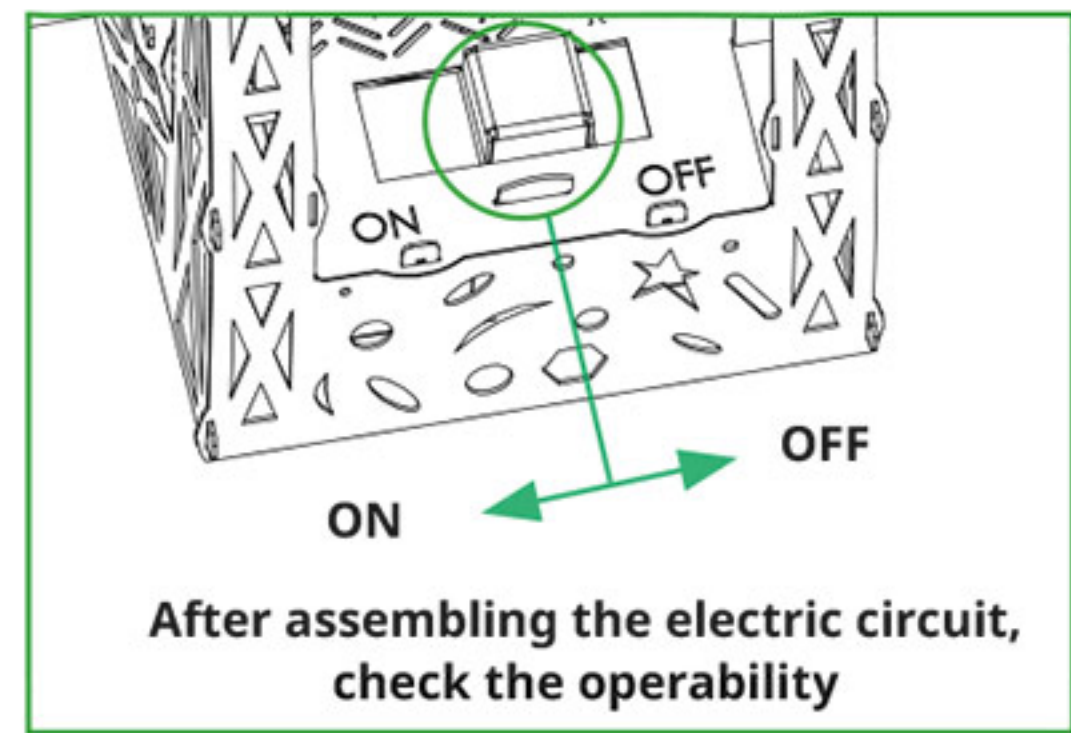
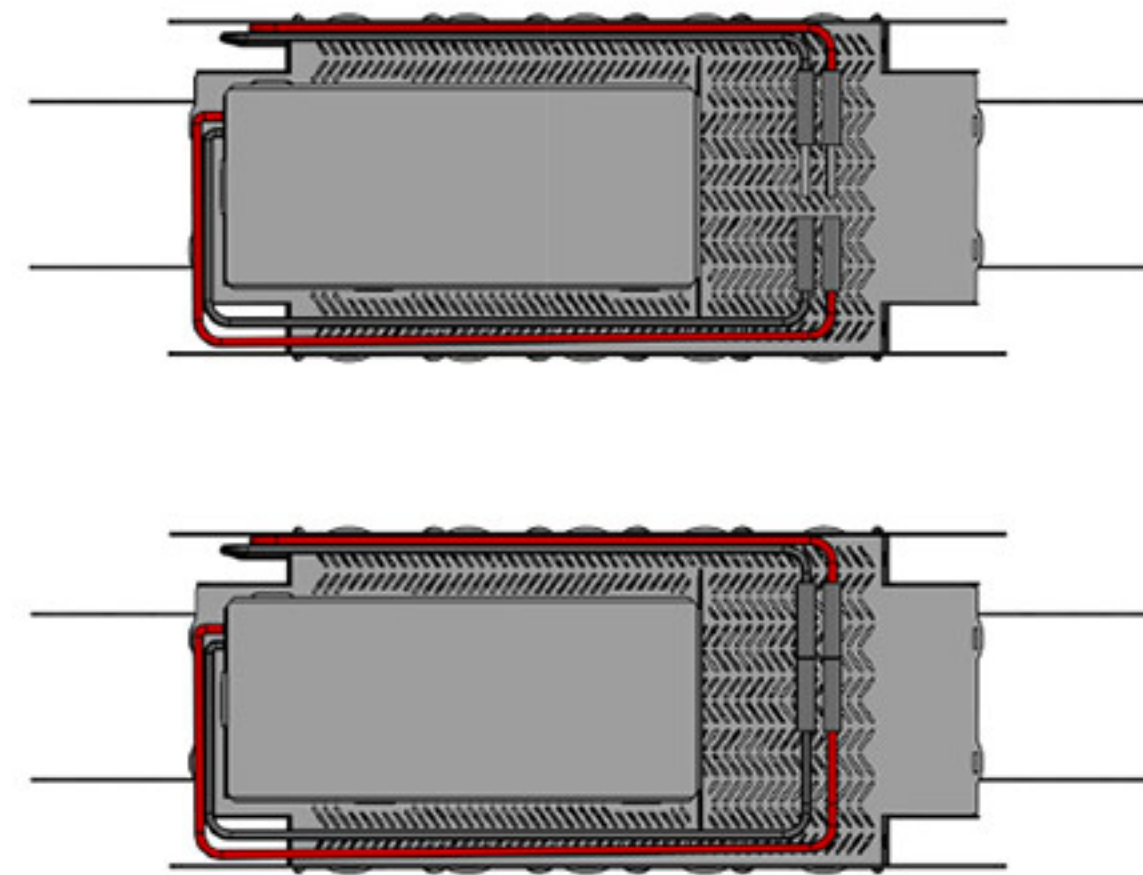
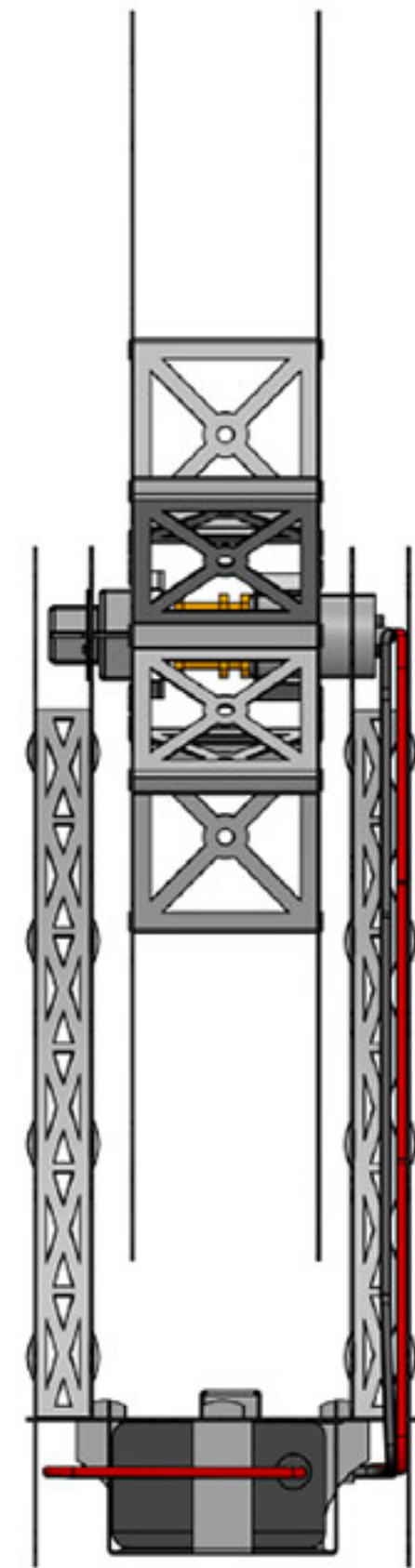

5.2

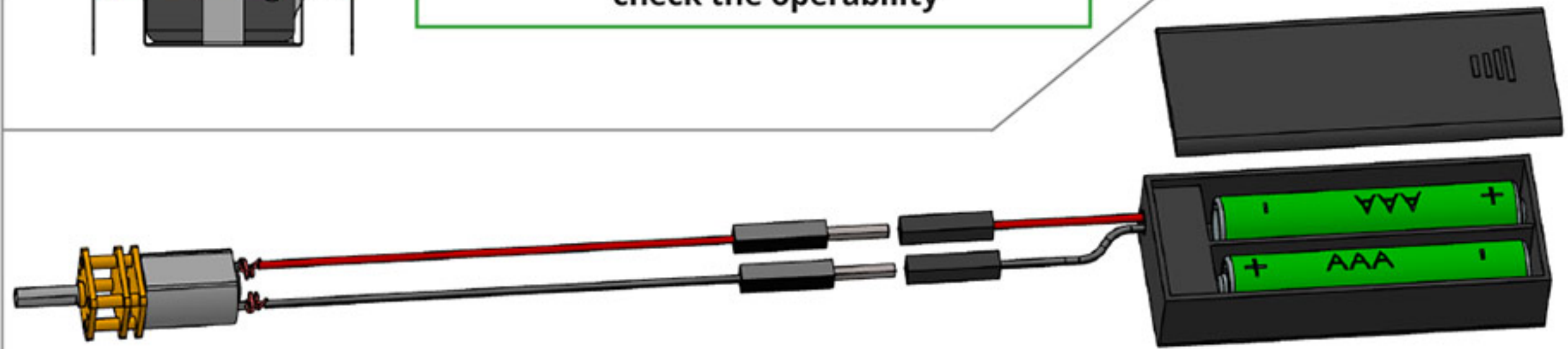

5



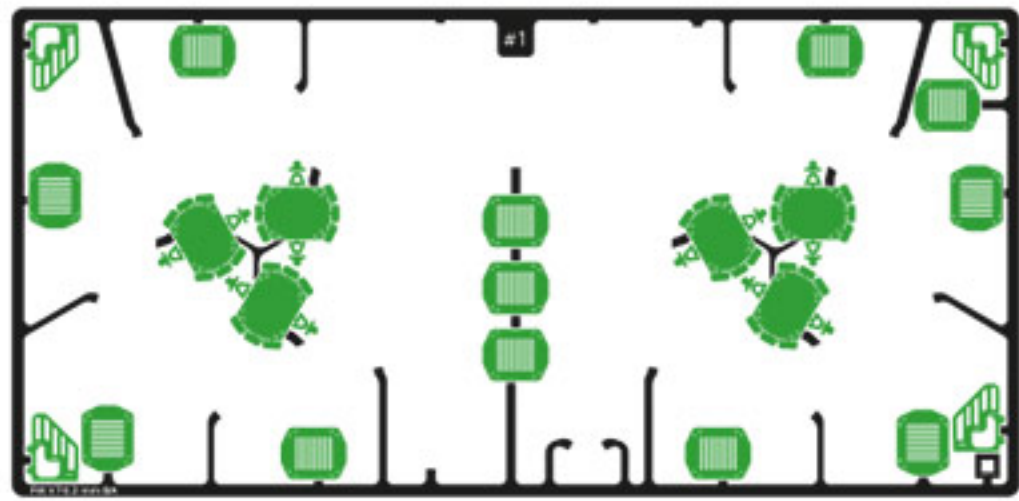

#1



#2

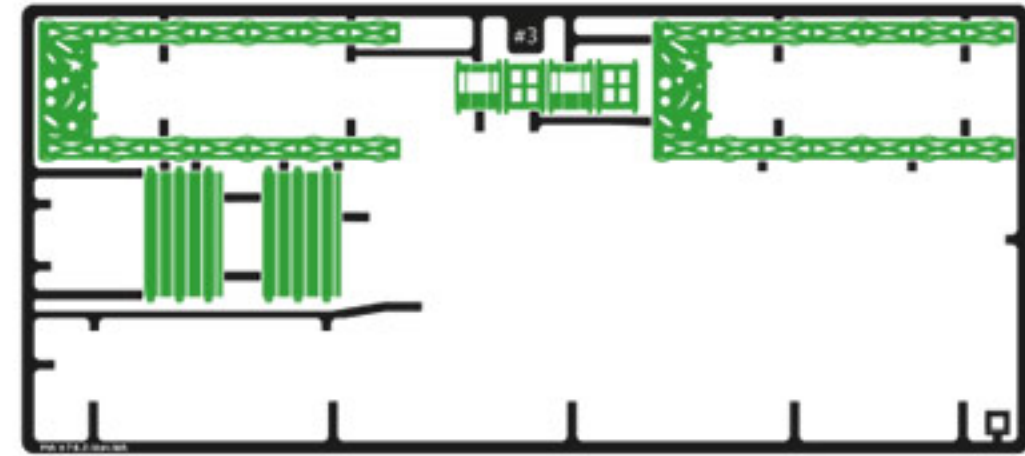

#3

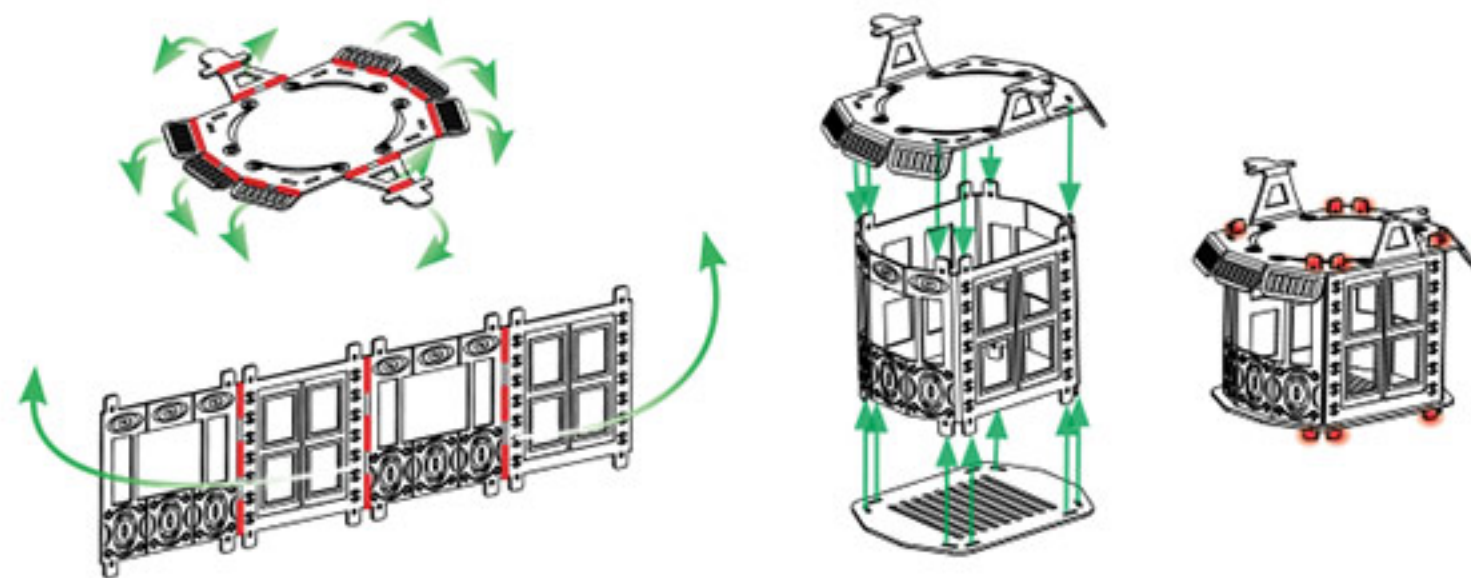

X12

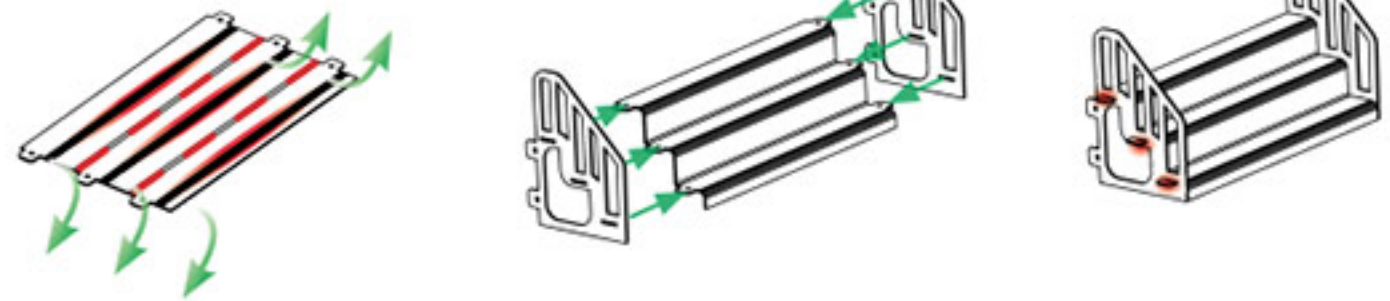

X2

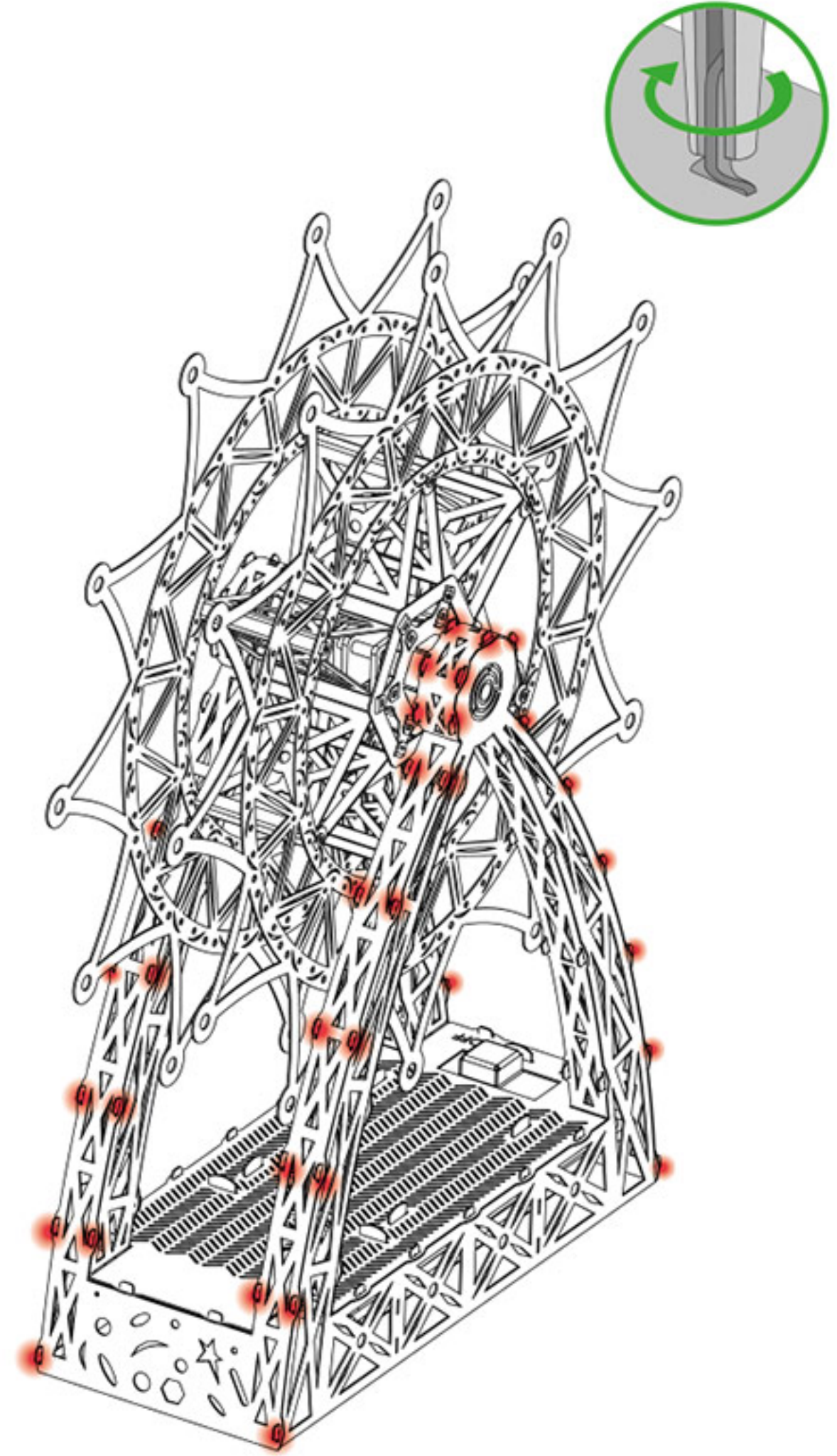
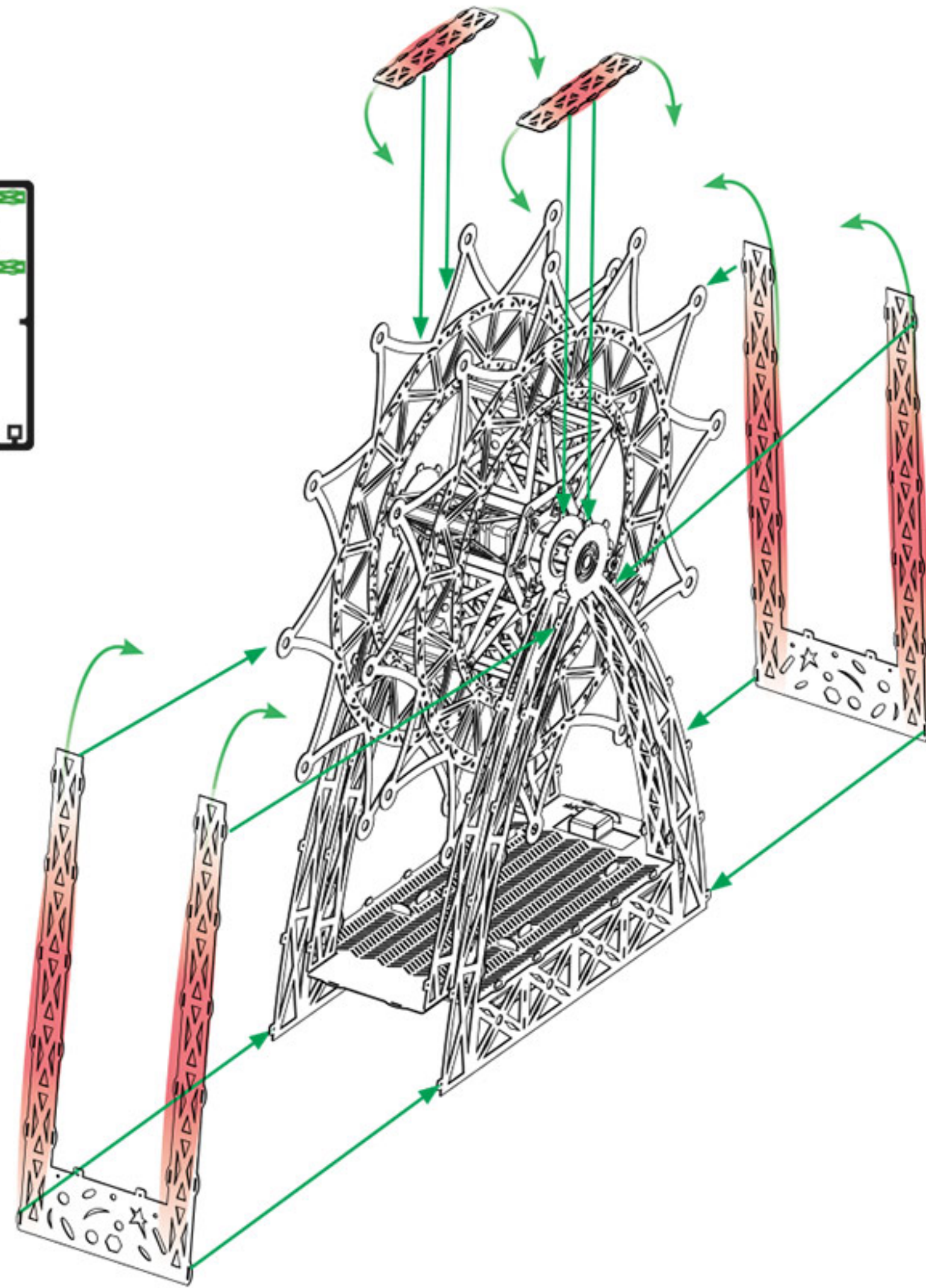



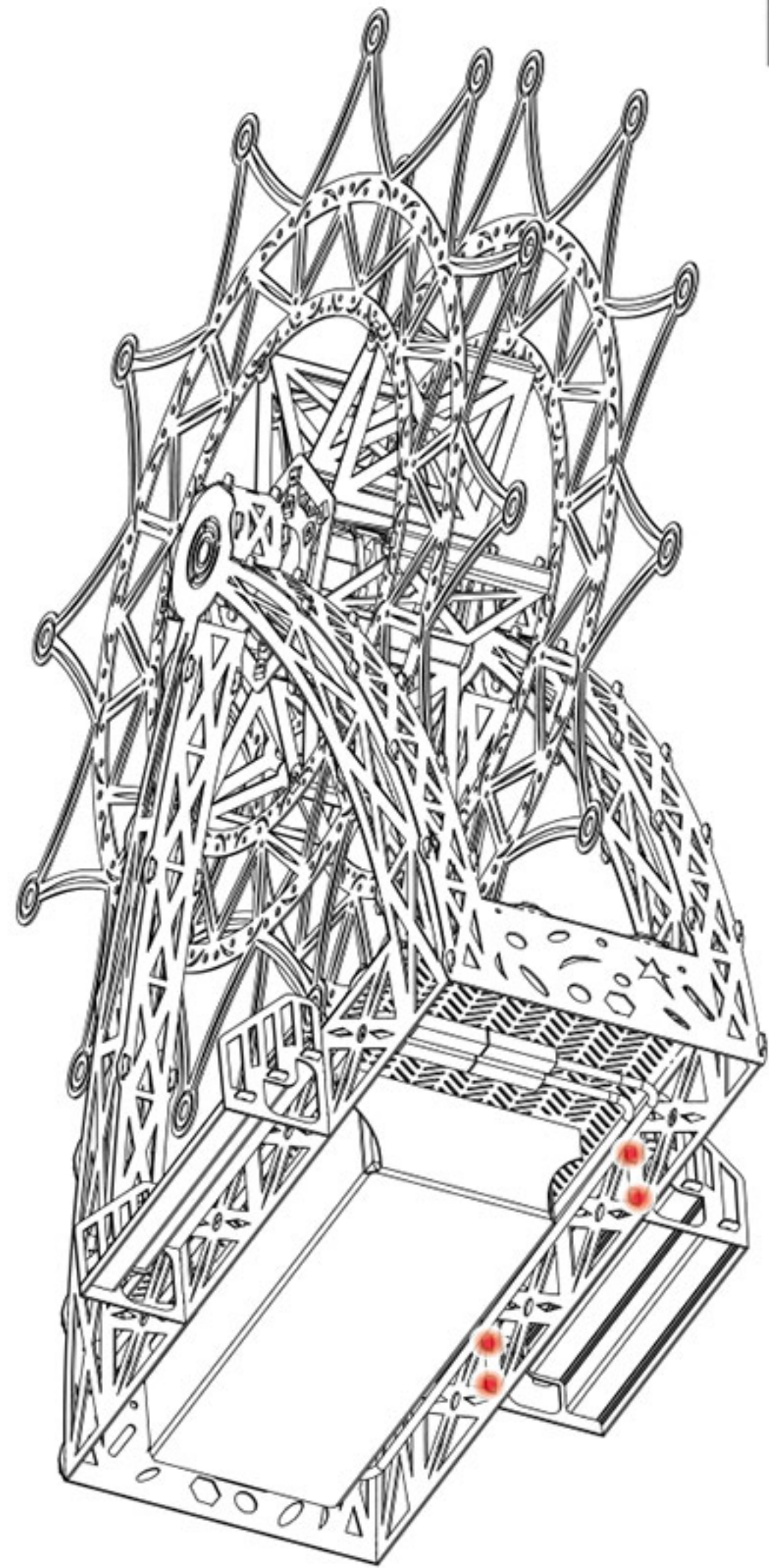
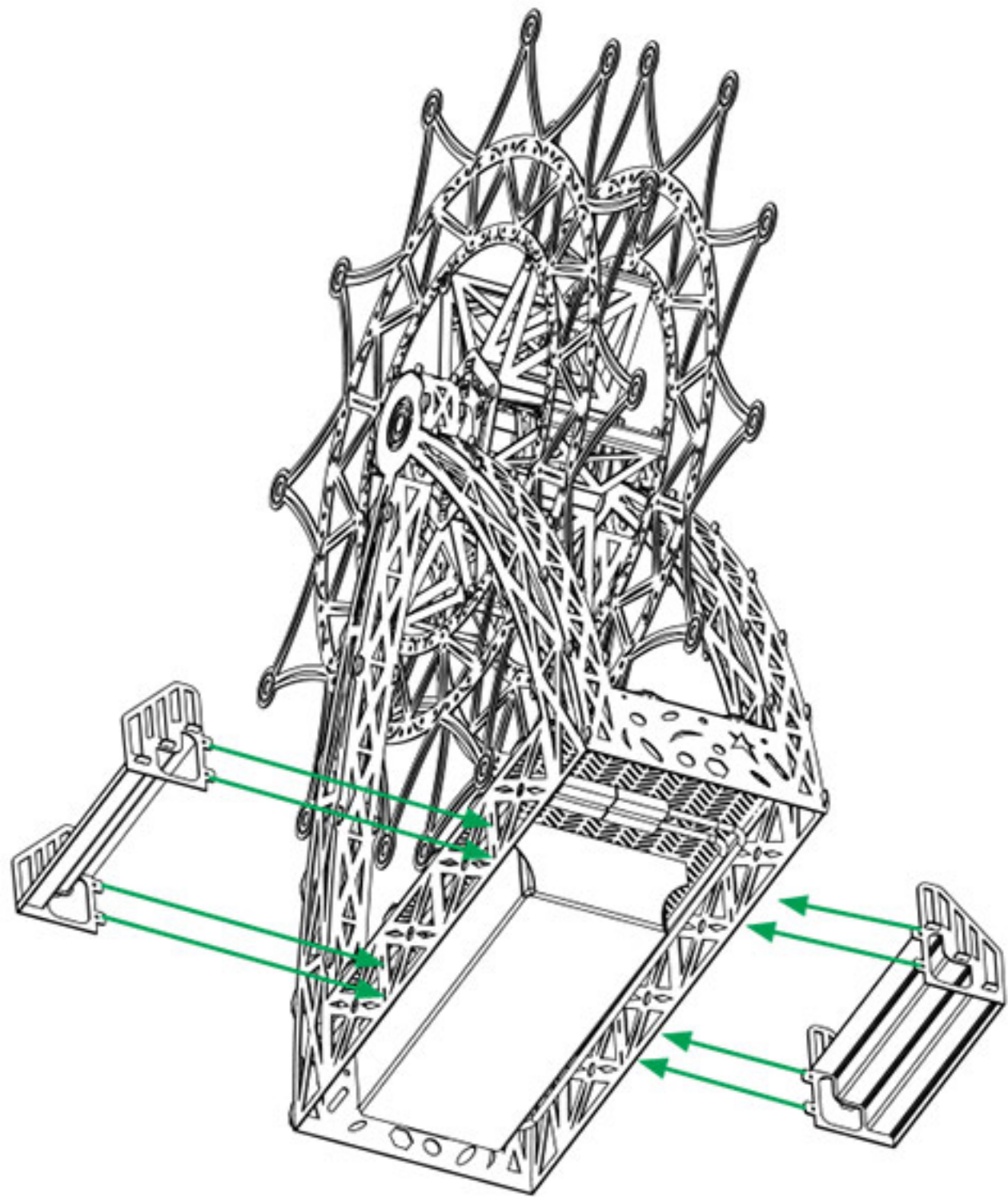

7.1

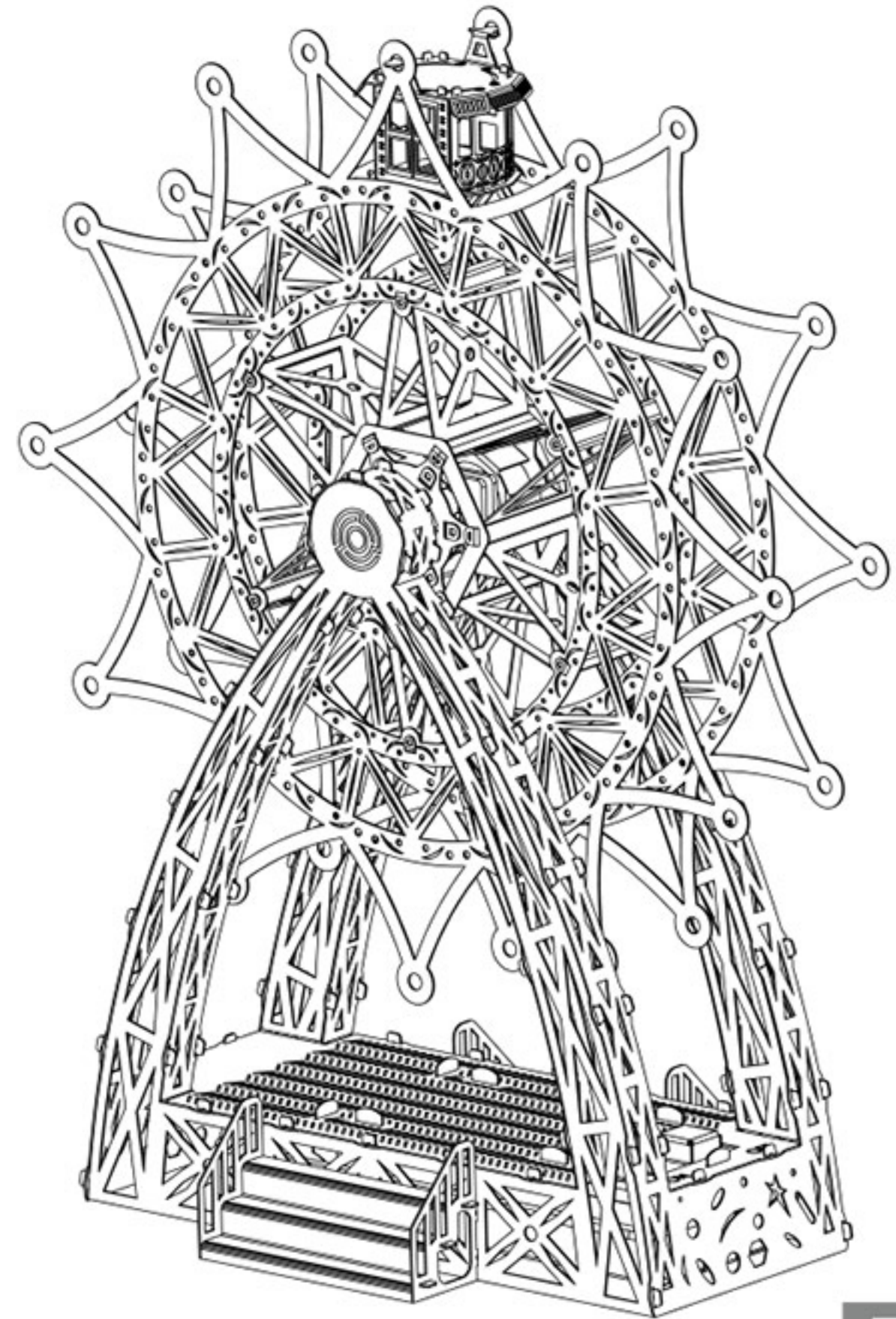
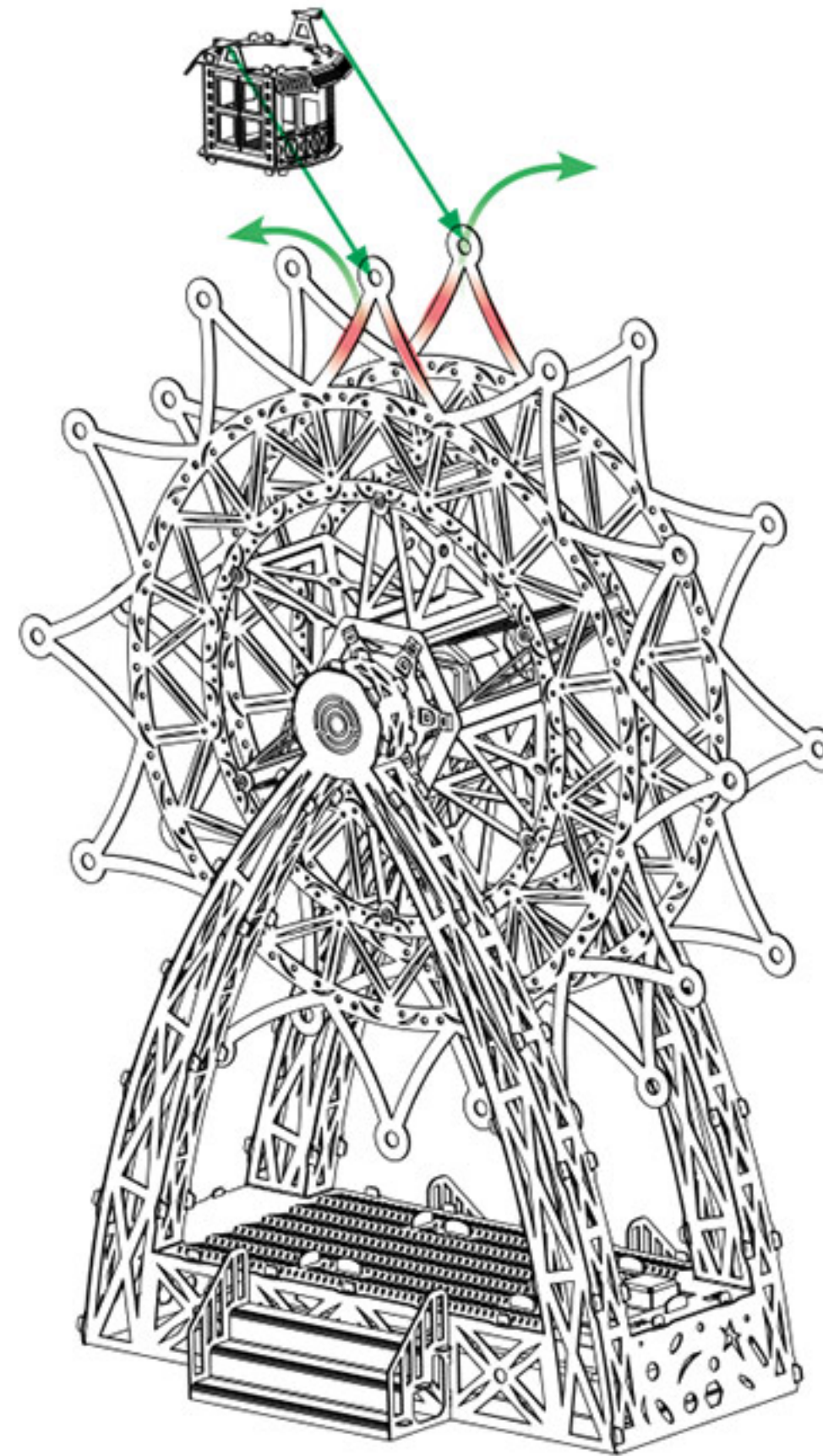

X12

7.2



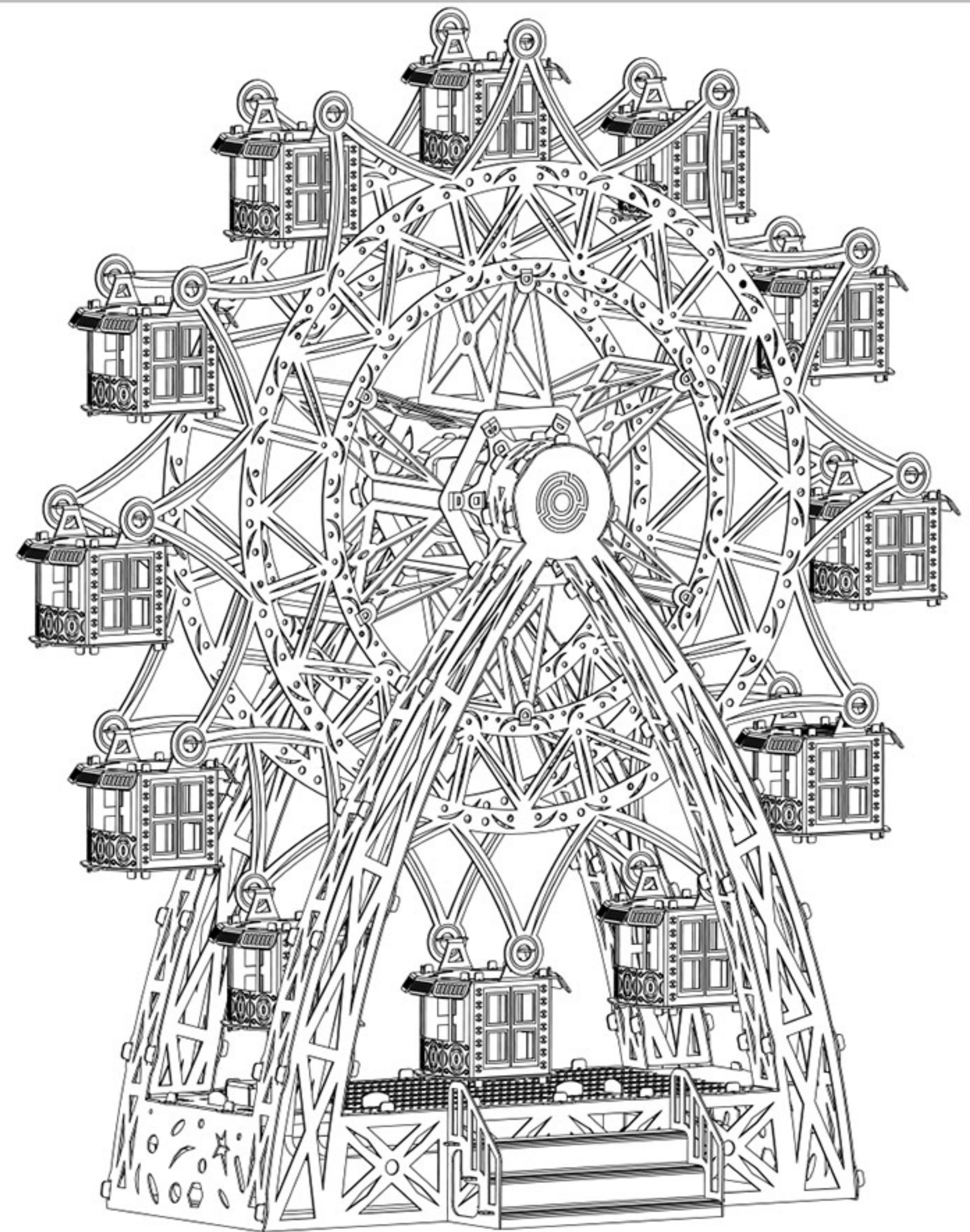
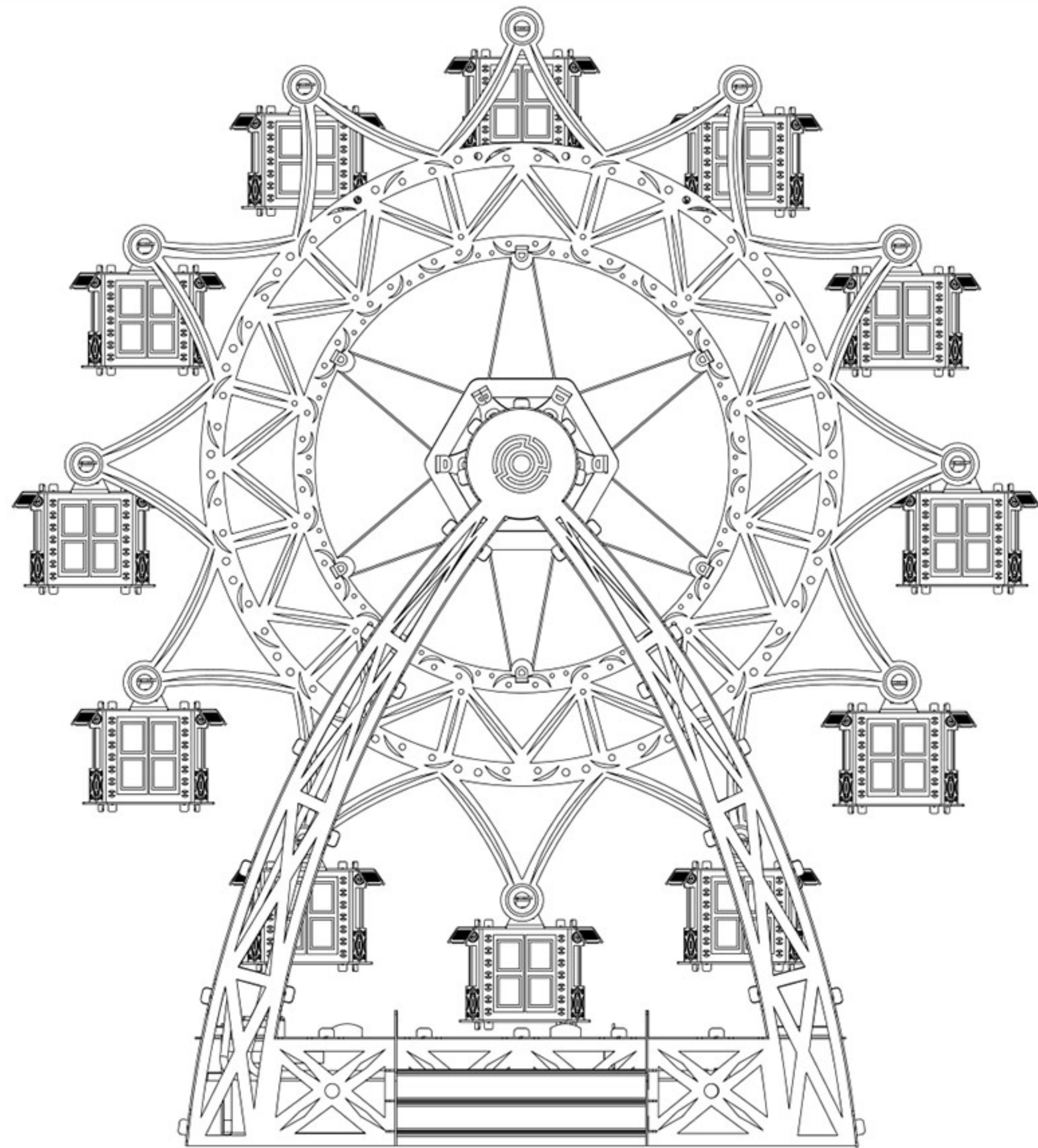





Model name:

## AMUSEMENT RIDE

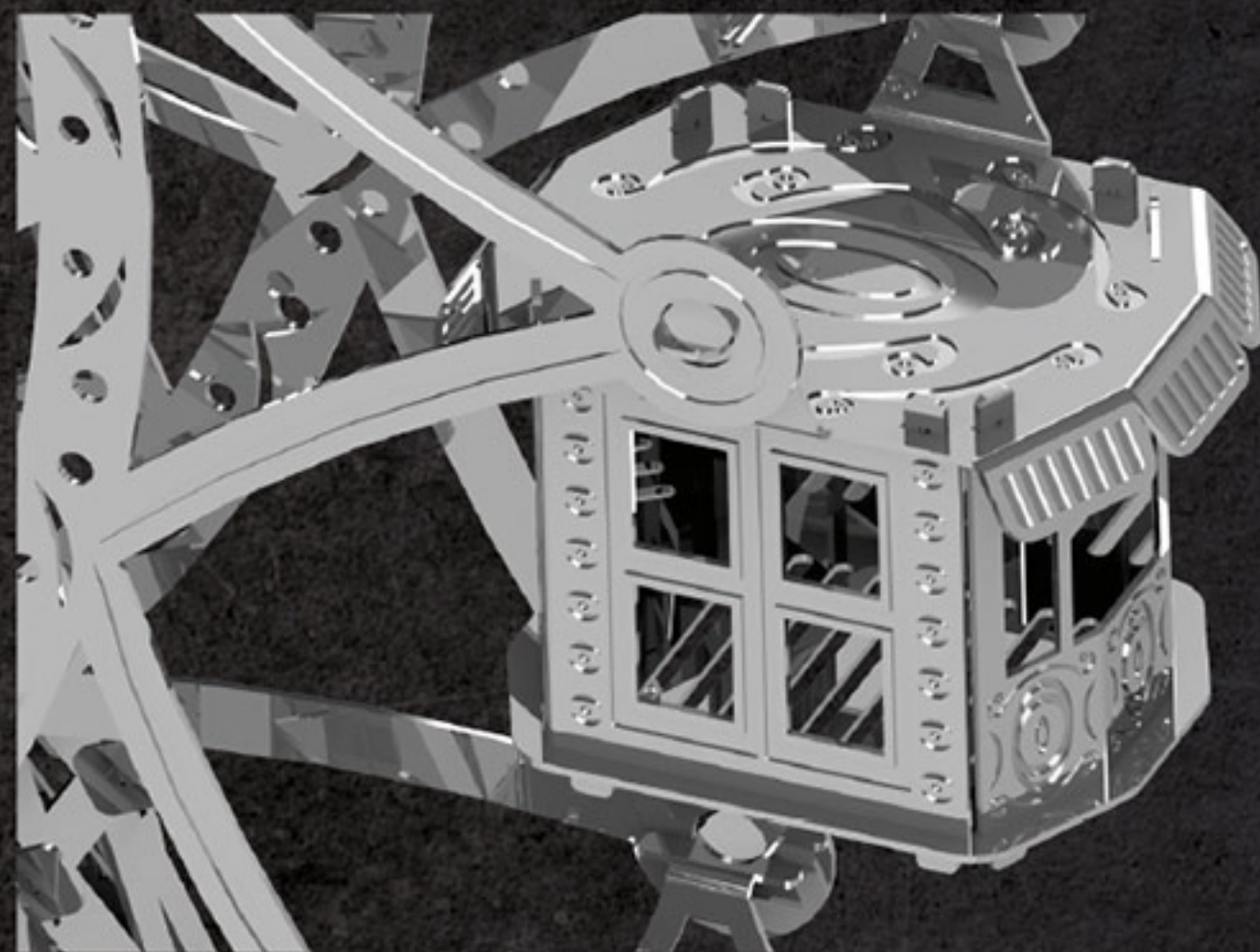

The Ferris wheel was invented by George W.G. Ferris Jr. He built the first one for the 1893 World's Fair, in Chicago, Illinois. Ferris owned a company that tested iron and steel for railroads and bridges. He used his knowledge of structural steel to

design a steel structure that would amaze the visitors to the fair. The first Ferris wheel was supported by two 140-foot tall steel towers, with a 45-foot long axle between them. The wheel had a diameter of 250 feet, and had 36 wooden cars that could each hold up to 60 riders. It was lit up by 3000 of Thomas Edison's new light bulbs. The first Ferris wheel was a huge success, and was considered a marvel of engineering.

Designed in Ukraine

 Made in China

Product number: SKU033

Product material: Stainless steel

Number of metal sheets: 3 pcs

Finish product size: L6.7" x W7.1" x H2.95" (L17cm x W18cm x H7,5cm)



**WARNING!**

The product contains small and/or sharp parts. Not suitable for children under 3 years of age.

In order to avoid possible injury from sharp edges, please carefully discard the metal sheet after parts have been removed. This product is not a toy. Keep out of reach of children.

Conforms to CPSIA and CE standards. The product complies with the requirements of EN 71-1,2,3; ASTM F963, REACH, AS/NZS 8124, GB 6675



Difficulty level

No expiration date

MODEL BUILDING KIT

@hobbadd.cn

霍布德



Collect the Best

Includes: steel sheets, pliers, file, gloves, polishing cloth, user's guide, electric motor, battery box. AAA batteries are not included. No expiration date

ALL RIGHTS RESERVED  
© Metal-Time Inc., USA

www.metal-time.com  
info@metal-time.com