

Thank you for purchasing this product.

Be sure to read this entire instruction manual before using this product.

Always keep the instruction manual with the product.

Instruction Manual

IWATANI cassette feu® Portable Butane Gas Stove

Listed by CSA

EcoPremium

Model: EPR-A

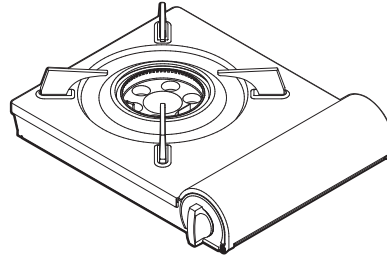

ANSI Z83.11-CSA 1.8-2016 Food Service Equip.

This appliance is for use indoors and outdoors in commercial restaurants.

 DANGER	<p>CARBON MONOXIDE HAZARD</p> <p>This appliance can produce carbon monoxide which has no odor. Using it in an enclosed space can kill you. Never use this appliance in an enclosed space such as a camper, tent, car or home.</p>	<p>MONOXYDE DE CARBONE</p> <p>Cet appareil peut produire du monoxyde de carbone, un gaz inodore.</p> <p>L'utilisation de cet appareil dans des espaces clos peut entraîner la mort.</p> <p>Ne jamais utiliser cet appareil dans un espace clos comme un véhicule de camping, une tente, une automobile ou une maison.</p>	
	<p>Warning</p> <p>Improper installation, adjustment, alteration, service or maintenance can cause injury or death. Read the installation, operating and maintenance instructions thoroughly before installing, operating or servicing this equipment.</p>	<p>MISE EN GARDE: Une installation, un réglage, une modification, une réparation ou un entretien inadéquat peut provoquer des dommages matériels, des blessures ou la mort. Lisez soigneusement les instructions d'installation, d'utilisation et d'entretien avant d'installer ou de réparer cet équipement.</p>	
 Caution	<p>When replacing fuel cylinder, be sure no sources of ignition are present</p>	<p>ATTENTION : Lors du remplacement de la bouteille d'alimentation en gaz, s'assurer qu'il n'y a aucune source d'inflammation à proximité</p>	
<p>FOR YOUR SAFETY</p> <p>If you smell gas:</p> <ol style="list-style-type: none"> 1. Do not attempt to light appliance. 2. Extinguish any open flame. 3. Disconnect from fuel supply. 4. Allow gas to dissipate 5 minutes before relighting the appliance. Failure to follow these instructions could result in fire or explosion, which could cause property damage, personal injury, or death. 	<p>POUR VOTRE SÉCURITÉ</p> <p>Que faire si vous sentez une odeur de gaz:</p> <ol style="list-style-type: none"> 1. Ne pas tenter d'allumer d'appareils. 2. Éteindre toute flamme. 3. Couper l'alimentation en gaz à la source. 4. Permettre au gaz de se dissiper pendant 5 minutes avant de rallumer l'appareil. Ne pas suivre ces instructions pourrait déclencher un incendie ou une explosion, ce qui causerait des dégâts matériels, des blessures ou la mort. 	<p>FOR YOUR SAFETY</p> <p>Do not store or use gasoline or other liquids with flammable vapors in the vicinity of this or any other appliance. </p>	<p>POUR VOTRE SÉCURITÉ</p> <p>Ne pas entreposer ni utiliser d'essence ni d'autres vapeurs ou liquides inflammables à proximité de cet appareil ou de tout autre appareil. </p>



Iwatani

Iwatani Corporation of America
 2200 Post Oak Boulevard, Suite 1150, Houston, TX, 77056
 www.iwatani.com

Using this product in a hazardous environment or for an unintended purpose may cause fire, injury and/or other unexpected accidents. Follow the instructions in this manual accordingly to ensure proper and safe use of this product.

<Before use>

In order to ensure safe and correct usage of this product as well as to prevent injury or physical damage to you and others, there are many symbols in the instruction manual to explain the product. The symbols and their meanings are explained below. Please ensure you have carefully read and understand the content before reading the main text.

 Danger	This symbol indicates matters that may lead to death, serious injury or fire if ignored or incorrectly handled.
 Warning	This symbol indicates matters that may lead to imminent risk of death or serious injury if ignored or incorrectly handled.
 Caution	This symbol is displayed along with instructions that, if ignored, and if the device is inappropriately used, may lead to the user suffering an injury or material damage.

These symbols have the following meanings



No more than 24 10-oz butane cylinders may be stored in a commercial restaurant except where a 2 hour fire wall is available. Where a 2 hour fire wall is available, an additional 24 10-oz. butane cylinders may be stored separated by the fire wall.

Dans un restaurant commercial, on ne peut conserver plus de 24 bouteilles de butane de 10 oz, sauf s'il est doté d'une cloison pare-feu offrant une résistance au feu de 2 heures. » Si le restaurant est doté d'une cloison pare-feu de 2 heures, on peut conserver, derrière cette cloison, bouteilles de butane de 10 oz de plus.

⚠ WARNING: This appliance must NEVER be used without the drip pan and grate provided with this appliance installed in their proper position. Attempting to cook without these parts in place may cause overheating of the fuel canister, resulting in a fire or explosion.

⚠ MISE EN GARDE: Cet appareil NE DOIT JAMAIS être utilisé sans le bac d'égouttage et la grille fournis avec cet appareil et installés dans leur position correcte. Essayer de cuire sans ces pièces en place peut provoquer une surchauffe de la cartouche de carburant pouvant causer un incendie ou une explosion.

FOR YOUR SAFETY

Do not store or use gasoline or other flammable vapors or liquids in the vicinity of this or any other appliance. 

MESURE DE SÉCURITÉ

Ne pas entreposer ni utiliser d'essence ni autres vapeurs ou liquides inflammables à proximité de cet appareil ou de tout autre appareil. 

If the unit is exposed to rain or snow you may have trouble lighting the burner until the burner ports are clear of water and the spark electrode is totally dry. To protect against burner ignition problems due to water accumulation, the storage box also serves as a rain guard when the stove is left outdoors and exposed to the elements. Never leave the stove outside without first storing it in the storage box provided. Remove butane canister before storage.

Caution on Product Degradation Over Time

Although rubber components are used for the product's gas connection points, rubber components degrade over time regardless of the frequency of use.

When this appliance is installed or used in a restaurant, the installation must conform with local codes and in the absence of local codes with NFPA 54, National Fuel Gas Code, ANSI Z223.1/NFPA 54 in the United States and in Canada with the Natural Gas and Propane Installation Code, CSA B149.1

This appliance is not for use at temperature below freezing (32°F / 0°C).

Names and Functions of Individual Parts

Names of display parts

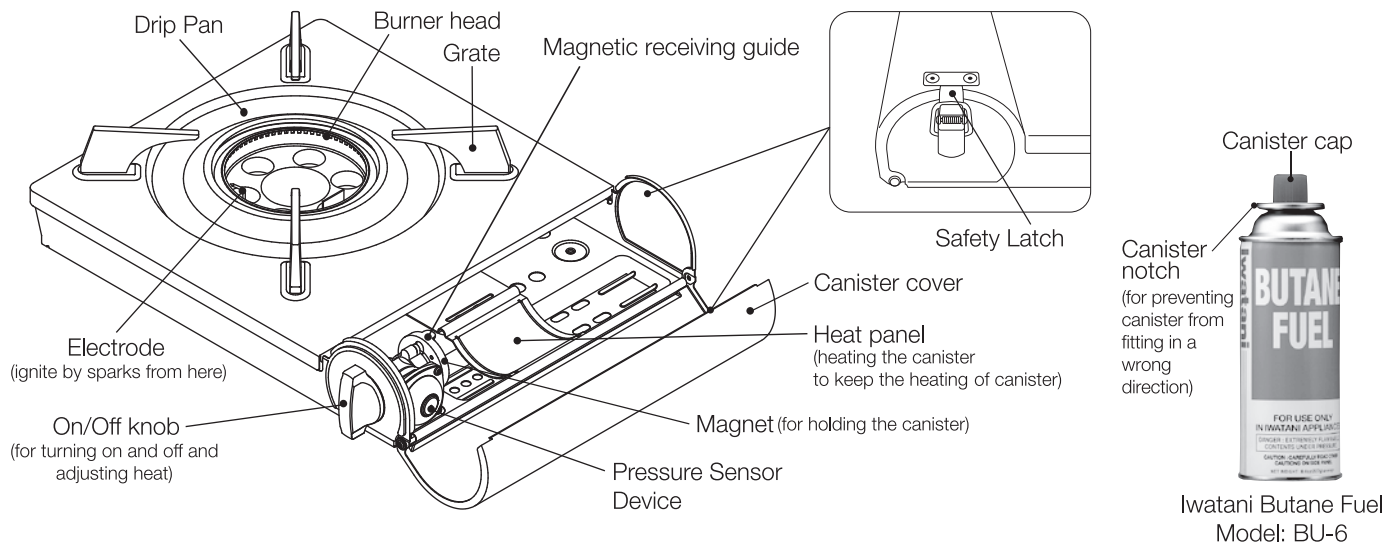

Features and Specifications for EcoPremium

Magnetic Locking System

The locking of the butane canister is done by simply lining the canister notch with the magnetic receiving guide and inserting. To remove, simply pull the butane canister away from the magnetic guide.

Heat Panel System

Through the heat panel, the heat of burner is transferred to the canister to increase the vaporization inside the canister maximizing energy output.
(Note, the canister will become hot. This is normal)

Safety Features

[1] Automatic Safety Shut-off

When the temperature of the main body becomes abnormally high, the safety mechanism automatically shuts off the gas supply by disconnecting the gas canister.

Treatment when Automatic Safety shut-off activates

- (1) Turn the switch to the "Off" position.
- (2) Remove the canister from the gas stove.
- (3) Refer to "Matters requiring special attention" to investigate potential issues.
- (4) Insert a new canister.
If there is no new canister, allow current canister to cool completely before reinserting.
If it is not cooled, Automatic Safety Shut-off may reactivate.
- (5) Turn the On/Off knob to the ON position. The product can now be used normally.

[2] Safety Canister Setting Device

Unless the knob is positioned at OFF position, you cannot connect the canister with the magnetic receiving guide.

Precaution when inserting a butane canister

Iron pieces or powders, if adhering to the magnet, may cause gas leaks or prevent the butane canister from being inserted. In this case, use adhesive tape to remove them.

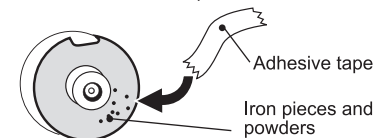

Ensure that no substance is adhering to the magnet when inserting a butane canister.

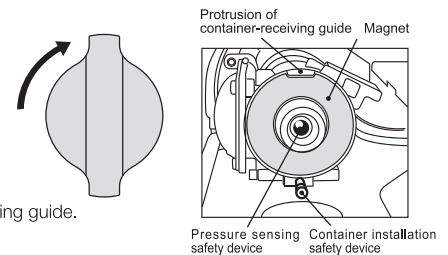

Main specification

Model name	cassette feu® EcoPremium
Model number	EPR-A
Ignition Type	Piezoelectric Ignition Type
Safety Features	Automatic Safety Shut-off Safety Canister Setting Device
Max external dimensions (in use)	13.1"/334mm (W) × 10.8"/274mm (D) × 3.5"/89mm (H)
Body weight	Approx. 3.31b/1.5kg (Canister not included)
Output (gas consumption)	10,000 BTU/h
Continuous combustion	With Iwatani Butane Fuel.: approx. 65 minutes <Maximum heating power and new canister used up. Temperature 68-77°F/20-25°C>
Canister	Iwatani Butane Fuel (BU-6) (only use Iwatani fuel as other brands may cause poor operation or safety issues). Contact Iwantani.com for where to purchase additional fuel canisters that meet Iwatani specifications for safe operation. The fuel cylinder must comply with UL 147B and must be marked in accordance with the U.S. Dept. of Transportation (DOT) for type 2P or 2Q fuel containers or Transport Canada. Iwatani fuel canisters meet these specifications.
Max size of pot available to use	Diameter of bottom of pot should be less than 11.5"/29cm. The outside of pot should not touch the canister cover (diameter of bottom of small pot should be more than 6"/16 cm.)
Minimum Clearance to combustible construction above and below cooktop surface is 6" (15.25cm) on right and left side and at the rear, and 36" (91 cm) above the cooktop. For installation on combustible flooring.	

Matters requiring special CAUTION

■ CAUTION: Overheating of Canister

⚠ Danger To prevent a fire or gas accident

● **If you notice a gas leak, extinguish the flame immediately**

When a gas leak occurs, a gas-like odor (similar to rotten onion) will be emitted. As butane gas is heavier than air and will collect at the bottom, avoid switching on an electric appliance or using fire, and immediately take the following actions. (There is a risk of explosion due to ignition.)

- ① Immediately extinguish the flame. (Switch the On/Off knob to the Off position)
- ② Remove the canister.
- ③ Open a window or door to let the leaked gas outside. (Do not use a ventilating fan).

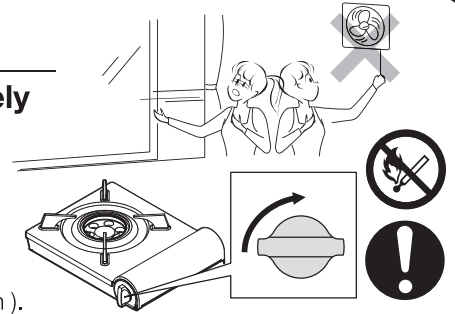

① Prevention of Overheating Canisters

⚠ Warning Be sure to follow the instructions below. Otherwise, the butane canister may over-heat, causing explosion and/or cause injury to yourself or others.

1) Do not heat empty cookware

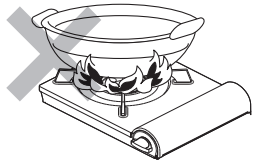

The body can become very hot and cause the canister to overheat and/or explode.



2) Do not use cookware that extends over the fuel canister cover.

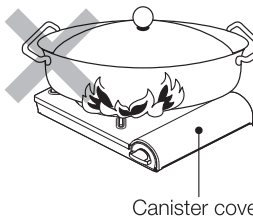

Canister cover

⚠ Warning: Using an oversized cooking utensil that extends over the fuel cartridge cover may result in over heating of the fuel canister and result in a fire or explosion.

When using a cooking utensil, make sure it is stable to avoid accident.



3) Do not use 2 or more units placed directly side-by-side

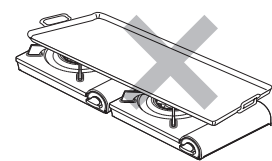

The body can become very hot and cause the canister to overheat and/or explode.



- It is very dangerous to use 2 products arrayed in parallel. Never attempt to do so.

4) Do not use the product for purposes such as starting a charcoal fire



Never use the product to start a fire by placing charcoal or a coal briquette on top. Radiation heat may overheat the canister and cause an explosion.



5) Do not use ceramic gridiron, porcelain board, ceramic or cookware with strong radiant heat etc. Also, never cover the grate and gridiron with aluminum foil

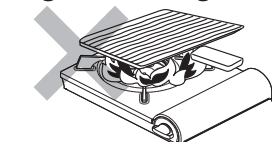

The body can become very hot and cause the canister to overheat and/or explode.



6) Do not use the product near other heat sources.

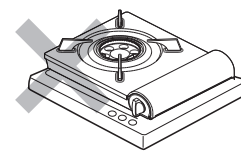

The body can become very hot and cause the canister to overheat and/or explode.



7) Do not use the product near open flames

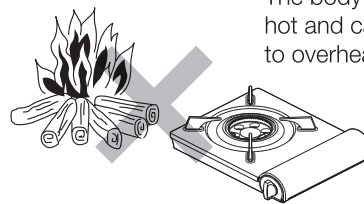

The body can become very hot and cause the canister to overheat and/or explode.



8) Do not use the product in a place where butane canister may overheat

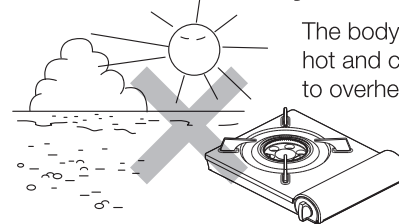

The body can become very hot and cause the canister to overheat and/or explode.



- When the temperature is very high, do not use or leave the product at a beach, on a gravel, asphalt covered surface or any other place where direct sunlight may overheat the canister.

9) Do not place items that burn easily or spare fuel containers around a canister-powered stove.



Doing so may cause fire or explosion.



10) Do not use the product with the drip pan removed

Doing so may cause the canister to overheat and explode.



Matters requiring special CAUTION

② Handling the Canister

Warning Be sure to follow the instructions below to avoid the risk of fire or explosion.

1) Do not put the canister near a heat source

Do not put the canister in a place near a heat source. The pressure inside the canister may cause the canister to explode.



2) When storing the canister, avoid flames and direct sunlight

Keep the canister with cap fitted in a place under 104F/40°C where it is airy and with little humidity. Keep away from flame and direct sunlight.



3) Do not throw the canister into a fire

Do not throw the canister into a fire. It will cause an explosion.



4) Proper disposal of canister.

- Empty canister should be disposed of according to the rules and regulations of your city/town. Make sure can is completely empty before disposing of it.
- Shake the canister, if there is liquid still inside, please use it up before disposing.



Caution

1) Please use dedicated canister.

Please use dedicated canister marked with "Iwatani Butane Fuel". If other canisters are used, it may cause gas leak or abnormality of operation.

2) Inhalation risk

Do not intentionally suck gas from the canister, as this may lead to suffocation or death due to lack of oxygen.

3) Do not subject the canister to strong impacts

The canister may become damaged or ignite due to a gas leak if it suffers an impact from a falling object.

4) Do not use deformed canisters

Doing so may lead to a gas leak.

5) Inspect stored canisters from time to time, always check that rusting canisters are free from gas leaks, and use them as soon as possible.

*Even if a canister does not exhibit rusting, do not use a canister that has been stored for an extended period (more than six or seven years as a rough guide).

Caution ● Instructions and warnings expressed on the canister should be read thoroughly.
● Before using, remove the cap. Before storing the canister, replace cap.

③ Circumstances where the product must not be used

Warning Using the product in the following places may cause fire or death. Never use the product in such places.

1) Do not use in cramped places and poorly ventilated places

Do not use the product inside a tent or a car. During use, the oxygen will be consumed which may cause death by suffocation due to a lack of oxygen and carbon monoxide poisoning. Also, it could start a fire.



2) Do not use near heat

Overheat may cause explosion.

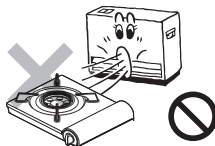

3) Do not use in unstable locations or on unstable ground

If the stove is tilted or moved during use, flames may become large and could cause injury or fire. There is also a danger of the stove tipping over. Use the product in flat locations with stable support.

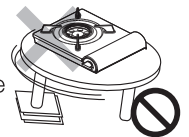

4) Do not use in strong wind

If the product is used in strong winds and the flame of the burner impinges on the stove casing, an accident may occur or the main unit may be damaged.



Caution

1) Do not use the product on a carpet or other heat-sensitive materials

This may cause deformation, melting or discoloration.

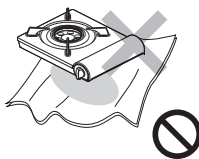

2) Do not use the product on top of another cooking or heat producing appliance such as a smokeless roaster.

This may cause the canister to overheat and it may explode

3) Do not use at a location where the base filled with pebbles or sand.

Radiation will worsen and the main unit may be damaged.



4) Do not use where a wind is blowing or where the wind is drawn in

The flame may flow sideways due to the wind or become mixed with the main unit, and burn the main unit or table.

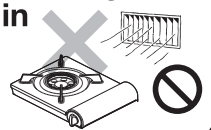

Matters requiring special CAUTION

④ To Avoid a Fire or Gas Leak

Warning The following operations of the product may cause the unit to overheat or explode. Never operate in the ways listed below.

1) Ventilate during use

Please make sure to turn on the ventilation fan during use. Using in a confined space may cause death by suffocation and/or carbon monoxide poisoning. The unit may only be used indoors in a restaurant with a properly equipped ventilation hood.

2) Never leave unit unattended while the unit is on.

Do not leave the stove unattended while it is lit. When disturbed due to a phone call or a visit, make sure to switch off the stove. Also take care not to forget to switch off the stove when preparing deep fried dishes thus avoiding a possible grease fire...

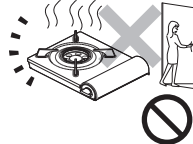

3) Do not use the product near an item that could easily catch on fire

Do not use the product near items that may catch fire, such as hairspray, gasoline or heating oil. Otherwise an explosion or fire may occur due to ignition.



4) Do not place spare canisters or hairspray containers nearby

When using the stove, do not place items that could easily burn, spare canisters, hairspray or similar items nearby. Otherwise ignition or explosion may occur.



5) The product should never be used by children

The product should never be used by children and please keep the product out of reach of children and pets.



6) When the stove does not ignite on the first attempt, be careful of ignition

Before igniting the second time, make sure there is no smell of gas. The escaped gas may cause a fire. Wait at least one minute before retries.



7) Never modify or disassemble the product

Disassembly could cause unexpected circumstances such as death from carbon monoxide poisoning or gas leaks, malfunction, or fire.



8) Do not use for purposes other than cooking

There is a risk of burns or fire due to overheating or abnormal burning.



9) Do not bring your face or hands close to the burner head of the stove

The flame may cause burns.



Caution

1) Fire protection treatment

During the use, keep the product more than 6"/15.25cm away from furniture, wall and other combustibles. Please allow 36"/91cm clearance above the unit to combustibles.

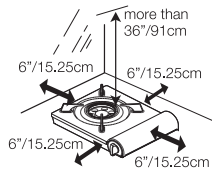

2) If the product is used on a table with heat-sensitive painting or lacquer, please place a non-combustible insulator beneath the appliance. (The bottom of gas stove becomes very hot during use, please be extra careful.)



3) Never put any combustibles, heat-sensitive materials or other objects (tablecloth, vinyl cloth, newspaper etc.) below the unit preventing ventilation and combustion air from getting to the burner. Do not block the bottom of the unit in any way nor any ventilation holes in the casing of the stove!

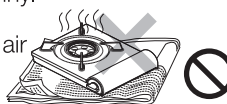

4) Do not place the product in proximity to curtains and similar materials, items that burn easily or items that are susceptible to heat

A fire may occur due to ignition of such items.



5) Never lean, tilt or move the product while in use

It may cause the unit to fall which may lead to an accident or a fire.



6) Do not use the product in danger from falling objects, such as under a shelf

Burns may occur due to ignition or cooking utensils falling over.

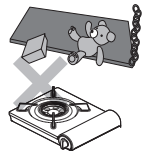

7) Do not use the product while inside its carrying case. In addition, do not stow the stove while at high temperature immediately after extinguishment

The case may deform due to the heat, or cause fire or burn injuries.



⑤ Other Cautions during Use

Caution

1) Do not use the stove as a substitute for drying clothes or as a heater

Falling clothes and other issues may lead to fire.

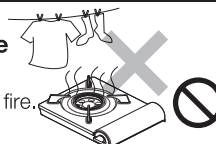

2) Take care to avoid a burn injury

During use and immediately after being switched off, the stove will be at a high temperature. Even after the stove has been switched off, avoid touching points other than the On/Off Knob for awhile.



3) In addition to lighting the stove when using it and extinguishing it after use, check from time to time that the stove is burning during use.



4) Always lock the Safety Latch during use.



5) Measures during abnormal operation

In the event the stove produces an abnormal sound, emits a strange odor, produces a red flame or in a similar emergency, calmly return the On/Off Knob to the "Off" position to extinguish the flame, remove the canister from the main unit, consult the "Troubleshooting a Malfunction" section on Page 6 and follow the instructions.



6) When cooking grilled meat and similar dishes, do not use products other than the "Expert Accessory Series"

Otherwise, burning of the stove or a similar accident may occur.



7) Whether or not the product is used, if the stove is old, we recommend requesting a (paid) inspection in the interests of safety.

*It may not be possible to perform repairs on products whose component retention period has expired.

How to Use

■ Checking the Site for Use

Check that the site for use is not one of the locations where the product should not be used as described on Page 3, and that it complies with the dangers, warnings the dangers, warnings and cautions described on Pages 2 and 4.

■ Preparation before Use

Follow the steps described below to fit a canister. Please be careful, as an incorrectly fitted canister could pose an unforeseen danger.

1) Fitting of canister

- Open the fuel canister cover.
- Turn the ON/OFF knob to the "OFF" position unless the knob is positioned off, you cannot fix the fuel canister in the stove.
- Make sure there is nothing stuck to the magnet.
- Please remove the canister cap and save for storage.
- Place the fuel canister with the canister notch facing up and set the fuel canister to the magnetic receiving guide by pushing the fuel canister until you hear it click into place.

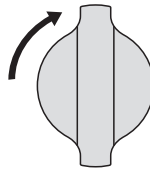

Magnetic receiving guide

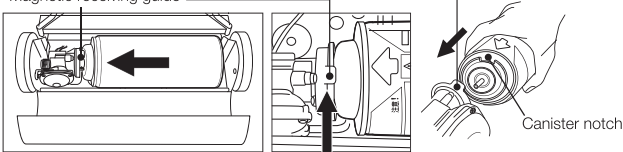

Please make sure there is no space between magnet and canister during the fitting.

- Once the canister is fitted, please close the fuel cover and lock the Safety Latch.



■ Turning on the Device

1) Ignition

- Turn the On/Off knob towards the "On" position until there is a click, and check that the stove is lit. If it is not lit, immediately return the knob to the "Off" position and repeat the ignition process.

*When the ignition fails several times, there may be a popping sound accompanied by a small burst of flame when the burner does finally ignite. Do not place your face or hand near the burner when igniting.

*Upon first use, the flame near the electrode will become red. This is normal and will dissipate after several uses.

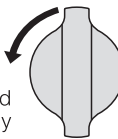

2) Adjusting the heating power

- Turning the knob towards the "On" position strengthens the heating power, while turning towards the "Off" position weakens it. When using low heat, make sure to check the flame as it will become difficult to see the flame.

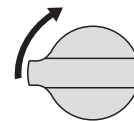
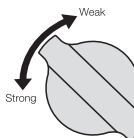

3) Turning off

- Please turn the ON/OFF knob to the "OFF" position.

4) Confirm flame goes out

- After use, check that the flame is completely out.
- *Allow unit to cool before removing canister. Just after use, the body and canister become extremely hot.
- *Always remove canister after each use. Failure to do so may result in gas leakage and/or a fire.

CAUTION: When replacing fuel cylinder, be sure no sources of ignition are present. (ATTENTION : Lors du remplacement de la bouteille d'alimentation en gaz, s'assurer qu'il n'y a aucune source d'inflammation à proximité.)

5) Removing the canister

- Open the fuel canister cover, hold the canister, apply slight pressure in the reverse direction of when the canister was fitted, and slide the canister horizontally away from the magnet.
- Make sure to reattach the cap before storing a removed canister.
- Close fuel canister cover and store canister with cap on until next use.

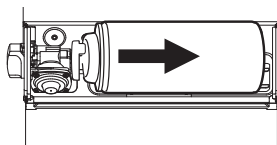

■ Read the following before the use

⚠ Warning

- Please confirm there is no gas leakage, the ignition is functioning properly and the ON/OFF knob is switched to the "OFF" position.
- Do not use if gas is leaking or igniter is not functioning.
- Never check for leaks with an open flame!

⚠ Warning

- Do not place any object between the bottom of the butane canister and the main body. The automatic safety shut-off device may not be able to operate. (See above figure marked X).

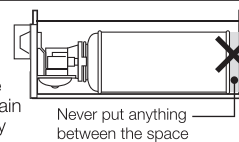

Never put anything between the space

⚠ Warning

- If the canister is not fitted correctly, it may cause gas leakage or a fire.

⚠ Caution

- If the ON/OFF knob is not turned to "OFF" position, the canister will not connect.

⚠ Caution

- When the force required to attach the butane canister is high, apply a thin coat of vegetable oil on the tip. (A in the figure on the right).



A The place to smear vegetable oil

⚠ Caution

- If the On/Off knob is turned to a position other than "Off" while the stove is not ignited, raw gas will be released and pose a danger.
- When beginning to use it may be difficult to ignite the stove if the canister is cold. Repeat the ignition process several times while exercising caution
- *When the ignition fails several times, there may be a popping sound accompanied by a small burst of flame when the burner does finally ignite. Do not place your face or hand near the burner when igniting.
- When the stove is ignited, the flame may burn away from the burner, but this is normal. Use the stove for 2-3 minutes with the On/Off Knob turned down slightly.

⚠ Caution

- Note that if the flame is too small, it can be easily blown out by the wind.

⚠ Caution

- After removing the canister, the gas lines of stove may still have some gas left in them. For your safety, please ignite again to use up the gas.

■ Removing and Refitting the Spill Cover

Wait until the stove has cooled down before removing the spill cover.

[Removing]

[Refitting]

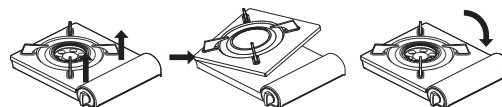

The drip pan can be removed by lifting up the drip pan and grate.

1) Align the rounded side of the drip pan with the arrow of the main unit.

2) Slip in the other side of the drip pan in the direction indicated by the arrow to refit

Daily inspection, maintenance and trouble shooting

Inspection and maintenance instructions

Inspection	Maintenance method	Precaution
Spillovers of food or liquid	Wipe off the spillover with a dry cloth. If the stain is obstinate, please use mild detergent. And wipe off totally with dry cloth.	Moisture and spillovers may cause malfunction, rust or failure. Please clean inside and outside frequently. Do not move electrode or flame rod.
If burner ports are blocked	Clean with a brush and/or small needle (Do not move electrode or flame rod.)	It may cause incomplete ignition or irregular flames. Please clean burner frequently.
Food particles on electrode (burner won't ignite)	Please remove particles from electrode with dry cloth. (Do not move the electrode)	If there is a stain on electrode it may cause hindered ignition. During maintenance, if ON/OFF knob rotates to ON position, it may cause electric shock.
Food residue on Stove	Please wipe off with dry cloth. If the stain is set, use mild detergent with water and then dry.	Do not use thinner, gasoline, polishing powder, nylon brush or metal brush. This may cause damage to the machine.

Attention

- Please use rubber gloves to protect your hands and fingers.
- Do not clean this product as a whole. If water gets inside, it may cause rust or gas blockage.
- Before inspecting, remove gas canister.
- Only perform maintenance on the unit when it is completely cool.
- Do not disassemble fuel gas line.
- If there is an over spillover during use, please clean burner.

Precautions when this product has not been used for a long time.

- Confirm there are no food particles causing blockage and the unit is dry.
- Separate the gas canister from the unit. Do not store when these two products are connected.
- When this product cools down, put into carrying case and store in a dry place. Never leave the unit outdoors without it being in the carrying case.
- Please perform regular inspection and maintenance to prevent product from rusting.
- Do not use any lubricants on this product.



Troubleshooting a Malfunction

In the event of an unexpected malfunction, troubleshoot by using the following information.

Problem	Cause													Solution	
	Hard to ignite	Cannot ignite	Burner would not stay lit	Yellow flames	Irregular flames	Flames are weak	Heating power is weak	There is a smell of gas	Flames go off during use	Flames don't go off	Canister cannot be fitted	Gas leaks even if ON/OFF knob is in the "OFF" position	Spark does not stop		Spark is not lit, even if the battery is new and placed properly
Use of canister from other companies	●							●			●	●			Please use Iwatani Butane Fuel
Little gas is left	●						●								Replace with a new canister
There is no gas left		●	●						●				●		The same as above
Electrode has food debris or moisture	●	●													Wipe off the stain/moisture
Burner head is clogged	●	●	●	●	●	●	●								Remove the clogging with metal brush etc.
Not igniting correctly	●	●						●							Ignite in a correct manner
The gas pipe (nozzle) is clogged		●	●	●	●	●	●		●						Apply for inspection & repair service
Failure of ON/OFF knob	●	●						●		●		●			The same as above
Automatic safety shut off switch activates		●											●		See Page "Treatment when Automatic Safety shut-off activates" to reset
Failure of ignition		●							●		●		●		Apply for inspection & repair service
ON/OFF knob is not turned to "ON" position							●		●						Turn ON/OFF knob to "ON" position completely
ON/OFF knob is not turned to "OFF" position											●				Turn ON/OFF knob to "OFF" position completely
Canister is not fitted properly		●						●			●	●			See "Fitting of the canister" in How to use section.
Debris is stuck to magnet											●				Remove the debris
Deformation /distortion of the body											●				Apply for inspection & repair service

The following cases are not malfunction

If there are the following failures during use, they are not abnormalities. Please use proper treatment as shown below.

Problem	Reasons	Solution
<ul style="list-style-type: none"> ■ Hard to ignite ■ The sparks from electrode don't jump to the burner or jumps to places other than the burner. 	<ol style="list-style-type: none"> 1) The electrode and burner don't align with each other. 2) The white part (ceramic) of electrode has a drop of water or a stain. 	<ul style="list-style-type: none"> ● Move electrode closer to burner head and then ignite. Make sure burner is completely cool before attempting. ● Clean or dry the electrode. Moisture causes the electric spark to misalign with burner head.
<ul style="list-style-type: none"> ■ There is still gas left but the flames go out. 	<ol style="list-style-type: none"> 1) Canister becomes hot because of inappropriate operation, and Automatic Safety Shut-off activates. 	<ul style="list-style-type: none"> ● See Page 1, "Treatment when Automatic Safety shut-off activates".
<ul style="list-style-type: none"> ■ Canister cannot be fitted to magnetic locking guide. It comes off immediately even if fitted. 	<ol style="list-style-type: none"> 1) Canister is too hot , and Automatic Safety Shut-off activates. 2) A foreign substance is stuck to the magnet. 3) ON/OFF knob is not turned to OFF position. 	<ul style="list-style-type: none"> ● See Page 5 "Fitting of canister" Remove the foreign substance from the magnet. ● Turn the ON/OFF knob to OFF position completely.
<ul style="list-style-type: none"> ■ During the first use after purchase, the flames around the electrode get red 	—	<ul style="list-style-type: none"> ● No treatment. This is completely normal and will dissipate after several uses.

The operating manifold pressure is 1.05psi±10%
Contact Iwatani.com for information concerning service or repairs.