

ASSEMBLY INSTRUCTION CT002

DESCRIPTION

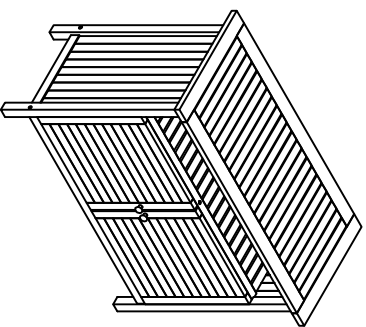

HARDWARE CT 002

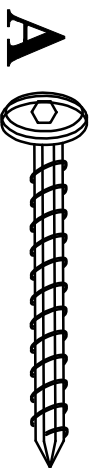

M6 x 60 : 08 PCS

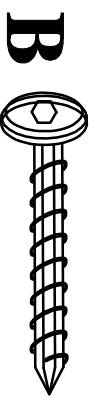

M6 x 40 : 04 PCS

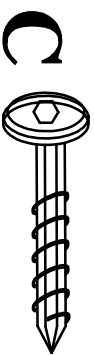

M6 x 30 : 3 PCS



1 PCS

①

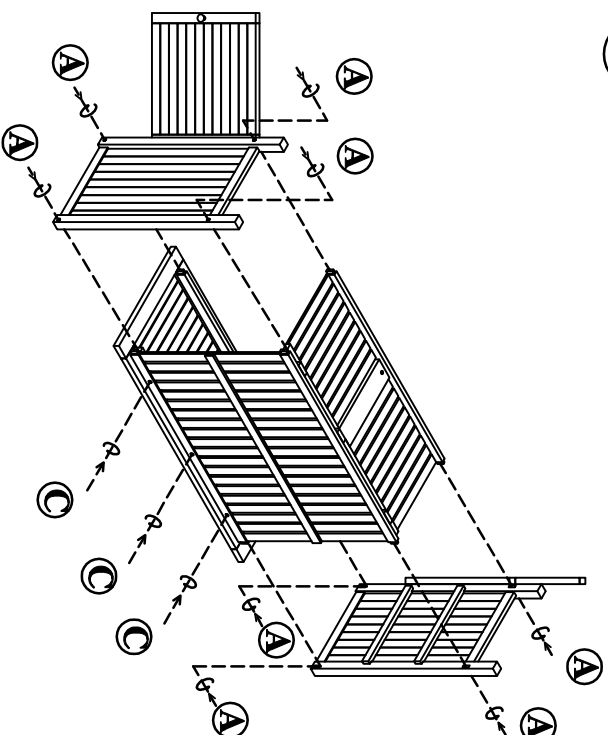

②

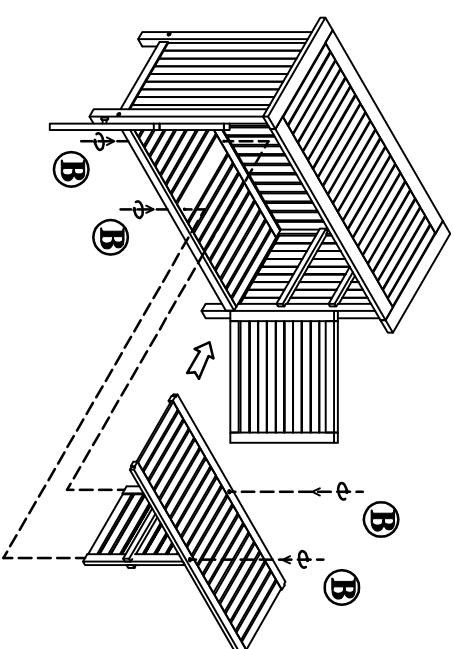

③

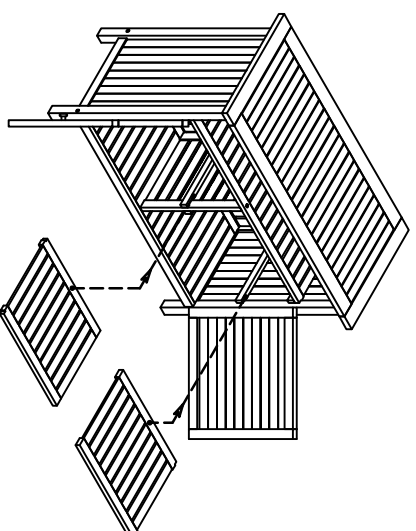

④

